

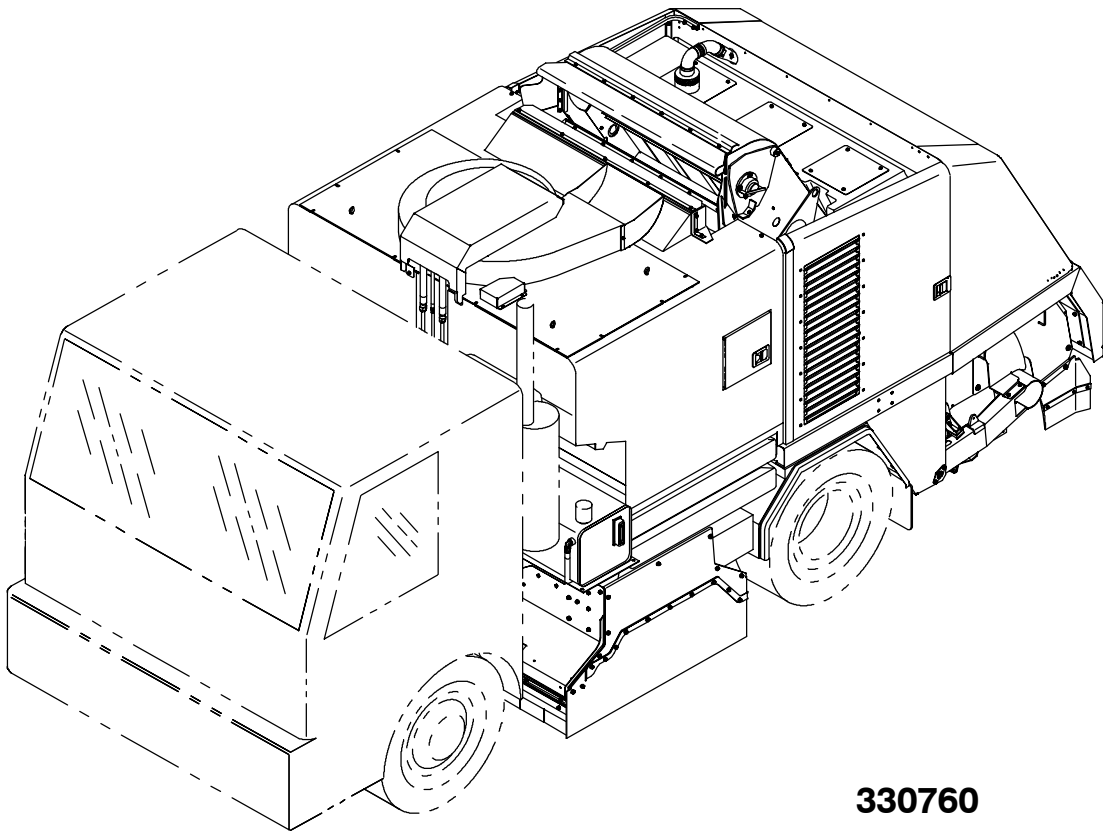

# CENTURION™

Operator Manual  
(000000-002000)



330760  
Rev. 03





This manual is furnished with each new TENNANT Model Centurion™. It provides necessary operating and preventive maintenance instructions. Read this manual completely and understand the machine before operating or servicing it.

This machine will provide excellent service. However, the best results will be obtained at minimum costs if:

- The machine is operated with reasonable care.
- The machine is maintained regularly – per the maintenance instructions provided.
- The machine is maintained with TENNANT supplied or equivalent parts.

Manual Number – 330760

Revision: 03

Published: 10-03



**CALIFORNIA PROPOSITION 65 WARNING: Engine exhaust from this product contains chemicals known to the State of California to cause cancer, birth defects, or other reproductive harm.**

**CONTENTS**

	Page		Page
SAFETY PRECAUTIONS .....	4	BRUSH WEAR INDICATOR .....	27
OPERATION .....	8	WATER FLOW SWITCH .....	28
OPERATOR RESPONSIBILITY .....	8	WATER TANK LEVEL GAUGE .....	28
MACHINE COMPONENTS .....	9	FILTER SHAKER SWITCH .....	29
CONTROL PANEL SYMBOLS .....	10	VACUUM FAN SWITCH .....	30
CONTROLS AND INSTRUMENTS .....	11	LEFT SIDE GUTTER BROOM	
RIGHT HAND STEERING INSTRUMENT		SWITCH (OPTION) .....	30
CONSOLE .....	11	RIGHT SIDE GUTTER BROOM	
UPPER CONTROL PANEL		SWITCH .....	30
SWITCHES .....	12	HOPPER UP SWITCH .....	31
CENTER CONTROL PANEL		HOPPER DOWN SWITCH .....	31
SWITCHES .....	13	HOPPER DUMP SWITCH .....	32
TOUCH PANEL .....	14	HOPPER HOME SWITCH .....	32
OPERATION OF CONTROLS .....	15	CONVEYOR IN SWITCH .....	33
IGNITION SWITCH .....	15	CONVEYOR FORWARD SWITCH ...	33
PARKING BRAKE KNOB .....	15	CONVEYOR REVERSE SWITCH ...	33
OPERATOR CONTROL SWITCH ...	15	CONVEYOR OUT SWITCH .....	34
REAR AXLE CONTROL SWITCH ...	16	CONVEYOR WATER SPRAY SWITCH	34
FAST IDLE SWITCH .....	16	FRONT WATER SPRAY SWITCH ...	35
HEATED MIRROR SWITCH (OPTION)	16	LEFT SIDE WATER SPRAY SWITCH	35
PUSHBUTTON RANGE SELECTOR .	17	RIGHT SIDE WATER SPRAY SWITCH	35
PTO KILL SWITCH (For machines below		FUSES (For Machines below	
serial number 00XXXX) .....	17	serial number 001040) .....	36
PTO KILL SWITCH (For machines serial		FUSES (For Machines	
number 00XXXX and above) .....	17	serial number 001040 and above) .	37
REAR WORK LIGHT SWITCH		LEFT SIDE GUTTER BROOM TILT	
(OPTION) .....	18	SWITCH (OPTION) .....	38
HOPPER WORK LIGHT SWITCH		RIGHT SIDE GUTTER BROOM TILT	
(OPTION) .....	18	SWITCH (OPTION) .....	38
RIGHT SIDE INSTRUMENT CONSOLE	18	GUTTER BROOM SPEED/PRESSURE	
TACHOMETER .....	19	ADJUSTMENT (OPTION) .....	38
SPEEDOMETER .....	19	REVOLVING LIGHT SWITCH	
ENGINE OIL PRESSURE GAUGE ..	20	(OPTION) .....	39
ENGINE COOLANT TEMPERATURE		GUTTER BROOM LIGHT SWITCH	
GAUGE .....	20	(OPTION) .....	39
VOLTMETER .....	20	LATCHES .....	39
FUEL LEVEL GAUGE .....	21	HOPPER TILT SUPPORT BAR .....	40
TRANSMISSION TEMPERATURE		HOPPER LIFT SUPPORT BARS .....	40
GAUGE .....	21	ALARMS .....	41
AIR BRAKE PRESSURE GAUGE ...	21	HOPPER UP ERROR ALARM .....	41
BRIGHT HEADLIGHTS LIGHT .....	22	CONVEYOR NOT BACK ALARM .....	41
PREHEAT LIGHT .....	22	CONVEYOR STALL ALARM .....	41
SIGNAL LIGHT .....	22	HOPPER FIRE ALARM .....	42
TOUCH PANEL .....	23	TANK LOW, PUMP OFF ALARM .....	42
START UP SCREEN .....	23	REDUCE ENGINE RPM ALARM .....	42
DISPLAY CLOCK .....	23	CHECK HYDRAULIC FILTER ALARM	43
HOURMETER .....	24	WORN MAIN BRUSH ALARM .....	43
BRUSH HOURMETER .....	24	ACTIVATE PARK BRAKE ALARM ...	43
MORE SWITCH .....	24	SHAKE FILTER ALARM .....	44
PTO SWITCH .....	25	OVERSPEED ENGINE ALARM .....	44
SWEEP SWITCH .....	26	OVERSPEED TRAVEL ALARM .....	44
SWEEP MODE SWITCH .....	27	MACHINE NOT LEVEL ALARM .....	45
SUPER SWEEP SWITCH .....	27	HYDRAULIC FLUID LOW ALARM ...	45

# CONTENTS

	Page		Page
HOW THE MACHINE WORKS .....	46	HYDRAULICS .....	82
PRE-OPERATION CHECKLIST .....	46	HYDRAULIC FLUID RESERVOIR ...	82
STARTING THE MACHINE .....	47	HYDRAULIC FLUID .....	83
SWEEPING AND BRUSH INFORMATION	49	HYDRAULIC PUMP LOAD SENSE	
SWEEP MODES .....	50	FILTERS .....	84
SETTING THE CUSTOM MODE .....	51	CHECKING THE LOAD SENSE	
FILLING THE WATER TANK .....	52	FILTERS .....	84
SWEEPING .....	54	HYDRAULIC FLUID FILTER .....	85
STOP SWEEPING .....	56	HYDRAULIC COOLING SYSTEM ...	85
EMPTYING THE HOPPER .....	57	HYDRAULIC HOSES .....	85
STOPPING THE MACHINE .....	59	ENGINE .....	86
POST-OPERATION CHECKLIST .....	60	AIR FILTER RESTRICTION	
OPERATION ON INCLINES .....	60	INDICATOR .....	86
ENGAGING HOPPER TILT		ENGINE AIR CLEANER .....	86
SUPPORT BAR .....	61	ENGINE VALVES .....	86
DISENGAGING HOPPER TILT		TRANSMISSION .....	87
SUPPORT BAR .....	63	TRANSMISSION ACCESS .....	87
ENGAGING HOPPER LIFT		REMOVING DRY DUST CONTROL	
SUPPORT BARS .....	65	ASSEMBLY .....	87
DISENGAGING HOPPER LIFT		WET DUST CONTROL SYSTEM .....	91
SUPPORT BARS .....	67	WATER TANK .....	91
MACHINE TROUBLESHOOTING .....	69	WATER PUMP .....	91
MAINTENANCE .....	71	WATER FILTER .....	92
MAINTENANCE CHART .....	72	WATER HOSES .....	92
LUBRICATION .....	74	SPRAY NOZZLES .....	92
HOPPER LIFT/TILT .....	74	DEBRIS HOPPER .....	93
ENGINE .....	74	THERMO SENTRY™ .....	93
GUTTER BROOM SUPPORT RODS	75	HOPPER DUST FILTER .....	93
GUTTER BROOM SUPPORT ARMS	75	RINSING THE HOPPER DUST	
GUTTER BROOM PIVOT .....	75	FILTER .....	94
DUST CONTROL SKIRT CYLINDER		TO REMOVE OR REPLACE HOPPER	
(OPTION) .....	76	DUST FILTER .....	95
DUST CONTROL SKIRT PIVOTS		CONVEYOR .....	97
(OPTION) .....	76	ADJUSTING CONVEYOR HEIGHT ..	98
DUST CONTROL BUMPER PIVOTS		FLUSHING THE CONVEYOR BELT .	99
(OPTION) .....	76	ADJUSTING CONVEYOR BELT	
MAIN BRUSH SUPPORT ARMS ....	77	TRACKING .....	100
MAIN BRUSH IDLER BEARING ....	77	TO REPLACE THE CONVEYOR BELT	102
DRAG SHOE PIVOT .....	77	BRUSHES .....	105
MAIN BRUSH LIFT CYLINDER ....	78	MAIN BRUSH .....	105
DRAG SHOE LIFT CYLINDER .....	78	TO REPLACE THE MAIN BRUSH	105
MAIN BRUSH AND DRAG SHOE		TO CHECK AND ADJUST MAIN	
CYLINDERS .....	78	BRUSH PATTERN .....	109
CONVEYOR BEARINGS .....	79	GUTTER BROOM(S) .....	110
CONVEYOR LIFT CYLINDERS .....	79	TO REPLACE THE GUTTER	
CONVEYOR TILT CYLINDER .....	80	BROOM(S) .....	110
DRY DUST CONTROL SKIRT WING		TO CHECK AND ADJUST THE	
PIVOTS (OPTION) .....	80	GUTTER BROOM PATTERN ..	111
PROPULSION SHAFT SLIP JOINT ..	80		
AUTO LUBE (OPTION) .....	81		

	Page
SKIRTS AND SEALS .....	113
BRUSH COMPARTMENT SIDE	
SKIRT .....	113
BRUSH COMPARTMENT REAR	
SKIRT .....	113
TOP CONVEYOR SKIRTS .....	113
BOTTOM CONVEYOR SKIRTS .....	114
HOPPER CHUTE DOOR SKIRT ....	114
HOPPER CHUTE DOOR SEALS ....	114
HOPPER ACCESS DOOR SEAL ....	115
HOPPER FILTER COVER SEAL ....	115
VACUUM DUCT SEALS (OPTION) ..	115
ACCESS PANEL DUST SKIRTS	
(OPTION) .....	116
FRONT DRY DUST CONTROL SKIRTS	
(OPTION) .....	116
CENTER DRY DUST CONTROL SKIRT	
(OPTION) .....	116
REAR DRY DUST CONTROL SKIRTS	
(OPTION) .....	117
DRY DUST CONTROL WING SKIRTS	
(OPTION) .....	117
DRY DUST CONTROL GUTTER BROOM	
SKIRT(S) (OPTION) .....	117
DRAG SHOES .....	118
MACHINE JACKING .....	119
STORING MACHINE .....	119
FREEZE PROTECTION FOR WET DUST	
CONTROL SYSTEM .....	119
TRANSPORTING THE MACHINE .....	120
SPECIFICATIONS .....	122
GENERAL MACHINE	
DIMENSIONS/CAPACITIES .....	122
GENERAL MACHINE PERFORMANCE .	123
POWER TYPE .....	123
STEERING .....	123
HYDRAULIC SYSTEM .....	123
BRAKING SYSTEM .....	123
MACHINE DIMENSIONS .....	124
INDEX .....	125

## SAFETY PRECAUTIONS

The following precautions are used throughout this manual as indicated in their description:

 **WARNING: To warn of hazards or unsafe practices which could result in severe personal injury or death.**

**FOR SAFETY: To identify actions which must be followed for safe operation of equipment.**

The machine is suited to sweep disposable debris. Do not use the machine other than described in this Operator Manual.

The following information signals potentially dangerous conditions to the operator or equipment:

 **WARNING: Burn Hazard. Hot Surface. Do Not Touch.**

 **WARNING: Raised hopper may fall. Engage hopper support bar.**

 **WARNING: Tilted hopper may fall. Engage hopper support bar.**

 **WARNING: Brush linkage pinch points. Stay clear when linkage is moving.**

 **WARNING: Side brush can move. Do not step on side brush.**

 **WARNING: High dump vertical clearance. Stay clear of overhead obstructions and power lines.**

 **WARNING: Conveyor throws debris. Conveyor pinch point. Stay clear when in operation.**

 **WARNING: Flammable materials can cause explosion or fire. Do not use flammable materials in tank. Only use water.**

 **WARNING: Lift arm pinch point. Stay clear of hopper lift arms.**

 **WARNING: Loss Of Steering Control Can Result. Stop Machine And Place In Neutral Before Switching Operator Control.**

 **WARNING: Engine emits toxic gases. Severe respiratory damage or asphyxiation can result. Provide adequate ventilation. Consult with your regulatory agency for exposure limits. Keep engine properly tuned.**

 **WARNING: Rotating PTO Shaft. Never Get Under Machine If Engine Is Running.**

### FOR SAFETY:

1. **Do not operate machine:**
  - Unless trained and authorized. This machine requires an updated Commercial Drivers License for operation.
  - Unless all TENNANT and truck manuals are read and understood.
  - In flammable or explosive areas.
2. **Before starting machine:**
  - Check for fuel leaks.
  - Keep sparks and open flame away from refueling area.
  - Make sure all safety devices are in place and operate properly.
  - Check brakes and steering for proper operation.
3. **When using machine:**
  - Use brakes to stop machine.
  - Go slow on inclines and slippery surfaces.
  - Use care when reversing machine.
  - Do not move machine when hopper is raised.
  - Only dump the hopper on a level surface.
  - Make sure adequate clearance is available before raising hopper.
  - Do not carry riders on machine.
  - Always follow safety and traffic rules.
  - Report machine damage or faulty operation immediately.
4. **Before leaving or servicing machine:**
  - Stop on level surface.
  - Set parking brake.
  - Turn off machine and remove key.

5. **When servicing TENNANT sweeping components:**
  - **Avoid moving parts. do not wear loose jackets, shirts, or sleeves.**
  - **Block machine tires before jacking machine up.**
  - **Jack machine up at designated locations only. Block machine up with jack stands.**
  - **Use hoist or jack that will support the weight of the machine.**
  - **Wear eye and ear protection when using pressurized air or water.**
  - **Disconnect battery connections before working on machine.**
  - **Avoid contact with battery acid.**
  - **Keep flames and sparks away from fuel system service area. Keep area well ventilated.**
  - **Use cardboard to locate leaking hydraulic fluid under pressure.**
  - **Use Tennant supplied or approved replacement parts.**
  
6. **When loading/unloading machine onto/off truck or trailer:**
  - **Turn off machine.**
  - **Use truck or trailer that will support the weight of the machine.**
  - **Use winch. Do not drive the machine onto/off the truck or trailer unless the load height is 380 mm (15 in) or less from the ground.**
  - **Set parking brake after machine is loaded.**
  - **Block machine tires.**
  - **Tie machine down to truck or trailer.**

# SAFETY PRECAUTIONS

The following safety labels are mounted on the machine in the locations indicated. If these or any label becomes damaged or illegible, install a new label in its place.

**FOR SAFETY LABEL -**  
Located on the upper console.



**HOT SURFACE LABEL -**  
Located on the side of the hydraulic tank.



**BRUSH LINKAGE LABEL -**  
Located on each main brush lift arm, gutter broom and next to main brush lift cylinders.



**ROTATING PTO SHAFT LABEL -**  
Located on the upper console and on the side of the machine.



**SIDE BRUSH LABEL -**  
Located on top of the side brush(es).

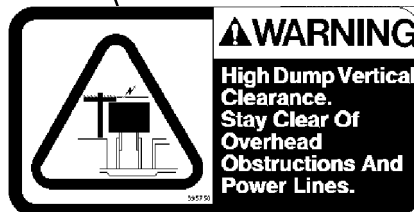

**HIGH DUMP LABEL -** Located on the upper console and on the side of the machine.



**CONVEYOR LABEL -**  
Located on each side of the conveyor.



**LIFT ARMS LABEL (High Dump) -**  
Located on the side of the hopper lift.



**HOPPER SUPPORT BAR LABEL (Low Dump) -** Located on both sides of the scissor lift in the lower rail.



**FLAMMABLE MATERIALS LABEL -**  
Located on the right side of the machine behind the water hose shields.



**OPERATOR CONTROL SWITCH LABEL -**  
Located on the control panel between the operator seats.



**HOPPER SUPPORT BAR LABEL (High Dump) -** Located on both sides of the scissor lift in the lower rail.

### OPERATOR RESPONSIBILITY

- The operator's responsibility is to take care of the daily maintenance and checkups of the machine to keep it in good working condition. The operator must inform the service mechanic or supervisor when the required maintenance intervals occur as stated in the *MAINTENANCE* section of this manual.
- This machine requires a Commercial Drivers License for operation. Keep updated with all licenses and machine operation training.
- Read this manual carefully before operating this machine. Review all of the training materials supplied with the machine.

**FOR SAFETY: Do not operate machine, unless operation manual is read and understood.**

- Check the machine for shipping damage. Check to make sure machine is complete per shipping instructions.
- Keep your machine regularly maintained by following the maintenance information in this manual and all other truck manuals supplied with the machine. We recommend taking advantage of a regularly scheduled service contract from your TENNANT representative.
- Order parts and supplies directly from your authorized TENNANT representative. Use the parts manual provided when ordering parts.
- The model CENTURION™ has a GVWR of 14,850 kg (33,000 lb), 4536 kg (12,000 lb) front axle and 9450 kg (21,000 lb) rear axle. Operate only on surfaces capable of supporting this weight.

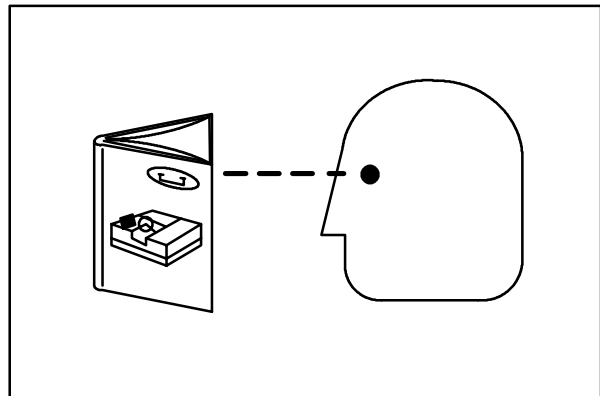

07324

## MACHINE COMPONENTS

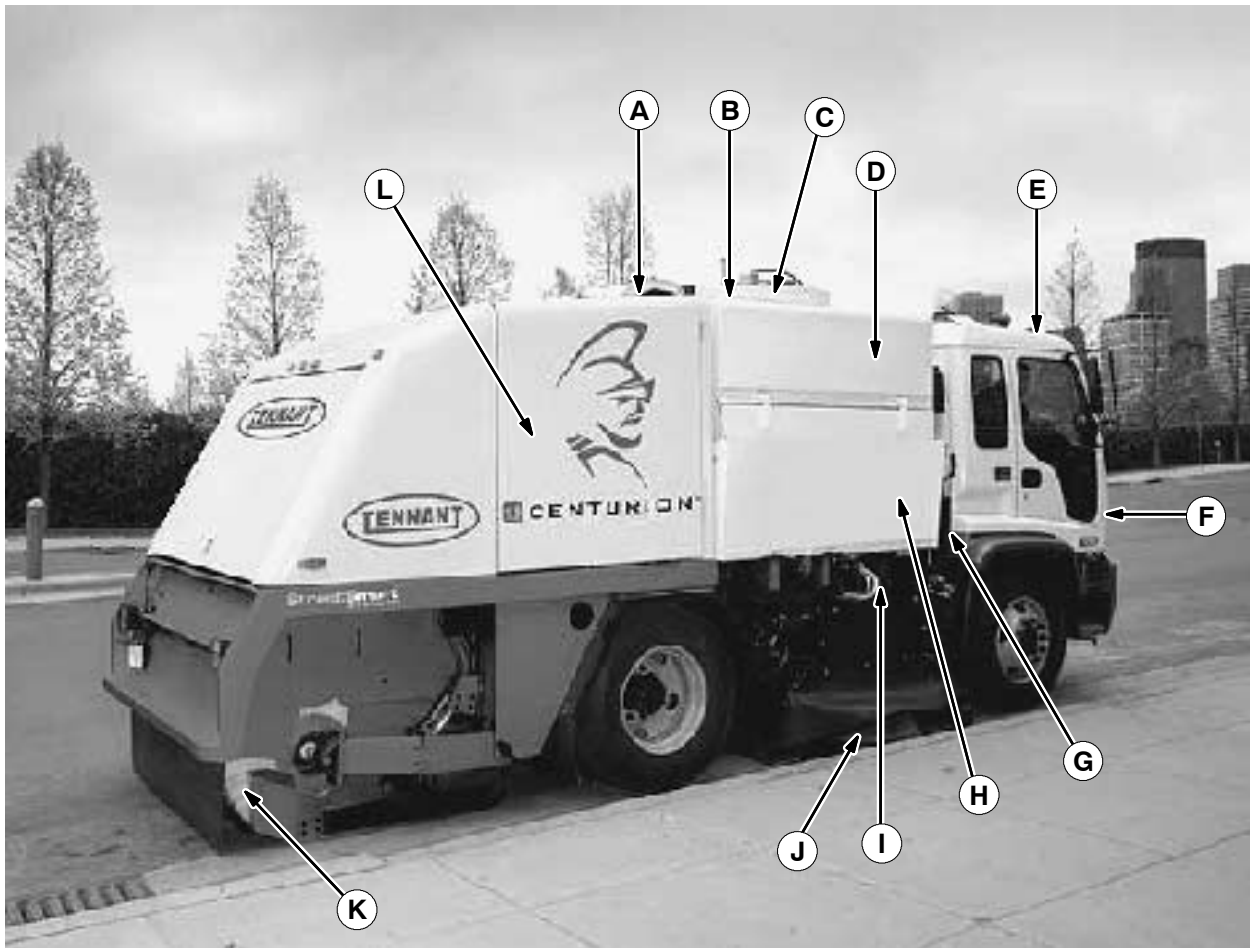

- A. Conveyor
- B. Dust Filters
- C. Vacuum Fan
- D. Hopper
- E. Cab
- F. Diesel Engine
- G. Fuel Tank
- H. Hopper Door
- I. Hopper Lift
- J. Gutter Brooms
- K. Main Brush
- L. Water Tank

## CONTROL PANEL SYMBOLS

---

These symbols identify controls and displays on the machine:



Right Side Gutter Broom Light



Left Side Gutter Broom Light



Revolving Light



Fuel



Bright Headlights



Signal Lights



Air Inlet Heater (Preheat)

---

**CONTROLS AND INSTRUMENTS**

---

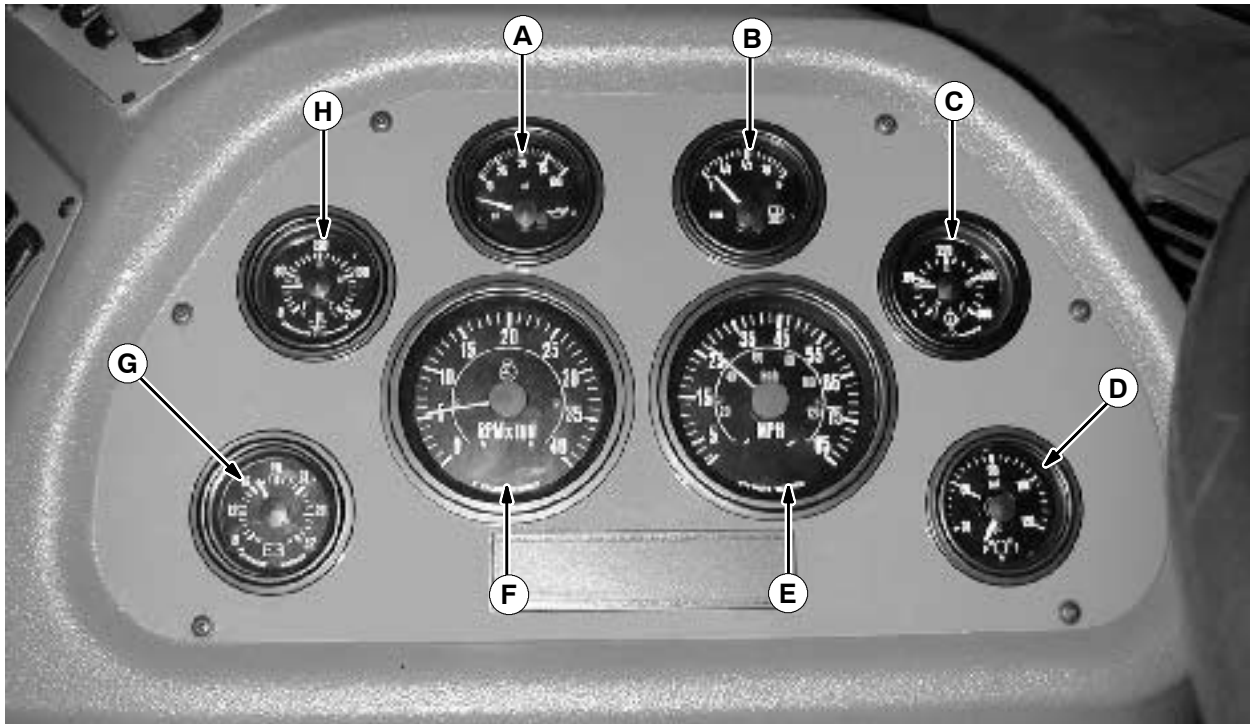
**RIGHT HAND STEERING INSTRUMENT CONSOLE**

- A. Oil Pressure Gauge
- B. Fuel Gauge
- C. Transmission Temperature Gauge
- D. Air Brake Pressure Gauge
- E. Speedometer
- F. Tachometer
- G. Voltmeter
- H. Coolant Temperature Gauge

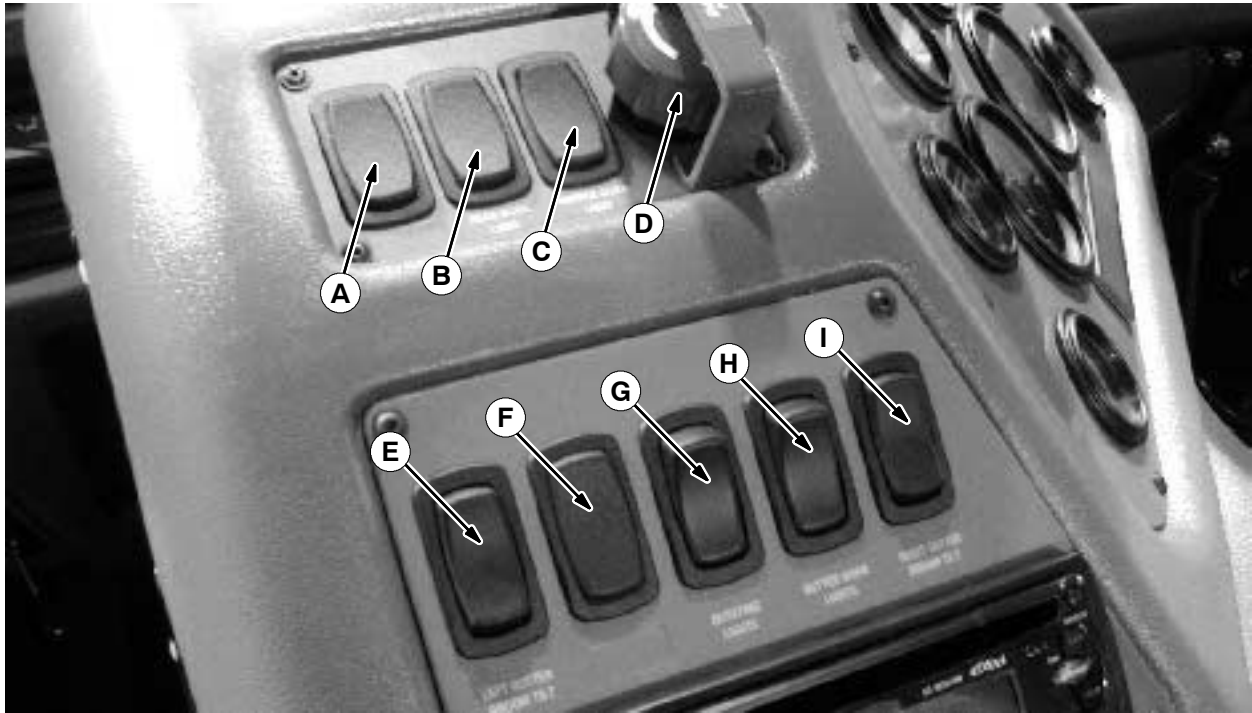

## UPPER CONTROL PANEL SWITCHES

- A. Open
- B. Rear Work Light
- C. Hopper Work Light
- D. PTO (Power Take Off) Kill Switch
- E. Left Side Gutter Broom Tilt Switch (Option)
- F. Open
- G. Revolving Light Switch (Option)
- H. Gutter Broom Work Lights
- I. Right Side Gutter Broom Tilt Switch (Option)

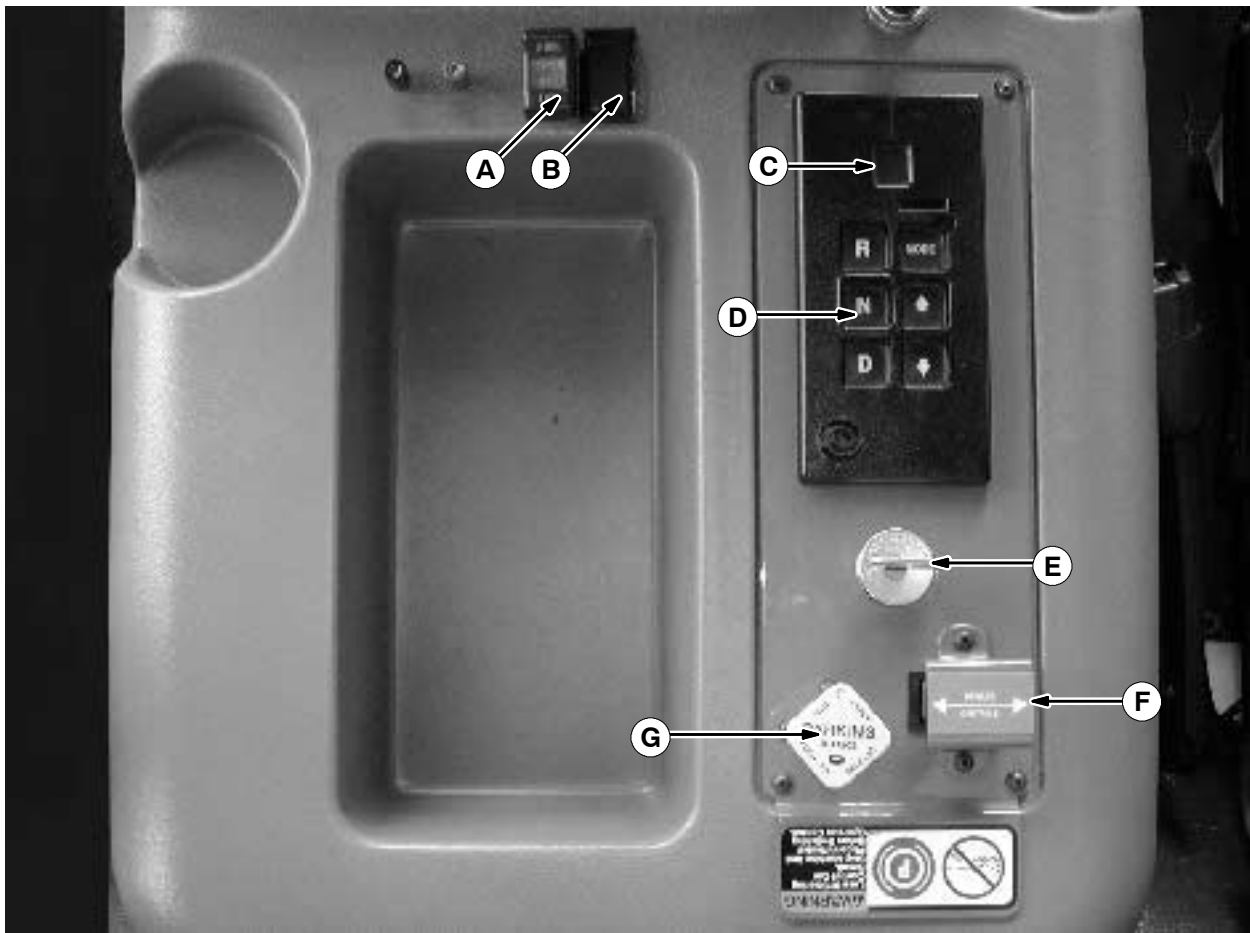

### CENTER CONTROL PANEL SWITCHES

- A. Rear Axle Shift Control Switch
- B. Heated Mirror Switch (option)
- C. Pushbutton Range Selector Digital Display
- D. Pushbutton Range Selector
- E. Ignition Switch
- F. Operator Control Switch
- G. Parking Brake Knob

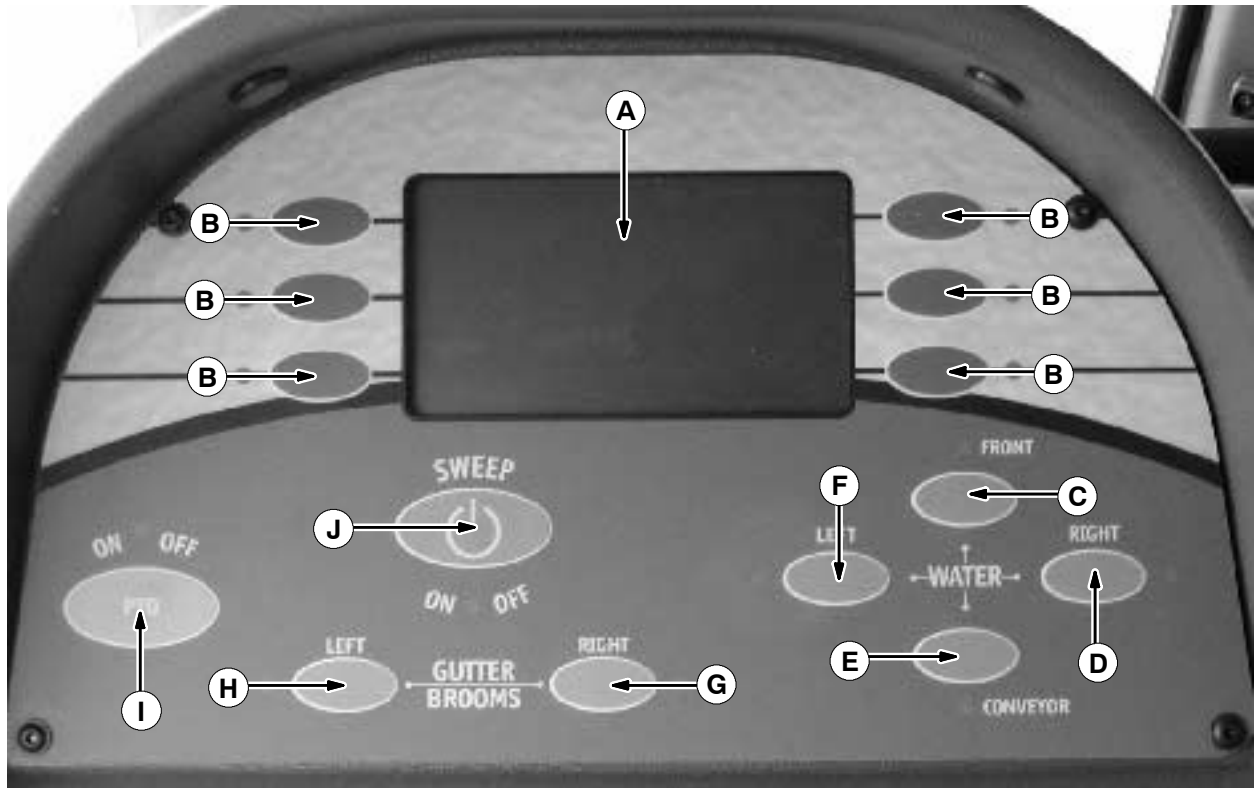

**TOUCH PANEL**

- A. Display Screen**
- B. Multi-Function Switches (6)**
- C. Front Spray Nozzle Switch**
- D. Right Side Gutter Broom Spray Nozzle Switch**
- E. Conveyor Spray Nozzle Switch**
- F. Left Side Gutter Broom Spray Nozzle Switch (Option)**
- G. Right Side Gutter Broom Switch**
- H. Left Side Gutter Broom Switch (Option)**
- I. PTO (Power Take Off) Switch**
- J. Sweep Switch**



---

**OPERATION OF CONTROLS**

---

**IGNITION SWITCH**

The *ignition switch* starts and stops the truck engine with a key. Refer to the truck manuals for proper operation.

**FOR SAFETY: Do not operate machine unless all TENNANT and truck manuals are read and understood.**

**PARKING BRAKE KNOB**

The *parking brake knob* sets and releases the machine air brakes. Refer to the truck manuals for proper operation.

**FOR SAFETY: Do not operate machine unless all TENNANT and truck manuals are read and understood.**

**OPERATOR CONTROL SWITCH**

The *operator control switch* transfers the throttle and power steering controls from one side of the operator's compartment to the other. It also turns on the side instrument console.

Activate Right Side Controls: Press the right side of the switch.

Activate Left Side Controls: Press the left side of the switch.



**WARNING: Loss Of Steering Control Can Result. Stop Machine And Place In Neutral Before Switching Operator Control.**



## OPERATION

### REAR AXLE SHIFT CONTROL SWITCH

The *rear axle shift control switch* controls the rear axle operating range. Refer to the truck manuals for proper operation.

**FOR SAFETY: Do not operate machine unless all TENNANT and truck operation manuals are read and understood.**

*NOTE: For best slow speed sweeping results, drive the machine in **D1 (first gear)** with the differential in **low** range.*

*NOTE: To engage the low range on the differential, stop the truck on level surface, place transmission in neutral and select **low** range.*



### FAST IDLE SWITCH

The *fast idle switch* controls the manual fast idle system. Refer to the truck manuals for proper operation.

**FOR SAFETY: Do not operate machine unless all TENNANT and truck operation manuals are read and understood.**

*NOTE: For best slow speed sweeping results, keep the machine in low axle range while sweeping.*



### HEATED MIRROR SWITCH (OPTION)

The *heated mirror switch* controls the heated mirror option. Refer to the truck manuals for proper operation.

**FOR SAFETY: Do not operate machine unless all TENNANT and truck operation manuals are read and understood.**



### PUSHBUTTON RANGE SELECTOR

The *pushbutton range selector* is used to select the different operating gears and D (Drive) ranges. The digital display shows what gear or operating range the truck is in. Refer to the truck manuals for proper operation.

**FOR SAFETY: Do not operate machine unless all TENNANT and truck operation manuals are read and understood.**

*NOTE: For best slow speed sweeping results, drive the machine in **D1 (first gear)** with the differential in **low** range.*

*NOTE: To engage the low range on the differential, stop the truck on level surface, place transmission in neutral and select **low** range.*



### PTO KILL SWITCH

**(For machines below serial number 00XXXX)**

The *PTO kill switch* halts all power to the power take off shafts, sweeping functions and hopper lift functions.

Halt PTO shafts: Push the *PTO kill switch* in.

Restart PTO shafts: Turn the *PTO kill switch* to the right to release the switch.

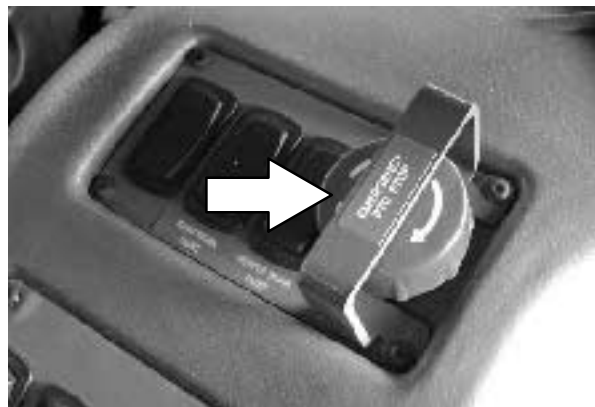

### PTO KILL SWITCH

**(For machines serial number 00XXXX and above)**

The *PTO kill switch* halts all power to the power take off shafts, sweeping functions and hopper lift functions.

Halt PTO shafts: Push the center of the *PTO kill switch* in until the switch 'clicks' and remains down in the engaged position. The touch panel will display the *release E-Stop alarm*, and the switch will illuminate while engaged.

Restart PTO shafts: Push the center of the *PTO kill switch* in until the switch 'clicks', and release the switch in the disengaged position. The light will turn off and the touch panel will return to the idle startup screen when the switch is disengaged. Press the sweep switch or PTO switch to restart the PTO shafts.



## OPERATION

### REAR WORK LIGHT SWITCH (OPTION)

The *rear work light switch* powers on and off the rear work light.

On: Press the top of the *rear work light switch*. The rear work light will come on.

Off: Press the bottom of the *rear work light switch*. The rear work light will turn off.



### HOPPER WORK LIGHT SWITCH (OPTION)

The *hopper work light switch* powers on and off the hopper work light.

On: Press the top of the *hopper work light switch*. The hopper work light will come on.

Off: Press the bottom of the *hopper work light switch*. The hopper work light will turn off.



### RIGHT SIDE INSTRUMENT CONSOLE

The *right side instrument console* is activated by the *operator control switch*, and displays the gauges for the machine operator sitting in the right side operator's compartment.



## TACHOMETER

The *tachometer* shows the engine RPM. Increase or decrease the throttle until the tachometer shows the desired engine RPM for transporting or sweeping.

*NOTE: The REDUCE ENGINE RPM ALARM will sound and appear if the engine speed is greater than 900 RPM when starting the sweeping system.*

*NOTE: The OVERSPEED, ENGINE ALARM will sound and appear if the engine speed becomes greater than 2200 RPM while sweeping.*

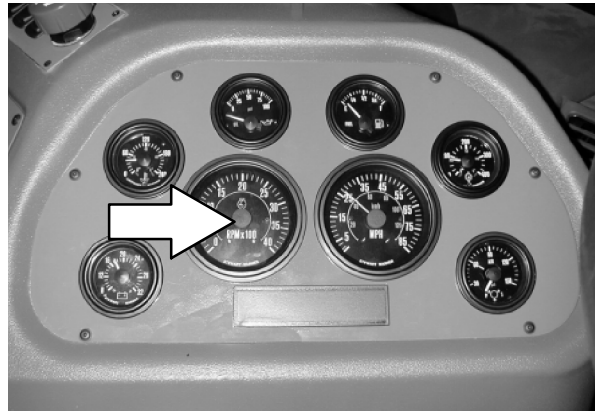

There are three engine speed displays; Idle Speed, Low Speed and Full Power. The displays are shown on the bottom of the display panel, and are used to help maintain the proper engine speeds while using the different sweeping modes.

IDLE SPEED - < 950 RPM

LOW SPEED - 950 to 1175 RPM

FULL POWER - > 1175 RPM

Refer to the SWEEP MODES section of the manual for the recommended engine speeds of each sweeping mode.

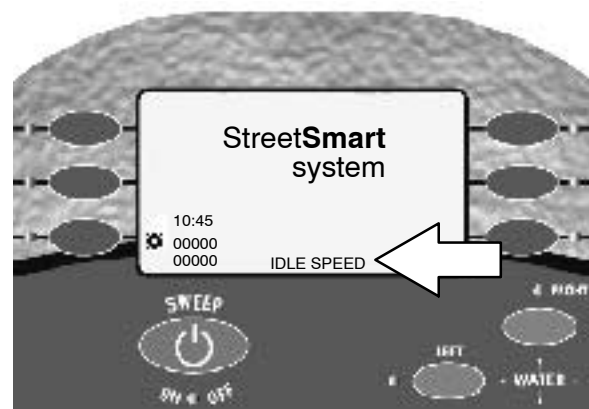

## SPEEDOMETER

The *speedometer* displays the machine's travel speed. Use this for determining the proper operating speed for sweeping and transporting.

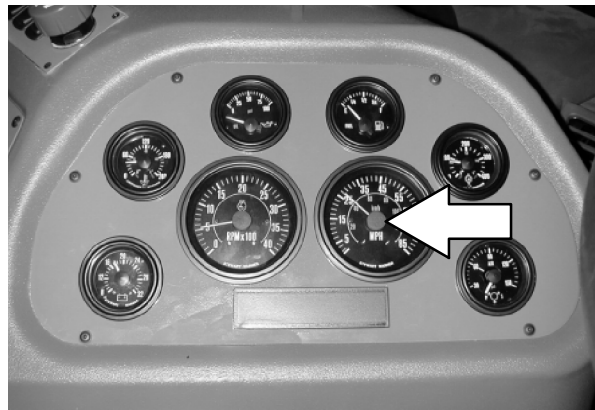

## OPERATION

### ENGINE OIL PRESSURE GAUGE

The *engine oil pressure gauge* displays the engine oil pressure. Normal engine oil pressure ranges between 240–480 kPa (35–70 psi). If the oil pressure falls too low, stop the engine, locate the problem and have it corrected. Refer to the *ENGINE OIL* section of the truck manuals for proper operation.

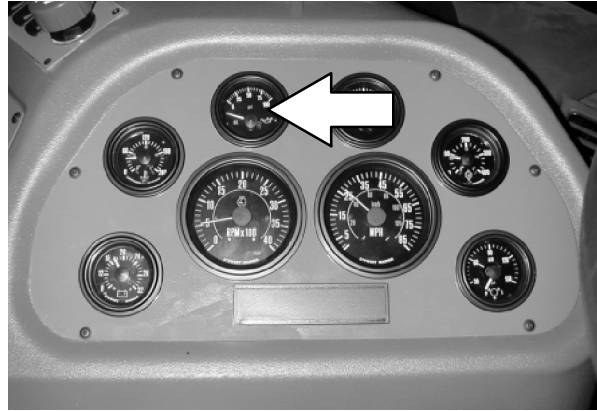

### ENGINE COOLANT TEMPERATURE GAUGE

The *engine coolant temperature gauge* shows the engine coolant temperature. Normal engine coolant temperature ranges between 88°–102°C (190°–215°F). If the engine coolant temperature is too hot, or if the engine coolant temperature gauge warning light comes on, stop the engine, locate the problem and have it corrected. Refer to the *COOLING SYSTEM* section of the truck manuals for proper operation.

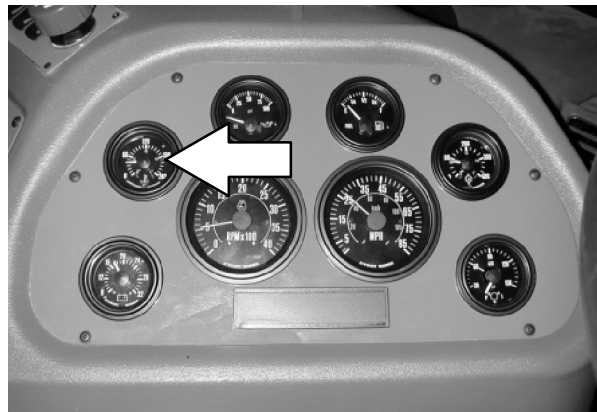

### VOLTMETER

The *voltmeter* displays the existing voltage of the battery. Normal voltage ranges between 12–14.5 volts. If the voltage falls too low, stop operating the machine, locate the problem and have it corrected.

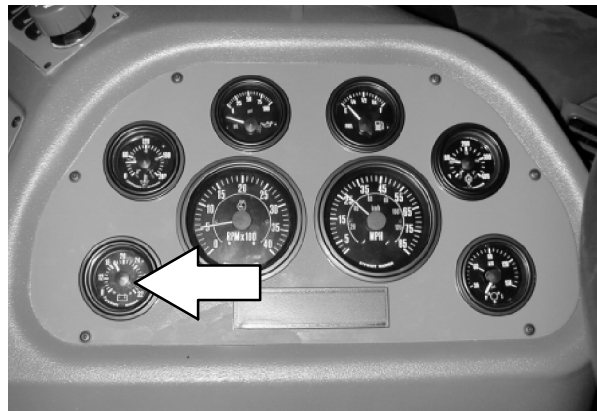

### FUEL LEVEL GAUGE

The *fuel level gauge* indicates how much fuel is in the fuel tank.

*NOTE: Do not let the fuel tank empty completely. Air can enter the fuel system and require bleeding, before the next engine start.*

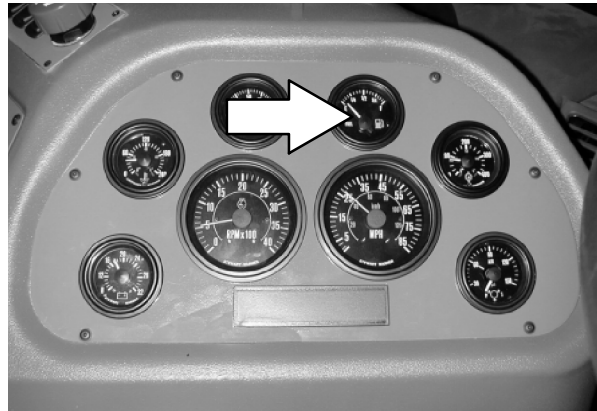

### TRANSMISSION TEMPERATURE GAUGE

The *transmission temperature gauge* shows the transmission temperature. Normal operating temperature ranges between 71°–110°C (160°–230°F). If the transmission temperature is too hot, or if the transmission temperature gauge warning light comes on, stop the machine, locate the problem and have it corrected. Refer to the *TRANSMISSION* section of the truck manuals for proper operation.

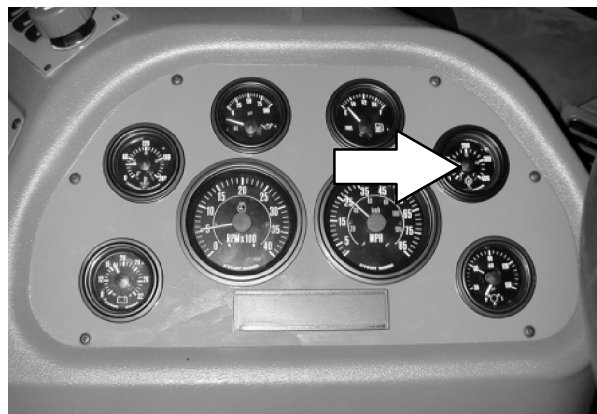

### AIR BRAKE PRESSURE GAUGE

The *air brake pressure gauge* displays the air brake reservoir pressure. The reservoir pressure should run close to 690 kPa (120 psi). If the air brake pressure drops below 413–482 kPa (60–70 psi), stop the machine, locate the problem and have it corrected. Refer to the *AIR BRAKE* section of the truck manuals for proper operation.

*NOTE: An audible alarm will sound when the machine is started, until the brake reservoir pressure reaches the minimum tank pressure required to release the parking brake; 414–482 kPa (60–70 psi).*

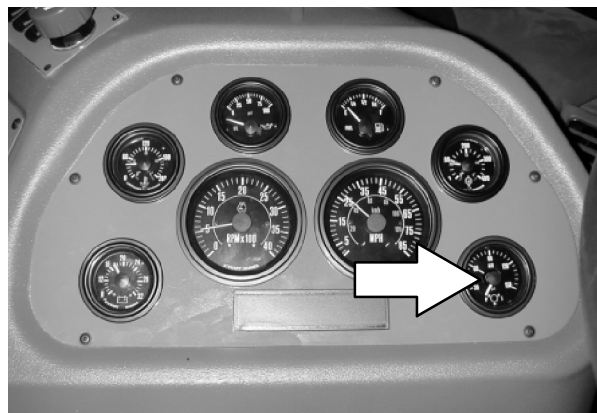

## OPERATION

### BRIGHT HEADLIGHTS LIGHT

The *bright headlights light* comes on when the headlights are on the bright setting.

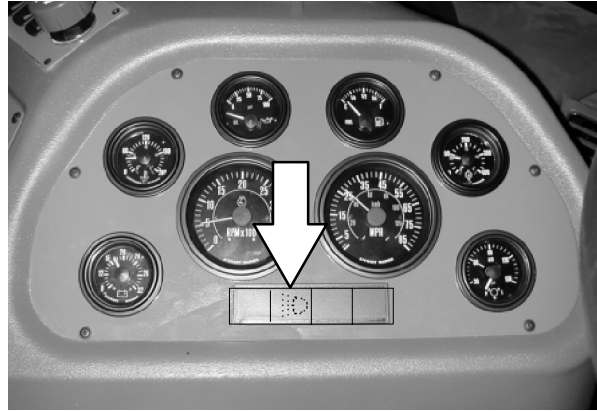

### PREHEAT LIGHT

The *preheat light* comes on when the ignition switch is turned to the ON position. The light will go out when the engine is ready to start, usually 5 to 30 seconds depending on the weather conditions.

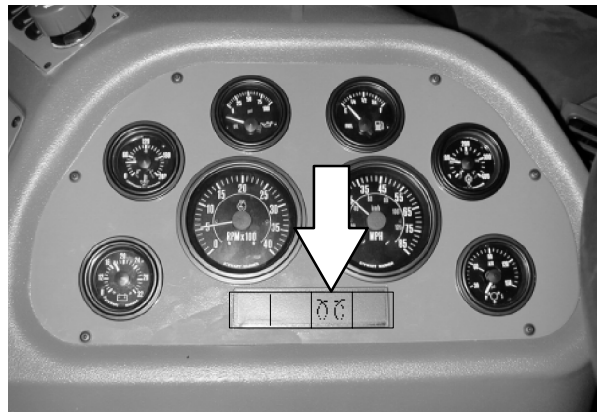

### SIGNAL LIGHT

The *signal light* arrows flash when the turn signals are used or when the 4-way warning lights are on.

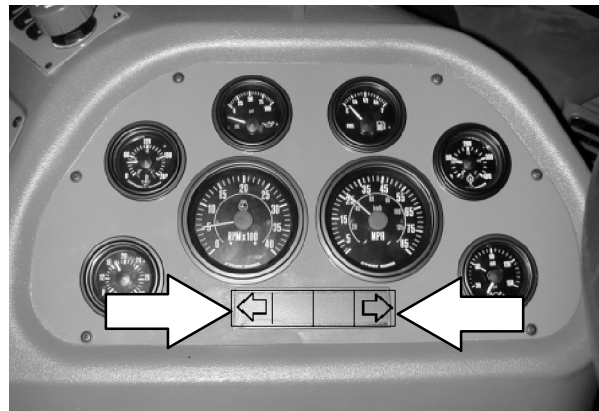



**TOUCH PANEL**

The *touch panel* contains the switches that control the PTO, hopper and sweeping functions. It is located on top of the console in the center of the cab.

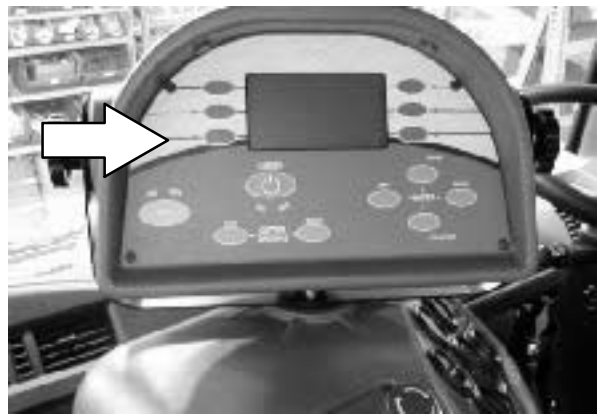

**START UP SCREEN**

The *START UP screen* appears on the display screen when the machine is started. It displays the display clock, hourmeter and the MORE switch.



**DISPLAY CLOCK**

The *display clock* appears on the START UP screen above the hourmeter, and shows the time of day.

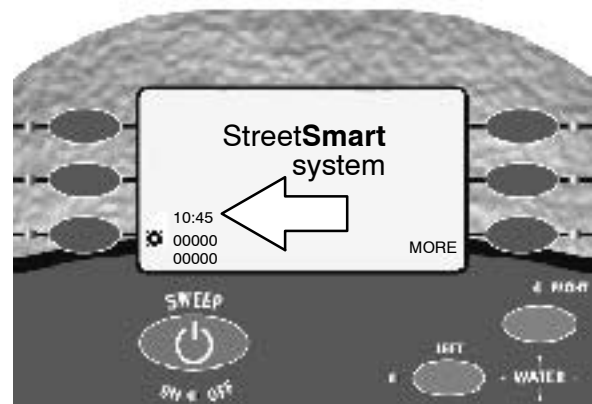

# OPERATION

## HOURLMETER

The *hourmeter* appears on the START UP screen, and records the number of hours the power take offs have been operating. Use this information to determine machine maintenance intervals.

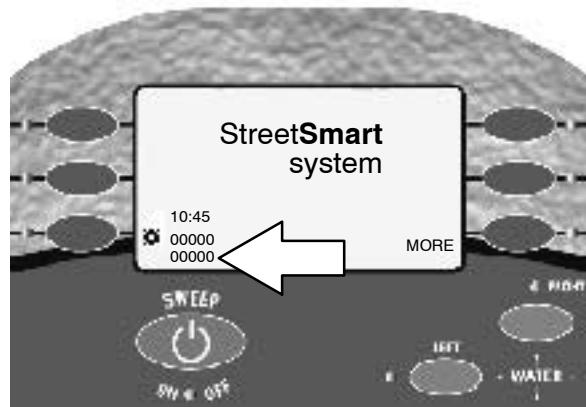

## BRUSH HOURLMETER

The *brush hourmeter* appears on the START UP screen, and records the number of hours the main brush has been operating. Use this information to determine machine maintenance intervals.

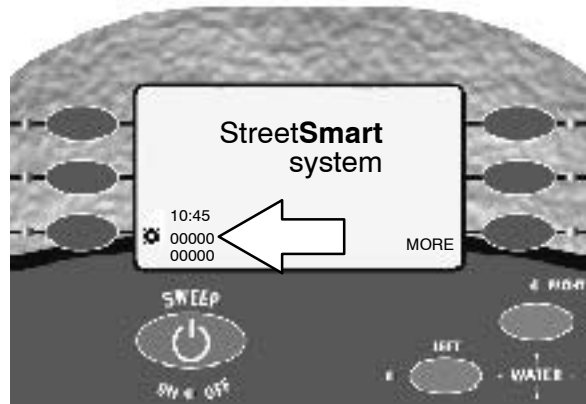

## MORE SWITCH

The *MORE switch* appears on the START UP screen and the five operating screens. Press the switch once to cycle to the next screen. The switch will continue cycling through the five screens each time it is pressed.

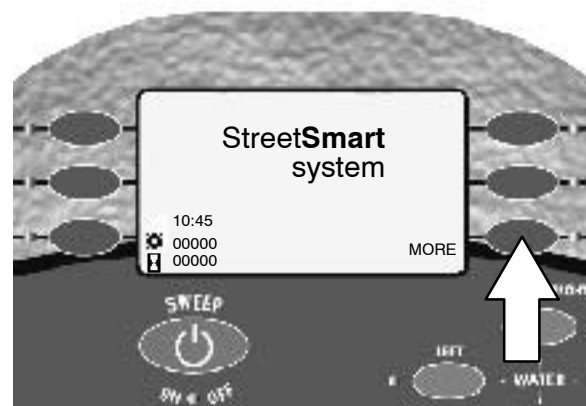

## PTO SWITCH

The *PTO switch* controls the power take off. The PTO drives the sweeping assembly and the hopper lift. When the PTO is activated, the engine speed will raise to 1000 RPM to power the PTO driven sweeping and hopper lift functions. Keep the engine RPM below 950 RPM when activating the PTO switch.

**NOTE:** The *REDUCE ENGINE RPM ALARM* will sound and appear if the engine speed is greater than 950 RPM when the PTO is engaged.

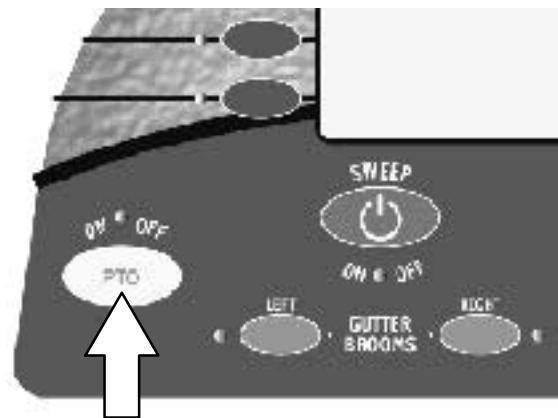

To start the PTO, press the *PTO switch*. The touch panel will display the HOPPER MODE screen and the light above the switch will come on. The PTO shafts will engage and the engine speed will raise to 1000 RPM.

**NOTE:** The *OVERSPEED, ENGINE ALARM* will sound and appear if the engine speed becomes greater than 2200 RPM while the PTO is engaged.

**NOTE:** The *PTO shafts* will automatically engage when the sweep switch or the hopper up switch is pressed.



To stop the PTO, check that the sweep switch is off, and press the *PTO switch* again. The light above the *PTO switch* will turn off.

**NOTE:** The *ERROR-BROOMS DOWN ALARM* will sound and appear if you try to turn off the PTO with the sweep switch on.

## OPERATION

### SWEEP SWITCH

The *sweep switch* controls the sweeping functions of the machine. These functions include the vacuum fan, the main broom, the conveyor and the gutter broom(s).

**NOTE:** The *HOPPER UP ERROR ALARM* will sound and appear if the sweep switch or the conveyor is activated with the hopper still in the raised position. The sweep switch can **NOT** be activated if any of the hopper control switches are lit. The hopper must be closed and fully lowered before sweeping.



To start the sweeping functions, press the *sweep switch*. The touch panel will display a SWEEPER TURNING ON message for a few seconds, and then display the SWEEP MODE screen. The PTO shafts will engage and the engine speed will raise to 1000 RPM.

The conveyor will lower and move in to the sweeping position and the vacuum fan will turn on. The lights next to these switches will come on. The gutter broom(s), vacuum fan and water pump will also automatically turn on with the *sweep switch* **IF** they were in the **on** position when the sweep switch was last turned off.



**NOTE:** The *REDUCE ENGINE RPM ALARM* will sound and appear if the engine speed is greater than 950 RPM when the PTO is engaged.

To stop and raise the sweeping functions, press the *sweep switch* again. The lights next to these sweeping function switches will turn off. The touch panel will display a SWEEPER TURNING OFF message for a few seconds, and then display the SWEEP MODE screen.

**NOTE:** The sweep mode, water flow rate, gutter broom(s), and vacuum fan will default to the last setting used when the sweeping operations are started again.

**NOTE:** For best slow speed sweeping results, drive the machine in D1 (first gear) with the differential in low range.

**NOTE:** The *HOPPER FIRE ALARM* will sound and appear and the sweep functions will automatically turn off when the Thermo Sentry™ senses a possible fire in the hopper.

**SWEEP MODE SWITCH**

The *sweep mode switch* appears on the SWEEP MODE screen and controls the sweep mode the machine is sweeping in. PRESS the *sweep mode switch* to scroll through the different sweep modes; economy/light, normal, heavy work, leaves/litter, road milling and custom.

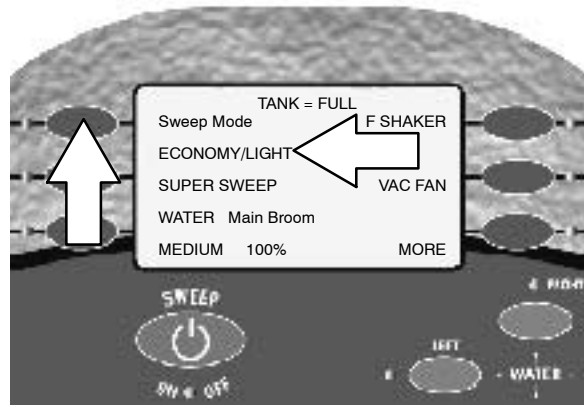

**SUPER SWEEP SWITCH**

The *super sweep switch* appears on the SWEEP MODE screen, and puts the machine in the heavy sweeping mode for 30 seconds. Press the *super sweep switch* to activate the heavy sweeping mode. The light next to the switch will come on while the machine is in the heavy sweeping mode.

The machine will return to the mode it was working in and the light next to the switch will turn off after 30 seconds.

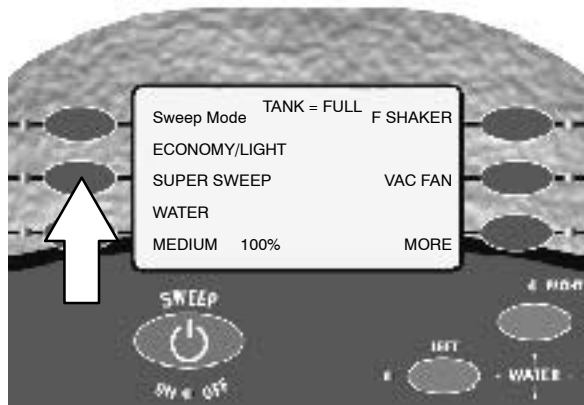

**BRUSH WEAR INDICATOR**

The *brush wear indicator* appears on the bottom of the SWEEP MODE screen, and displays the percentage of brush bristle that is left on the main sweeping brush. When the indicator displays 5% or less, the brush diameter is approximately 55-60 mm (22-24 in).

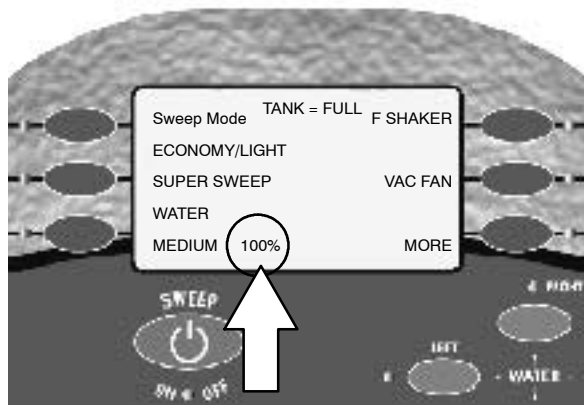

## OPERATION

### WATER FLOW SWITCH

The *water flow switch* appears on the SWEEP MODE screen and controls the amount of water flow for the wet dust control system.

Press the water flow switch to scroll through the three water flow options; LIGHT, MEDIUM and HIGH. The light next to the switch will come on when one or more of the water spray switches are on.

*NOTE: The TANK LOW, PUMP OFF ALARM will sound and appear when the water tank level is low.*

*NOTE: The water flow switch and water spray switches will automatically turn on with the SWEEP SWITCH **IF** they were in the **on** position when the sweep switch was last turned off.*

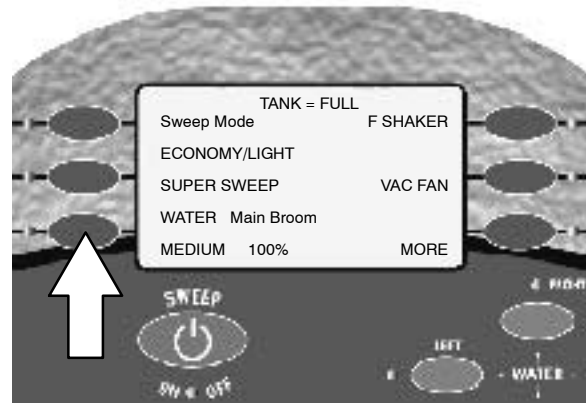

### WATER TANK LEVEL GAUGE

The *water tank level gauge* appears on the top of the SWEEP MODE screen. It displays the amount of water left in the water tank for the wet dust control system. Four water level switches in the tank let the display know when the tank is full, 3/4, 1/2, 1/4 or empty.

*NOTE: The TANK LOW, PUMP OFF ALARM will sound and appear when the water tank level is low.*

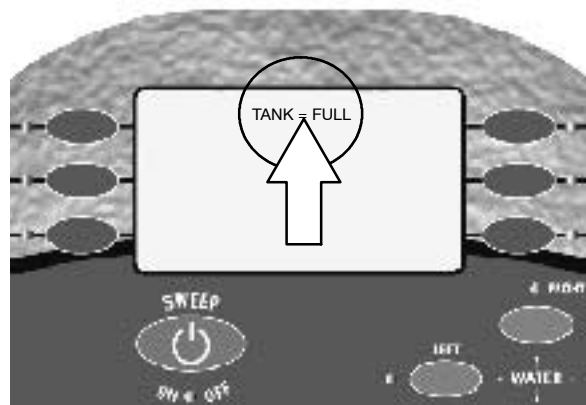

**FILTER SHAKER SWITCH**

The *filter shaker switch* appears on the SWEEP MODE screen and the HOPPER CONTROL screen. It is used to shake clean the dust from the filter. Press the switch to activate the system.

*NOTE: The SHAKE FILTER ALARM will sound and appear when the hopper filter is full of debris, unless the machine is equipped with the dry dust control (option).*



The touch panel will display a SHAKER PROCESS BEGINNING message for a few seconds, and the light next to the switch will come on. The filter will shake for about 60 seconds, then it will stop and the light next to the switch will turn off.



The touch panel will display a FILTER SHAKER PRESS TO SHAKE message for a few seconds after the sweep switch is turned off. Press the switch to activate the filter shaker.

The filter shaker may need to be operated more frequently in heavy dust conditions.

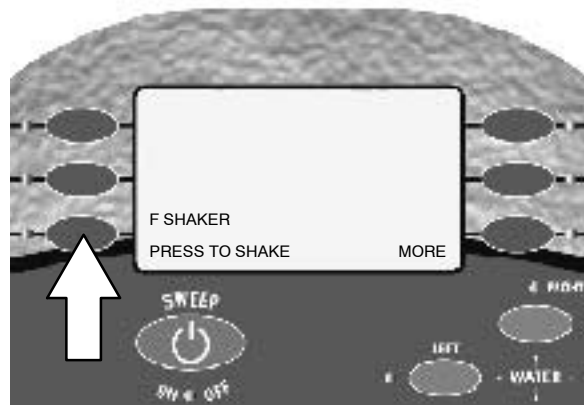

## OPERATION

### VACUUM FAN SWITCH

The *vacuum fan switch* appears on the SWEEP MODE screen, and controls the vacuum fan. This switch will come on automatically when the sweep switch is activated. It can be controlled separately without the other sweeping functions. For example, the vacuum fan can be turned off for sweeping in rainy conditions. Press the switch to turn on the vacuum fan. The light next to the switch will come on. Press the switch again to turn the vacuum fan off. The light next to the switch will turn off.

**NOTE:** The vacuum fan switch will automatically turn on with the SWEEP SWITCH **IF** it was in the **on** position when the sweep switch was last turned off.

**NOTE:** The HOPPER FIRE ALARM will sound and appear and the vacuum fan will automatically turn off when the Thermo Sentry™ senses a possible fire in the hopper.



### LEFT SIDE GUTTER BROOM SWITCH (OPTION)

The *left side gutter broom switch* controls the optional left side gutter broom. Press the switch to lower and turn on the left side gutter broom. The light next to the switch will come on. To lift and turn off the left side gutter broom, press the switch again. The light next to the switch will turn off.

**WARNING:** Side brush can move. Do not step on side brush.

**NOTE:** The gutter brooms will automatically turn on with the SWEEP SWITCH **IF** they were in the **on** position when the sweep switch was last turned off.

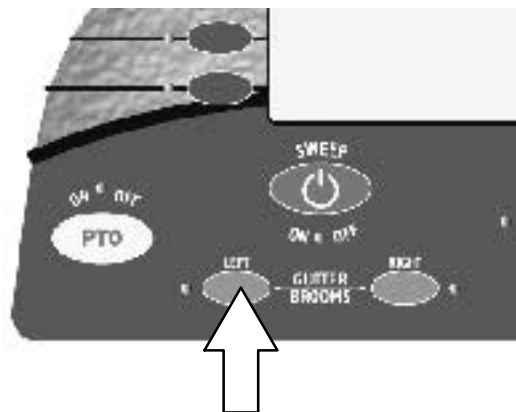

### RIGHT SIDE GUTTER BROOM SWITCH

The *right side gutter broom switch* controls the right side gutter broom. Press the switch to lower and turn on the right side gutter broom. The light next to the switch will come on. To lift and turn off the right side gutter broom, press the switch again. The light next to the switch will turn off.

**WARNING:** Side brush can move. Do not step on side brush.

**NOTE:** The gutter brooms will automatically turn on with the SWEEP SWITCH **IF** they were in the **on** position when the sweep switch was last turned off.

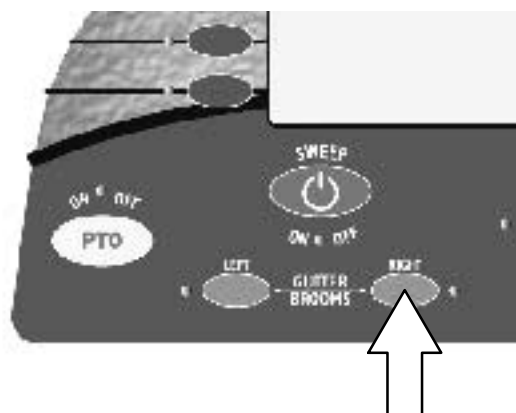



## HOPPER UP SWITCH

The *hopper up switch* appears on the HOPPER CONTROL screen. It moves the conveyor out away from the hopper and raises the hopper for high dumping. The *hopper up switch* will turn on the PTO automatically if it is not on before the switch is pressed.

**WARNING:** High dump vertical clearance. Stay clear of overhead obstructions and power lines.

**WARNING:** Lift arm pinch point. Stay clear of hopper lift arms.

**FOR SAFETY:** Do not move machine when hopper is raised.

Press and hold the switch until the conveyor moves out, away from the hopper and the hopper raises. Release the switch when the hopper is at the desired raised position. An audio alarm will sound while the hopper is moving. The hopper lift will automatically stop when it is fully raised. The light next to the switch will come on only while the switch is being pressed.

*NOTE: The ACTIVATE PARK BRAKE ALARM will sound and appear if a hopper lift or hopper dump is attempted and the parking brake is not set.*

*NOTE: The MACHINE NOT LEVEL ALARM will sound and appear if a hopper lift or high dump is attempted and the machine is on an incline that is unsafe for high dumping the hopper.*

*NOTE: The CONVEYOR NOT BACK ALARM will sound and appear if a hopper lift is attempted and the conveyor is not all the way back.*

## HOPPER DOWN SWITCH

The *hopper down switch* appears on the HOPPER CONTROL screen and lowers the hopper after high dumping.

**WARNING:** Lift arm pinch point. Stay clear of hopper lift arms.

Press and hold the switch until the hopper is fully lowered. The light next to the switch will come on only while the switch is being pressed. The light will turn off when the switch is released.

*NOTE: The CONVEYOR NOT BACK ALARM will sound and appear if a hopper lower is attempted and the conveyor is not all the way back.*

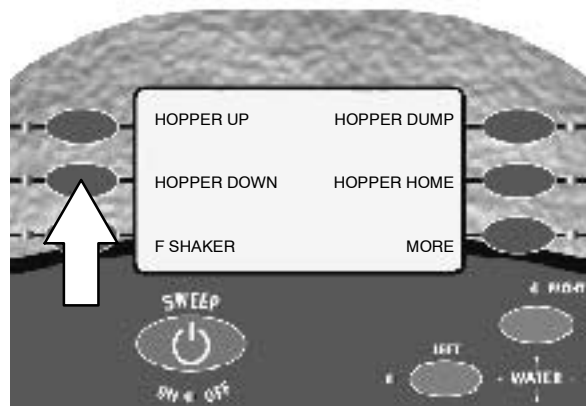
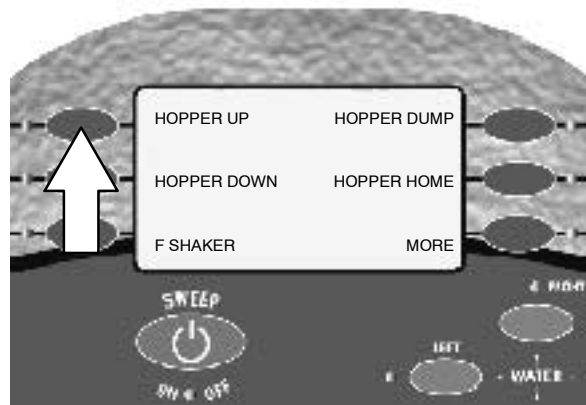

## OPERATION

### HOPPER DUMP SWITCH

The *hopper dump switch* appears on the HOPPER CONTROL screen. It opens the hopper door and tilts the hopper for dumping debris.

**WARNING:** High dump vertical clearance. Stay clear of overhead obstructions and power lines.

**WARNING:** Lift arm pinch point. Stay clear of hopper lift arms.

**FOR SAFETY:** Do not move machine when hopper is raised.

Press and hold the hopper dump switch until the hopper door is open and the hopper is in the desired tilted position, then release the switch. The hopper will automatically stop when it is fully titled. The light next to the switch will come on only while the switch is being pressed.

*NOTE: The ACTIVATE PARK BRAKE ALARM will sound and appear if a hopper dump is attempted and the parking brake is not set.*

*NOTE: The MACHINE NOT LEVEL ALARM will sound and appear if a hopper lift or high dump is attempted and the machine is on an incline that is unsafe for high dumping the hopper.*

*NOTE: The CONVEYOR NOT BACK ALARM will sound and appear if a hopper dump is attempted and the conveyor is not all the way back.*



### HOPPER HOME SWITCH

The *hopper home switch* appears on the HOPPER CONTROL screen. It tilts the hopper back to the level position and closes the hopper door after dumping debris. Press and hold the switch until the hopper is fully back in the level position and the hopper door is closed. The light next to the switch will come on only while the switch is being pressed.

**WARNING:** Lift arm pinch point. Stay clear of hopper lift arms.

*NOTE: The CONVEYOR NOT BACK ALARM will sound and appear if the hopper home switch is pressed and the conveyor is not all the way back.*



### CONVEYOR IN SWITCH

The *conveyor in switch* appears on the CONVEYOR CONTROL screen and controls the position of the debris conveyor. Press and hold the switch to move the conveyor in to the debris hopper. The light next to the switch will come on and stay on while the conveyor is in. Press the switch again and the light next to the switch will turn off.

**WARNING: Conveyor throws debris. Conveyor pinch point. Stay clear when in operation.**

*NOTE: The HOPPER UP ERROR ALARM will sound and appear if a conveyor move is attempted and the hopper is not in the lowered position.*

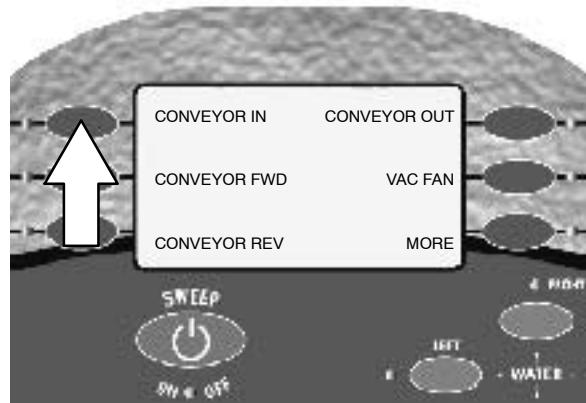

### CONVEYOR FORWARD SWITCH

The *conveyor forward switch* appears on the CONVEYOR CONTROL screen and controls the direction of the debris conveyor. This switch is primarily used to clean the conveyor and check the tracking of the conveyor when not sweeping. Press the switch to rotate the conveyor in the forward position. The light next to the switch will come on. Press the switch again to stop the conveyor. The light next to the switch will turn off.

**WARNING: Conveyor throws debris. Conveyor pinch point. Stay clear when in operation.**

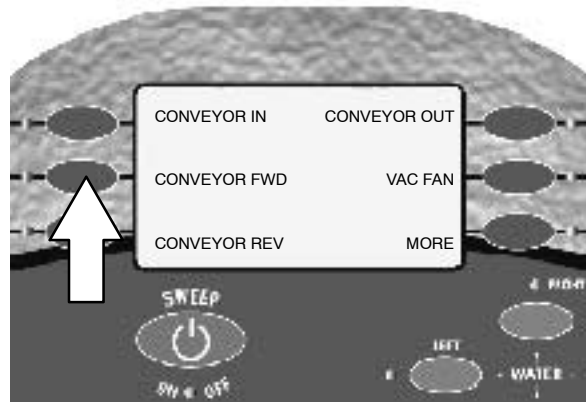

### CONVEYOR REVERSE SWITCH

The conveyor reverse switch appears on the CONVEYOR CONTROL screen and reverses the direction of the debris conveyor to help remove any debris that may become jammed in the conveyor. Press and hold the switch to reverse the direction of the conveyor. The light next to the switch will come on while the switch is pressed. Release the switch and the conveyor will return to the off position. The light next to the switch will turn off.

**WARNING: Conveyor throws debris. Conveyor pinch point. Stay clear when in operation.**

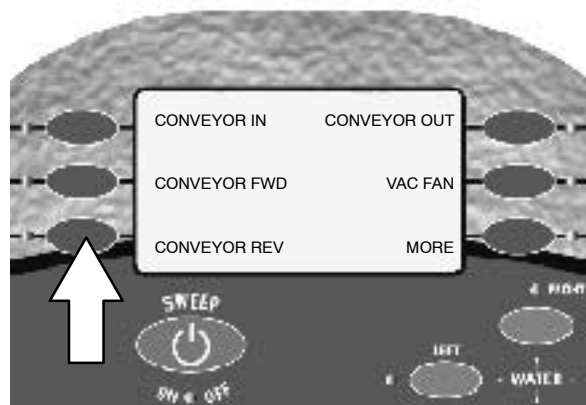

*NOTE: Do not operate the conveyor in reverse for more than 15 seconds at a time. The belt can become misaligned and damage to the machine can occur.*

## OPERATION

### CONVEYOR OUT SWITCH

The *conveyor out switch* appears on the CONVEYOR CONTROL screen and controls the position of the debris conveyor. Press and hold the switch to move the conveyor back away from the debris hopper. The light next to the switch will come on while the switch is pressed. Press the switch again to turn the light next to the switch off.



**WARNING: Conveyor throws debris. Conveyor pinch point. Stay clear when in operation.**



### CONVEYOR WATER SPRAY SWITCH

The *conveyor water spray switch* controls the water spray nozzles along the bottom and the top of the conveyor for the wet dust control system. Press the switch to start the water pump and begin spraying. The light below the switch will come on. Press the switch again to turn the water spray off. The light below the switch will turn off.

*NOTE: The water spray switches will automatically turn on with the SWEEP SWITCH **IF** they were in the **on** position when the sweep switch was last turned off.*

*NOTE: The TANK LOW, PUMP OFF ALARM will sound and appear when the water tank level is low.*

*NOTE: The HOPPER FIRE ALARM will sound and appear and the conveyor water spray will automatically turn on when the Thermo Sentry™ senses a possible fire in the hopper.*

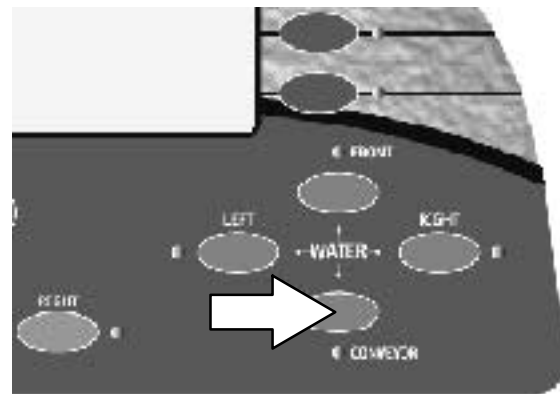

### FRONT WATER SPRAY SWITCH

The *front water spray switch* controls the water spray nozzles under the front of the machine for the wet dust control system. Press the switch to start the water pump and begin spraying. The light above the switch will come on. Press the switch again to turn the front water spray off. The light above the switch will turn off.

*NOTE: The water spray switches will automatically turn on with the SWEEP SWITCH **IF** they were in the **on** position when the sweep switch was last turned off.*

*NOTE: The TANK LOW, PUMP OFF ALARM will sound and appear when the water tank level is low.*

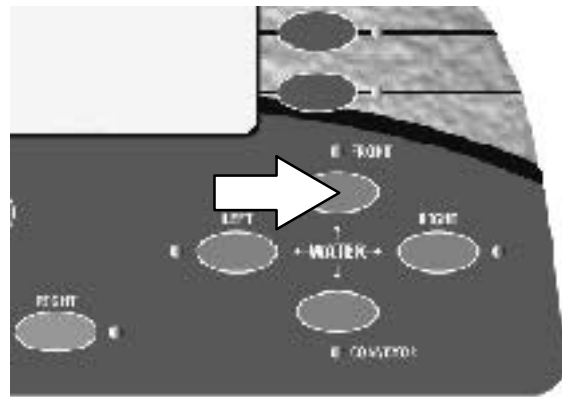

### LEFT SIDE WATER SPRAY SWITCH

The *left side water spray switch* controls the water spray nozzles in front of the optional left side gutter broom for the wet dust control system. Press the switch to start the water pump and begin spraying. The light next to the switch will come on. Press the switch again to turn the water spray off. The light next to the switch will turn off.

*NOTE: The water spray switches will automatically turn on with the SWEEP SWITCH **IF** they were in the **on** position when the sweep switch was last turned off.*

*NOTE: The TANK LOW, PUMP OFF ALARM will sound and appear when the water tank level is low.*

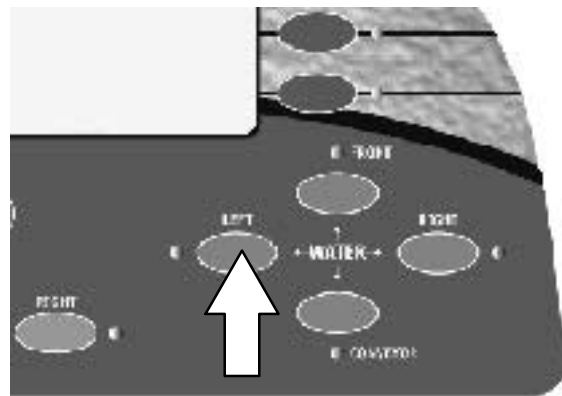

### RIGHT SIDE WATER SPRAY SWITCH

The *right side water spray switch* controls the water spray nozzles in front of the right side gutter broom for the wet dust control system. Press the switch to start the water pump and begin spraying. The light next to the switch will turn on. Press the switch again to turn the water spray off. The light next to the switch will turn off.

*NOTE: The water spray switches will automatically turn on with the SWEEP SWITCH **IF** they were in the **on** position when the sweep switch was last turned off.*

*NOTE: The TANK LOW, PUMP OFF ALARM will sound and appear when the water tank level is low.*

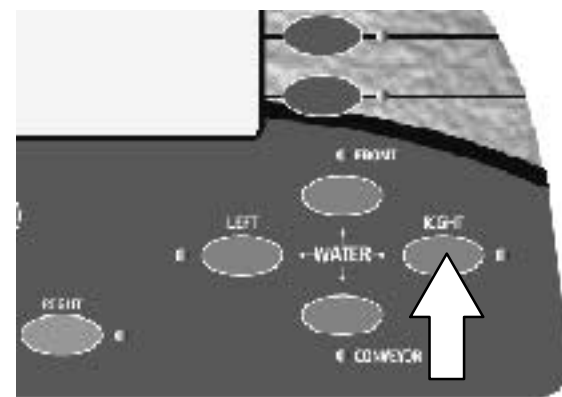

# OPERATION

## FUSES

(For Machines below serial number 001040)

Fuses are a one-time protection device designed to stop the flow of current in the event of a circuit overload. This machine uses automotive ATO type fuses. **Never substitute higher value fuses than specified.**

The fuses are located in the fuse box under the fuse plate of the center console and in the battery box outside relay enclosure.



Fuse	Rating	Circuit Protected
F1	20 A	Control Board/Cab Outside alarms
F1-2	20 A	Main brush
F1-3	20 A	Gutter broom/skirt up
F1-4	20 A	Gutter broom/skirt enable
F1-5	20 A	Main brush/drag shoe
F1-6		Open
F2-1	20 A	Conveyor control
F2-2	20 A	Conveyor direction
F2-3	20 A	Water pump/valves
F2-4	20 A	Filter shaker/ hopper control
F2-5	20 A	PTO kill switch
F2-6		Open
F3-1	30 A	Work lights
F3-2	20 A	Auxiliary relay coil
F3-3		Gutter broom tilt (option)
F3-4		Open
F3-5		Open
F3-6		Open
F3 7		Open
F3-8		Open

Fuse type	Rating	Circuit Protected
Maxi	50 A	Hydraulic fan
Maxi	60 A	Main
ATO	30 A	Auxiliary

**FUSES**

**(For Machines serial number 001040 and above)**

Fuses are a one-time protection device designed to stop the flow of current in the event of a circuit overload. This machine uses automotive ATO type fuses. **Never substitute higher value fuses than specified.**

The fuses are located in the fuse box under the fuse plate of the center console and in the battery box outside relay enclosure.

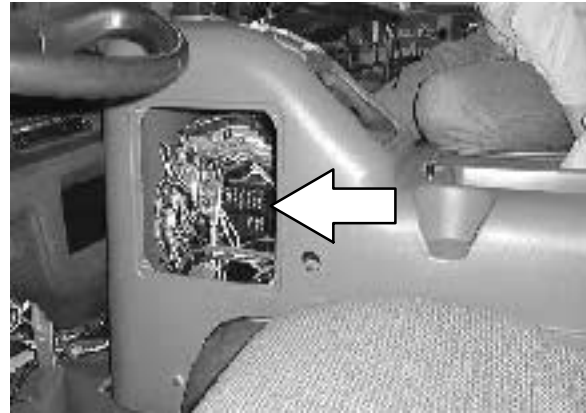

Fuse	Rating	Circuit Protected
F1	20 A	Control Board/Cab Outside alarms
F2	20 A	SV13, 28, 29, 36
F3	20 A	SV15, 16, 31A, 31B Thermo switch
F4	20 A	SV5, 9, 11, 12, 35, 38, 39 Gutter broom
F5	20 A	SV14, 17, 27, 43
F6	20 A	SV19A, 19B, 20A, 20B Conveyor
F7	20 A	SV1, 2, 3, 4, 8 Conveyor speed
F8	20 A	SV40, 41, 42, 43 Water pump
F9	20 A	SV6, 7, 23, 25, 34A, 34B SV37, Hopper full sensor
F10	20 A	PTO E-Stop, Indicator
F11	30 A	Switches (Curb & Hopper work lights)
F12	20 A	Switches (Aux. & Strobe work lights)
F13	20 A	Switches (L&R Side broom tilt option)
F14-F16	Open	Options (Switched)
F17-F20	Open	Options (Unswitched)

Fuse ID	Rating	Circuit Protected
Main	60 A	Main relay feed
Hyd oil fan	50 A	Hyd cooler fan relay feed
Auxiliary	30 A	M12 relay feed

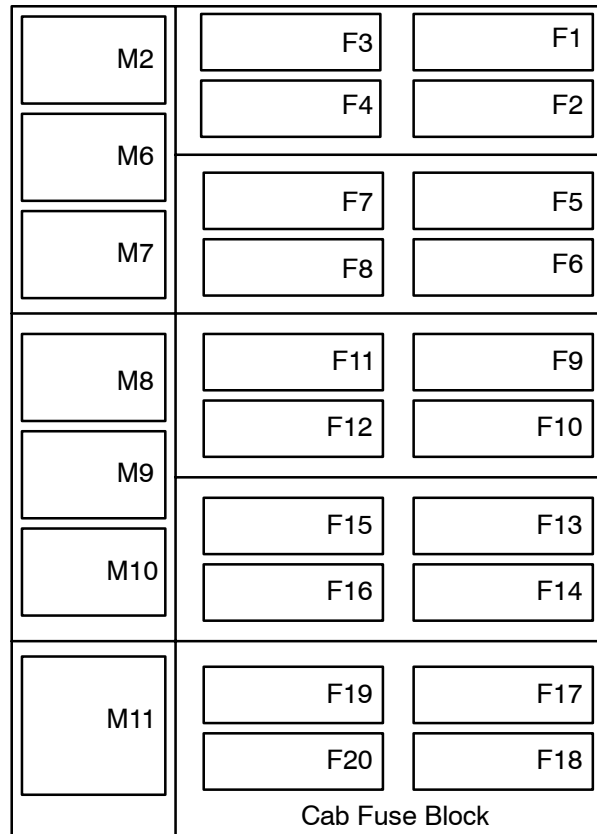

## OPERATION

### LEFT SIDE GUTTER BROOM TILT SWITCH (OPTION)

The *left side gutter broom tilt switch* activates the optional gutter broom tilt.

On: Press the top of the *left side gutter broom tilt switch* to increase the tilt angle.

Off: Press the bottom of the *left side gutter broom tilt switch* to reduce the tilt angle.



### RIGHT SIDE GUTTER BROOM TILT SWITCH (OPTION)

The *right side gutter broom tilt switch* activates the optional gutter broom tilt.

On: Press the top of the *right side gutter broom tilt switch* to increase the tilt angle.

Off: Press the bottom of the *right side gutter broom tilt switch* to reduce the tilt angle.



### GUTTER BROOM SPEED/PRESSURE ADJUSTMENT (OPTION)

Machines equipped with the *gutter broom speed/pressure adjustment* can be adjusted with the gutter broom adjustment screen.

Scroll to the gutter broom adjustment screen with the *MORE SWITCH* and adjust the side brush speed and side broom pressure with the touch panel.

Level 9 = MAX

Level 1 = MIN

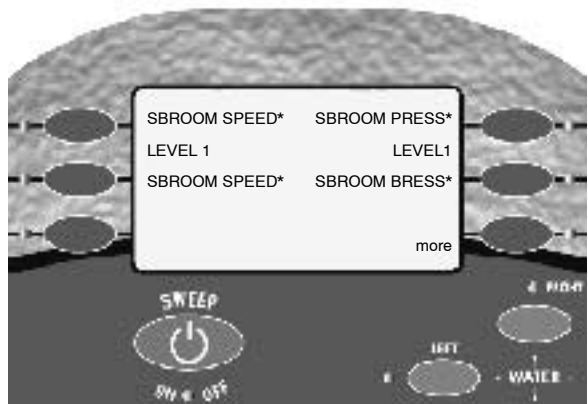



**REVOLVING LIGHT SWITCH (OPTION)**

The *revolving light switch* powers on and off the optional revolving light.

**On:** Press the top of the *revolving light switch*. The revolving light on top of the cab and the icon on top of the *revolving light switch* will come on.

**Off:** Press the bottom of the *revolving light switch*. The revolving light on top of the cab and the icon on top of the revolving light switch will turn off.

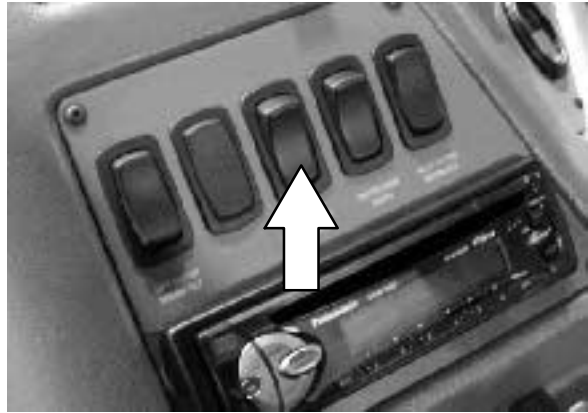
**GUTTER BROOM LIGHT SWITCH (OPTION)**

The *gutter broom light switch* powers on and off the optional gutter broom light(s).

**On:** Press the top of the gutter broom light switch. The light(s) and the icon on top of the switch will come on.

**Off:** Press the bottom of the gutter broom light switch. The light(s) and the icon on top of the switch will turn off.

**LATCHES**

The side doors and hopper access doors are secured with latches.

**Open the Side Doors:** Pull out on the latch handle.

**Open the Hopper Access Door:** Pull out on the latch handle.

The rear access door is secured with a latch.

**Open the Rear Access Door:** Lift up and twist the latch handle counter clockwise.



## OPERATION

### HOPPER TILT SUPPORT BAR

The *hopper tilt support bar* holds the hopper in the tilt position to allow work under the hopper. DO NOT rely on the machine hydraulic system to keep the hopper raised. See *ENGAGING HOPPER TILT SUPPORT BAR* section of this manual.

 **WARNING: Raised hopper may fall.**  
**Engage hopper support bar.**

The hopper tilt support bar is stored in the rear of the machine, next to the hopper lift cylinders.



### HOPPER LIFT SUPPORT BARS

The *hopper lift support bars* hold the hopper lift in the raised position to allow work under the hopper lift. DO NOT rely on the machine hydraulic system to keep the hopper lift in the raised position. See *ENGAGING HOPPER LIFT SUPPORT BARS* section of this manual.

 **WARNING: Raised hopper may fall.**  
**Engage hopper support bar.**

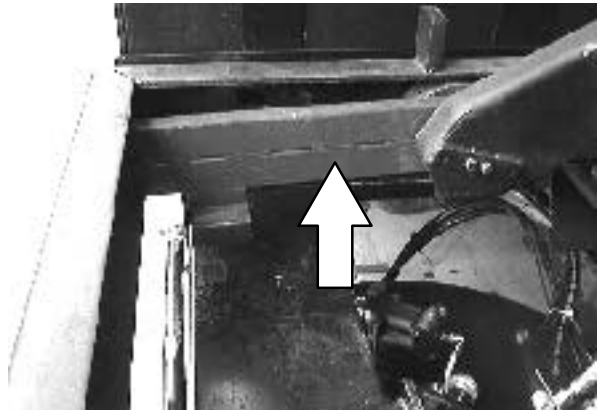

## ALARMS

### HOPPER UP ERROR ALARM

The *hopper up error alarm* comes on when the sweeping system or the conveyor is activated with the hopper still in the raised position. An audible alarm will sound once and the text message will appear on the display screen.

Check that the hopper is lowered all the way down.



### CONVEYOR NOT BACK ALARM

The *conveyor not back alarm* comes on when either the hopper up switch or the hopper down switch is pressed, and the conveyor is not all the way in the back position. An audible alarm will sound once and the text message will appear on the display screen.

Check that the conveyor is moved all the way back.



### CONVEYOR STALL ALARM

The *conveyor stall alarm* comes on when the conveyor is stalled. This can happen when an object is jammed in the conveyor. An audible alarm will sound once and the text message will appear on the display screen. The conveyor will turn off when the alarm comes on.

Press and hold the conveyor reverse switch for 10–15 seconds to help clear any debris that may be jammed in the conveyor.

**NOTE:** Do not operate the conveyor in reverse for more than 15 seconds at a time. The belt can become misaligned and damage to the machine can occur.

See *CONVEYOR BELT* in the *MAINTENANCE* section of this manual to adjust the conveyor belt.



## OPERATION

### HOPPER FIRE ALARM

The *hopper fire alarm* comes on when the Thermal Sentry™ senses a temperature of 71° C (160° F) or greater in the hopper, indicating a possible fire. An audible alarm will sound once and the text message will appear on the display screen. The Thermo Sentry™ will stop all sweeping functions. The vacuum fan will turn off and the conveyor water spray will turn on to help extinguish any hopper fire. The Thermo Sentry™ is located on the top of the hopper next to the vacuum fan housing.

The thermal sentry will reset automatically when the temperature inside the hopper drops below 60° C (140° F).



### TANK LOW, PUMP OFF ALARM

The *tank low, pump off alarm* comes on when the water tank level is low. An audible alarm will sound once and the text message will appear on the display screen. The water pump will shut off soon after this alarm comes on.

Fill the water tank when the alarm comes on.

**⚠ WARNING: Flammable materials can cause explosion or fire. Do not use flammable materials in tank. Only use water.**



### REDUCE ENGINE RPM ALARM

The *reduce engine RPM alarm* comes on when the PTO is engaged and the engine speed is greater than 950 RPM. An audible alarm will sound once and the text message will appear on the display screen.

The engine speed must be below 950 RPM before you can engage the PTO.

*NOTE: Machines serial number 0000XX and above read HIGH RPM-PTO DIS (disengage).*

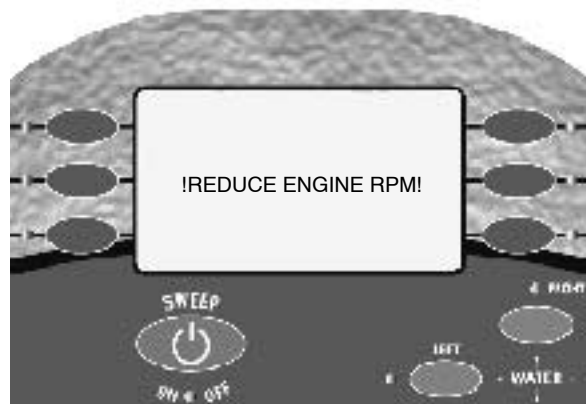

### CHECK HYDRAULIC FILTER ALARM

The *check hydraulic filter alarm* comes on when the hydraulic filter is clogged and the hydraulic filter bypass switch is activated. An audible alarm will sound once and the text message will appear on the display screen.

To replace the filter, see *HYDRAULIC FILTER* in the *MAINTENANCE* section of this manual.



### WORN MAIN BRUSH ALARM

The *worn main brush alarm* comes on when the main brush size is less than 460 mm (18 in) in diameter. An audible alarm will sound once and the text message will appear on the display screen.

To replace the main brush, see *MAIN BRUSH* in the *MAINTENANCE* section of this manual.



### ACTIVATE PARK BRAKE ALARM

The *activate park brake alarm* comes on when the hopper lift or hopper dump is activated without the parking brake set. An audible alarm will sound once and the text message will appear on the display screen.

Set the machine parking brake before raising or dumping the hopper.



## OPERATION

### SHAKE FILTER ALARM

The *shake filter alarm* comes on when the hopper filter is clogged. An audible alarm will sound once and the text message will appear on the display screen.

Press the filter shaker switch to shake the hopper filter.



### OVERSPEED ENGINE ALARM

The *overspeed engine alarm* comes on when the engine RPM is greater than 2200 RPM while the machine is sweeping. An audible alarm will sound once and the text message will appear on the display screen. The sweeping functions will shut off soon after this alarm comes on.

Keep the engine RPM below 2200 RPM while sweeping.

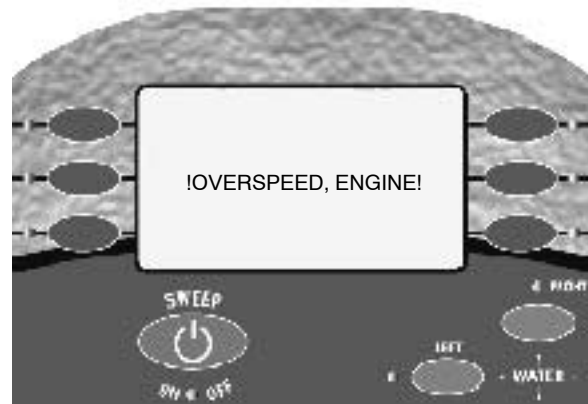

### OVERSPEED TRAVEL ALARM

The *overspeed travel alarm* comes on when the machine travel speed is greater than 24 kPh (15 MPH) while the machine is sweeping. An audible alarm will sound once and the text message will appear on the display screen. The sweeping functions will shut off soon after this alarm comes on.

Keep the machine travel speed below 24 kPh (15 MPH) while sweeping.



### MACHINE NOT LEVEL ALARM

The *machine not level alarm* comes on when a hopper lift or a hopper dump is attempted while the machine is on an incline that is unsafe for high dumping. An audible alarm will sound once and the text message will appear on the display screen.

Move the machine to a level surface and set the parking brake before raising the hopper.



### HYDRAULIC FLUID LOW ALARM

The *hydraulic fluid low alarm* comes on when the hydraulic fluid level drops below the switch in the hydraulic tank. An audible alarm will sound once and the text message will appear on the display screen. The PTO and any PTO driven functions will shut off soon after this alarm comes on.

Check that the hydraulic fluid level is at recommended operating fluid level.

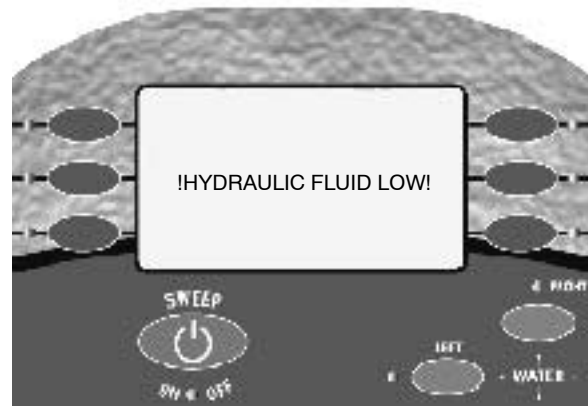

## HOW THE MACHINE WORKS

---

The steering wheel controls the direction of machine travel. The pushbutton range selector and the propelling pedal control machine speed. The brake pedal slows and stops the machine.

The gutter broom(s) sweep debris into the path of the main brush. The main brush sweeps debris from the surface onto the conveyor, which transfers the debris into the hopper. The vacuum system pulls dust and air through the hopper and the hopper dust filter.

The machine has a standard wet dust control system with a water reservoir, pump and four sets of spray nozzles. There is also an optional dry dust control system.

When sweeping is finished, clean the hopper dust filter and empty the hopper. Check and clean the conveyor daily after operating the machine.

**FOR SAFETY: Do not operate machine unless all TENNANT and truck manuals are read and understood.**



---

## PRE-OPERATION CHECKLIST

---

- Check under the machine for leaks (fuel, oil, coolant).
- Check the engine air filter on the right hand side of the machine.
- Check the engine oil level.
- Check fuel level.
- Check the hydraulic fluid level.
- Check the brakes and steering for proper operation.
- Check fuel filter water trap for water.
- Check the engine coolant level in the overflow reservoir.
- Check the radiator core exterior and hydraulic cooler fins for debris.
- Check the windshield washer fluid level.
- Check the wet dust control water reservoir level.



## STARTING THE MACHINE

1. Sit in the operator's seat and fasten the seat belt. Place your foot on the brake pedal.

**FOR SAFETY: Do not operate machine unless all TENNANT and truck manuals are read and understood.**

2. Turn the key to the ON position. Wait until the preheat indicator light turns off before attempting to start engine.



3. Check the pushbutton range selector to make sure it is in the middle N (Neutral) position.



4. Turn the key clockwise to the START position to crank the engine. Release the key after the engine starts.

**NOTE:** Do not operate the starter motor for more than 15 seconds at a time or after the engine has started. Allow the starter to cool between starting attempts or damage to the starter motor may occur.



## OPERATION

5. Allow the engine and hydraulic system to warm up 10 to 20 minutes. (Allow more time for the machine to warm up in colder temperatures). After the engine has warmed up, check that the engine idle speed has returned to normal.

**WARNING:** Engine emits toxic gases. Severe respiratory damage or asphyxiation can result. Provide adequate ventilation. Consult with your regulatory agency for exposure limits. Keep engine properly tuned.



6. Check that the brake air pressure is at normal operating range, close to 690 kPa (120 psi), and that the primary brake light and audio alarms have turned off.

7. Press your foot on the brake pedal, and release the parking brake.



8. Shift the truck from N (Neutral) to D (Drive) and select the operating gear.

9. Release the brake pedal and press on the throttle pedal to transport the machine. The more foot pressure, the faster the machine will travel.

10. Drive the machine to the area to be swept.

**FOR SAFETY:** When using machine, always follow safety and traffic rules.

**FOR SAFETY:** Do not operate machine unless all TENNANT and truck manuals are read and understood.



---

## SWEEPING AND BRUSH INFORMATION

---

The model CENTURION™ has a GVWR of 14,850 kg (33,000 lb), 4536 kg (12,000 lb) front axle and 9450 kg (21,000 lb) rear axle. Operate only on surfaces capable of supporting this weight.

Avoid bulky debris such as crates, boxes, tree branches, and very heavy material. Avoid pieces of straps, twine, rope, etc., which could become entangled in brush, brush plugs or the conveyor.

Plan the sweeping route in advance. Try to arrange long runs with minimum stopping and starting. Sweep as straight a path as possible. Overlap the brush paths.

For best low speed sweeping results, operate the machine in 1D (first gear) with the rear axle in low range. For sweeping at higher speeds use a higher gear or high axle range. Recommended maximum sweeping speed is 24 KPH (15 MPH). Recommended maximum engine speed while sweeping, is below 2000 RPM.

Use the wet dust control and optional dry dust control (if equipped) in dry or dusty conditions. Do not use the wet dust control when sweeping in wet conditions. Heavy snow and or/moisture may cause compacted debris to stick in the hopper. Turn off the vacuum fan when sweeping wet debris in rain, standing water and snow. Check the hopper for any remaining debris after dumping.



## OPERATION

**Polypropylene Main Brush** - A general purpose brush used for all sweeping applications.

The following are recommendations for the gutter broom(s). For best results, use the correct brush type for your sweeping application.

**Polypropylene and Wire Gutter Broom** - Recommended for general purpose sweeping. Best combination of sweeping and aggressiveness.

**Flat Wire Gutter Broom** - Recommended for outside and curb-side sweeping where soilage is heavy or compacted. The stiff wire bristles dig out soilage. This brush does not sweep as good as the *Polypropylene and Wire Gutter Broom* but is recommended for foundries, and applications where heat may melt synthetic bristles.



**Polypropylene Gutter Broom** - Recommended for sweeping where you cannot have wire fragments. This brush does not sweep as well as the *Polypropylene and Wire Gutter Broom* but is recommended for areas such as airports.

### SWEEP MODES

The sweep mode switch allows the operator to scroll through the different sweep modes and select another mode while sweeping. Use the recommended sweep mode and RPM for the following applications.

**Economy/Light** - Recommended mode for sweeping light debris. Recommended RPM while sweeping is >1175 RPM (FULL POWER).

**Med/Normal** - Recommended mode for standard street sweeping. Recommended RPM while sweeping is >1175 RPM (FULL POWER).

**Heavy** - Recommended for sweeping heavy debris like sand and gravel. Recommended RPM while sweeping is >1175 RPM (FULL POWER).

**Leaf** - Recommended mode for picking up larger quantities of lighter weight materials. Recommended RPM while sweeping is >1175 RPM (FULL POWER).

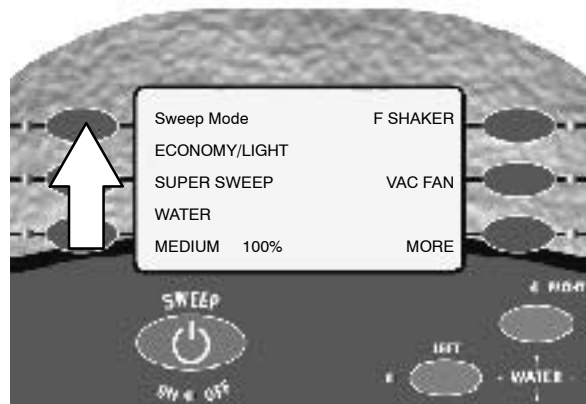

**Milling** – Recommended mode for sweeping up road millings or chip seal. The vacuum fan is off in this mode. Recommended RPM while sweeping is >950 RPM ( LOW SPEED or FULL POWER).

**Custom** – Sweeping mode that defaults to the main brush, gutter brooms and conveyor settings preset by the operator. See the SETTING THE CUSTOM MODE section of the manual. Recommended RPM while sweeping is >1175 RPM (FULL POWER).

Recommended Engine Speeds For Sweep Modes			
Sweep Mode	Idle Speed < 950 RPM	Low Speed 950-1175 RPM	Full Power > 1175 RPM
Economy/Light	Reduced	Reduced	Full
Med/Normal	Reduced	Reduced	Full
Heavy	Reduced	Reduced	Full
Leaf	Reduced	Reduced	Full
Custom	Reduced	Reduced	Full
Milling	Reduced	Full	Full

Reduced= Brushes, conveyor and fan turn at reduced speed.  
Full= Brushes, conveyor and fan turn at full speed.

**SETTING THE CUSTOM MODE**

1. Scroll through the different sweep modes using the sweep mode switch, until the custom mode appears on the screen.

2. Press the more switch to scroll through the operational screens and access the CUSTOM SETTINGS screen.

*NOTE: The CUSTOM SETTINGS screen appears only when the machine sweep mode is set to CUSTOM.*

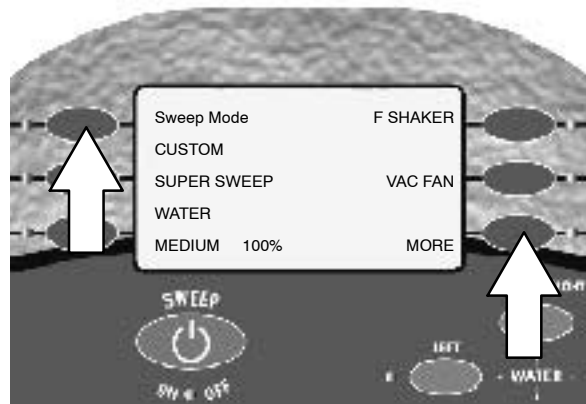

3. Scroll through the different settings for each of the sweeping functions shown on the screen. The setting that appears beneath each of the sweeping functions is the setting that the sweeping function will default to, when the CUSTOM mode is chosen with the SWEEP MODE switch.

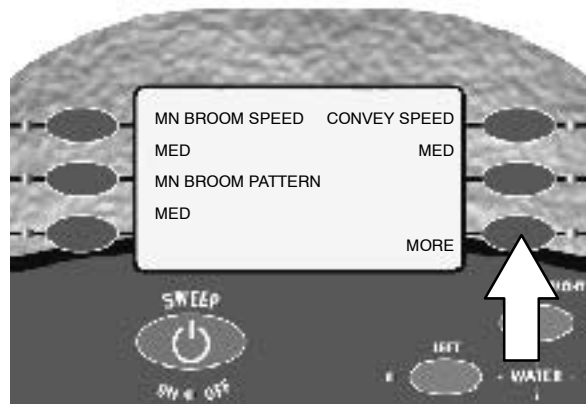

4. Press the MORE switch to scroll out of the CUSTOM SETTINGS screen when all of the settings are chosen.

## FILLING THE WATER TANK

1. Start the machine. See the STARTING THE MACHINE section of the manual.

**FOR SAFETY: Do not operate machine unless all TENNANT and truck manuals are read and understood.**

2. Drive the machine to the water tank filling site or water hydrant.

**FOR SAFETY: When using machine, always follow safety and traffic rules.**

**NOTE: Contact local city municipality for water hydrant access information.**

3. Press your foot on the brake pedal, and set the machine parking brake.

**FOR SAFETY: Before leaving or servicing machine, stop on level surface and set parking brake.**

4. Open the rear machine door and locate the water fill hose stored in the rear of the machine.

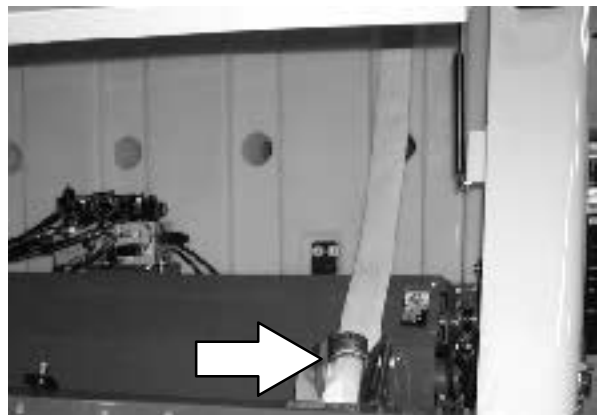

5. Remove the hose from the rear of the machine. Connect the water hose to the water valve or hydrant.

**FOR SAFETY: Wear eye and ear protection when using pressurized air or water.**

**NOTE: Contact local city municipality for water hydrant access information.**

*NOTE: Flush the hydrant before filling the water tank.*

*NOTE: The hydrant wrench (option) is stored next to the water hose in the rear of the machine.*



6. Fill the water tank.

**FOR SAFETY: Wear eye and ear protection when using pressurized air or water.**

7. Close the valve or hydrant when the tank is full. Fold the water hose back into the storage location. Place the hydrant wrench (option) back in the storage position next to the hose.

8. Close the rear machine door.



# OPERATION

## SWEEPING

1. Press the *sweep switch*. This will lower and start the sweeping functions. The lights next to these switches will come on. The touch panel will display a SWEEPER TURNING ON message for a few seconds, and then display the SWEEP MODE screen.

*NOTE: See the ALARMS section of the manual if any alarms sound and appear on the display panel while sweeping.*

*NOTE: The sweep mode, water flow rate, gutter broom(s), and vacuum fan will default to the last setting used when the sweeping operations are started.*



2. Press the *water spray switch(es)* to start the *wet dust control system*. The light(s) next to the switch(es) will come on.

*NOTE: The wet dust control system will automatically turn on with the SWEEP SWITCH **IF** the water spray switches were in the **on** position when the sweep switch was last turned off.*

*NOTE: Do not use the wet dust control when sweeping in wet conditions. Heavy snow and or/moisture may cause compacted debris to stick in the hopper.*

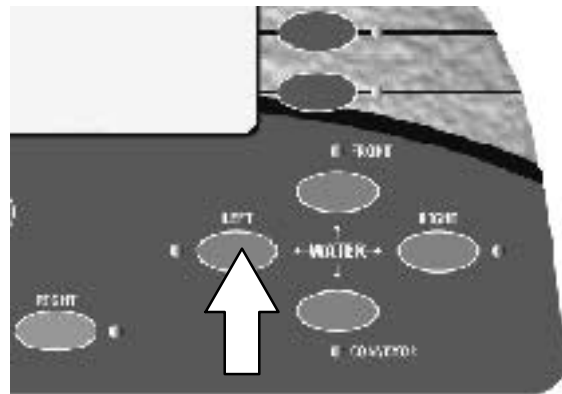

3. Press the *gutter broom switch(es)*. This will lower and start the gutter broom(s). The light(s) next to the switch(es) will come on.

*NOTE: The gutter broom(s) will automatically turn on with the SWEEP SWITCH **IF** they were in the **on** position when the sweep switch was last turned off.*

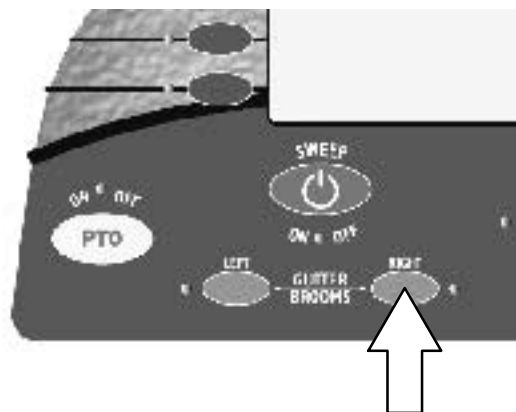



4. Check that the machine is in the best range for the chosen sweeping mode.

*NOTE: For best slow speed sweeping results, drive the machine in D1 (first gear) with the differential in low range.*

**FOR SAFETY: Do not operate machine unless all TENNANT and truck operation manuals are read and understood.**

5. Press your foot on the brake pedal, and release the parking brake.
6. Press the throttle pedal and start sweeping.
7. Activate the filter shaker frequently when sweeping in high dust areas, or if the SHAKE FILTER ALARM sounds.

*NOTE: The SHAKE FILTER ALARM will sound and appear when the hopper filter is full of debris, unless the machine is equipped with the dry dust control (option).*

The touch panel will display a SHAKER PROCESS BEGINNING message for a few seconds, and the light next to the switch will come on. The filter will shake for about 60 seconds, then it will stop and the light next to the switch will turn off.

8. Stop sweeping if the CONVEYOR STALL ALARM sounds. This alarm means that a large object is jammed in the conveyor.

*NOTE: The CONVEYOR STALL alarm will sound and appear when an object is jammed in the conveyor.*

To clear the jammed object, press and hold the conveyor reverse switch for 10-15 seconds until the debris is removed.

*NOTE: Do not operate the conveyor in reverse for more than 15 seconds at a time. The belt can become misaligned and damage to the machine can occur.*



## STOP SWEEPING

1. Press the *sweep switch*. This will raise and stop the sweeping functions. The lights next to these sweeping function switches will turn off. The touch panel will display a SWEEPER TURNING OFF message for a few seconds, and then display the SWEEP MODE screen.



2. Check to make sure all the sweeping function lights are out. If any lights are lit, press the switch to turn it off.

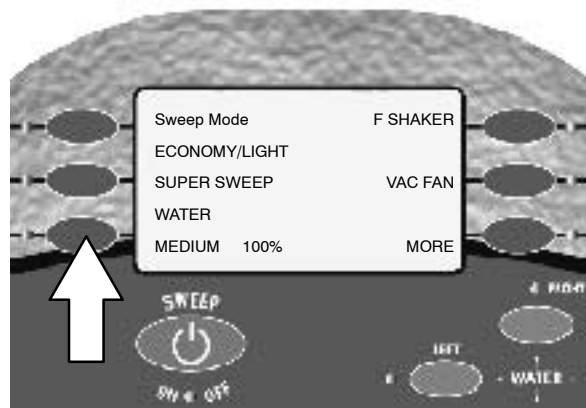

3. Press the *filter shaker switch* to clean the hopper filter. The filter will shake for about 60 seconds. The light next to the switch will come on while the filter is shaking, then turn off.

**NOTE:** Shake the dust filter **before and while** emptying the hopper to assist in removal of debris from hopper and filter compartment.

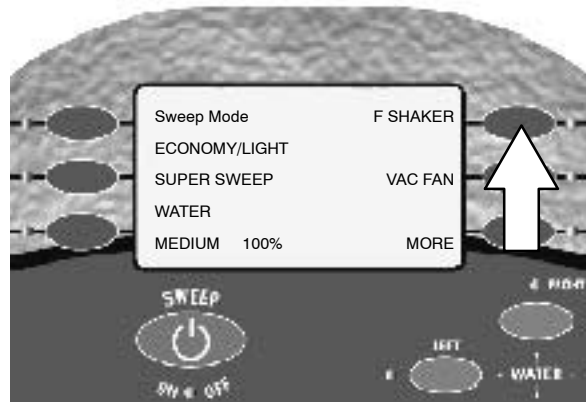

**EMPTYING THE HOPPER**

1. Drive the machine slowly to the debris collection site or debris container. Make sure the machine is on level ground before dumping the hopper.

*NOTE: The MACHINE NOT LEVEL ALARM will sound and appear if a hopper lift is attempted and the machine is on an incline that is unsafe for high dumping.*

**FOR SAFETY: When using machine, only dump the hopper on a level surface.**

2. Press and hold the brake pedal with your foot. Place the machine in neutral, then engage the parking brake.

*NOTE: The ACTIVATE PARK BRAKE ALARM will sound and appear if a hopper lift is attempted and the parking brake is not set.*



3. Press and hold the *hopper up* switch until the hopper is at the desired raised position, then release the switch. An audio alarm will sound while the hopper is moving.

**WARNING:** High dump vertical clearance. Stay clear of overhead obstructions and power lines.

*NOTE: The ACTIVATE PARK BRAKE ALARM will sound and appear if a hopper lift is attempted and the parking brake is not set.*

**FOR SAFETY: Do not move machine when hopper is raised.**

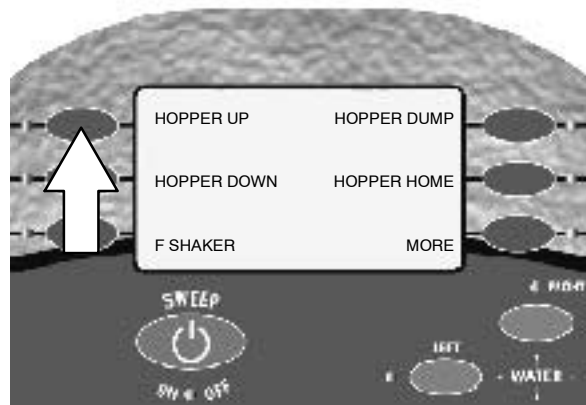

## OPERATION

- Press and hold the hopper dump switch until the hopper is tilted, the hopper doors are opened and the debris falls out of the hopper.

*NOTE: The ACTIVATE PARK BRAKE ALARM will sound and appear if a hopper dump is attempted and the parking brake is not set.*

*NOTE: Shake the dust filter **before and while** emptying the hopper to assist in removal of debris from hopper and filter compartment.*

- Check the hopper for any remaining debris after dumping. If there is still debris in the hopper, lower to remove the debris.
- Press and hold the *hopper home* switch until the hopper is back in the level position, then release the switch.

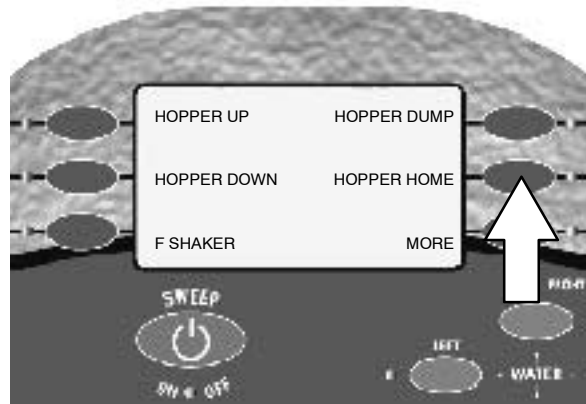
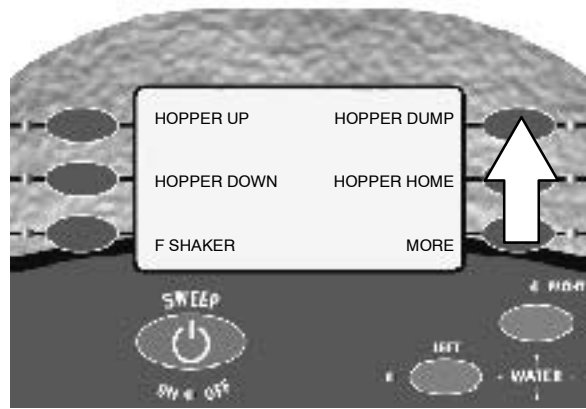

- Press and hold the *hopper down* switch until the hopper is back in the down position, then release the switch. An audio alarm will sound while the hopper is moving.

- Check the HOPPER CONTROL screen to make sure that all the hopper switch lights are off. The hopper must be in a fully lowered and level position with the hopper door closed before sweeping again.

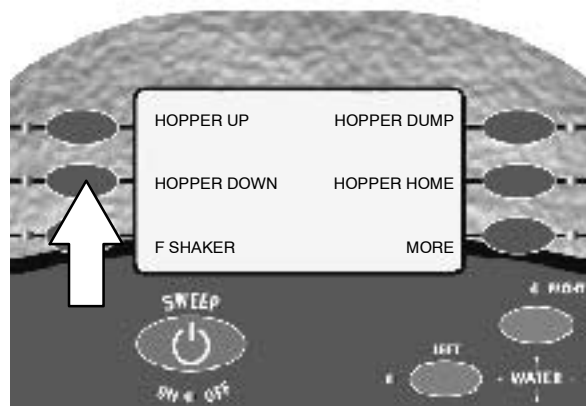

---

**STOPPING THE MACHINE**

---

1. Stop sweeping. Refer to the *STOP SWEEPING* section of this manual.
2. Take your foot off the throttle pedal. Step on the brake pedal.
3. Shift the truck from D (Drive) to N (Neutral).



4. Activate the parking brake.

**FOR SAFETY: Before leaving or servicing machine, stop on level surface, set parking brake, turn off machine and remove key.**



5. Turn the key to the off position.

6. Check that all machine accessories are turned off before turning machine off.



# OPERATION

## POST-OPERATION CHECKLIST

- Check the main brush pattern for taper. See *TO CHECK AND ADJUST MAIN BRUSH PATTERN* in the *MAINTENANCE* section of this manual.
- Check the brush skirts for damage and wear.
- Check the conveyor skirts for damage and wear.
- Check for wire or string tangled on the main broom and gutter brooms.
- Check for fuel odor that indicates a fuel leak.
- Check under the machine for leak spots (fuel, oil, coolant).
- Check the conveyor for damage and misalignment.
- Wash the machine.
- Flush the conveyor.
- Check the hopper for jammed debris.
- Check that the water tank is empty if storing for a long period of time.
- Check the service records to determine maintenance requirements.

## OPERATION ON INCLINES

Drive the machine slowly on inclines and make sure your seat belt is fastened. Use the brake pedal to control machine speed on descending inclines.

Do not drive the machine with the hopper raised.

**FOR SAFETY: Do not move machine when hopper is raised.**

The *machine not level alarm* will come on when the machine is on an incline that is unsafe for high dumping the hopper. It will come on when the side to side incline is more than 5°. The hopper will not lift or dump when this alarm is on.



**ENGAGING HOPPER TILT SUPPORT BAR**

1. Start the machine. See the STARTING THE MACHINE section of the manual.



2. Park the machine on a level surface. Activate the parking brake.

**FOR SAFETY: Before leaving or servicing machine, stop on level surface and set parking brake.**



3. Press and hold the *hopper dump* switch until the hopper is in the fully tilted position.

**WARNING:** Lift arm pinch point. Stay clear of hopper lift arms.

*NOTE: The ACTIVATE PARK BRAKE ALARM will sound and appear if a hopper dump is attempted and the parking brake is not set.*



## OPERATION

4. Remove the hopper tilt support bar from the storage location in the rear of the machine.

 **WARNING: Lift arm pinch point.**  
Stay clear of hopper lift arms.

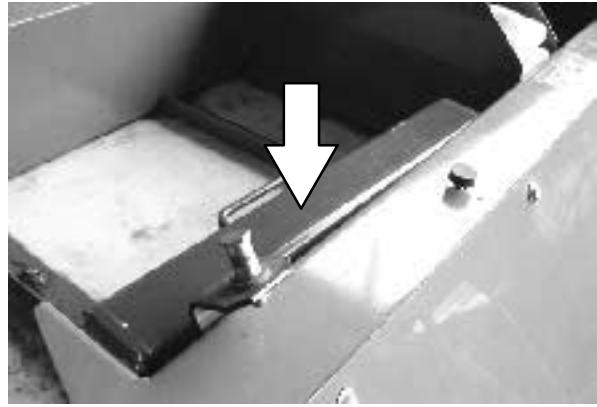

5. Install the hopper tilt support bar in place over one of the extended cylinder rods.

 **WARNING: Tilted hopper may fall.**  
Engage hopper support bar.



6. Press and hold the *hopper home* switch for a few seconds, until the hopper rests on the hopper tilt support bar.

7. Turn the key counter-clockwise to stop the engine. Remove the switch key.

**FOR SAFETY: Before leaving or servicing machine, stop on level surface, set parking brake, turn off machine and remove key.**





**DISENGAGING HOPPER TILT SUPPORT BAR**

1. Start the machine. See the STARTING THE MACHINE section of the manual.



2. Activate the parking brake.

**FOR SAFETY: Before leaving or servicing machine, stop on level surface and set parking brake.**



3. Press and hold the *hopper dump* switch until the hopper is in the fully tilted position.

*NOTE: The ACTIVATE PARK BRAKE ALARM will sound and appear if a hopper dump is attempted and the parking brake is not set.*



## OPERATION

4. Remove the hopper tilt support bar from the extended lift cylinder.

 **WARNING: Lift arm pinch point.**  
Stay clear of hopper lift arms.



5. Replace the hopper tilt support bar in the storage location in the rear of the machine.



6. Press and hold the *hopper home* switch until the hopper is back in the level position, then release the switch.

 **WARNING: Lift arm pinch point.**  
Stay clear of hopper lift arms.

7. Turn the key counter-clockwise to stop the engine. Remove the switch key.

**FOR SAFETY: Before leaving or servicing machine, stop on level surface, set parking brake, turn off machine and remove key.**



**ENGAGING HOPPER LIFT SUPPORT BARS**

1. Start the machine. See the STARTING THE MACHINE section of the manual.



2. Park the machine on a level surface. Activate the parking brake.

**FOR SAFETY: Before leaving or servicing machine, stop on level surface and set parking brake.**



3. Press and hold the *hopper up* switch until the hopper is in the fully raised position, then release the switch. An audio alarm will sound while the hopper is moving.

**WARNING:** Lift arm pinch point. Stay clear of hopper lift arms.

**WARNING:** High dump vertical clearance. Stay clear of overhead obstructions and power lines.

*NOTE: The ACTIVATE PARK BRAKE ALARM will sound and appear if a hopper lift is attempted and the parking brake is not set.*



## OPERATION

- Lower both of the hopper lift support bars off of the hopper lift and down to the track in the hopper lift support frame.

 **WARNING: Raised hopper may fall. Engage hopper support bar.**

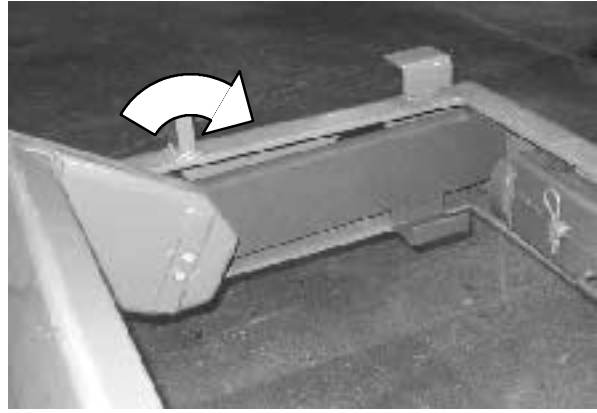

- Press and hold the *hopper down switch* for a few seconds, until the hopper lift rests against the hopper lift support bars.

 **WARNING: Lift arm pinch point. Stay clear of hopper lift arms.**

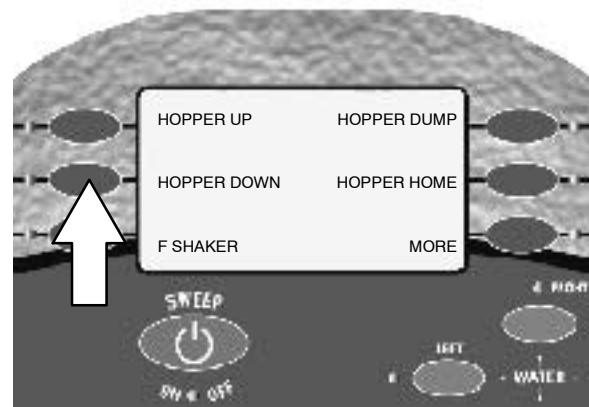

- Turn the key counter-clockwise to stop the engine. Remove the switch key.

**FOR SAFETY: Before leaving or servicing machine, stop on level surface, set parking brake, turn off machine and remove key.**



**DISENGAGING HOPPER LIFT SUPPORT BARS**

1. Start the machine. See the STARTING THE MACHINE section of the manual.



2. Activate the parking brake.

**FOR SAFETY: Before leaving or servicing machine, stop on level surface and set parking brake.**



3. Press and hold the *hopper up* switch until the hopper is in the fully raised position, then release the switch. An audio alarm will sound while the hopper is moving.

**WARNING:** High dump vertical clearance. Stay clear of overhead obstructions and power lines.

**NOTE:** The **ACTIVATE PARK BRAKE ALARM** will sound and appear if a hopper lift is attempted and the parking brake is not set.



## OPERATION

4. Raise both of the hopper lift support bars out of the hopper frame and rest them up on the hopper lift.

 **WARNING: Lift arm pinch point.**  
Stay clear of hopper lift arms.

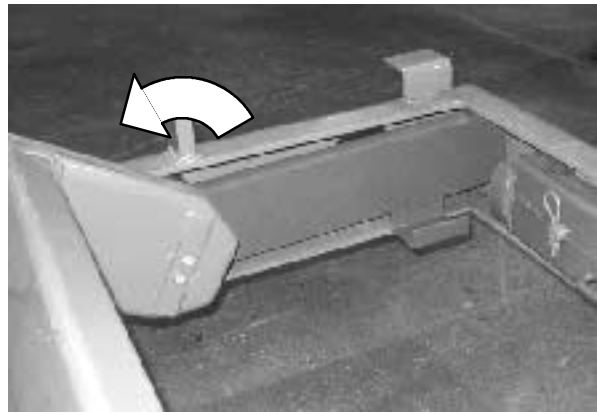

5. Press and hold the *hopper down switch* until the hopper is back in the down position, then release the switch. An audio alarm will sound while the hopper is moving.

 **WARNING: Lift arm pinch point.**  
Stay clear of hopper lift arms.

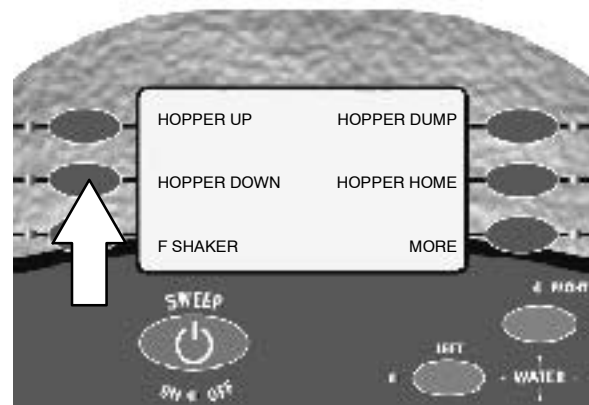

6. Turn the key counter-clockwise to stop the engine. Remove the switch key.

**FOR SAFETY: Before leaving or servicing machine, stop on level surface, set parking brake, turn off machine and remove key.**



**MACHINE TROUBLESHOOTING**

Problem	Cause	Remedy
Machine does not start	Engine air heater not heated	Heat engine air heater
	Fuel tank empty	Fill fuel tank
	Engine temperature too high	Check coolant level
Excessive dusting	Brush skirts and dust seals worn, damaged, out of adjustment	Replace or adjust brush skirts or dust seals
	Hopper dust filter clogged	Shake and/or clean or replace dust filter
	Vacuum fan not on	Turn vacuum fan on
	Vacuum fan failure	Contact service personnel
	Water tank empty	Fill water tank
	Wet dust water pump or valves not turned on	Turn on the wet dust control water pump and valves
Sweep switch will not activate	Hopper not fully lowered	Lower hopper fully
	Engine RPM too high	Lower RPM < 950 RPM
	Hydraulic fluid level low	Check hydraulic fluid level
	Main brush worn	Replace main brush
Hopper will not lift or tilt	Machine on too steep of an incline	Move machine to a level surface
	Park or service brake not applied	Apply park or service brake
	Hopper overloaded	Remove debris from hopper
	Hydraulic fluid level low	Check hydraulic fluid level
Machine will not propel	Brake pressure too low	Contact service personnel
	Parking brake on	Release parking brake
	Pushbutton range selector in N (neutral)	Change pushbutton range selector from N (neutral) to D (drive)

# OPERATION

## MACHINE TROUBLESHOOTING

Problem	Cause	Remedy
Poor sweeping performance	Brush bristles worn	Replace brushes
	Wrong sweeping brush	Contact TENNANT representative for recommendations
	Main brush or gutter broom not adjusted properly	Adjust main brush or gutter broom
	Main brush or gutter broom failure	Contact TENNANT service personnel
	Debris caught in main brush drive mechanism or conveyor	Free drive mechanism or conveyor of debris
	Conveyor failure	Contact service personnel
	Conveyor skirts worn or damaged	Replace conveyor skirts
	Hopper full	Empty hopper
	Hopper not down completely	Lower hopper completely
	Vacuum fan not on	Turn vacuum fan on
	Vacuum fan on while sweeping wet debris	Turn vacuum fan off
	Vacuum fan failure	Contact TENNANT service personnel
	Worn drag shoes	Replace drag shoes
	Drag shoes not completely down	Check for obstruction then lower drag shoes completely
	Drag shoes not adjusted correctly	Check that hash marks on flanges are aligned
Drag shoe pivot loose	Retighten pivot joint	



MAINTENANCE

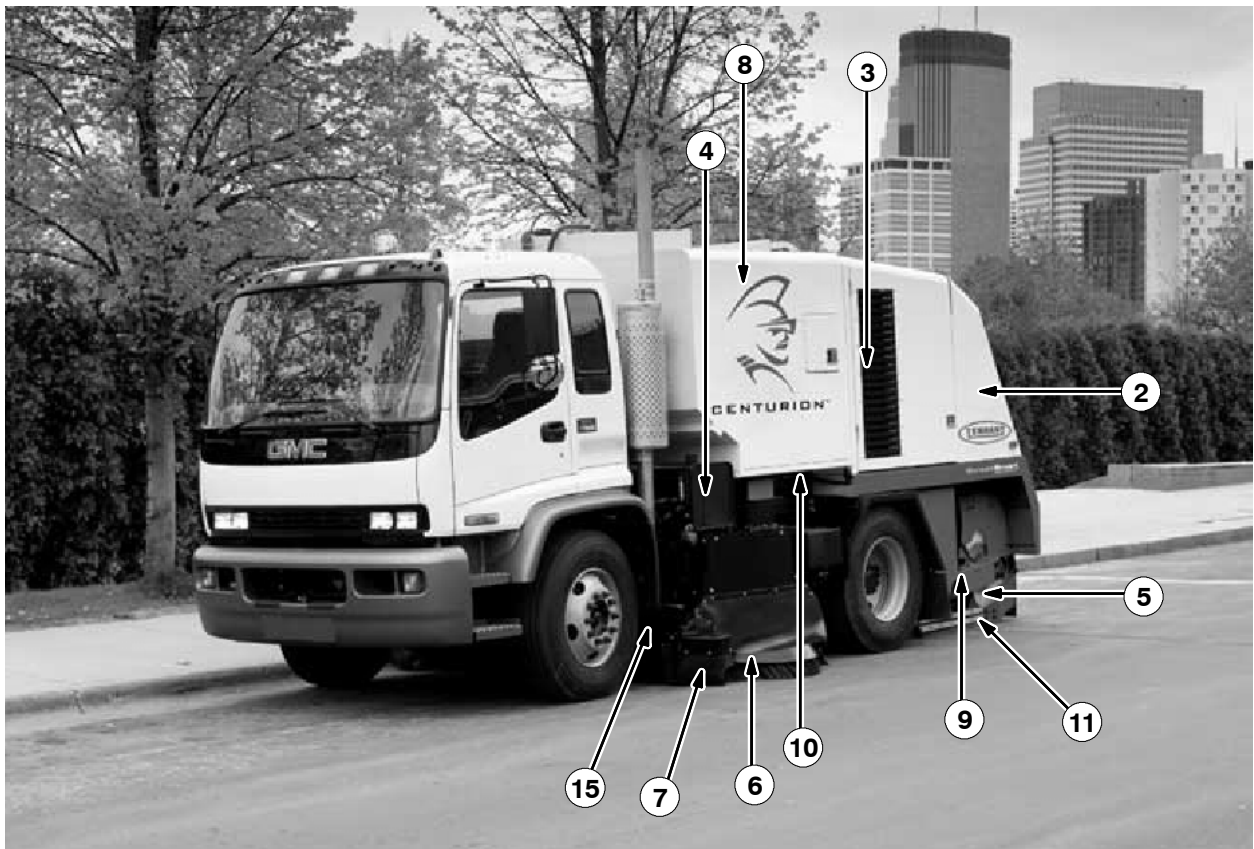
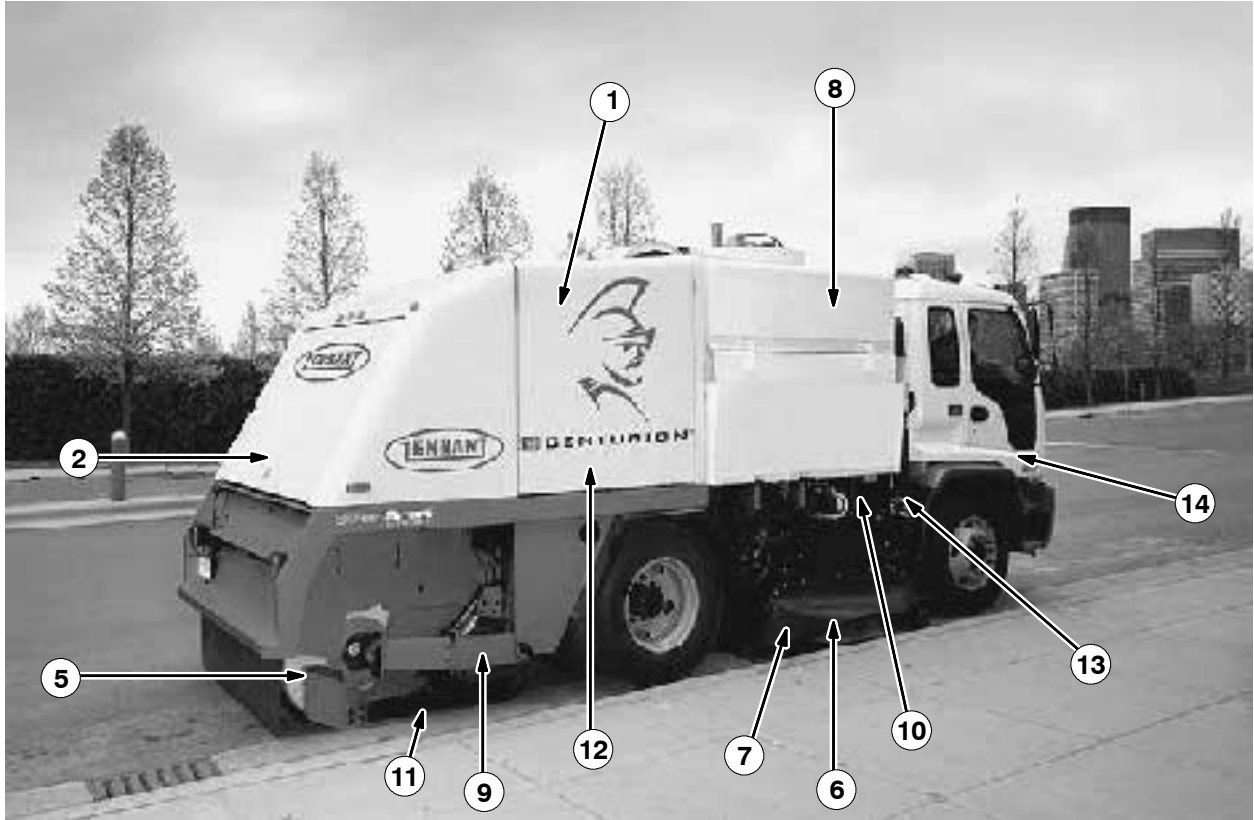

# MAINTENANCE

## MAINTENANCE CHART

**NOTE: Refer to truck manufacturer's owner's manual for procedures indicated (\*)**

**NOTE: Also check procedures indicated (\*\*) after the first 50-hours of operation**

**NOTE: More frequent intervals may be required in extremely dusty conditions.**

Interval	Key	Description	Procedure	Lubricant/ Fluid	No. of Service Points
Daily	1	Conveyor	Check belt for damage and wear	-	1
			Check tracking	-	1
			Flush lower roller	-	1
			Check tension springs	-	2
			Lubricate roller bearings	WBG	4
	1	Conveyor skirts and cleats	Check for damage and wear and proper fit	-	All
	13	Engine air filter (*)	Check air flow indicator	-	All
			Clean element as required	-	All
	14	Engine crankcase (*)	Check oil level	EO	1
	14	Engine radiator	Check and clean cooler fins	-	-
	3	Hydraulic fluid cooler	Check and clean cooler fins	-	2
	4	Hydraulic fluid reservoir	Check fluid level	HYDO	1
	5	Main brush	Check for damage, wear, and adjustment	-	1
			Check brush pattern	-	1
		Brush compartment skirts	Check for damage and wear	-	3
	9	Main brush support arms	Lubricate support arms	WBG	4
	6	Gutter broom(s)	Check for damage and wear	-	2
	8	Hopper dust filter	Shake	-	1
		Hopper	Check for damage and wear	-	1
			Wash or rinse	-	1
		Hopper full sensor	Wash or rinse	-	1
	12	Auto lube (option)	Check for leaks and damage	-	All
	12	Water filter/Wet dust control system	Check filter/spray nozzles for debris and adjustment	-	All
-	Overall machine	Wash machine	-	All	
40 Hours	6	Gutter broom(s)	Lubricate support arms, rods and pivots	WBG	10-14
	7	Dry dust control skirts and bumpers (option)	Lubricate cylinder and pivots	WBG	7
			Check for damage and wear	-	5
	2	Main brush and drag shoe lift cylinders and tubes (**)	Lubricate	WBG	8
	11	Drag shoes	Check for wear	-	2
Lubricate lift pivot			WBG	2	

Interval	Key	Description	Procedure	Lubricant/ Fluid	No. of Service Points
100 Hours	1	Conveyor	Lubricate lift pivots and cylinders	WBG	10
			Check height adjustment	-	2
	14	Engine crankcase (*)	Change oil and filter	EO	1
	5	Brush compartment, conveyor and hopper seals	Check for damage or wear	-	All
	7	Gutter broom dust control skirts (option)	Check for damage and wear	-	All
	7	Gutter broom dry dust control skirt pivots (option)	Lubricate	-	All
	15	Propulsion shafts	Lubricate slip joints	WBG	2
			Check joints for play	-	2
	10	Conveyor tilt cylinder (**)	Lubricate	WBG	2
10	Hopper lift/tilt	Lubricate	WBG	2	

200 Hours	9	Main brush	Lubricate idler bearing	WBG	1		
	-	Hydraulic hoses	Check for damage and wear	-	All		
			12	Wet dust control system	Check water tank for damage	-	1
					Check water pump	-	1
					Check water hoses for wear	-	All
					Clean water filter	-	1
250 Hours	14	Engine crankcase (*)	Initial Engine Valve Lash Inspection/Adjustment	-	All		
800 Hours	4	Hydraulic reservoir	Replace filler cap	-	1		
			Change hydraulic fluid	HYDO	1		
	3	Hydraulic fluid filter	Change filter element	-	1		
	3	Hydraulic pump load sense filter	Check and/or change filter element	-	2		
	12	Wet dust control system	Check water tank hoses and clamps for wear tension or damage	-	1		

**LUBRICANT/FLUID**

EO . Engine oil, SAE-CD/SE rated

HYDO . TENNANT or approved hydraulic fluid

WBG .. Waterproof bearing grease (TENNANT part no. 765819)

**NOTE: The maintenance chart covers the sweeper maintenance only. Refer to Chassis and Transmission owner's manuals for recommended service intervals of chassis, engine and transmission.**

## LUBRICATION

### HOPPER LIFT/TILT

The high dump hopper lift has twenty six lubrication points. Four grease fittings are located on the upper tilt cylinders, one on each end of the two cylinders. Four grease fittings are located on the lower lift cylinders, one at each end of the two cylinders. Four lubrication points are located on the lift rollers. Two grease fittings are located at the hopper tilt pivot, one on each side. The last twelve grease fittings are located on the pivots of the hopper lift arms. Lubricate these fittings with Waterproof Bearing grease (TENNANT part no. 765819) after every 100 hours of operation.

**⚠ WARNING: Raised hopper may fall. Engage hopper support bar.**

**⚠ WARNING: Tilted hopper may fall. Engage hopper support bar.**

**⚠ WARNING: High dump vertical clearance. Stay clear of overhead obstructions and power lines.**

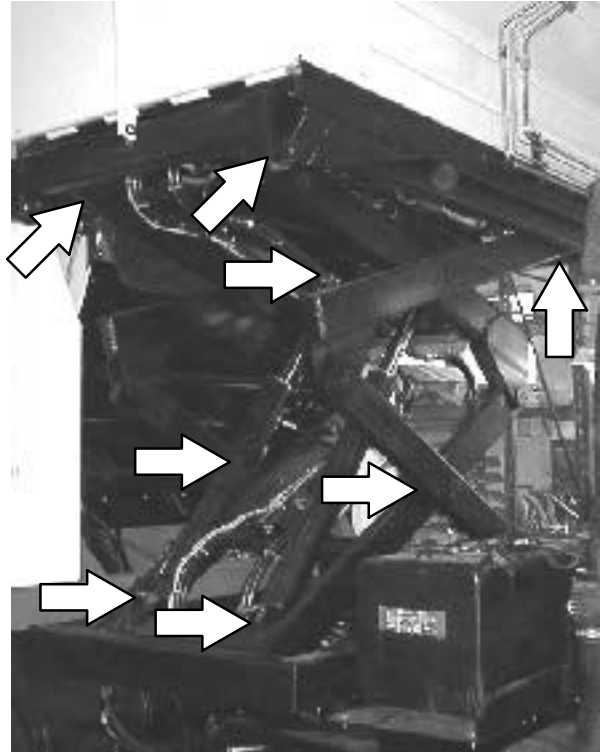

### ENGINE

Check the engine oil level daily. Change the engine oil and oil filter every 100 hours of operation.

Fill the engine with 15W40 SAE-CH-4/CG-4 rated engine oil, to the level indicated on the oil dipstick. The engine oil capacity is 21 L (22 qt) including the oil filter.

**FOR SAFETY: When servicing machine, avoid moving parts. Do not wear loose jackets, shirts or sleeves.**

**GUTTER BROOM SUPPORT RODS**

Each gutter broom support rod has a grease fitting on each end. Lubricate with Waterproof Bearing grease (TENNANT part no. 765819) after every 40 hours of operation.

**⚠ WARNING: Brush linkage pinch points. Stay clear when linkage is moving.**

**⚠ WARNING: Side brush can move. Do not step on side brush.**

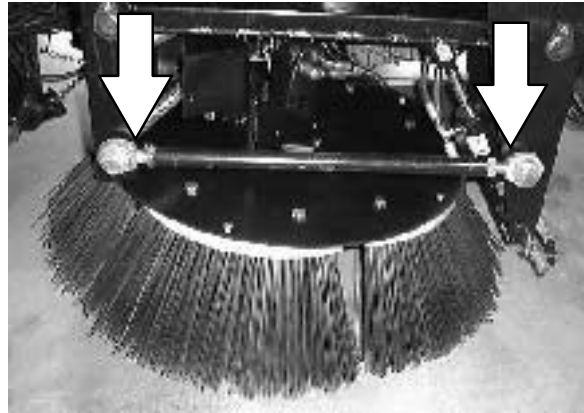

**GUTTER BROOM SUPPORT ARMS**

Each gutter broom support arm has a grease fitting on the bearing on each end. Lubricate with Waterproof Bearing grease (TENNANT part no. 765819) after every 40 hours of operation.

**⚠ WARNING: Brush linkage pinch points. Stay clear when linkage is moving.**

**⚠ WARNING: Side brush can move. Do not step on side brush.**

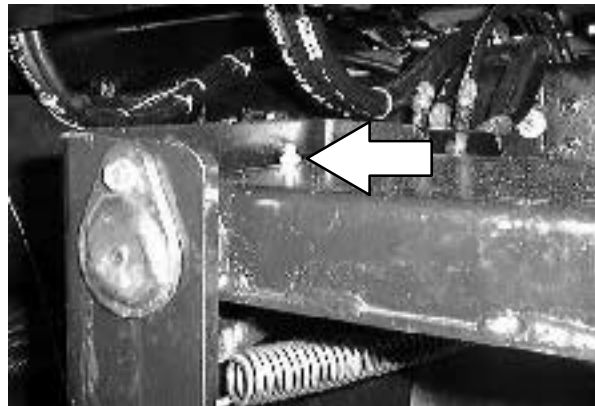

**GUTTER BROOM PIVOT**

Each gutter broom drive motor has a grease fitting on the drive motor pivot point. Lubricate with Waterproof Bearing grease (TENNANT part no. 765819) after every 40 hours of operation.

**⚠ WARNING: Brush linkage pinch points. Stay clear when linkage is moving.**

**⚠ WARNING: Side brush can move. Do not step on side brush.**

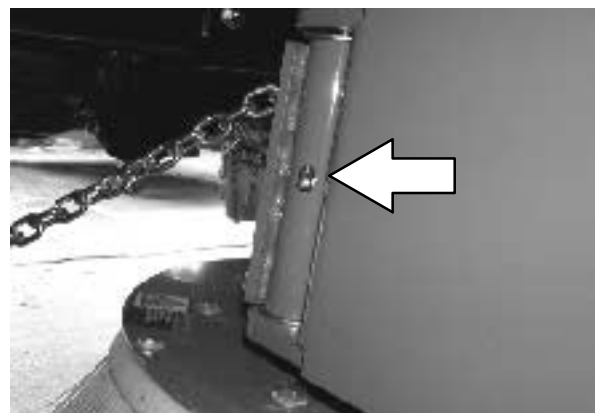

## MAINTENANCE

### DUST CONTROL SKIRT CYLINDER (OPTION)

The gutter broom dust skirt cylinder has a lubrication point on one end. Lubricate with Waterproof Bearing grease (TENNANT part no. 765819) after every 40 hours of operation.

 **WARNING: Brush linkage pinch points.**  
Stay clear when linkage is moving.

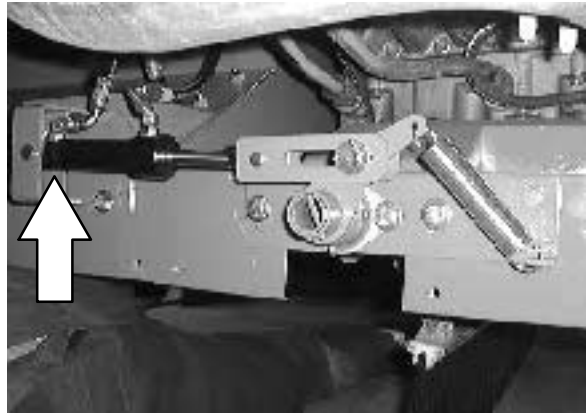

### DUST CONTROL SKIRT PIVOTS (OPTION)

The gutter broom dust control skirt shaft has one grease fitting on each end of the shaft. Lubricate with Waterproof Bearing grease (TENNANT part no. 765819) after every 40 hours of operation.

 **WARNING: Brush linkage pinch points.**  
Stay clear when linkage is moving.

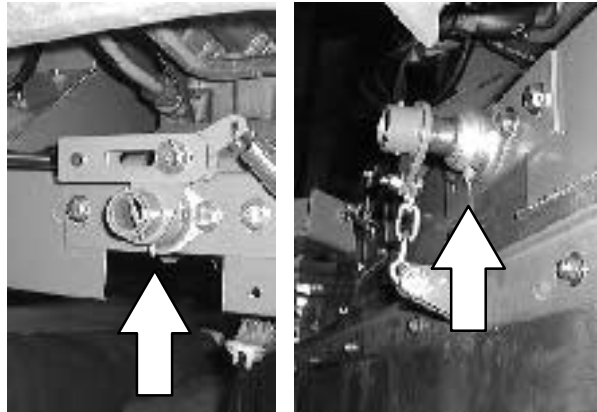

### DUST CONTROL BUMPER PIVOTS (OPTION)

The gutter broom dust control bumpers have one grease fitting on the inside of each pivot. Lubricate with Waterproof Bearing grease (TENNANT part no. 765819) after every 40 hours of operation.

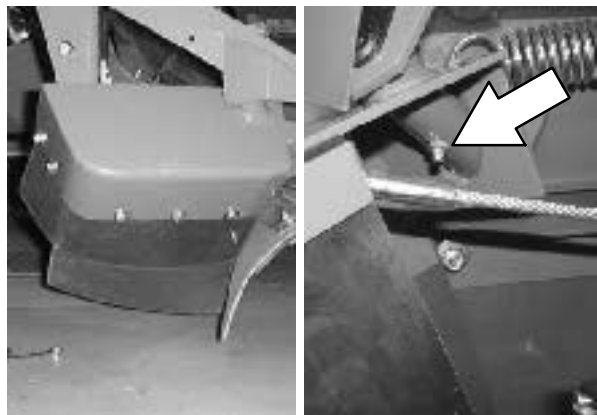

**MAIN BRUSH SUPPORT ARMS**

The main brush support arms have a total of four grease fittings, two on each side. Lubricate with Waterproof Bearing grease (TENNANT part no. 765819) daily.

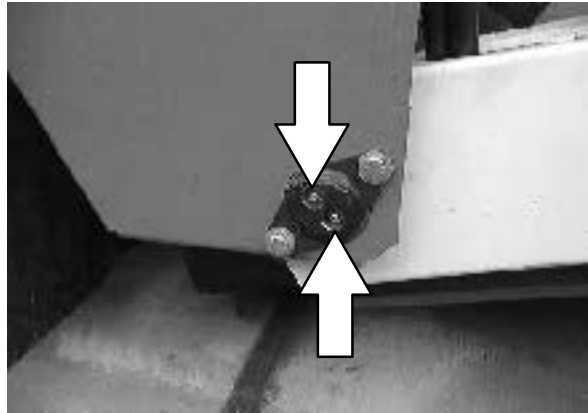
**MAIN BRUSH IDLER BEARING**

The main brush idler bearing has one grease fitting on the right hand side of the machine, opposite the main brush drive motor. Lubricate with Waterproof Bearing grease (TENNANT part no. 765819) after every 200 hours of operation.

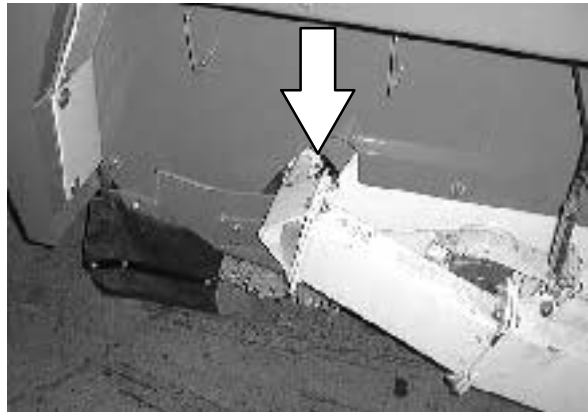
**DRAG SHOE PIVOT**

The drag shoe pivot has two grease fittings. One is located on each side of the machine. Lubricate with Waterproof Bearing grease (TENNANT part no. 765819) after every 40 hours of operation.

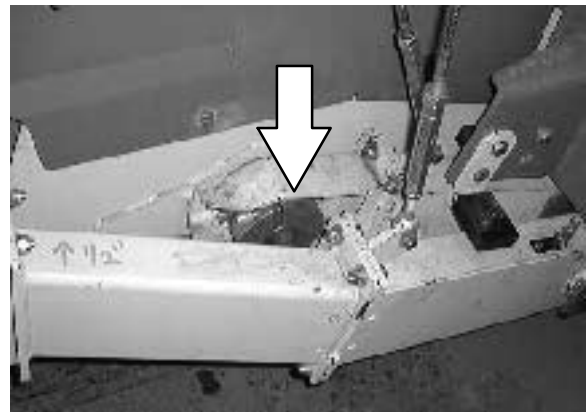

## MAINTENANCE

### MAIN BRUSH LIFT CYLINDER

The main brush lift cylinder has a total of two grease fittings, one on each end. Lubricate with Waterproof Bearing grease (TENNANT part no. 765819) after every 40 hours of operation.

 **WARNING: Brush linkage pinch points.**  
Stay clear when linkage is moving.

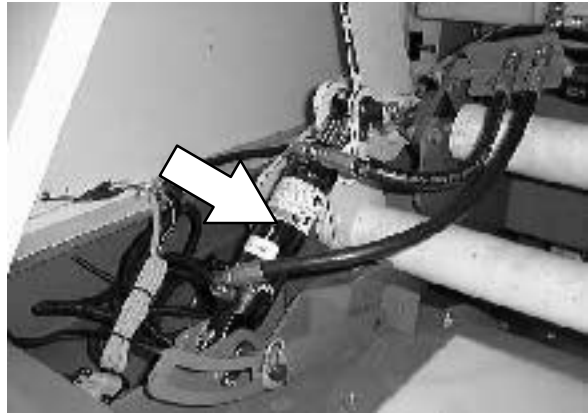

### DRAG SHOE LIFT CYLINDER

The drag shoe lift cylinder has two grease fittings, one on each end. Lubricate with Waterproof Bearing grease (TENNANT part no. 765819) after every 40 hours of operation.

 **WARNING: Brush linkage pinch points.**  
Stay clear when linkage is moving.

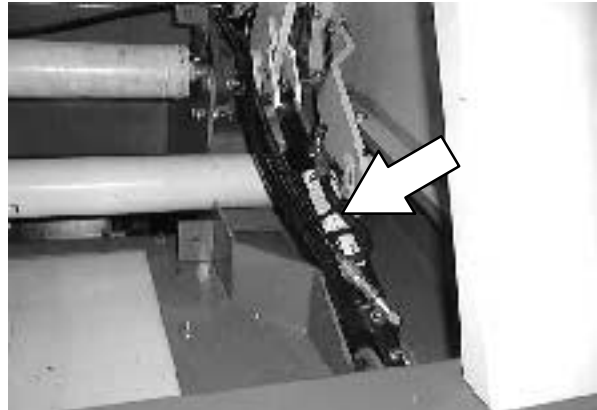

### MAIN BRUSH AND DRAG SHOE CYLINDERS

There is one bearing grease fitting on each end of the main brush and drag shoe cylinders. Lubricate with Waterproof Bearing grease (TENNANT part no. 765819) after every 40 hours of operation.

 **WARNING: Brush linkage pinch points.**  
Stay clear when linkage is moving.

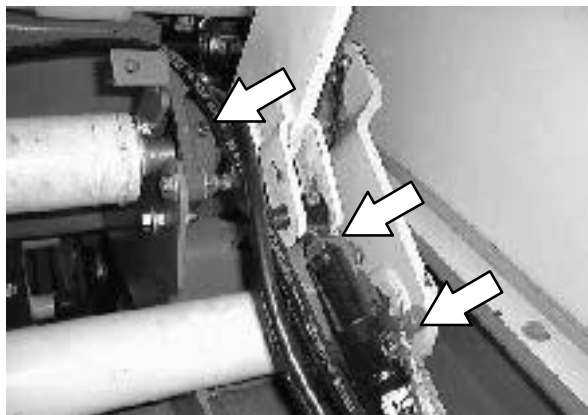



**CONVEYOR BEARINGS**

The four conveyor bearing lubrication points are mounted on the right side of the conveyor. They distribute grease to the conveyor bearings via plastic feed tubes.

**Lubricate each bearing daily** with Waterproof Bearing grease (TENNANT part no. 765819).

**⚠ WARNING: Conveyor throws debris. Conveyor pinch point. Stay clear when in operation.**

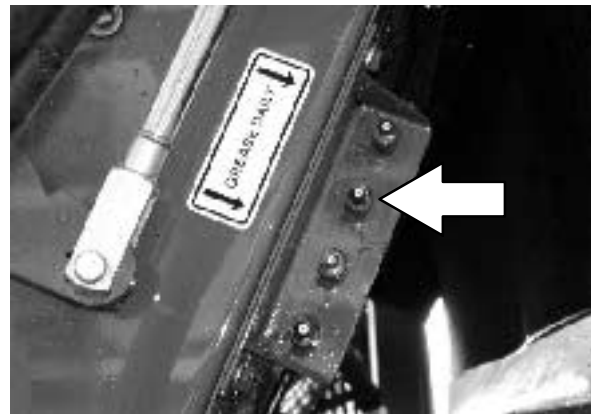

**CONVEYOR LIFT PIVOTS**

There is one grease fitting on each end of the conveyor lift shaft. Lubricate with Waterproof Bearing grease (TENNANT part no. 765819) after every 100 hours of operation.

**⚠ WARNING: Conveyor throws debris. Conveyor pinch point. Stay clear when in operation.**

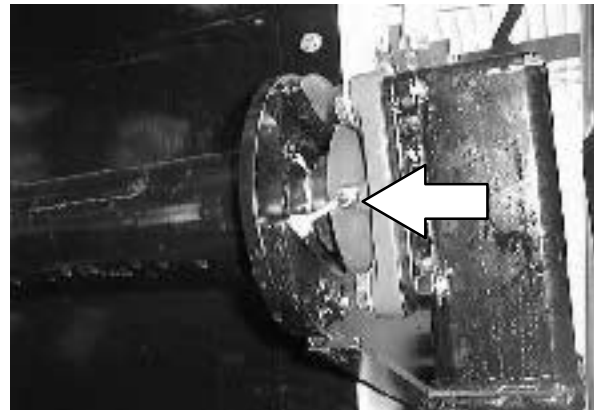

**CONVEYOR LIFT CYLINDERS**

The two conveyor lift cylinders each have two grease fittings, one at each end of each cylinder. There is also one grease fitting above and one grease fitting below each lift cylinder. Lubricate with Waterproof Bearing grease (TENNANT part no. 765819) after every 100 hours of operation.

**⚠ WARNING: Conveyor throws debris. Conveyor pinch point. Stay clear when in operation.**

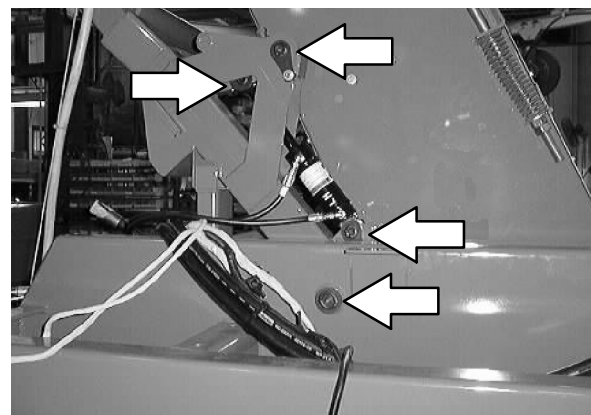

## MAINTENANCE

### CONVEYOR TILT CYLINDER

The conveyor tilt cylinder has one lubrication point on each end of the cylinder. Lubricate with Waterproof Bearing grease (TENNANT part no. 765819) after every 100 hours of operation.

 **WARNING: Conveyor throws debris. Conveyor pinch point. Stay clear when in operation.**

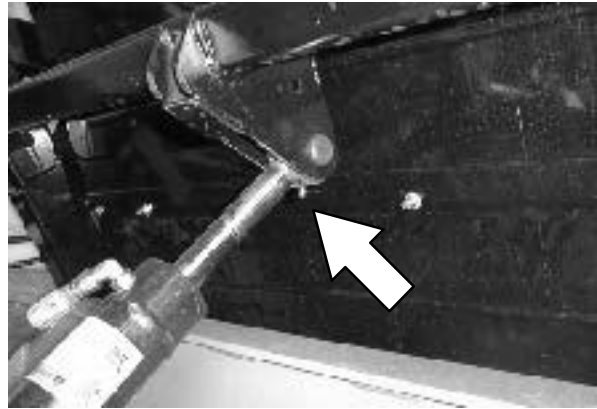

### DRY DUST CONTROL SKIRT WING PIVOTS (OPTION)

There is one lubrication point on each dry dust control skirt wing pivot. Lubricate with Waterproof Bearing grease (TENNANT part no. 765819) after every 100 hours of operation.

 **WARNING: Brush linkage pinch points. Stay clear when linkage is moving.**



### PROPULSION SHAFT SLIP JOINT

There is one propulsion shaft on each side of the machine. Each propulsion slip joint has one lubrication point. Lubricate with Waterproof Bearing grease (TENNANT part no. 765819) after every 100 hours of operation.

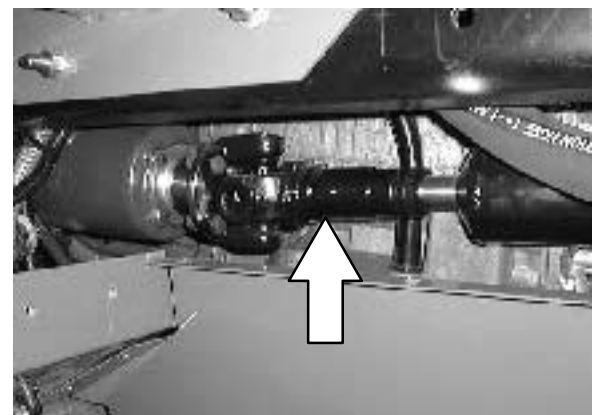

**AUTO LUBE (OPTION)**

The auto lube option supplies grease into the main supply lines for dispensing a precise amount of grease at each lube cycle.

Check the system daily for proper operation.

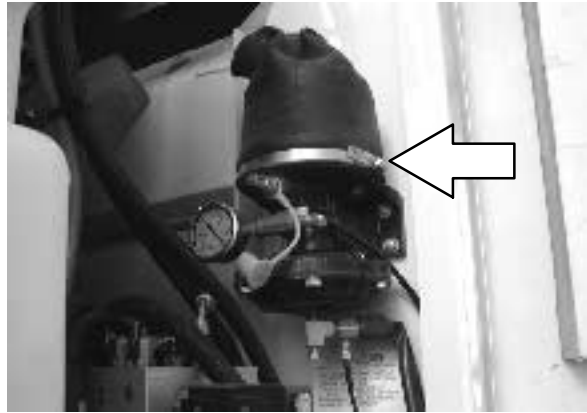

The fill tube is located below the reservoir. When using a flexible style reservoir, be sure the top of the bag is depressed inside the stiffener as far as possible to purge the air from the reservoir.

Fill the reservoir through the fill stud until it takes the original shape (top of reservoir slightly domed).

**NOTE: DO NOT OVER FILL RESERVOIR.**

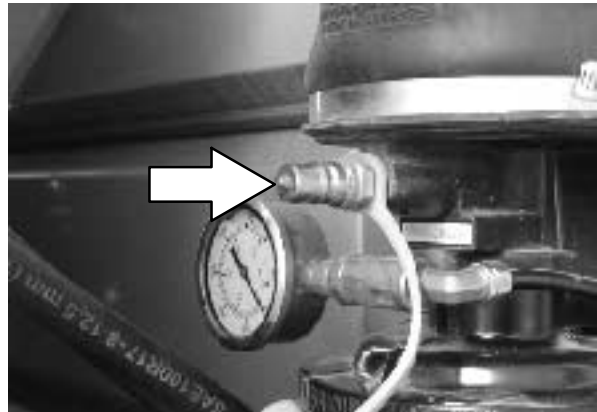

Heavy wall nylon tubing distributes grease throughout the system to each lubrication point.

Check the distribution lines daily for damage or leaks.

**NOTE: Refer to AUTO LUBE manual for standard maintenance procedures and AUTO LUBE troubleshooting chart.**



## HYDRAULICS

### HYDRAULIC FLUID RESERVOIR

The reservoir is located on the left side of the machine behind the cab.

Check the hydraulic fluid level at *operating temperature* daily. Make sure the hopper is down when checking hydraulic fluid level. The sight gauge is marked with full, the black line, and add, the red line, levels to indicate the level of hydraulic fluid in the reservoir. Cold fluid level is mid-point of add and full lines.

**ATTENTION! Do not overfill the hydraulic fluid reservoir or operate the machine with a low level of hydraulic fluid in the reservoir. Damage to the machine hydraulic system may result.**

 **WARNING: Burn hazard. Hot surface. Do not touch.**

The *hydraulic fluid low alarm* comes on when the hydraulic fluid level drops below the switch mounted in the front of the hydraulic tank. An audible alarm will sound once and the text message will appear on the display screen.

Check the hydraulic fluid reservoir, and fill with hydraulic fluid when the alarm comes on.

 **WARNING: Burn hazard. Hot surface. Do not touch.**

Drain and refill the hydraulic fluid reservoir with new hydraulic fluid every after every 800 hours of operation.

Mounted on top of the reservoir is a filler cap with a built-in breather. Replace the cap after every 800 hours of operation.

Lubricate the filler cap gasket with a film of hydraulic fluid before putting the cap back on the reservoir.

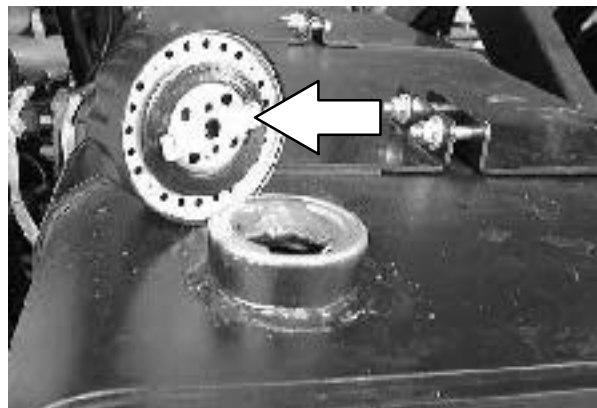
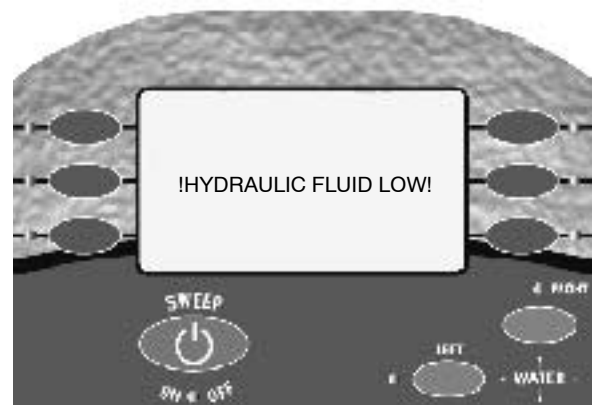
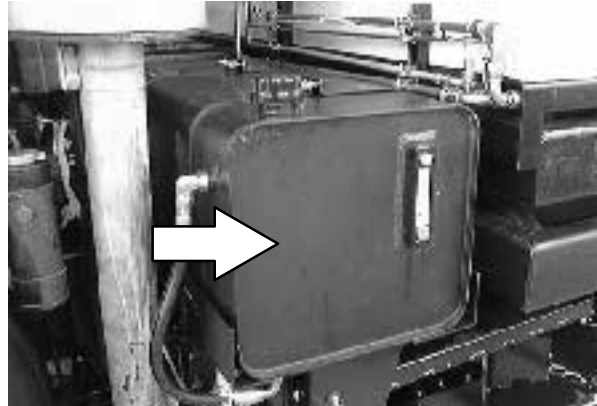

**HYDRAULIC FLUID**

The quality and condition of the hydraulic fluid play a very important role in how well the machine operates. TENNANT’s hydraulic fluid is specially selected to meet the needs of TENNANT machines.

TENNANT’s hydraulic fluids provide a longer life for the hydraulic components. There are two mineral based hydraulic fluids available and one synthetic hydraulic fluid available.

<b>TENNANT part no.</b>	<b>Ambient Temperature</b>
65869-5 (Mobil no. DTE18M)	warmer climates
65870-5 (Mobil no. DTE13M)	colder climates
Synthetic fluid (Mobil no. SHC-526)	all climates

The warmer climate fluid has a higher viscosity and should not be used in the colder climate states (see map). Damage to the hydraulic pumps may occur because of improper lubrication. When using warmer climate fluid, the machine should be stored inside when the temperatures drop below -1 C (30 F). If stored outside, only the PTO may be enabled when temperatures are below -10 C (15 F). The PTOs may not turn on when temperatures are below -15 C (5 F).

The colder climate fluid is a thinner fluid for colder temperatures.

Synthetic fluids offer several advantages. Their operating life is four times longer (3200 hours) than mineral based fluids (800 hours). Synthetic fluids can operate in a wider range of extreme temperatures. This feature is advantageous in states with wide seasonal temperature changes. (See map). The result is further increased component life.

**NOTE: DO NOT Mix Synthetic Hydraulic Fluid With Mineral Based Hydraulic Fluid.**

If a locally-available hydraulic fluid is used, make sure the specifications match TENNANT hydraulic fluid specifications. Using substitute fluids can cause premature failure of hydraulic components.

**ATTENTION! Hydraulic components depend on system hydraulic fluid for internal lubrication. Malfunctions, accelerated wear, and damage will result if dirt or other contaminants enter the hydraulic system.**

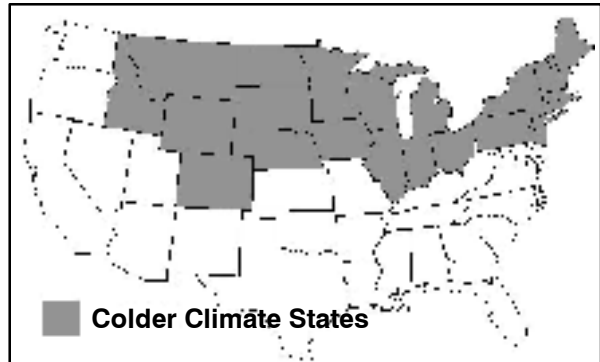

## MAINTENANCE

### HYDRAULIC PUMP LOAD SENSE FILTERS

The hydraulic pump load sense filters help keep the hydraulic pump orifices clean.

The hydraulic pump load sense filters are located inside the end of each hydraulic hose connected to the load sense port on the top of each hydraulic pump.

Check the filters for debris after every 800 hours of operation. Hold each filter up to a light to see how much of the filter may be blocked with debris. Replace the filters when over half of the filter appears to be blocked.

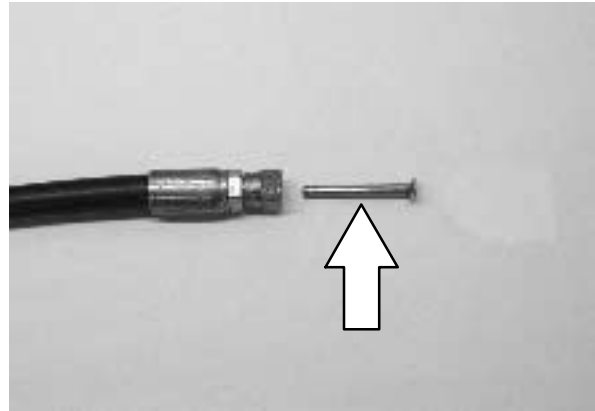

### CHECKING THE LOAD SENSE FILTERS

1. Locate the two piston pumps underneath the hopper. Locate the load sense port on each pump. The load sense port is the 3/8" size port coming out of the top of the pump.
2. Remove the hose from the fitting on the load sense port on the pump.
3. Remove the filter screen from the hose end. Hold the filter screen up to a light, and inspect it for debris. Replace the filters when over half of the filter appears to be blocked.
4. Slide the new filter screen into the hose end and reattach the hose to the fitting.

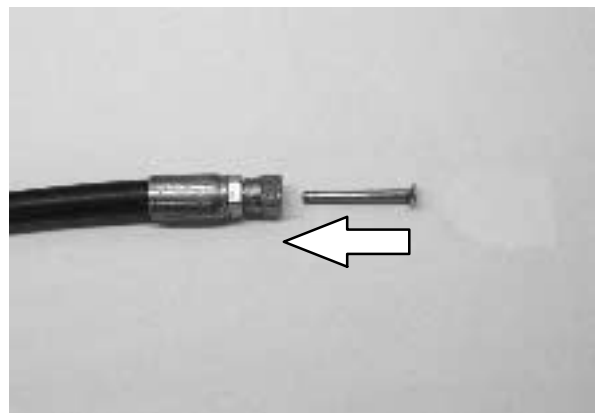
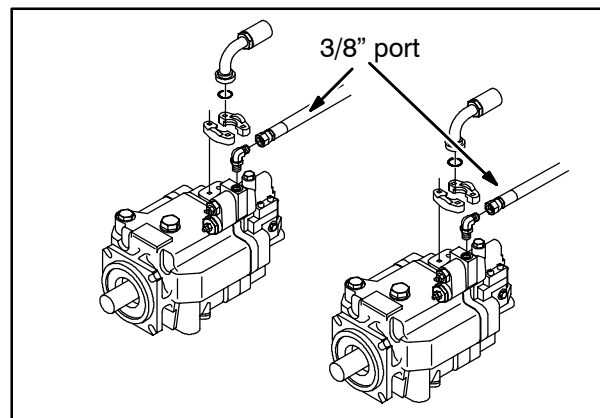

**HYDRAULIC FLUID FILTER**

The hydraulic fluid filter is located behind the top hydraulic cooler on the left hand side of the machine.

Replace the filter element after every 800 hours of operation.

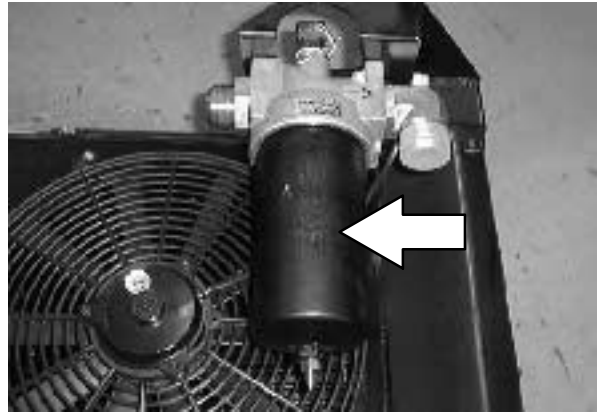

**HYDRAULIC COOLING SYSTEM**

Check the hydraulic cooler fins for debris daily. Blow or rinse all dust, which may have collected on the coolers, in the grille and radiator fins, from the opposite direction of normal air flow. Raise the debris hopper for easy access to the back side of the coolers. Be careful not to bend the cooling fins when cleaning. Clean thoroughly to prevent the fins becoming encrusted with dust. Clean the coolers only after they have cooled to avoid cracking.

**FOR SAFETY: When using pressurized air or water, wear eye and ear protection.**

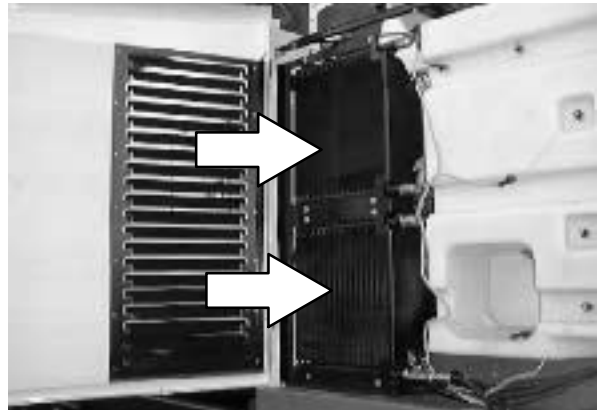

**HYDRAULIC HOSES**

Check the hydraulic hoses every 200 hours of operation for wear or damage.

Fluid escaping at high pressure from a very small hole can be almost invisible, and can cause serious injuries.

See a doctor at once if injury results from escaping hydraulic fluid. Serious infection or reaction can develop if proper medical treatment is not given immediately.

**FOR SAFETY: When servicing machine, use cardboard to locate leaking hydraulic fluid under pressure.**

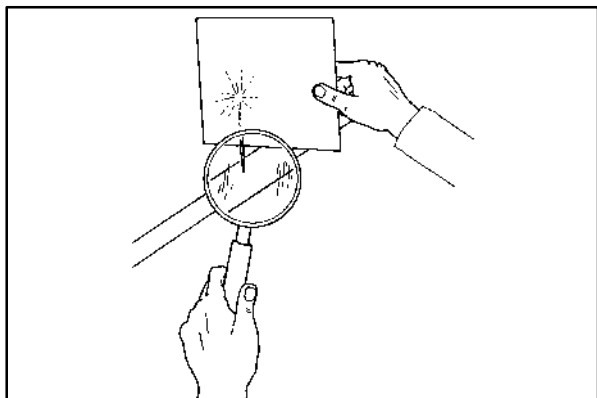

00002

If you discover a fluid leak, contact your mechanic/supervisor.

## ENGINE

---

**\*Refer to the maintenance schedule in the truck manufacturer's owner's manual.**

### ENGINE

Check the engine oil level daily. Change the engine oil and oil filter every 100 hours of operation.

### AIR FILTER RESTRICTION INDICATOR

The air filter restriction indicator is located behind the machine cab.

The air filter restriction indicator shows when to replace the air filter element. The yellow indicator will move as the air filter element fills with dirt. Do not replace the air filter element until the yellow indicator reaches the red ring in the sight glass. The indicator may return to a lower reading on the scale when the engine shuts off. The indicator will return to a correct reading after the engine runs for a while.

After the air filter is properly serviced, the indicator can be reset by pushing the button on top.

Check the air flow indicator daily.

**\*Refer to truck manufacturer's owner's manual.**



### ENGINE AIR CLEANER

The air cleaner is located behind the cab on the passenger's side of the machine.

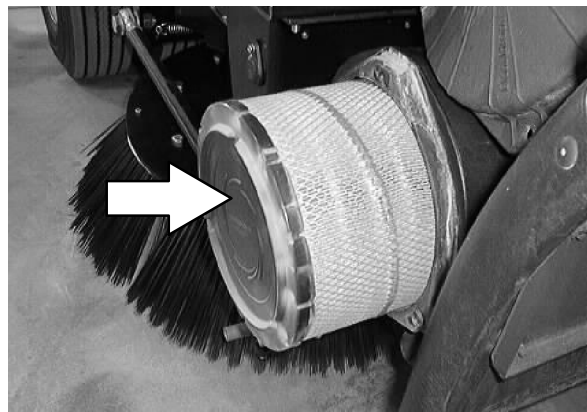

### ENGINE VALVES

The initial valve lash adjustment on new or rebuilt engines is required at the first 250 hours of operation. Allow the valves to cool before checking valves.

Refer to the maintenance schedule in the engine manufacturer's maintenance manual.



**TRANSMISSION**

**\*Refer to the maintenance schedule in the truck manufacturer's owner's manual.**

**TRANSMISSION ACCESS**

If the machine is equipped with the dry dust control (option), some of the skirts and panels will need to be removed to access the transmission filter.

**REMOVING DRY DUST CONTROL ASSEMBLY**

1. Drive the machine to an open work area. Allow plenty of room on both sides of the machine for removed parts.

*NOTE: An available grease or service pit would be preferred for this procedure.*

2. Check that the gutter brooms are turned off and in the raised position.
3. Turn the key counter-clockwise to stop the engine. Remove the switch key.

**FOR SAFETY: Before leaving or servicing machine, stop on level surface, and set parking brake.**



4. Remove the outer right and left side brush access panels (A) (if equipped).

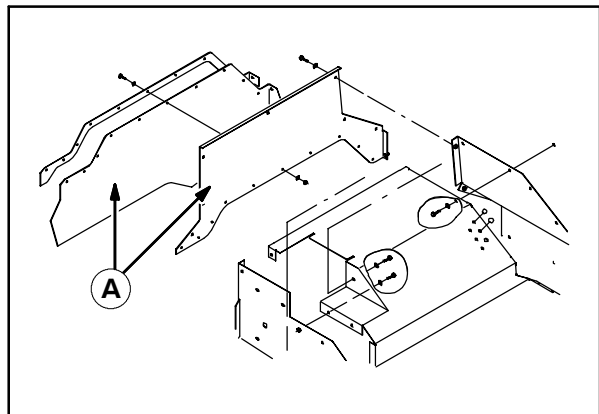

## MAINTENANCE

5. Remove the right and left brush shroud weldments (B) and hardware (if equipped).

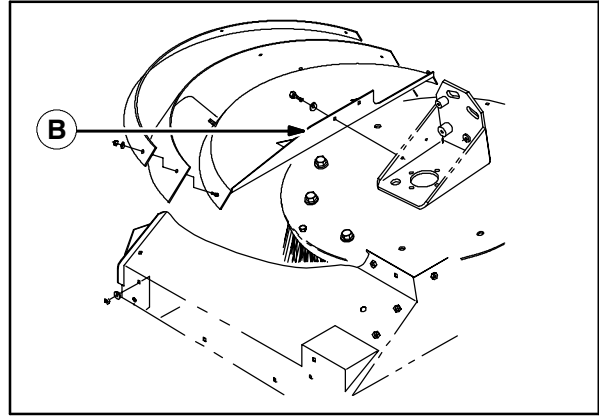

6. Remove the three bolts that attach the side brush assembly disc to the drive flange (C).

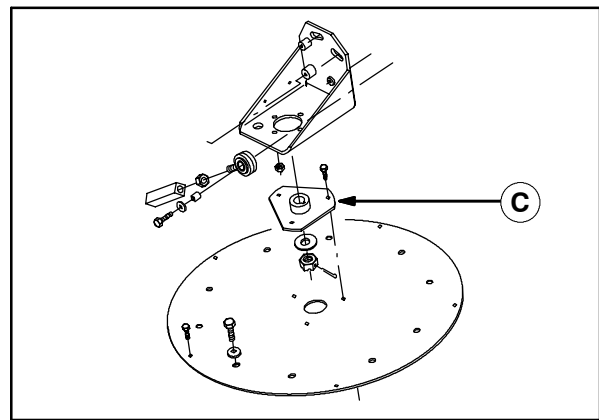

7. Remove the front skirt center lift shaft chain (D) hardware located on the rear side of the center skirt retainer.

8. Remove the upper front skirt retainer hardware. Remove the skirt as an assembly.

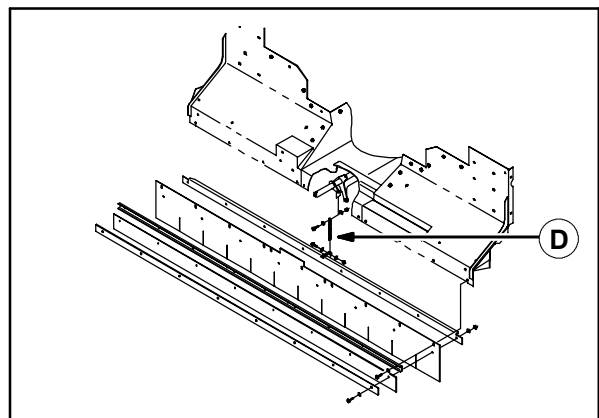

9. Remove the rear skirt upper retainer hardware (E).

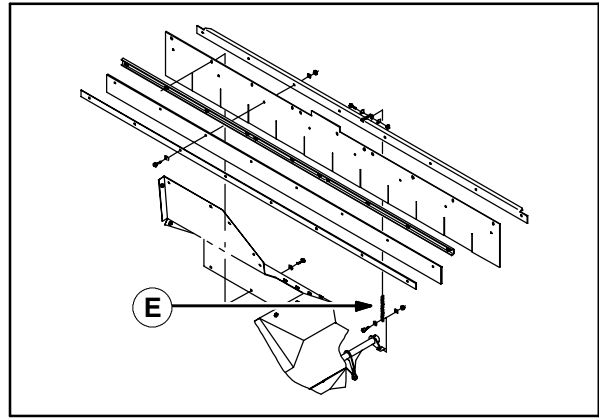

10. Locate both side brush skirt cables. Disconnect the clevis pins (F) from the center lift shaft and tie the cable ends up out of the way.

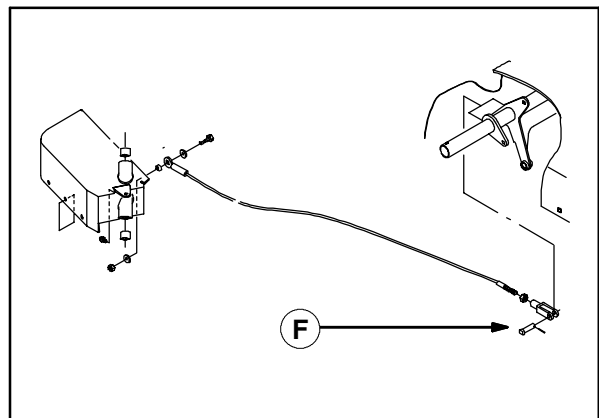

11. If the machine is equipped with the auto lube (option), disconnect the grease line fittings at the front and rear of the skirt lift shaft bearings.

12. Disconnect the front hydraulic skirt lift cylinder clevis pin (G) from the lift shaft.

13. Disconnect and retain the spring (H) next to the front lift cylinder clevis.

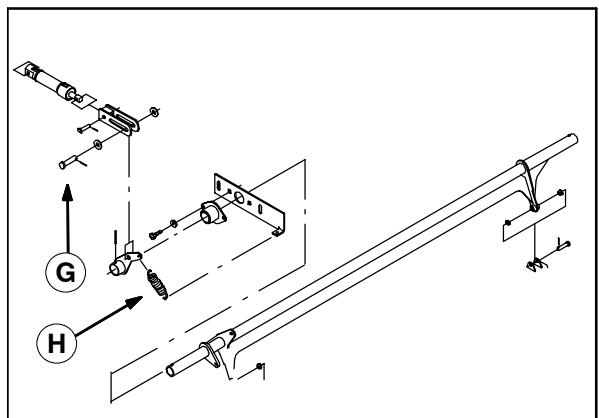

## MAINTENANCE

14. Locate and mark both the front and rear skirt lift shaft bearing mounts (I), and remove the bolts that hold the bearing and mount to the center shroud.

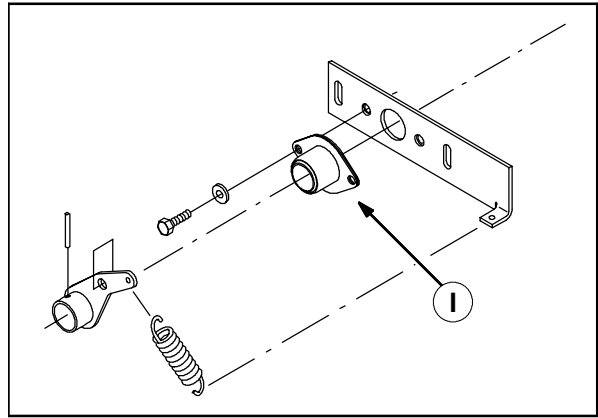

15. Remove the center skirt shaft deflector assembly.

16. Cut and or scrape off all of the RTV or silicone sealant that surrounds the seams of the center shroud where it attaches to the right and left shrouds.

17. Remove all of the hardware that attaches to the center shroud to the right and left shrouds.

18. Remove the center panel.

*NOTE: This may require two people to maneuver the shroud out of the way to access the transmission.*

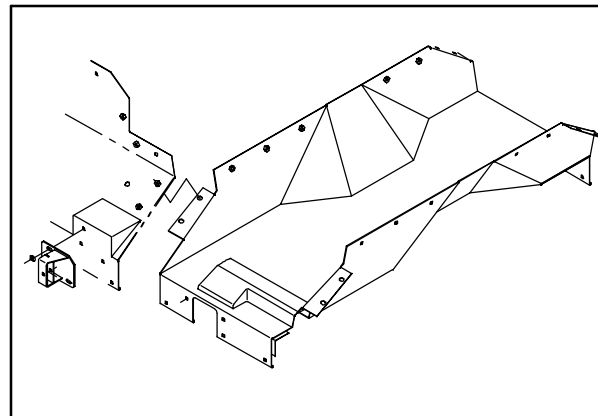

19. At this time, the transmission is now ready for service.

**NOTE: The recommended transmission fluid and filter change intervals are listed in the transmission and/or service section of the CD/manual.**

20. When service is complete, run engine and inspect the machine for any leaks before reassembling. Install center shroud and hardware, leaving the hardware loose until the entire assembly is installed. Tighten and re-seal the seams with clear silicone sealant. Use reverse order for reassembly.

**WET DUST CONTROL SYSTEM**

**WATER TANK**

The water tank for the wet dust control system is located in the rear of the machine.

Check the water tank for wear or damage after every 200 hours of machine operation.

Drain the water tank if the machine is going to be stored for long periods of time, or in freezing temperatures.

Check the water tank fill hose for wear or damage every 800 hours of machine operation.

**⚠ WARNING: Flammable materials can cause explosion or fire. Do not use flammable materials in tank. Only use water.**

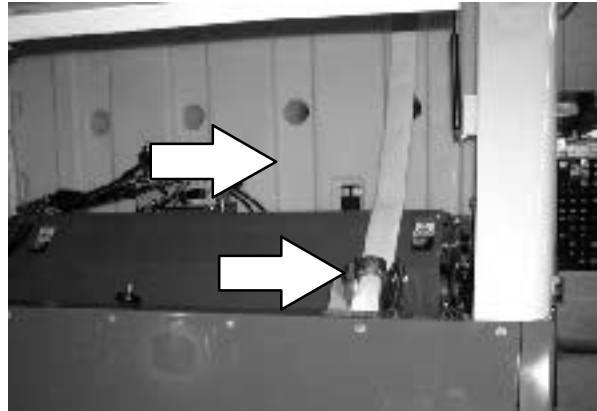

**WATER PUMP**

The water pump for the wet dust control system is located on the right hand side of the machine, next to the water filter.

Check the water pump for proper operation after every 200 hours of machine operation.

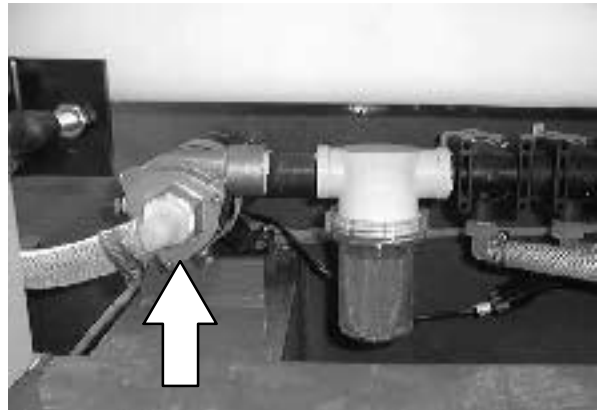

Drain the water pump if the machine is going to be stored for a long period of time, or in freezing temperatures.

Open the drain plug on the bottom of the water pump to drain any water out.

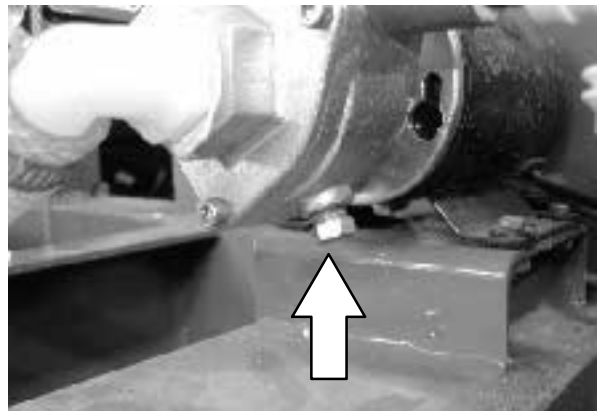

## MAINTENANCE

### WATER FILTER

The water filter is located on the right hand side of the machine, in front of the water pump.

Rinse the water filter clean after every 200 hours of machine operation.

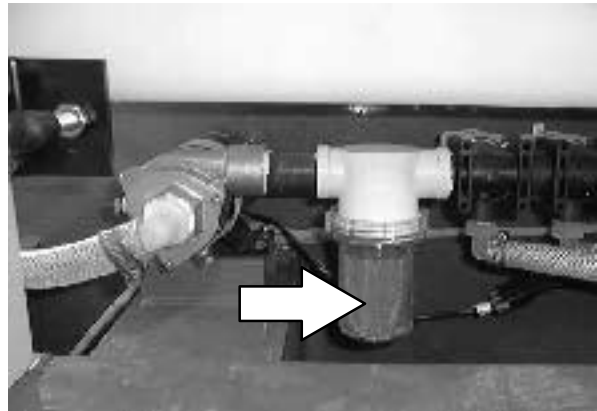

### WATER HOSES

Check the water hoses and clamps for tension, wear and damage every 800 hours of machine operation.

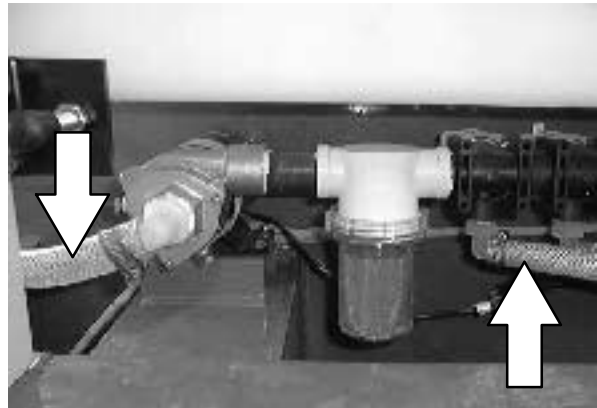

### SPRAY NOZZLES

The wet dust control system has four groups of standard spray nozzles with a fifth (optional) group for the optional left side gutter broom.

Check the spray nozzles daily for debris and adjustment. Spray the surrounding areas with a garden hose daily to help keep the spray nozzles clean.

**FOR SAFETY: When using pressurized air or water, wear eye and ear protection.**

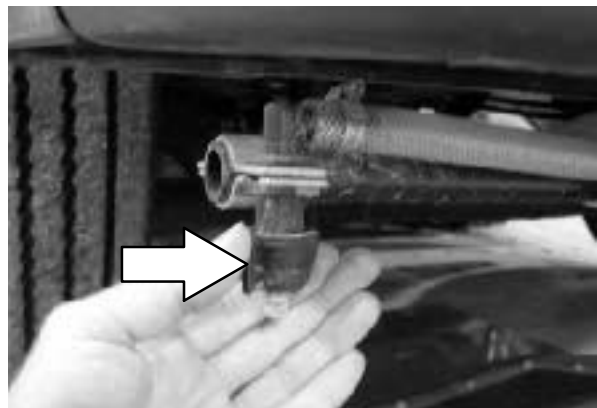

**DEBRIS HOPPER**

The debris hopper can hold up to 4 yards of debris. Check for any leftover debris each time after dumping the hopper. Check the hopper for wear or damage daily. Rinse the hopper out when washing the machine or as necessary.

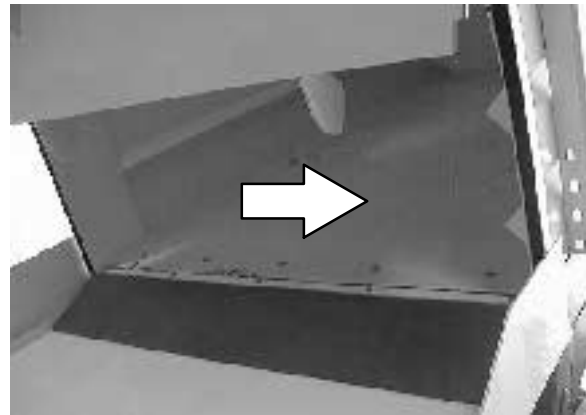

**THERMO SENTRY™**

The Thermo Sentry™ senses the temperature of the air pulled up from the hopper. If there is a fire in the hopper, the Thermo Sentry™ will stop all sweeping functions. The vacuum fan will turn off and the conveyor water spray will turn on to help extinguish any hopper fire. The Thermo Sentry™ is located on the top of the hopper next to the vacuum fan housing.

The Thermo Sentry™ will reset automatically when the temperature inside the hopper drops below 60° C (140° F).

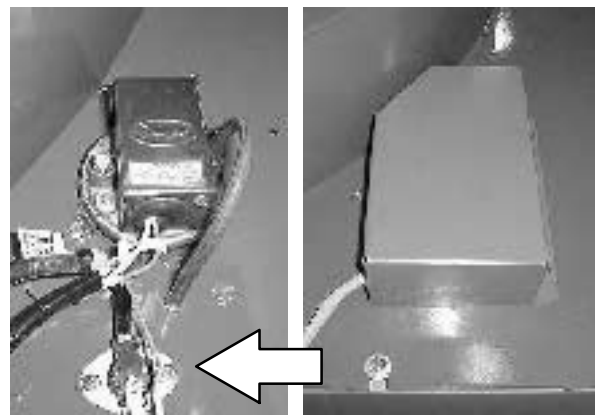

**HOPPER DUST FILTER**

The hopper dust filter filters the air pulled up from the hopper. The dust filter is equipped with a shaker to remove the accumulated dust particles. To clean the dust filter press the *filter shaker switch*.

Shake the dust filter before tilting or dumping the hopper and at the end of every work shift. When sweeping in dusty conditions, shake the filter more often.

The hopper dust filter can be washed by hand or rinsed with a low pressure water hose if the machine continues dusting, after shaking the dust filter.



## MAINTENANCE

### RINSING THE HOPPER DUST FILTER

1. Stop the engine and set the machine parking brake.

**FOR SAFETY: Before leaving or servicing machine, stop on level surface, set parking brake, turn off machine and remove key.**

2. Disconnect and remove the cover panels on each side of the vacuum fan assembly, on top of the debris hopper.
3. Rinse the filter using a low pressure water hose. Guide the hose up and down the horizontal rows of the dust filter, to rinse as much of the filter as possible.

*NOTE: Do not use a high pressure washer to clean the filter. It may tear or damage the filter media.*

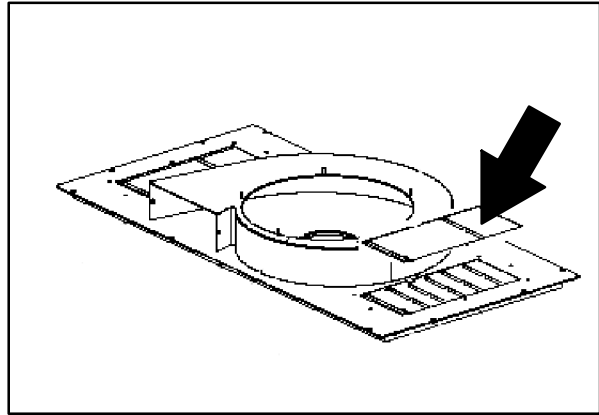

4. Replace the cover panels on each side of the vacuum fan.
5. Allow the hopper filter to dry completely before sweeping.

*NOTE: For faster drying, start the machine and allow the vacuum fan to run without sweeping.*

The hopper dust filter can also be removed from the machine and hand washed. See the TO REMOVE OR REPLACE HOPPER DUST FILTER section of the manual.





**TO REMOVE OR REPLACE HOPPER DUST FILTER**

1. Stop the engine and set the machine parking brake.

**FOR SAFETY: Before leaving or servicing machine, stop on level surface, set parking brake, turn off machine and remove key.**

2. Disconnect and cap the hydraulic hoses from the vacuum fan motor on top of the hopper.
3. Remove the vacuum fan assembly from the top of the hopper.
4. Remove the four retaining bars and support brackets holding the filter assembly in the hopper. Remove the old filter assembly.
5. Drill out the rivets holding the filter to the shaker frame. Untie the filter bag and remove the old filter bag from the frame.

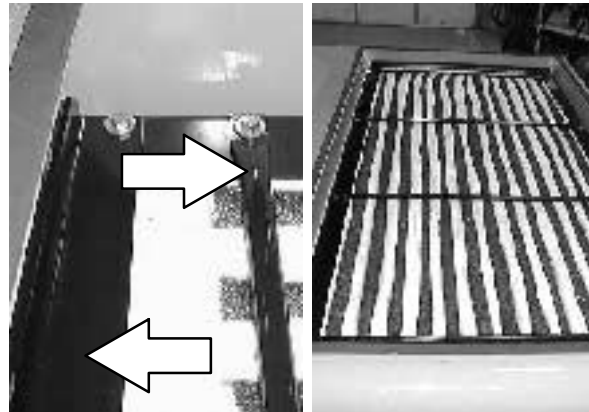

6. Install the new filter bag and filter separators in the frame.

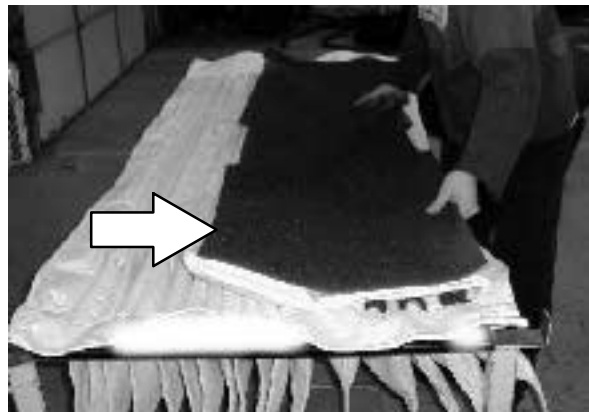

## MAINTENANCE

7. Rivet the new bag to the shaker frame. Tie the bag off.

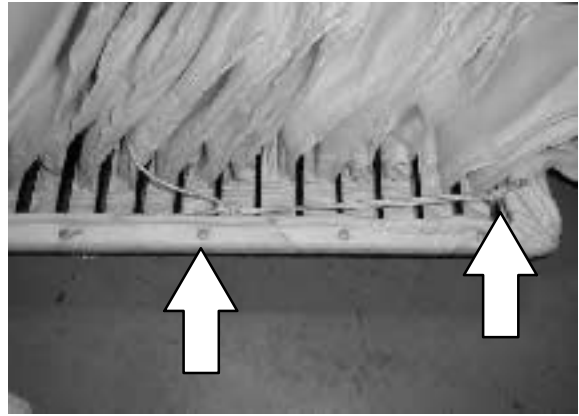

8. Place the rods in the new filter bag.

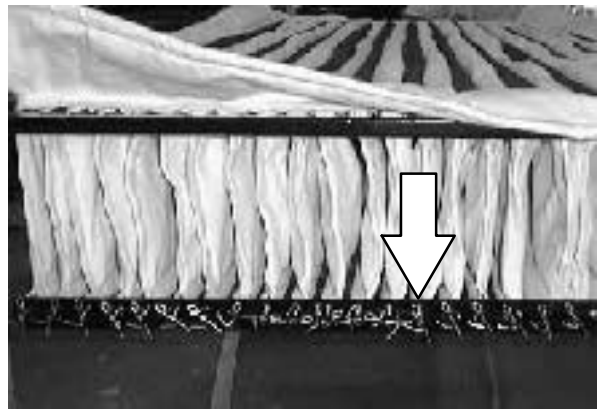

9. Install the filter assembly back in the machine. Secure the filter assembly with the support brackets and four retaining bars.

10. Replace the vacuum fan assembly on top of the machine.

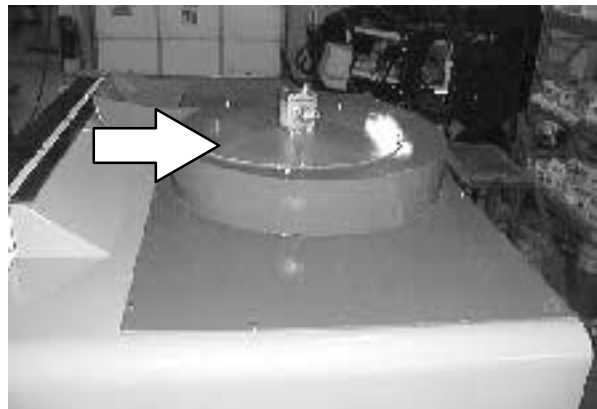

11. Reconnect the hydraulic hoses to the fan motor on top of the hopper.

**CONVEYOR**

The conveyor transports debris picked up by the main brush to the hopper, by means of a cleat system.

Lubricate the conveyor shaft bearings daily. See the LUBRICATION section of the manual.

Check the conveyor tension and tracking daily at the beginning of each shift.

Check the conveyor skirts and cleats for damage and wear daily.

**⚠ WARNING: Conveyor throws debris. Conveyor pinch point. Stay clear when in operation.**

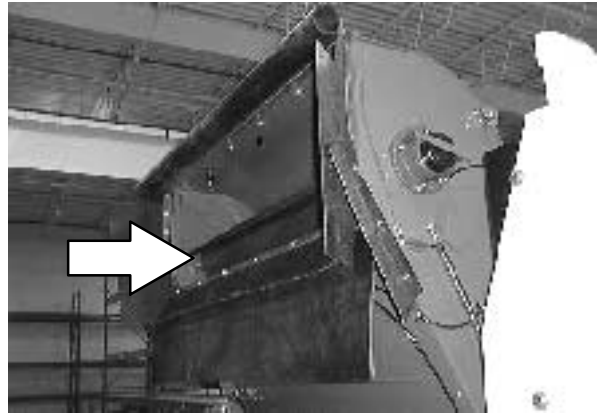

The conveyor height is factory set. When the machine is sweeping, the conveyor drag shoes should remain 25 to 38 mm (1 to 1.5 inches) off the ground.

Check the conveyor height after every 100 hours of machine operation.

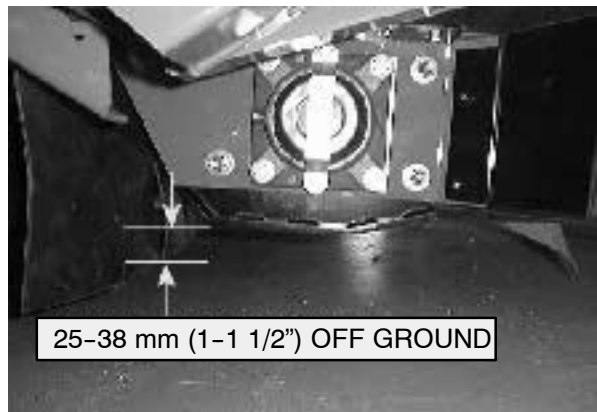

IF the conveyor drag shoes settle below the recommended 25 to 38 mm (1 to 1.5 inches), the height of the conveyor can be raised with the adjustment screws and jam nuts. See the ADJUSTING THE CONVEYOR HEIGHT section of the manual.



## MAINTENANCE

### ADJUSTING THE CONVEYOR HEIGHT

1. Start the machine. See the STARTING THE MACHINE section of the manual.
2. Activate the parking brake.

**FOR SAFETY: Before leaving or servicing machine, stop on level surface and set parking brake.**

3. Move the conveyor back away from the debris hopper.



4. Loosen the jam nut on each adjustment screw, on each side of the conveyor.
5. Turn each adjustment screw one or two full turns counterclockwise.

*NOTE: Turn each adjustment screw an equal number of turns.*

6. Lower the conveyor back into sweeping position and check the operating height of the conveyor.
7. If the conveyor is at the proper operating height, move the conveyor back away from the debris hopper and secure the adjustment screws with the jam nuts.
8. If the conveyor is still lower than recommended, continue adjusting the screws until the drag shoe is 25 to 38 mm (1 to 1.5 inches) from the ground.



The lower roller inside the conveyor can collect debris that occasionally falls off the conveyor belt. Flush the conveyor daily.

#### FLUSHING THE CONVEYOR BELT

1. Start the machine. See the STARTING THE MACHINE section of the manual.
2. Fill the water tank. See the FILLING THE WATER TANK section of the manual.
3. Open the water tank drain valve on the right hand side of the machine. The valve handle is in line with the hose when the valve is open.
4. Start the conveyor.
5. Allow the water to flush out the conveyor roller, until the water draining from the conveyor is clean.
6. Close the water tank drain valve. The valve handle is turned 90° from the hose when the valve is closed.
7. Turn the conveyor off.

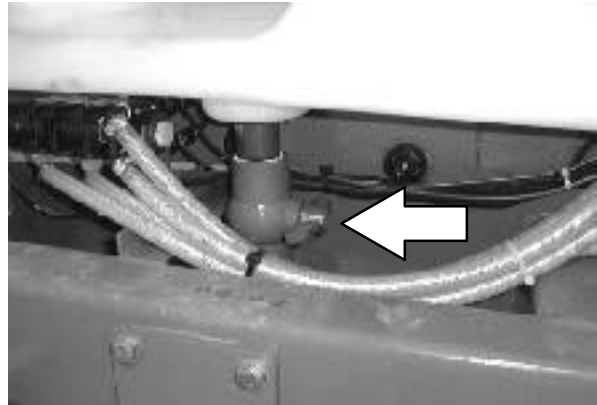

## MAINTENANCE

The tracking on the original conveyor belt is factory set. The conveyor belt should track in the middle of the top roller with at least a half inch of roller visible on either side of the conveyor belt. (The conveyor belt can track slightly off to one side or another, as long as the belt is not wobbling extremely back and forth across the top roller). If the conveyor belt is wobbling or tracking less than 13 mm (0.5 in) from the right or left edge of the roller, the tracking should be adjusted. Check the tracking for the conveyor belt daily.

### TO ADJUST THE CONVEYOR BELT TRACKING

1. Start the machine. See the STARTING THE MACHINE section of the manual.
2. Start the conveyor.

3. Watch the conveyor belt track, and determine which side of the roller needs to be raised or lowered.

4. Stop the conveyor.

5. Loosen the jam nut on the tension rod. Adjust the tension rod with the adjustment nut, next to the washers.

**⚠ WARNING: Conveyor throws debris. Conveyor pinch point. Stay clear when in operation.**

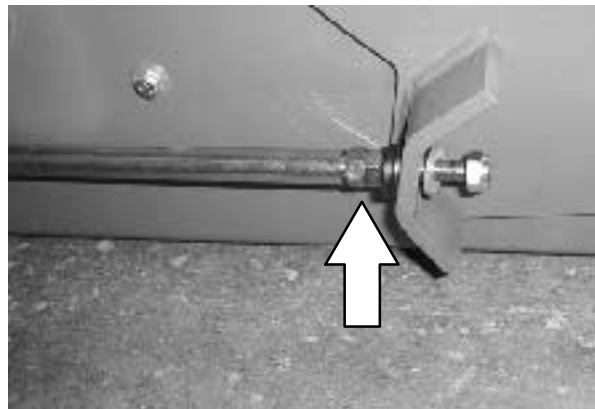
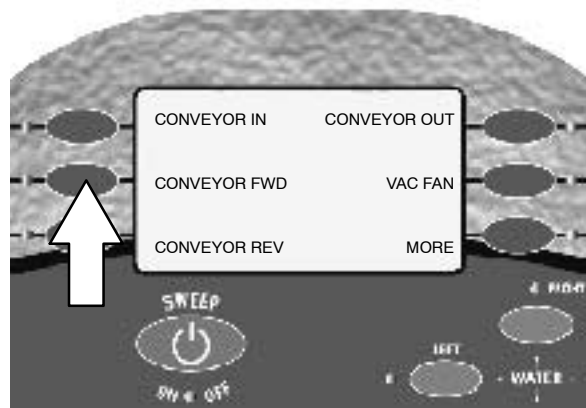

6. Raise or lower the ends of the roller until the conveyor belt tracks in the center of the roller.

*NOTE: It is easier to lower (shorten) the end you want the belt to move towards, than raising the opposite end.*

*Always attempt to lower (shorten) the end you want the belt to move towards, until the nuts bottom against the adjusting rod shoulders.*

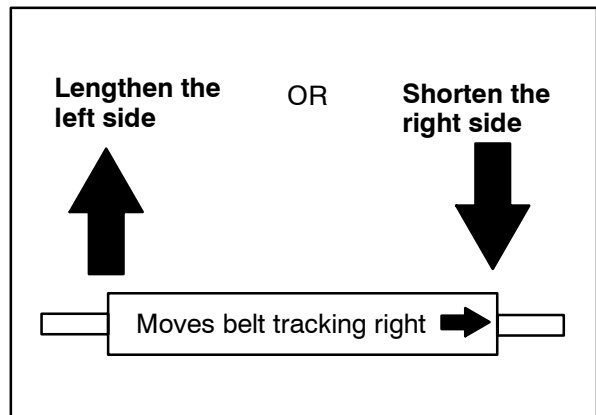
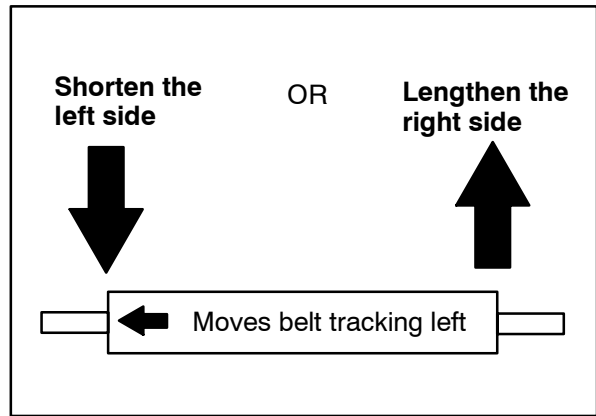

7. Secure the adjustment nut with the jam nut. **DO NOT TIGHTEN DOWN THE LOC NUT ON THE END OF THE TENSION ROD.**
8. Check that the belt tension springs are both compressed to a length of 178 to 190 mm (7 to 7.5 inches).
9. Run the conveyor at slow speed and check the tracking of the conveyor belt. Adjust the belt as necessary.

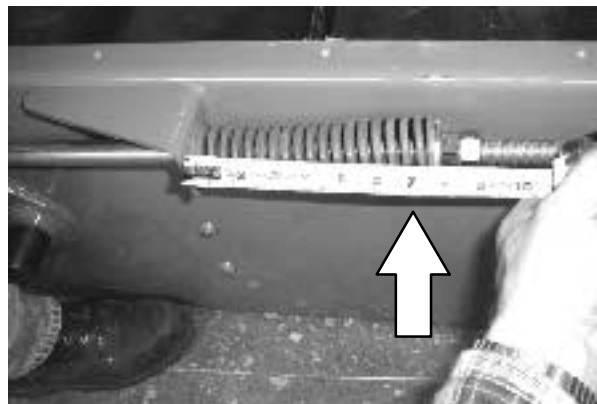

## MAINTENANCE

---

Check the conveyor skirts and cleats for damage and wear daily. If the conveyor belt becomes excessively worn or damaged, it will need to be replaced.

### TO REPLACE THE CONVEYOR BELT

1. Remove the main brush. See the TO REPLACE THE MAIN BRUSH section of the manual.
2. Start the machine. See the STARTING THE MACHINE section of the manual.
3. Move the splice of the old conveyor into position right above the lower conveyor roller.

 **WARNING: Conveyor throws debris. Conveyor pinch point. Stay clear when in operation.**

4. Open the main hopper door.
5. Turn the key counter-clockwise to stop the engine. Remove the switch key.

**FOR SAFETY: Before leaving or servicing machine, stop on level surface, set parking brake, turn off machine and remove key.**

6. Loosen the nuts under the blue “die” springs on the sides of the conveyor to release the tension on the conveyor belt. Loosen the jam nut and move the second nut back to the ends of the threads on the tension rod.

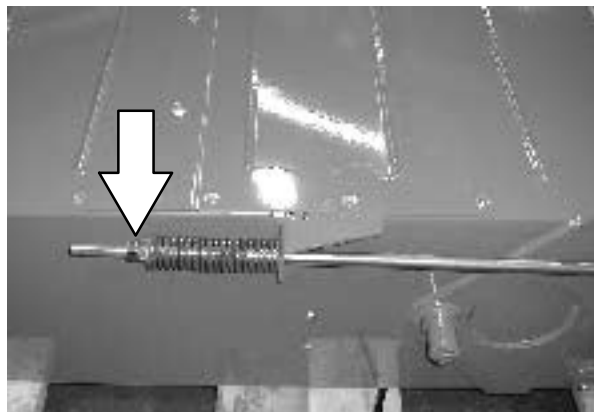



7. Separate the two ends of the conveyor belt at the splice. This can be done by unbolting the entire splice. If the old belt is going to be replaced with a new belt, you can cut the old belt crossways, just above the splice, with a utility knife. (One end of the old conveyor belt will be spliced with one end of the new conveyor belt. The old belt will be used to help pull the new conveyor belt into position over the top roller).

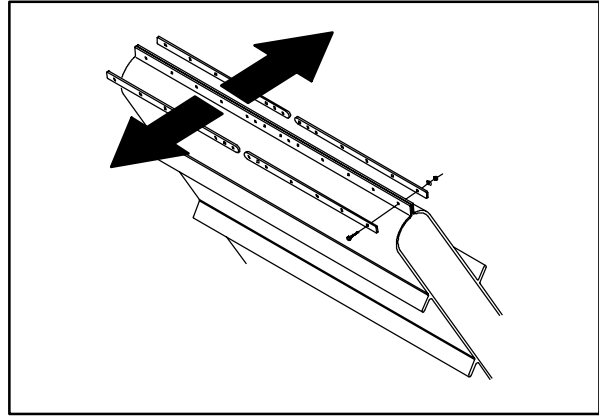

8. Inspect the lower roller area and the flushing fitting for build up of debris. Adjust the scraper if necessary. It should be parallel to and 3mm (0.125 in) away from the lower roller.

9. Position the new belt inside the brush compartment, so the new belt is in the same orientation as the old belt.

10. Splice two ends of the belts together, placing the end of the old belt on the bottom, and new belt on top. Use three bolts positioned uniformly across the width of the belts to splice the ends together.

11. Carefully climb into the debris hopper and pull up on the edges of the old belt, to pull the new belt in to the conveyor. Stop when the last edge of the new belt is even with the lower roller.

*NOTE: Pulling the new conveyor belt into position is easier when done with two people.*

12. Disconnect the splice between the new and old belts. Remove and discard the old conveyor belt.

13. Check that the belt is in the approximate center of the conveyor. Draw the ends of the conveyor belt together.

## MAINTENANCE

14. Connect the ends of the new belt together with the new hardware. Check that the bolts will be running up the conveyor 'head first' when the conveyor is running normally, followed by the nuts. Tighten all the splice nuts until they are snug. The ends of the belt should extrude slightly between the splice plates.

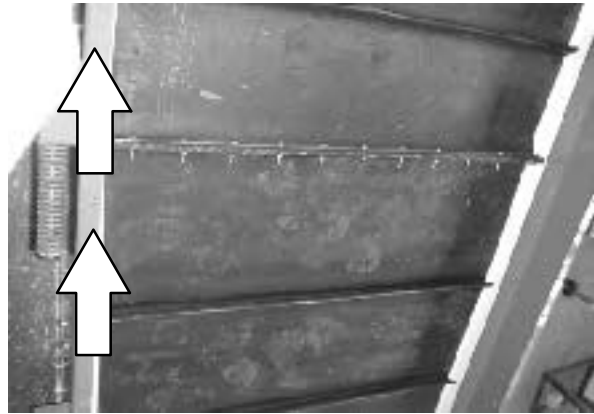

15. Adjust the belt tension springs until they are both compressed to a length of 178 mm (7 inches).

16. Run the conveyor at slow speed and check the tracking of the new conveyor belt. Adjust the new belt as necessary. See the TO ADJUST THE CONVEYOR BELT TRACKING section of the manual.

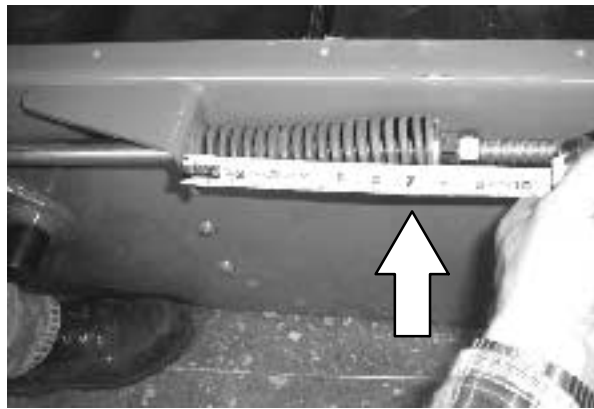

17. Reassemble the brush drive, shrouds and skids. See the TO REPLACE THE MAIN BRUSH section of the manual.

18. Over the next ten hours of operation, check the tension spring length and belt tracking periodically. The spring tension should be maintained at 178 to 190 mm (7 to 7.5 inches).

**BRUSHES**

**MAIN BRUSH**

The main brush is cylindrical and spans the width of the machine, sweeping debris into the conveyor, which deposits the debris into the hopper.

Check the brush daily for wear or damage. Remove any string or wire tangled on the main brush, main brush drive hub, or main brush idler hub.

Check the main brush pattern for taper daily. Adjust the main brush pattern with the brush lift cables.

Replace the main brush when the remaining bristles measure 125 mm (5 in) in length or when the brush measures 457 mm(18 in) in diameter.

**TO REPLACE THE MAIN BRUSH**

1. Park the machine on level ground and set the machine parking brake.
  
2. Open the rear machine door. Locate the brush bar next the hydraulic cylinder on the left hand side of the machine.

**⚠ WARNING: Brush linkage pinch points. Stay clear when linkage is moving.**

3. Secure the brush bar to the end of the cylinder with the washer and cotter pin. Press the sweep switch and lower the main broom until the cylinder cannot extend any further.
  
4. Stop the engine with the sweep switch still in the on position.

**FOR SAFETY: Before leaving or servicing machine, stop on level surface, set parking brake, turn off machine and remove key.**

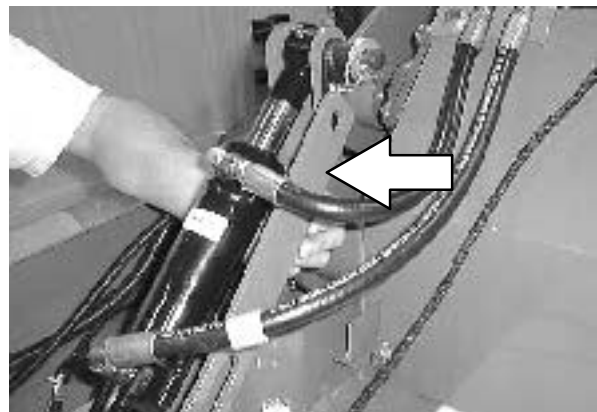

## MAINTENANCE

5. Remove the cover panel from the right hand side of the machine. Set the nuts and washers aside.

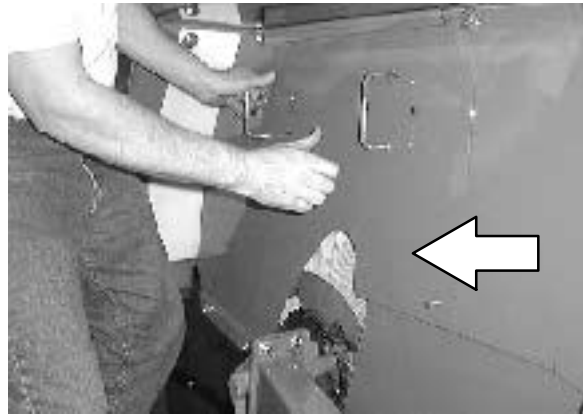

6. Disconnect and remove the rear section of the idler arm from the main brush and the lift arm. Disconnect and remove the drag shoe assembly from the right hand side of the truck.

*NOTE: Note the location of the mounting fasteners before disassembly. The drag shoes should be reassembled in the same position on marked locations after the new broom has been installed.*



7. Remove the old brush from the machine.

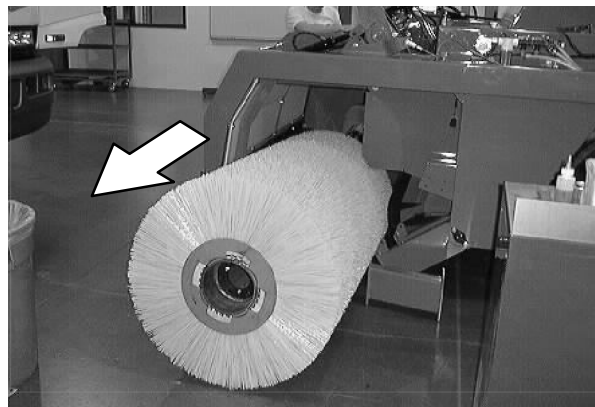

8. Push the new sweeping brush into mounting position on the drive hub. Rotate the brush as it is pushed onto the drive hub, so the bristles will keep the brush up at the proper height.

*NOTE: Open the cardboard shipping container and lay it flat on the ground, to help slide the new broom into mounting position.*

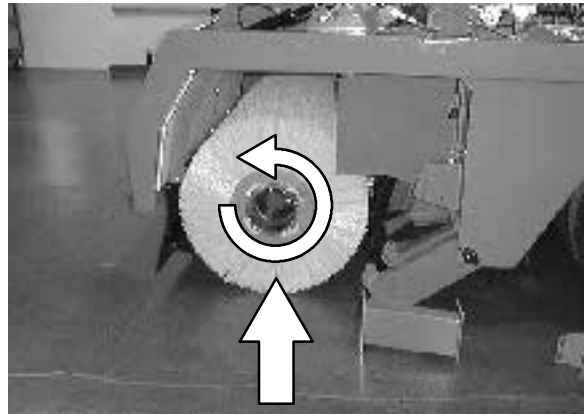

9. Reinstall the drag shoe assembly with set aside hardware. Align the notches chiseled into each flange. Check that flanges are square to each other, before tightening fixture.



10. Reinstall the brush idler arm with the set aside mounting hardware. Check that the brush idler arm shaft is in line with the broom before tightening hardware.

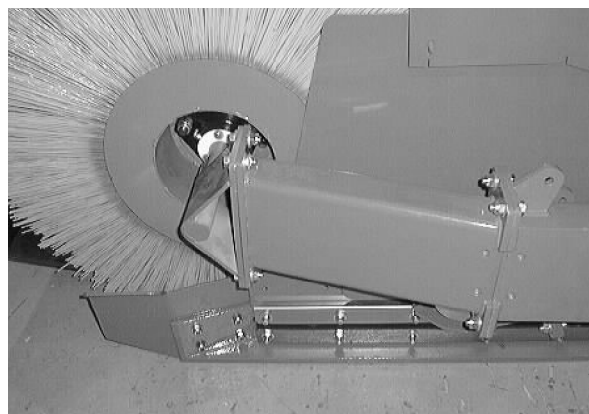

## MAINTENANCE

11. Tighten the lift arm mounting hardware to 70–84 Nm (50–60 ft lb).

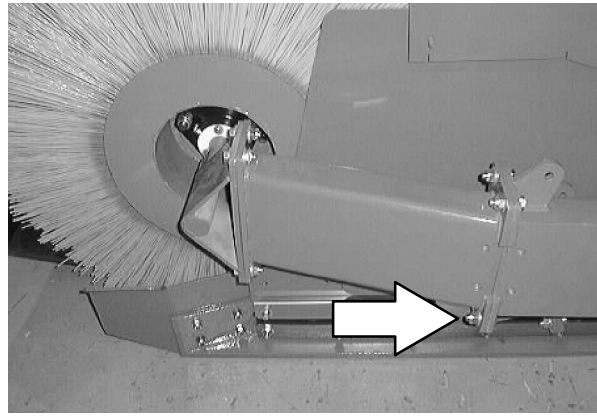

12. Replace the right hand panel and secure with set aside nuts and washers. Tighten mounting hardware to 35–50 Nm (25–35 ft lb).



13. Start the machine. See the STARTING THE MACHINE section of the manual. Raise the main broom.

14. Raise the main broom.

15. Disconnect the brush bar from the hydraulic lift cylinder. Lower the brush bar down into storage position.

16. Close the rear door on the machine.

17. Check and adjust the main brush pattern if necessary.

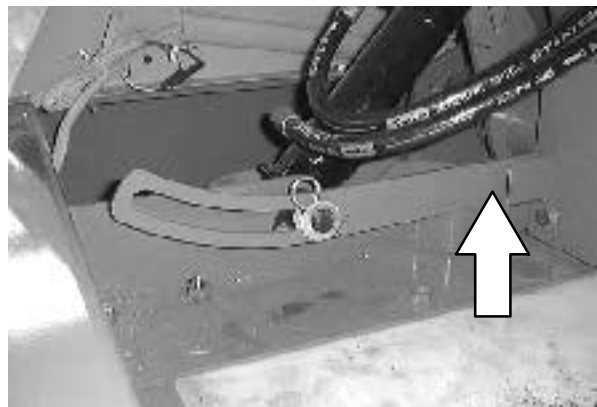

**TO CHECK AND ADJUST MAIN BRUSH PATTERN**

1. Park the machine on level ground and set the machine parking brake.
2. Press the *sweep switch* to lower and start the main brush. Allow the brush to rotate in one place for 2 minutes at the NORMAL main broom pressure setting.



3. Press the *sweep switch* again to raise and stop the main brush.
4. Drive the machine off the test area.
5. Observe the width of the brush pattern. The proper brush pattern should have parrallel sides with no taper in the pattern.

**NOTE: DO NOT ADJUST THE LIFT CABLES TO RAISE THE BRUSH. LOWER THE BRUSH ONLY.**

6. If there is a taper in the pattern, adjust the lift cables to increase the width of the narrow end of the brush pattern. Check that cables have equal tension on both sides of the machine.
7. Check the brush pattern again if necessary. Secure the lift cable adjusting hardware.

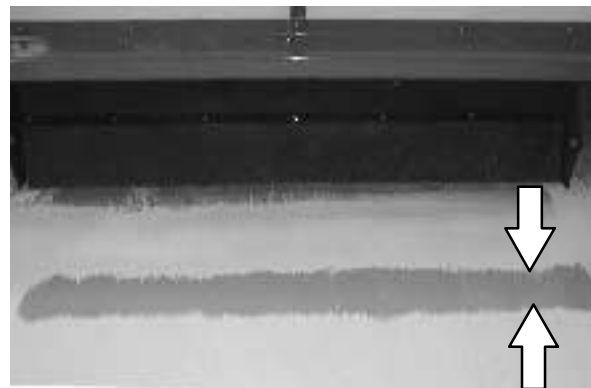

## MAINTENANCE

### GUTTER BROOM(S)

The gutter broom sweeps debris along edges into the path of the main brush.

**WARNING:** Brush linkage pinch points. Stay clear when linkage is moving.

Check the gutter broom daily for wear or damage. Remove any string or wire found tangled on the gutter broom or gutter broom drive hub.



The gutter broom pattern is set at the factory and should be checked periodically. The right side gutter broom bristles should contact the floor in a 10 o'clock to 4 o'clock pattern when the broom is in motion, creating a sweeping path 90–100 mm (36–40 in) wide. The left side gutter broom (option) should contact the floor in a 8 o'clock to 2 o'clock pattern when the broom is in motion.

The gutter broom(s) should be replaced when it no longer sweeps effectively for your application. A guideline length is when the remaining bristles measure 75 mm (3 in) in length. You may change the gutter broom sooner if you are sweeping light litter, or wear the bristles shorter if you are sweeping heavy debris.

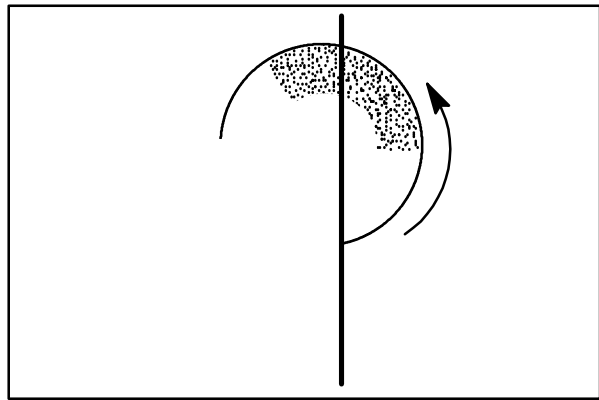

03376

### TO REPLACE THE GUTTER BROOM(S)

1. Raise and stop the gutter broom(s).
2. Stop the engine and set the machine parking brake.

**FOR SAFETY: Before leaving or servicing machine, stop on level surface, set parking brake, turn off machine and remove key.**

3. Remove the dust control skirt (option) if equipped.
4. Remove the gutter broom retaining hardware holding the gutter broom to the drive hub.

**WARNING:** Side brush can move. Do not step on side brush.

5. Mount the new gutter broom to the drive hub with the set aside mounting hardware.



**TO CHECK AND ADJUST THE GUTTER BROOM PATTERN**

1. Park the machine on level ground and set the machine parking brake.

**FOR SAFETY: Before leaving or servicing machine, stop on level surface, and set parking brake.**

2. Press the *gutter broom switch(es)* to lower and start the gutter broom(s). Allow the gutter broom(s) to rotate in one place for 2 minutes.

**⚠ WARNING: Side brush can move. Do not step on side brush.**

3. Press the *gutter broom switch(es)* again to raise and stop the gutter brooms.

4. Drive the machine off the test area.

5. Observe the gutter broom pattern(s). The right side gutter broom bristles should contact the floor in a 10 o'clock to 4 o'clock pattern when the broom is in motion, creating a sweeping path 90-100 mm (36-40 in) wide. The left side gutter broom (option) should contact the floor in a 8 o'clock to 2 o'clock pattern when the broom is in motion.

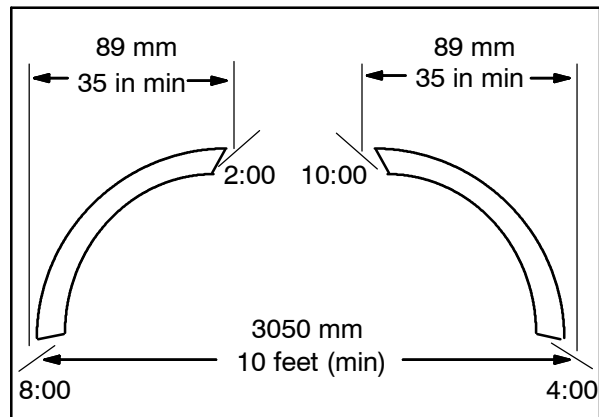
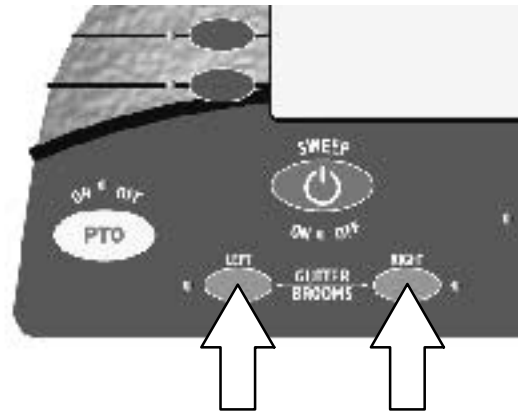

If the gutter broom(s) forward/aft tilt is incorrect, adjust the gutter broom forward and aft tilt with the adjustment bar:

6. Loosen the jam nuts on both ends of the adjustment bar.

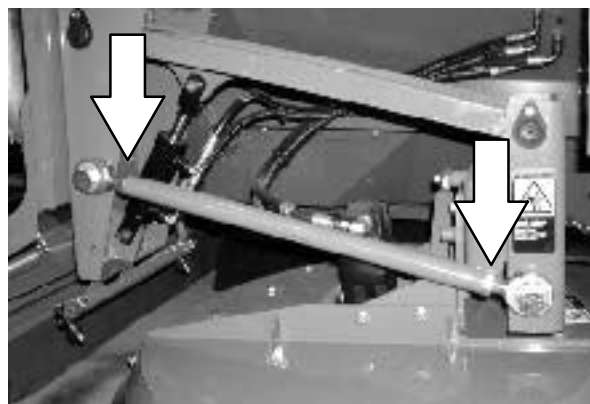

## MAINTENANCE

7. Rotate the adjustment bar clockwise or counterclockwise to decrease or increase the forward/aft tilt angle.
8. Tighten the jam nuts on both ends of the adjustment bar.

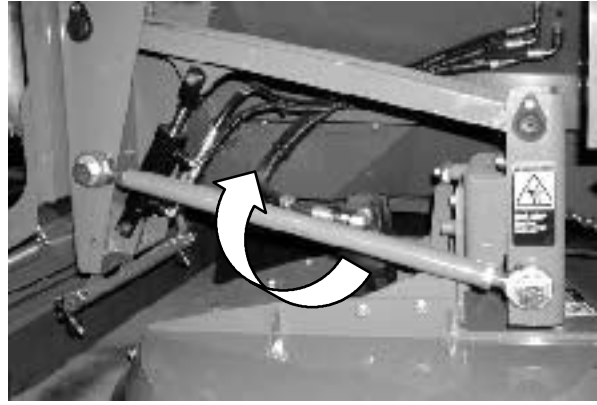

If the gutter broom(s) side to side adjustment is incorrect, adjust the side to side tilt with the square adjustment bar:

9. Loosen the motor mount securing screw and the jam nut on the end of the square adjustment bar.

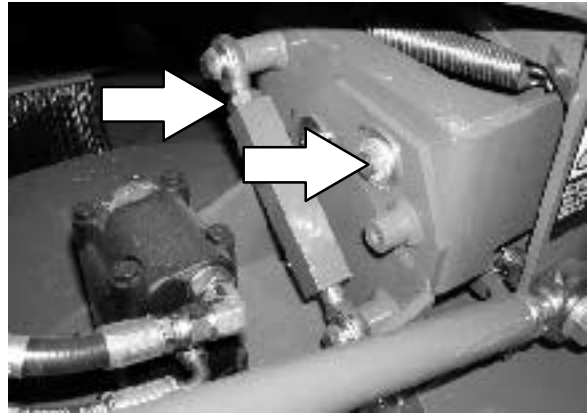

10. Rotate the square adjustment bar clockwise or counterclockwise to decrease or increase the side to side angle of tilt.

11. Tighten the jam nut on the end of the square adjustment bar and the motor mount securing screw.

12. Check the gutter broom pattern again if necessary. Check that all of the adjustment bar jam nuts are secure.

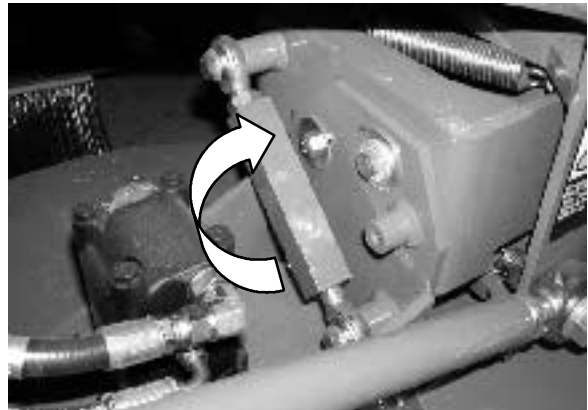

**SKIRTS AND SEALS**

**BRUSH COMPARTMENT SIDE SKIRT**

The brush compartment skirt is located at the rear of the brush compartment. The skirt should clear the ground by 3 mm (0.125 in).

Check the skirt for wear or damage daily.

**⚠ WARNING: Brush linkage pinch points. Stay clear when linkage is moving.**



**BRUSH COMPARTMENT REAR SKIRT**

The brush compartment skirt is located at the rear of the brush compartment. The skirt should clear the ground by 3 mm (0.125 in).

Check the skirt for wear or damage daily.

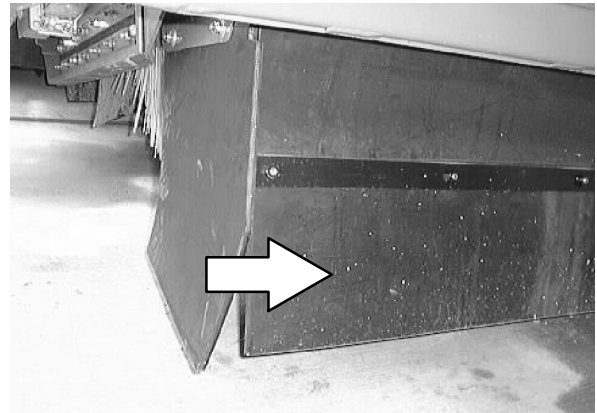

**TOP CONVEYOR SKIRTS**

The conveyor has a lip skirt located at the top of the conveyor and two side skirts on each side of the conveyor. The top conveyor side skirts should overlap the hopper skirts about 12.7 mm (0.5 in) when the conveyor is lowered into the sweeping position.

Check the skirts for wear or damage and proper fit daily.

**⚠ WARNING: Conveyor throws debris. Conveyor pinch point. Stay clear when in operation.**

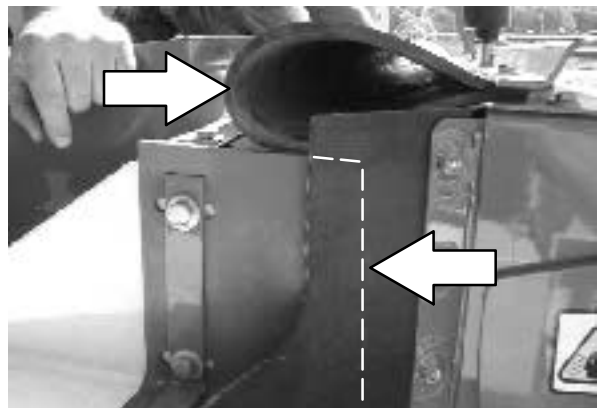

## MAINTENANCE

### BOTTOM CONVEYOR SKIRTS

The conveyor has a rear skirt located at the bottom of the conveyor and a side skirt on each side of the conveyor.

Check the skirts for wear or damage daily.



**WARNING: Conveyor throws debris. Conveyor pinch point. Stay clear when in operation.**

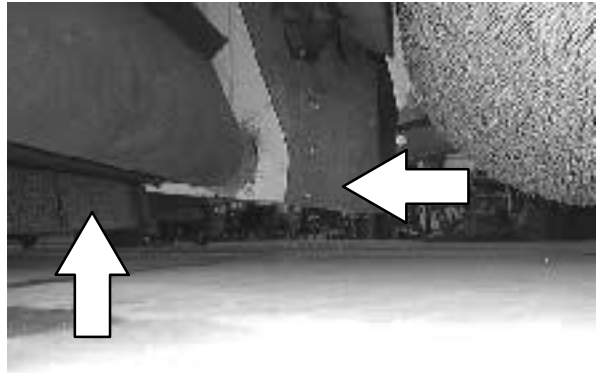

### HOPPER CHUTE DOOR SKIRT

The hopper chute door has a skirt located along the bottom of the door opening.

Check the skirt for wear or damage every 100 hours of operation.

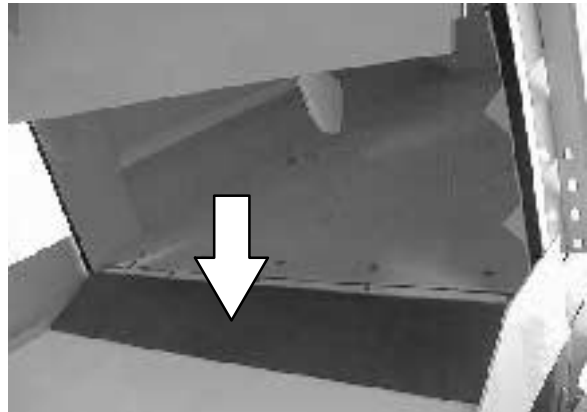

### HOPPER CHUTE DOOR SEALS

The hopper chute door seals are located on the sides of the hopper, and seal against the hopper chute door when it is closed.

Check the seals for wear or damage every 100 hours of operation.

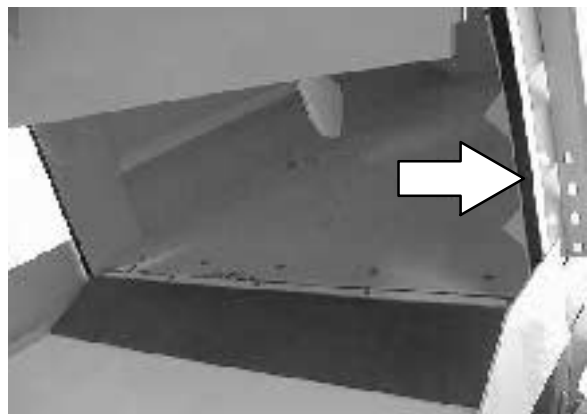

**HOPPER ACCESS DOOR SEAL**

The hopper access door seal is located around the hopper access door opening on the left hand side of the machine

Check the seal for wear or damage every 100 hours of operation.

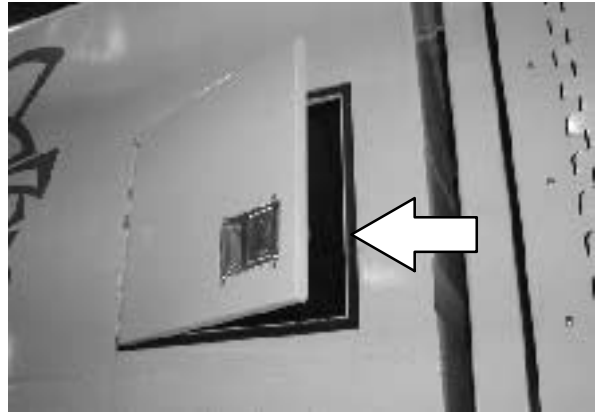
**HOPPER FILTER COVER SEAL**

The hopper filter cover seal is located around the outside edge of the dry dust control filter (option). It seals the vacuum fan assembly to the top of the hopper.

Check the seal for wear or damage every time the dust filter is cleaned or replaced.

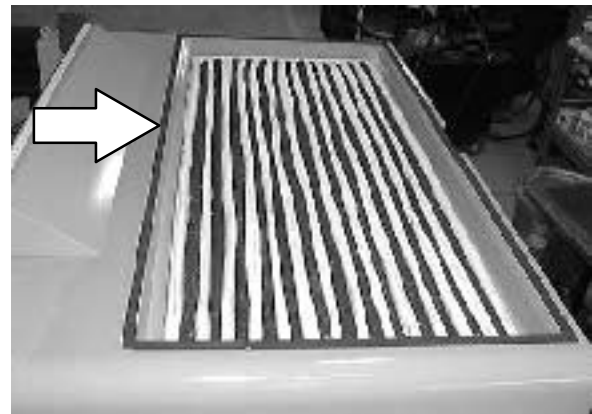
**VACUUM DUCT SEALS (OPTION)**

The vacuum duct seals are located on the top and bottom of the middle section of ductwork for the dry dust control option.

Check the seals for wear or damage every 100 hours of operation.

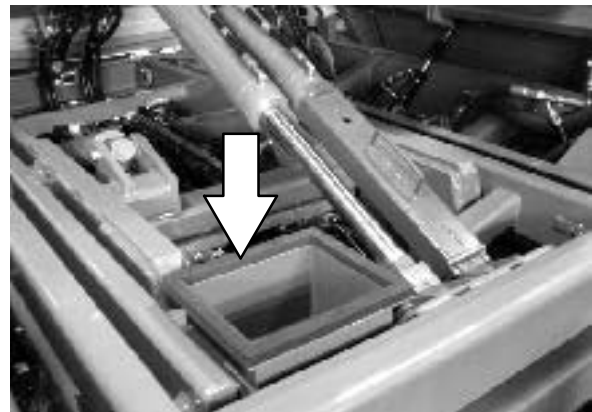

## MAINTENANCE

### ACCESS PANEL DUST SKIRTS (OPTION)

The dry dust control (option) has dust skirts over the right side gutter broom and the left side gutter broom (option).

Check the skirts for wear or damage every 100 hours of operation.

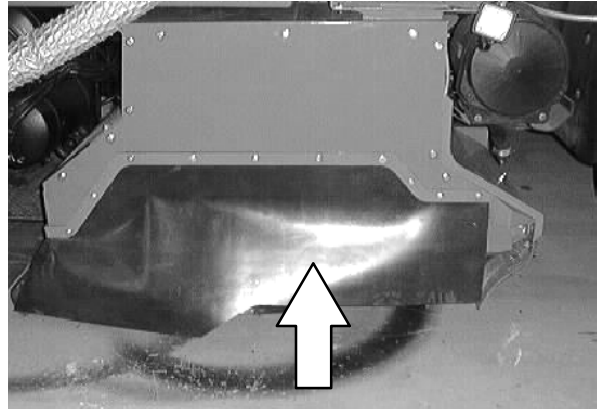

### FRONT DRY DUST CONTROL SKIRTS (OPTION)

The front dry dust control (option) skirts are mounted to the front of the dry dust control housing.

Check the skirts for wear or damage every 100 hours of operation.

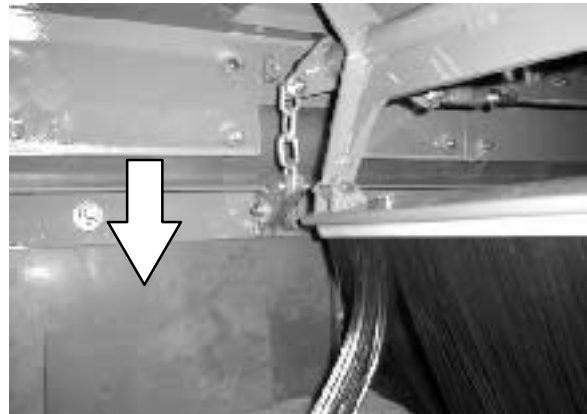

### CENTER DRY DUST CONTROL SKIRT (OPTION)

The center dust control (option) skirt hangs in the middle of the dry dust control housing, in between the right gutter broom and left gutter broom (option).

Check the skirt for wear or damage every 100 hours of operation.

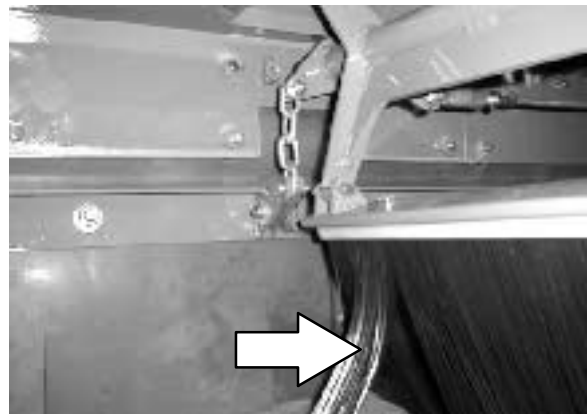

**REAR DRY DUST CONTROL SKIRTS (OPTION)**

The rear dry dust control (option) skirts are mounted in the rear of the dry dust control housing.

Check the skirts for wear or damage every 100 hours of operation.

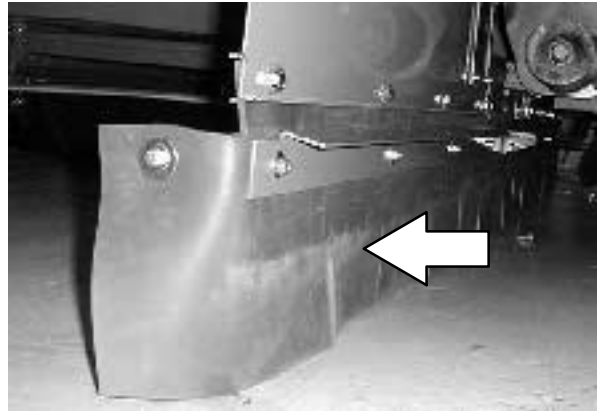

**DRY DUST CONTROL WING SKIRTS (OPTION)**

The dry dust control (option) wing skirts are mounted in the front corners of the dry dust control housing.

Check the skirts for wear or damage every 100 hours of operation.

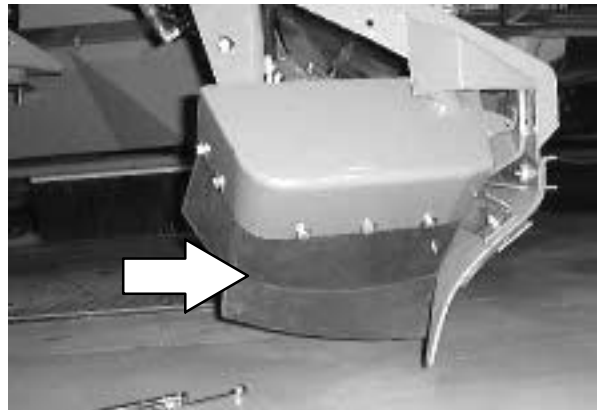

**DRY DUST CONTROL GUTTER BROOM SKIRT(S) (OPTION)**

The dry dust control (option) gutter broom skirt(s) are mounted on the outside of the right gutter broom and left gutter broom (option).

Check the skirts for wear or damage every 100 hours of operation.

**WARNING:** Brush linkage pinch points. Stay clear when linkage is moving.

**WARNING:** Side brush can move. Do not step on side brush.

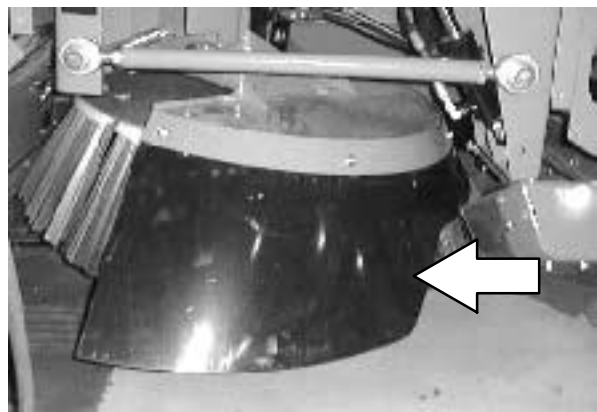

### DRAG SHOES

The drag shoes are located on either side of the brush compartment. They skim the ground when the conveyor is lowered into the sweeping position and are designed to contain debris between the main brush and the conveyor lip.

Check the drag shoes for wear after every 100 hours of operation. The drag shoes should be replaced when the thickness is less than 3 mm (0.125 in).

The drag shoes are attached to the upper plate by means of a rubber flap which absorbs shock. Check the rubber flaps every 100 hours of operation for damage or wear.

The drag shoe pivots are located on both sides of the machine, just inside the main brush lift arms. Check the drag shoes for slack every 50 hours of operation.

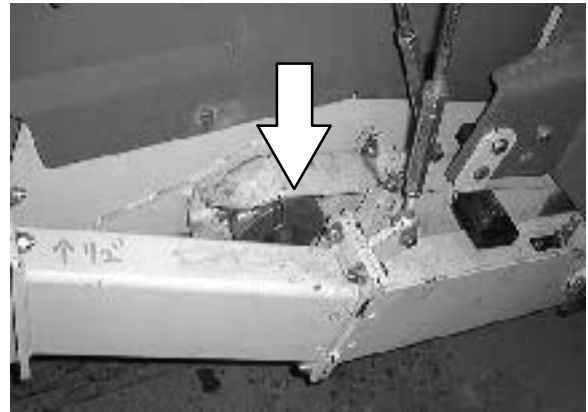
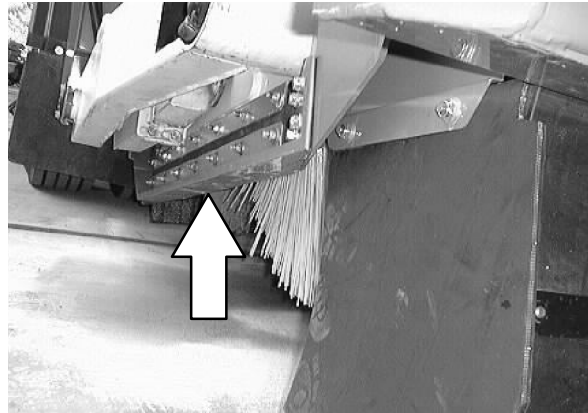



---

## MACHINE JACKING

---

You can jack up the machine for service at the designated locations under the axle. Use a Hoist or jack that will support the weight of the machine; a 6-ton jack is required for jacking one side of the rear axle. It is best to empty the hopper and water tank before jacking the machine.

Always stop the machine on a flat, level surface and block the tires before jacking up the machine.

The front axle should be used when jacking up the front of the machine.

The rear axle should be used when jacking up the rear end of the machine

**FOR SAFETY: When servicing machine, block machine tires before jacking machine up.**

**FOR SAFETY: When servicing machine, jack machine up at designated locations only. Block machine up with jack stands.**

---

## STORING MACHINE

---

Before storing the machine for an extended period of time, the machine needs to be prepped to lessen the chance of rust, sludge, and other undesirable deposits from forming. Contact TENNANT service personnel.

*NOTE: Refer to truck and engine manufacturer's owner's manual for storage information.*

## FREEZE PROTECTION FOR WET DUST CONTROL SYSTEM

1. Drain the water tank with the drain valve located under the tank on the left hand side of the machine.
2. Drain the water lines and pump by opening the drain valve on the bottom of the water pump.
3. Remove and empty the water filter cap, located next to the water pump.



## TRANSPORTING THE MACHINE

---

### TRANSPORTING THE MACHINE

1. Position the front of the machine at the loading edge of the truck or trailer.

**FOR SAFETY: Use truck or trailer that will support the weight of the machine.**

*NOTE: Empty the hopper and water tank before transporting the machine.*

2. If the loading surface is not horizontal or is higher than 380 mm (15 in) from the ground, use a winch to load machine.

If the loading surface is horizontal AND is 380 mm (15 in) or less from the ground, the machine may be driven onto the truck or trailer.

3. To winch the machine onto the truck or trailer, attach the winching chains into the machine tow hooks.

**FOR SAFETY: When loading machine onto truck or trailer, use winch. Do not drive the machine onto the truck or trailer unless the loading surface is horizontal AND is 380 mm (15 in) or less from the ground.**

4. Position the machine onto the truck or trailer as far as possible. If the machine starts to veer off the centerline of the truck or trailer, stop and turn the steering wheel to center the machine.

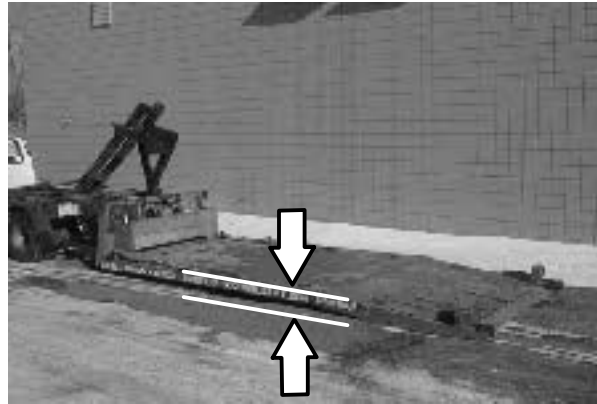

5. Set the parking brake and block the machine tires. Tie down the machine to the truck or trailer before transporting.

The front tie-down locations are on the inside channels of the main frame.

The rear tie-down locations are through the rear channels of the main frame.

6. If the loading surface is not horizontal or is higher than 380 mm (15 in) from the ground, use a winch to unload machine.

If the loading surface is horizontal AND is 380 mm (15 in) or less from the ground, the machine may be driven off the truck or trailer.

**FOR SAFETY: When unloading machine off truck or trailer, use winch. Do not drive the machine off the truck or trailer unless the loading surface is horizontal AND 380 mm (15 in) or less from the ground.**

**SPECIFICATIONS**

**GENERAL MACHINE DIMENSIONS/CAPACITIES**

Item	Dimension/capacity
Length	7112 mm (280 in)
Width	2540 mm (100 in)
Height with hopper lowered	3200 mm (126 in)
Height with hopper fully raised (not tilted)	5690 mm (224 in)
Ceiling height minimum dumping clearance (low dump)	4065 mm (160 in)
Ceiling height minimum dumping clearance (high dump)	6480 mm (255 in)
Maximum dump height (bottom of discharge door)	3048 mm (120 in)
Maximum dump height (bottom of hopper)	3760 mm (148 in)
Minimum dump height (bottom of discharge door)	812 mm (32 in)
Track	N/A mm (N/A in)
Wheelbase	3200 mm (126 in)
Main brush diameter	900 mm (35.5 in)
Main brush length	1728 mm (68 in)
Gutter broom diameter	1120 mm (44 in)
Sweeping path width, main brush only	1728 mm (68 in)
Sweeping path width, main brush and right side gutter broom	2387 mm (94 in)
Sweeping path width, main brush and two gutter brooms	3048 mm (120 in)
Hopper weight capacity	4950 kg (11,000 lb)
Hopper volume capacity	3058 L (4 yd <sup>3</sup> )
Dust filter area	23.80 m <sup>2</sup> (256 sq ft)
Wet dust control water tank	1137 L (300 gal)
GVWR	14850 kg (33,000 lb)
Axle rating (front)	540 kg (12,000 lb)
Axle rating (rear)	9450 kg (21,000 lb)

**GENERAL MACHINE PERFORMANCE**

Item	Measure
Vehicle governed speed	93 kmh (58 mph)
Maximum reverse speed	N/A kmh (N/A mph)
Minimum turning radius	5.8 m (19 ft)
Maximum rated climb and descent angle	N/A° Empty hopper, N/A° Full hopper

**POWER TYPE**

Engine	Type	Ignition	Cycle	Aspiration	Cylinders	Bore	Stroke
Caterpillar 3126BHT	Piston	Diesel	4	Turbo	6	110 mm (4.3 in)	127 mm (5.0 in)
	Displacement		Net power, governed			Torque	
	7.2 L (439 cu in) - (standard)		59 kw (250 hp) @ 2200 rpm (standard)			800 ft lb @ 1440 rpm (standard)	
	Fuel		Cooling system			Electrical system	
	Diesel Fuel tank: 200 L (53 gal)		Water/ethylene glycol antifreeze			12 V nominal	
						160 A alternator	
	Engine lubricating oil with filter						
	21 L (22 qt) 15W40 SAE-CH-4/CG-4 rated engine oil (shallow oil sump)  Use 10W-30 SAE to improve cold starting in temperatures below -18° C (0° F)						

**STEERING**

Type	Power source	Emergency steering
Dual tilt, telescopic steering, variable ratio	Power steering pump	Manual

**HYDRAULIC SYSTEM**

System	Capacity	Fluid Type
Hydraulic reservoir	152 L (40 gal)	TENNANT part no. 65869 (Mobil no. DTE18M) - above 0° C (32° F)
Hydraulic total	170L (45 gal)	TENNANT part no. 65870 (Mobil no. DTE13M) - below 0° C (32° F)

**BRAKING SYSTEM**

Type	Operation
Service brakes	4 Wheel air assist

# SPECIFICATIONS

TOP VIEW

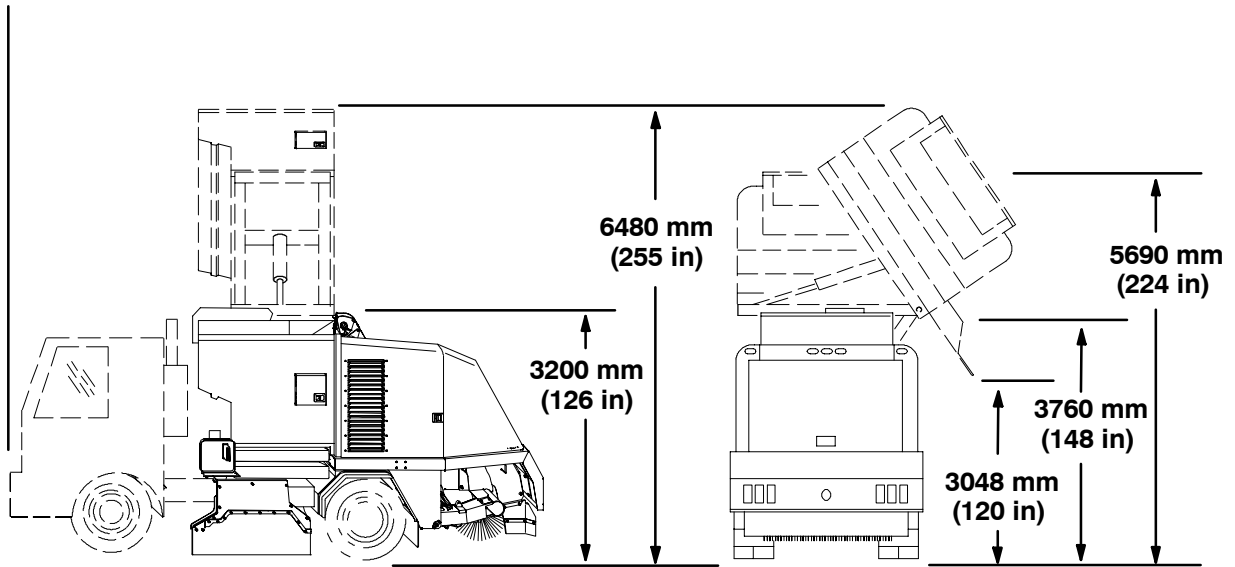
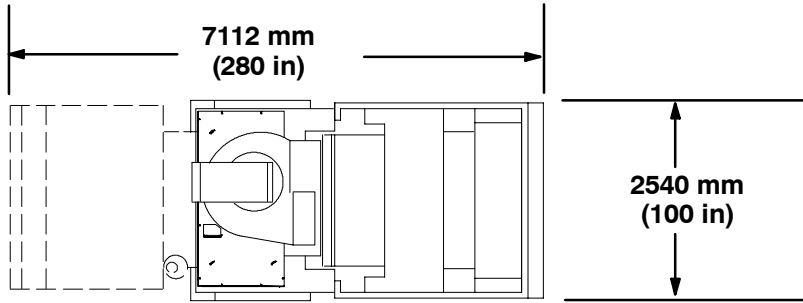

SIDE VIEW

REAR VIEW

## MACHINE DIMENSIONS

353773

## INDEX

**A**

Air brake pressure gauge, 21  
 Alarms  
   Activate park brake, 43  
   Check hydraulic filter, 43  
   Conveyor not back, 41  
   Conveyor stall, 41, 55  
   Hopper fire, 42  
   Hopper up error, 41  
   Hydraulic fluid low, 45  
   Machine not level , 45  
   Overspeed engine , 44  
   Overspeed travel , 44  
   Reduce engine RPM, 42  
   Shake filter , 44  
   Shake filter, 55  
   Tank low, pump off, 42  
   Worn main brush, 43  
 Auto Lube (option), 81

**B**

Bars  
   Hopper lift support, 40  
   Hopper tilt support, 40  
 Belts, Conveyor, 97  
 Brakes, 46  
   System specifications, 123  
 Bright headlights light, 22  
 Brush hourmeter, 24  
 Brush wear indicator, 27  
 Brushes, 49–50, 60, 105–110  
   Checking main brush pattern, 109  
   Gutter broom(s), 110  
   Main brush, 105–109  
   Rear skirt, 113  
   Replacing the main brush, 105

**C**

Capacities, 122  
 Caps, Hydraulic filler, 82  
 Center control panel switches, 13  
 Chart, Maintenance, 72–74  
 Check hydraulic filter alarm, 43  
 Control panel  
   Bright headlights light, 22  
   Signal light, 22

Controls, 11–13  
   Activate park brake alarm, 43  
   Air brake pressure gauge, 21  
   Brush hourmeter, 24  
   Brush wear indicator, 27  
   Check hydraulic filter alarm, 43  
   Conveyor forward switch, 33  
   Conveyor not back alarm, 41  
   Conveyor in switch, 33  
   Conveyor out switch, 34  
   Conveyor reverse switch, 33, 55  
   Conveyor water spray switch, 34  
   Display clock, 23  
   Engine coolant temperature gauge, 20  
   Engine oil pressure gauge, 20  
   Fast idle switch, 16  
   Filter shaker switch, 29  
   Front water spray switch, 35  
   Fuel level gauge, 21, 22  
   Fuse, 36, 37  
   Gutter broom light switch (option), 39  
   Gutter broom speed/pressure adjustment (option), 38  
   Hopper down switch, 31  
   Hopper dump switch, 32  
   Hopper fire alarm, 42  
   Hopper home switch, 32  
   Hopper up error alarm, 41  
   Hopper up switch, 31  
   Hopper work light switch, 18  
   Hourmeter, 24  
   Hydraulic fluid low alarm, 45  
   Ignition switch, 15  
   Latches, 39  
   Left side gutter broom switch (option), 30  
   Left side gutter broom tilt switch, 38  
   Left side water spray switch (option), 35  
   Machine not level alarm, 45  
   More switch, 24  
   Operation, 15, 41  
   Overspeed engine alarm, 44  
   Overspeed travel alarm, 44  
   PTO kill switch , 17  
   PTO switch, 25  
   Pushbutton range selector, 17  
   Rear axle shift control switch, 16  
   Rear work light switch, 18  
   Revolving light switch (option), 39  
   Right side gutter broom switch, 30  
   Right side gutter broom tilt switch, 38  
   Right side instrument console, 18  
   Right side water spray switch, 35

**Controls (cont.)**

- Shake filter alarm, 44
- Speedometer, 19
- Start up screen, 23
- Super sweep switch, 27
- Sweep mode switch, 27
- Sweep switch, 26
- Symbols, 10–12
- Tachometer, 19
- Tank low, pump off alarm, 42
- Touch panel, 23
- Transmission temperature gauge, 21
- Vacuum fan switch, 30
- Voltmeter, 20
- Water flow switch, 28
- Water tank level gauge, 28
- Worn main brush alarm, 43

**Conveyor, 97**

- Adjusting the conveyor height, 98
- Bearings, 79
- Belt, 97
  - Flushing, 99
  - Replacement, 102
  - Splicing the belt, 103
  - Tension springs, 102
  - Tracking adjustment, 100
- Forward switch, 33
- In switch, 33
- Lift cylinders, 79
- Lift pivots, 79
- Not back alarm, 41
- Not back alarm, 41
- Out switch, 34
- Paddles, 97, 102
- Reverse switch, 33, 55
- Roller, 99
- Skirts, 97, 102, 113, 114
- Stall alarm, 41
- Stall alarm, 41, 55
- Tilt cylinder, 80
- Water spray switch, 34

Custom sweep settings, Setting the custom mode, 50, 51

**D**

- Debris, Conveyor reverse switch, 55
- Debris hopper, 93–95
- Dimensions, 122
- Dimensions, Machine, 124
- Disengaging hopper lift support bar, 67–69
- Disengaging hopper tilt support bar, 63–64
- Display clock, 23
- Display screen
  - Brush hourmeter, 24
  - Display clock, 23
  - Hourmeter, 24
  - Start up screen, 23
- Doors
  - Cab, Latch, 39
  - Rear, Latch, 39
  - Side, Latch, 39
- Drag shoes, 118
  - Drag shoe lift cylinder, 78
  - Drag shoe pivot, 77
- Dry dust control (option), 117
  - Gutter broom skirt(s), 117
  - Rear skirts, 117
  - Skirts, 116
  - Skirt wing pivots, 80
  - Wing skirts, 117
- Dust control, Wet, Filter, 91, 92
- Dust control bumpers (option), 76
- Dust control skirt cylinder (option), 76
- Dust control skirt pivots (option), 76
- Dust filter, 93
  - Cleaning, 93



**E**

Electrical, Fuse, 36, 37  
 Emptying the hopper, 57–59  
   Machine not level alarm, 45  
 Engaging hopper lift support bar, 65–67  
 Engaging the hopper tilt support bar, 61–63  
 Engine, 74, 86–88  
   Air cleaner, 86  
   Air filter indicator, 46  
   Cooling system, 85  
   Engine coolant temperature gauge, 20  
   Fuel level gauge, 21  
   Ignition switch, 15  
   Oil level, 46  
   Oil pressure gauge, 20  
   Overspeed engine alarm, 44  
   Specifications, 123  
   Speedometer, 19  
   Tachometer, 19  
   Valve lash adjustment, 86  
   Voltmeter, 20  
 Engine air cleaner, 86  
 Engine coolant temperature gauge, 20  
 Engine oil pressure gauge, 20  
 Engine speeds, 19  
 Engine valves, 86

**F**

Fast idle switch, 16  
 Filter shaker switch, 29  
 Filters  
   Hydraulic, 85  
   Hydraulic, 82  
   Hydraulic pump load sense, 84  
   Shake alarm, 55  
   Wet dust control, 91, 92  
 Freeze protection, Wet dust control, 119  
 Front water spray switch, 35  
 Fuel filter, 46  
 Fuel level, 46  
 Fuel level gauge, 21  
 Fuse, 36, 37

**G**

Gauges  
   Air brake pressure, 21  
   Engine coolant temperature, 20  
   Engine oil pressure, 20  
   Fuel level gauge, 21  
   Right side instrument console, 18  
   Speedometer, 19  
   Tachometer, 19  
   Transmission temperature, 21  
   Voltmeter, 20  
   Water tank level, 28  
 Gutter broom light switch (option), 39  
 Gutter broom pivot, 75  
 Gutter broom skirt(s), 117  
 Gutter broom speed/pressure  
   adjustment (option), 38  
 Gutter broom support arms, 75  
 Gutter broom support rods, 75  
 Gutter broom(s), 110  
   Bristle length, 110  
   Checking and adjusting pattern, 111  
   Checking brush pattern, 110  
   Left side gutter broom tilt switch, 38  
   Replacement, 110  
   Right side gutter broom tilt switch, 38  
   Speed/pressure adjustment (option), 38  
 Gutter brooms  
   Left side gutter broom switch (option), 30  
   Right side gutter broom switch, 30  
 GVWR, 8, 49, 122

**H**

Heated mirror switch (option), 16  
Hopper, 93–95  
    Access door seal, 115  
    Chute door seals , 114  
    Chute door skirt, 114  
    Cover seal, 115  
    Disengaging hopper lift support bar, 67–69  
    Disengaging hopper tilt support bar, 63–64  
    Down switch, 31  
    Dump switch, 32  
    Dust filter, Replacing, 93–95  
    Engaging hopper lift support bar, 65–67  
    Filter cleaning, 93  
    Fire alarm, 42  
    Hopper filter, Shake filter alarm, 44  
    Home switch, 32  
    Hopper Up error alarm, 41  
    Lift support bars, 40  
    Lift/tilt, 74  
        Conveyor, 31  
    Lower switch, 29  
    Thermo-Sentry™, 93  
    Tilt support bar, 40  
    Up switch, 31  
    Work light switch, 18  
Hoses, Hydraulic, 85  
Hourmeter, 24  
How the machine works, 46  
Hydraulics, 82–84  
    Cooler, 85  
    Filler cap, 82  
    Filters, Check filter alarm, 43, 82  
    Fluid, 83  
    Fluid filter, 85  
    Fluid level, 82, 86, 87  
    Hoses, 85  
    Fluid low alarm, 45, 82  
    Pump load sense filters, 84  
    Reservoir, 82, 86  
    System specifications, 123

**I**

Ignition switch, 15  
Inclines, Operating on, 60

**J**

Jack points, 119  
Joystick, 8

**K**

Knobs, Parking brake, 15

**L**

Latches, 39  
    Cab doors, 39  
    Rear door, 39  
    Side doors, 39  
Left side gutter broom switch (option), 30  
Left side gutter broom tilt switch, 38  
Left side water spray switch (option), 35  
Lights  
    Bright headlights, 22  
    Gutter broom light switch (option), 39  
    Preheat , 22  
    Revolving light switch (option), 39  
    Signal, 22  
Lubrication, 74  
    Auto Lube (option), 81

**M**

Machine  
    Components, 9  
    Dimensions, 124  
    Jacking, 119  
    Leaks, 46, 60  
    Not level alarm, 45, 60  
    Right side instrument console, 18  
    Tie down location, 121  
    Travel speed, Overspeed travel alarm, 44  
    Troubleshooting, 69, 70  
Main brush, 50, 105–109  
    Checking brush pattern, 105, 109  
    Drag shoe cylinders, 78  
    Idler bearing, 77  
    Lift cylinder, 78  
    Maintenance, 105  
    Support arms, 77  
    Worn main brush alarm, 43

## Maintenance, 71

- Adjusting the main brush pattern, 109
- Brushes, 105
- Checking and adjusting gutter broom pattern, 111
- Conveyor, 97
- Conveyor belt, Tracking, 100
- Debris hopper, 93
- Drag shoes, 118
- Dry dust control rear skirts, 117
- Dry dust control skirts, 116
- Dry dust control wing skirts, 117
- Engine air cleaner, 86
- Gutter broom(s), 110
- Hopper access door seal, 115
- Hopper chute door seals, 114
- Hopper chute door skirt, 114
- Hopper dust filter, 93
- Hopper filter cover seal, 115
- Intervals, 72–74
- Lubrication
  - Auto Lube (option), 81
  - Conveyor bearings, 79
  - Conveyor lift cylinders, 79
  - Conveyor lift pivots, 79
  - Conveyor tilt cylinder, 80
  - Drag shoe lift cylinder, 78
  - Drag shoe pivot, 77
  - Dry dust control skirt wing pivots, 80
  - Dust control bumper pivots (option), 76
  - Dust control skirt cylinder, 76
  - Dust control skirt pivots (option), 76
  - Engine, 74, 86
  - Gutter broom pivot, 75
  - Gutter broom support arms, 75
  - Gutter broom support rods, 75
  - Hopper lift/tilt, 74
  - Main brush and drag shoe cylinders, 78
  - Main brush idler bearing, 77
  - Main brush lift cylinder, 78
  - Main brush support arms, 77
  - Propulsion shaft slip joint, 80
- Recommended, 8
- Replacing gutter broom(s), 110
- Replacing the conveyor belt, 102
- Skirts and seals, 113
- Transmission access, 87
- Vacuum duct seals, 115
- Valve lash adjustment, 86
- Wet dust control system, 91

## Maintenance chart, 72–74

## More switch, 24

## O

- Operation, 8–60
- Operation on inclines, 60
- Operator control switch, 15
- Operator Responsibility, 8
- Options
  - Dry dust control
    - Rear skirts, 117
    - Skirts, 116
    - Wing skirts, 117
  - Dry dust control skirt wing pivots, 80
  - Dust control bumpers, 76
  - Dust control skirt cylinder, 76
  - Dust control skirt pivots, 76
  - Gutter broom dust control skirt(s), 117
  - Gutter broom light switch, 39
  - Gutter broom speed/pressure adjustment, 38
  - Heated mirror switch, 16
  - Left side gutter broom tilt switch, 38
  - Rear work light switch, 18
  - Revolving light switch, 39
  - Right side gutter broom tilt switch, 38
  - Vacuum duct seals, 115
  - Wet dust control, Filter, 91, 92
- Overspeed engine alarm, 44

## P

- Parking brake, Activate park brake alarm, 43
- Parking brake knob, 15
- Post-operation checklist, 60
- Power take off
  - PTO kill switch, 17
  - Reduce engine RPM alarm, 42
- Pre-operation checklist, 46–49
- Preheat light, 22
- Propulsion shaft slip joint, 80
- PTO kill switch, 17
- PTO switch, 25
- Pushbutton range selector, 17
  - Digital display, 17
- Pushing machine, 120
- Pushing, towing, and transporting machine, 120

**R**

Radiator, Exterior, 85  
Rear axle shift control switch, 16  
Rear skirts, Dry dust control, 117  
Rear work light, switch , 18  
Reduce engine RPM alarm, 42  
Reservoir, hydraulic, 82, 86  
Revolving light switch (option), 39  
Right hand steering instrument console, 11  
Right side gutter broom switch, 30  
Right side gutter broom tilt switch, 38  
Right side instrument console, 18  
Right side water spray switch, 35

**S**

## Safety

Disengaging hopper lift support bar, 67–69  
Disengaging hopper tilt support bar, 63–64  
Engaging hopper lift support bar, 65–67  
Hopper lift support bars, 40  
Hopper tilt support bar, 40  
Labels, 6  
Precautions, 4

Seals, 113–115

Service records, 60

Setting the custom mode, 50, 51

Shake filter alarm, 44, 55

Side brush, 50

Signal light, 22

Skirts, 60, 113

Brush compartment, 113  
Conveyor, 113, 114  
Dry dust control, 116

Specifications, 122–123

Braking system, 123  
GVWR, 122  
Hydraulic system, 123  
Machine capacities, 122  
Machine dimensions, 122  
Machine performance, 123  
Power type, 123  
Steering, 123

Speedometer, 15, 19

Start up screen, 23  
Brush hourmeter, 24  
Hourmeter, 24

Starting the machine, 47–49

Steering, 46  
Specifications, 123

Stop sweeping, 56

Stopping the machine, 59–61

Storing machine,  
Freeze protection, 119

Super sweep switch, 27

Sweep mode, Super sweep switch, 27

Sweep mode switch, 27

Sweep modes, 50

Sweep switch, 26

Sweeping, 54–57  
Filling the water tank, 52–55

Sweeping and brush information, 49–50

## Switches

Brush wear indicator, 27  
Conveyor forward, 33  
Conveyor in, 33  
Conveyor out, 34  
Conveyor reverse, 33, 55  
Conveyor water spray, 34  
Fast idle, 16  
Filter shaker, 29  
Front water spray, 35  
Gutter broom light (option), 39  
Heated mirror (option), 16  
Hopper down, 31  
Hopper dump, 32  
Hopper home, 32  
Hopper up, 31  
Hopper work light, 18  
Left side gutter broom (option), 30  
Left side gutter broom tilt, 38  
Left side water spray (option), 35  
More switch, 24  
Operator control, 15  
Power takeoff , 23  
PTO, 25  
PTO kill, 17

## Switches (cont.)

- Rear axle shift control, 16
- Rear work light, 18
- Revolving light (option), 39
- Right side gutter broom, 30
- Right side gutter broom tilt, 38
- Right side water spray, 35
- Super sweep, 27
- Sweep, 26
- Sweep mode, 27
- Touch panel, 23
- Vacuum fan, 30
- Water flow, 28

**T**

## Tachometer,

- Engine speeds, 19

## Tank low, pump off alarm, 42

## Thermo-sentry™, 93

## Tie down location, 121

## Touch Panel

- Conveyor control screen
  - Conveyor forward switch, 33
  - Conveyor in switch, 33
  - Conveyor out switch, 34
  - Conveyor reverse switch, 33
- Conveyor water spray switch, 34
- Hopper control screen
  - Hopper down switch, 31
  - Hopper dump switch, 32
  - Hopper home switch, 32
  - Hopper up switch, 31
- Left side gutter broom switch (option), 30, 38
- Left side water spray switch (option), 35
- PTO switch, 25
- Right side gutter broom switch, 30
- Right side water spray switch, 35
- Sweep mode screen, 23
  - Brush wear indicator, 27
  - Filter shaker switch, 29
  - Super sweep switch, 27
  - Sweep mode switch, 27
  - Vacuum fan switch, 30
  - Water flow switch, 28
- Sweep switch, 26
- Water tank level gauge, 28

## Touch panel, 14, 23

- Water tank level gauge, Filter shaker switch, 28

## Touch panel, Full power, 19

## Towing machine, 120

## Transmission

- Pushbutton range selector, 17
- Temperature gauge, 21

## Transmission Access, 87

## Transmission temperature gauge, 21

## Transporting machine, 120

## Transporting the machine, 120

## Travel speed, 123

## Troubleshooting, 69, 70

## Turning radius, 123

**U**

## Upper control panel switches, 12

**V**

## Vacuum duct seals, 115

## Vacuum fan, Vacuum fan switch, 30

## Vacuum fan switch, 30

## Voltmeter, 20

**W**

## Water flow switch, 28

## Water pump, Tank low, pump off alarm, 42

## Water tank, 46

## Water tank level gauge, 28

## Water trap, 46

## Weight limit, 8, 49, 122

## Wet dust control filter, Filter, 91, 92

## Wet dust control system, 91

- Front water spray switch, 35
- Water flow switch, 28

## Wing skirts, Dry dust control, 117

## Worn main brush alarm, 43

