



636

Air Sweeper Operator Manual



CloudMaker[®] Technology
Vari-track[™] Technology

CE
Global

www.greenmachines.com

9006280
Rev. 04 (10-2011)



This manual is furnished with each new model. It provides necessary operation and maintenance instructions.



Read this manual completely and understand the machine before operating or servicing it.

Read this manual completely and understand the machine before operating or servicing it.

This machine will provide excellent service. However, the best results will be obtained at minimum costs if:

- The machine is operated with reasonable care.
- The machine is maintained regularly - per the machine maintenance instructions provided.
- The machine is maintained with manufacturer supplied or equivalent parts.



PROTECT THE ENVIRONMENT

Please dispose of packaging materials, old machine components such as batteries, hazardous fluids, including antifreeze and oil, in an environmentally safe way according to local waste disposal regulations.



Always remember to recycle.

MACHINE DATA

Please fill out at time of installation for future reference.

Model No. - _____

Serial No. - _____

Machine Options - _____

Sales Rep. - _____

Sales Rep. phone no. - _____

Customer Number - _____

Installation Date - _____

The following publications are included with this machine:

Operators Manual
Service Schedule
Parts Catalog
Kubota Engine Manual

The following optional publications can be purchased separately:

Kubota Engine Workshop Manual
Kubota Engine Parts Catalog

Please contact a local Green Machines distributor to order additional publications.

Green Machines

Bankside, Falkirk FK2 7XE
Scotland, United Kingdom
Phone: (+44) 1324-611666
www.greenmachines.com

Tennant Company

PO Box 1452
Minneapolis, MN 55440
Phone: (800) 553-8033 or (763) 513-2850
www.tennantco.com



CALIFORNIA PROPOSITION 65 WARNING:

Engine exhaust from this product contains chemicals known to the State of California to cause cancer, birth defects, or other reproductive harm.

Vari-track Technology is a US registered and unregistered trademark of Green Machines Company.

Specifications and parts are subject to change without notice.

Copyright © 2009, 2010, 2011 Green Machines Company, Printed in U.S.A.

CONTENTS

	Page		Page
Safety Precautions	3	Starting The Machine	24
Operation	7	Turning Off The Machine	25
Machine Components	7	While Operating The Machine	25
Controls And Instruments	8	Sweeping	26
Symbol Definitions	10	Driving Over Curbs	27
Operation Of Controls	11	Raising / Lowering The Hopper	28
Drive Lever		Engaging The Hopper Safety Arm	29
(Forward / Neutral / Reverse)	11	Disengaging The Hopper Safety Arm	30
Brush Levers	11	Using The Wander Hose	30
Fuel Gauge	11	Emptying The Hopper	32
Tachometer	11	Cleaning The Machine	33
Hour Meter	11	Cleaning The Vacuum Fan Assembly	37
Engine Temperature Gauge	12	Checking / Filling The Water Tank	37
Parking Brake Indicator (Red)	12	Using The Machine Display	
Turn Signal / 4-Way Warning Light		Module (MDM) System	38
Indicator (Green)	12	Adjusting The Engine Speed	38
Charging System Malfunction		Using The Engine Speed Boost	39
Indicator (Amber)	12	Machine Display Module (MDM)	
Engine Oil Indicator (Red)	12	Fault Screens	40
Headlight High Beam Indicator	12	Options	42
Glow Plug Indicator (Amber)	13	Pressure Washer (Option)	42
Hopper Drain Switch	13	Rear View Camera (Option)	43
Transit / Work Modes Switch	14	Radio And Compact Disk	
Brush Speed Knob	14	Player (Option)	43
Vacuum Fan Speed Knob	15	Automatic Greasing (Option)	43
Vacuum Fan Speed Boost	15	Filling The Automatic Greasing	
Windshield Defroster Switch	15	System Reservoir	43
Master Light Switch	16	Winter Equipment (Option)	44
Overhead Work Light Switch	16	Snow Brush (Option)	44
Rear Fog Light Switch	16	Snow Plows (Option)	45
Cab Temperature Control Knob	16	Grit (Sand / Road Salt)	
Heater Fan Switch	17	Dispenser (Option)	46
Air Conditioner (Option)	17	Machine Troubleshooting	47
4-Way Warning Light Switch	17	Conditions Table	49
Warning Beacon / Audible		Maintenance	50
Alarm Switch	17	Maintenance Chart	50
Water Switch (Dust Suppression)	18	Lubrication	55
Water Flow Control Knob	18	Lubrication Points	55
Brush Pressure Adjustment Knob	19	Hydraulics	56
Parking Brake Lever	19	Hydraulic Hoses	57
Accelerator Pedal	19	Hydraulic Fluid	57
Brake Pedal	19	Engine	58
Steering Wheel Height		Engine Oil	58
Adjustment Handle	20	Cooling System	58
Headlight And Multifunctional Switch ..	20	Engine Belt	58
Windshield Wiper / Washer Switch	20	Air Filter	59
Horn Button	20	Fuel Filters	60
Operator Seat	21	Fuel Lines	60
Seat Belts	21	Priming The Fuel System	60
Door Locks	21	Valve Clearances	60
Brush Information	22	Battery	61
How The Machine Works	22	Fuses	62
Pre-operation Checklist	23	Replacing The Fuses	62
Post Operation Cleaning	23		

CONTENTS

	Page
Brushes	63
Replacing The Brushes	63
Adjusting The Brush Angle	63
Brush Linkage	64
Dust Suppression / Vacuum	65
Adjusting / Replacing The Nozzle Flap	65
Vacuum Nozzle Skid	66
Cast Iron Skid	66
Spray Jets	66
CloudMaker	67
Water Tank	67
Drain Cap Filter	67
Water Tank Door Retainer Chain	67
Water Level Sensor	67
Hopper	68
Hopper Door, Hopper Inlet, And Vacuum Fan Access Door Seals ...	68
Hopper Drain Seal	68
Hopper Cyclones Screens	68
Hopper Drain Screen	68
Hopper External Drain Tube	69
Hopper Door Screen	69
Hopper Raised Safety Switch	69
Vacuum Fan Door Safety Switch	69
Vacuum Fan Access Door	69
Cab	70
Windshield Wiper Blades	70
Rear View Camera (Option)	70
Windshield Washer Fluid	70
Steering And Suspension	71
Brakes And Tires	72
Service Brakes	72
Parking Brakes	72
Tires	72
Wheel Torque	72
Wander Hose	73
Pressure Washer (Option)	73
Tilting / Lowering The Cab	74
Tilting The Cab	74
Lowering The Cab	74
Tilting / Lowering The Hopper Manually ...	75
Tilting The Hopper Manually	75
Lowering The Hopper Manually	76
Towing / Transporting The Machine	77
Towing The Machine	77
Transporting The Machine	77
Machine Jacking	79
Storage And Freeze Protection	80
Storing The Machine	80
Freeze Protection	80
Specifications	81
General Machine Dimensions/Capacities .	81
General Machine Performance	81
Hydraulic System	82
Steering	82
Power Type	82
Tires	82
Machine Dimensions	83

SAFETY PRECAUTIONS

The following precautions are used throughout this manual as indicated in their description:

 **WARNING:** To warn of hazards or unsafe practices that could result in severe personal injury or death.

 **CAUTION:** To warn of unsafe practices that could result in minor or moderate personal injury.

FOR SAFETY: To identify actions that must be followed for safe operation of equipment.

The machine is suited to sweep disposable debris. Do not use the machine other than described in this Operator Manual.

The following information signals potentially dangerous conditions to the operator or equipment:

 **WARNING:** Moving belt and fan. Keep away.

 **WARNING:** Machine emits toxic gases. Serious injury or death can result. Provide adequate ventilation.

 **WARNING:** Raised hopper may fall. Engage hopper support arm.

 **WARNING:** Lift arm pinch point. Stay clear of hopper lift arms.

 **WARNING:** Flammable materials can cause explosion or fire. Do not use flammable materials in tank. Only use water.

 **WARNING:** Do not spray people or animals. Severe personal injury can result. Wear eye protection. Hold sprayer with two hands.

FOR SAFETY:

1. **Do not operate machine:**
 - Unless trained and authorized.
 - Unless operator manual is read and understood.
 - Unless mentally and physically capable of following machine instructions.
 - If it is not in proper operating condition.
 - In flammable or explosive areas.
2. **Before starting machine:**
 - Check for fuel, oil, and liquid leaks.
 - Keep sparks and open flame away from refueling area.
 - Make sure all safety devices are in place and operate properly.
 - Check brakes and steering for proper operation.
 - Adjust seat and fasten seat belt.
3. **When starting machine:**
 - Keep foot on brake and place directional lever in neutral.
4. **When using machine:**
 - Do not pick up burning or smoking debris, such as cigarettes, matches or hot ashes
 - Use brakes to stop machine.
 - Go slow on inclines and slippery surfaces.
 - Use care when reversing machine.
 - Move machine with care when hopper is raised.
 - Make sure adequate clearance is available before raising hopper.
 - Do not make adjustments on Machine Display Module (MDM) System while the machine is moving. Always stop machine before making adjustments.
 - Do not carry passengers on machine.
 - Always follow safety and traffic rules.
 - Report machine damage or faulty operation immediately.
5. **Before leaving or servicing machine:**
 - Stop on level surface.
 - Place the drive lever in neutral.
 - Set parking brake.
 - Turn off machine.
 - Remove key from ignition.

SAFETY PRECAUTIONS

6. **When servicing machine:**
 - **Avoid moving parts. Do not wear loose clothing or jewelry.**
 - **Block machine tires before jacking machine up.**
 - **Jack machine up at designated locations only. Support machine with jack stands.**
 - **Use hoist or jack that will support the weight of the machine.**
 - **Wear eye and ear protection when using pressurized air or water.**
 - **Disconnect battery connections before working on machine.**
 - **Avoid contact with battery acid.**
 - **Avoid contact with hot engine coolant.**
 - **Do not remove cap from radiator when engine is hot.**
 - **Allow engine to cool.**
 - **Keep flames and sparks away from fuel system service area. Keep area well ventilated.**
 - **Use cardboard to locate leaking hydraulic fluid under pressure.**
 - **Use Tennant supplied or approved replacement parts.**

7. **When loading/unloading machine onto/off truck or trailer:**
 - **Turn off machine.**
 - **Use truck or trailer that will support the weight of the machine.**
 - **Use winch. Do not drive the machine onto/off the truck or trailer unless the load height is 380 mm (15 in) or less from the ground.**
 - **Set parking brake after machine is loaded.**
 - **Block machine tires.**
 - **Tie machine down to truck or trailer.**

SAFETY PRECAUTIONS

The following safety labels are mounted on the machine in the locations indicated. If any label becomes damaged or illegible, install a new label in its place.



SAFETY PRECAUTIONS



OPERATION

MACHINE COMPONENTS



1. Wander hose
2. Hopper
3. Warning beacon
4. Overhead work lights
5. Headlights / Turn signals
6. Right access door
7. Vacuum fan access door
8. Right brush
9. CloudMaker (dust suppression)
10. Spray jets (dust suppression)
11. Rear view camera (Optional)

12. Rear fog light
13. Water tank
14. Taillights / Turn signals
15. Water tank level tube
16. Water tank door
17. Left access door
18. Wander hose access door
19. Hydraulic fluid level indicator
20. Engine compartment
21. Left brush

OPERATION

CONTROLS AND INSTRUMENTS



1. Left Brush Lever
2. Right Brush Lever
3. Drive Lever
(Forward / Neutral / Reverse)
4. Glow Plug Indicator (Amber)
5. Engine Temperature Gauge
6. Engine Oil Indicator (Red)
7. Charging System Malfunction Indicator (Amber)
8. Turn Signal / 4-Way Warning Light Indicator (Green)
9. Parking Brake Indicator (Red)
10. Fuel Gauge
11. Headlight High Beam Indicator
12. Tachometer
13. Hour Meter
14. Wander Hose Switch
15. Pressure Washer Switch (Optional)
16. Machine Display Module (MDM)
17. Hopper Drain Switch
18. Hopper Raise / Lower Switch
19. Transit / Work Modes Switch
20. Brush Speed Knob
21. Vacuum Fan Speed Knob
22. Windshield Defroster Switch
23. Overhead Work Light Switch
24. Rear Fog Light Switch
25. Master Light Switch
26. Air Conditioner Switch (Optional)
27. Heater Fan Switch
28. Warning Beacon / Audible Alarm Switch
29. 4-Way Warning Light Switch
30. Water Control Knob (Dust Suppression)

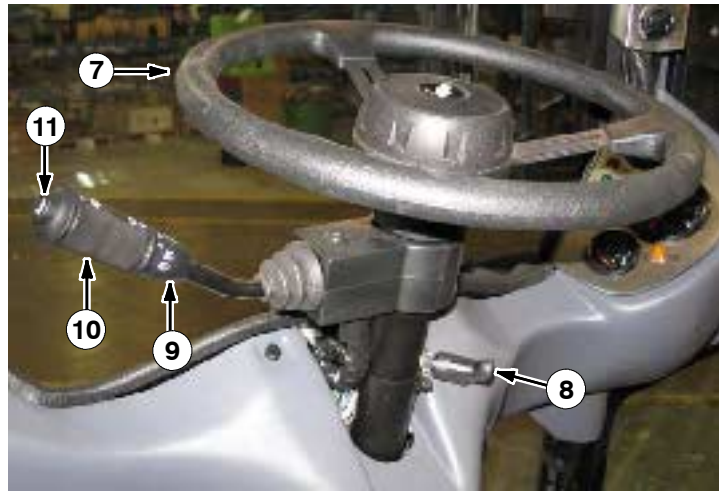
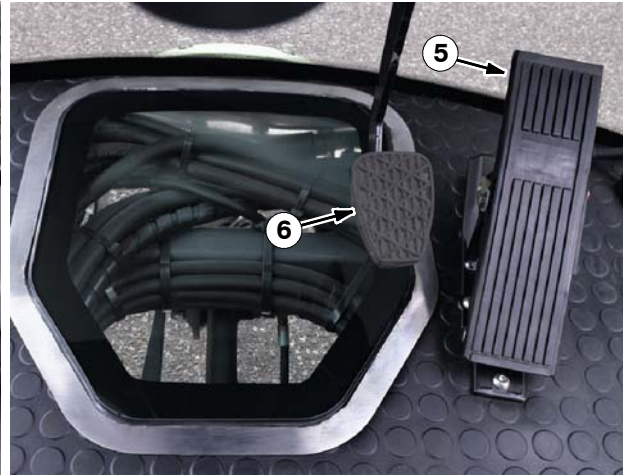



- 1. Parking Brake Lever
- 2. Cab Temperature Control Knob
- 3. Brush Pressure Adjustment Knob
- 4. Water Flow Control Knob

- 7. Steering Wheel
- 8. Steering Wheel Height Adjustment Handle
- 9. Headlight and Multifunctional Switch
- 10. Windshield Wiper / Washer Switch
- 11. Horn Button

OPERATION

SYMBOL DEFINITIONS

These symbols are used on the machine to identify controls, displays, and features.

	Transit / Work Mode		Hazard Lights
	Brush Speed		Signal Light / 4-Way Hazard Light
	Brush Pressure		Glow Plug (Preheat)
	Vacuum Fan Speed		Voltmeter
	Horn		Air Conditioner (Option)
	Warning Beacon		Parking Brake
	Operating Lights		Bright Headlights
	Windshield Defroster		Overhead Lights
	Oil Pressure		Dust Suppression 0
	Master Lights		Dust Suppression 1
	Heater Fan		Dust Suppression 2
	Rear Fog Lights		Water Flow Control
	Raise / Lower Hopper		Wander Hose (Option)
	Hopper Drain		Pressure Washer (Option)

OPERATION OF CONTROLS

**DRIVE LEVER
(FORWARD / NEUTRAL / REVERSE)**

NOTE: Lift the lock toward the ball handle before moving the drive lever to the desired position.

Forward: Place the *Drive lever* into the forward position and press the accelerator pedal.

Neutral: Place the *Drive lever* into the middle position.

Reverse: Place the *Drive lever* into the reverse position and press the accelerator pedal.



BRUSH LEVERS

Use the *Brush levers* to adjust the brush path width and edge sweep.

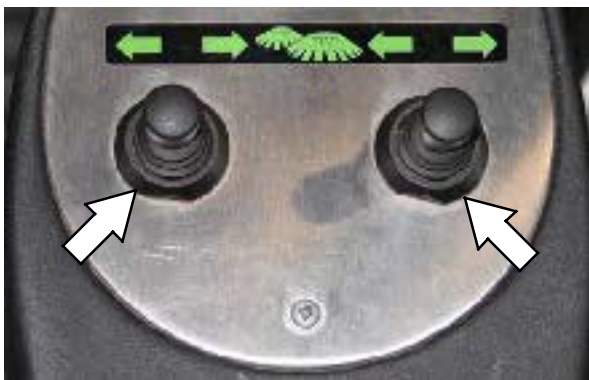

FUEL GAUGE

The *Fuel gauge* displays the amount of fuel in the tank. Use diesel fuel only.



TACHOMETER

The *Tachometer* displays the engine speed in rotations per minute (rpm).



HR METER

The *Hour meter* displays the number of hours the machine was operated. Use this information to determine machine service intervals.



OPERATION

ENGINE TEMPERATURE GAUGE

The *Engine temperature gauge* indicates the engine temperature.



CHARGING SYSTEM MALFUNCTION INDICATOR (AMBER)

The *Charging system malfunction indicator* illuminates when the alternator is not charging the battery.



PARKING BRAKE INDICATOR (RED)

The *Parking brake indicator* illuminates when the parking brake is engaged.



ENGINE OIL INDICATOR (RED)

The *Engine oil indicator* illuminates when the oil pressure is low.



TURN SIGNAL / 4-WAY WARNING LIGHT INDICATOR (GREEN)

The *Turn signal / 4-way warning light indicator* illuminates when the turn signals or 4-way warning lights are activated.



HEADLIGHT HIGH BEAM INDICATOR

The *Headlight high beam indicator* illuminates when the headlight high beams are on.



GLOW PLUG INDICATOR (AMBER)

The *Glow plug indicator* illuminates when the ignition switch is turned clockwise far enough to activate light, but not far enough to start the engine.

**HOPPER DRAIN SWITCH**

Use the *Hopper drain switch* to drain excess water from the hopper.



OPERATION

TRANSIT / WORK MODES SWITCH

Transit Mode (top position) is for moving between job sites. The machine can reach speeds up to 40 km/h (25 mph) when in this mode. The front wheels automatically track out to provide more stability when the machine exceeds 5 km/h (approximately 3 mph). The brushes raise and stop rotating, the vacuum head raises, and the vacuum fan stops operating.



Work Mode 2 (bottom position) is for moving short distances between work areas and driving over curbs or speed bumps. The machine can reach speeds up to 16 km/h (9 mph) when in this mode. The brushes raise and stop rotating, the vacuum head raises, and the vacuum fan stops operating. The machine automatically provides increased traction.



Work Mode 1 (middle position) is for sweeping. The machine can reach speeds up to 12 km/h (8 mph) when in this mode. If the front wheels are in the out position, they will automatically track in when the machine exceeds 5 km/h (approximately 3 mph). The brushes lower and begin rotating, the vacuum head lowers, and the vacuum fan begins operating.



BRUSH SPEED KNOB

Turn the *Brush speed knob* clockwise to increase the speed of both brushes and counterclockwise to decrease the speed of both brushes.



VACUUM FAN SPEED KNOB

Turn the *Vacuum fan speed knob* clockwise to increase the vacuum and counterclockwise to decrease the vacuum.

NOTE: For normal operating conditions the vacuum fan speed should be set to below 2400 rpm.



Reduce the vacuum fan speed to less than 2400 rpm before the countdown bar expires. It must be reduced for at least 30 seconds or the machine must be stopped and the drive lever placed in neutral for five seconds before returning to vacuum fan speed boost. If not, an audible alarm will sound at the end of the five minutes, the fan will shut off, and a warning message will appear on the MDM display.



VACUUM FAN SPEED BOOST

The vacuum fan speed can be set to above 2400 rpm (boost) for a short time (5 minutes). A countdown bar appears on the MDM display.



To reset the vacuum fan speed boost limiting system, stop the machine and place the drive lever in neutral. Restart the machine and turn the vacuum speed to below 2400 rpm.

This vacuum fan speed boost is available for only five 5-minute intervals per hour. After five boost periods, the vacuum fan speed will be limited to 2300 rpm for the rest of the hour

WINDSHIELD DEFROSTER SWITCH

Use the *Windshield defroster switch* to defrost the windshield.



OPERATION

MASTER LIGHT SWITCH

Use the 3-position *Master light switch* to control the headlights, overhead work lights, and rear fog lights. Push the switch to the second position to operate only the headlights. Push the switch back to the first position to turn off all lights.



Push the switch to the third position to operate the headlights and allow use of the overhead work lights and rear fog lights.

NOTE: The rear fog light and overhead work light switches must be in the on position for the lights to function.



OVERHEAD WORK LIGHT SWITCH

Use the *Overhead work light switch* to operate the overhead work lights. The *Master light switch* must be in the third position to operate the overhead work lights.



REAR FOG LIGHT SWITCH

Use the *Rear fog light switch* to operate the rear fog lights. The *Master light switch* must be in the third position to operate the rear fog lights.



CAB TEMPERATURE CONTROL KNOB

Turn the *Cab temperature control knob* clockwise to increase the temperature and counterclockwise to decrease the temperature inside the cab when the heater is on.



HEATER FAN SWITCH

Use the 2-speed *Heater fan speed switch* to operate / adjust the heater fan.



AIR CONDITIONER (OPTION)

Use the 2-speed *Air conditioner fan speed switch* to operate / adjust the air conditioner fan.

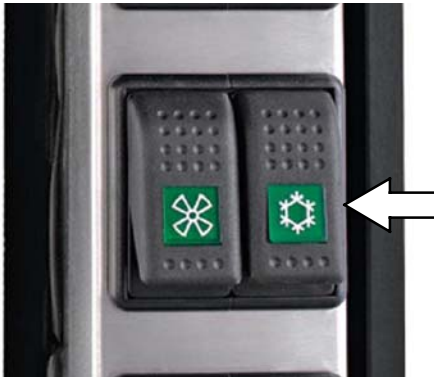

4-WAY WARNING LIGHT SWITCH

Use the 4-way *warning light switch* to operate the 4-way warning lights.



WARNING BEACON / AUDIBLE ALARM SWITCH

Use the 3-position *Warning beacon / audible alarm switch* to activate the warning beacon and audible alarm. Push the switch to the second (middle) position to operate only the warning beacon.



Push the switch to the third (lower) position to operate both the warning beacon and audible alarm. Push the switch back to the first position to turn off the warning beacon and audible alarm.



The warning beacon can be swung back behind the cab to allow for lower clearances.

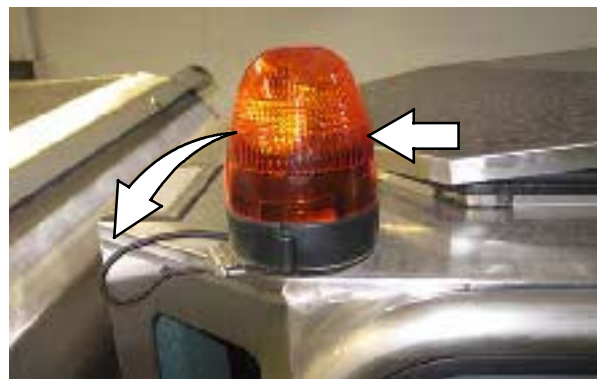

OPERATION

WATER SWITCH (DUST SUPPRESSION)

Turn the water switch to position 0 in areas where dust suppression is not necessary. Neither the brush head spray jets nor the vacuum tube spray jets operate in this mode. The CloudMaker nozzle continues to rotate to keep the spray head clean, but does not use water.



Turn the water switch to position 2 in areas where some dust suppression (wet sweeping) is necessary. Only the brush head spray jets and vacuum tube spray jets operate in this mode. The CloudMaker nozzle continues to rotate to keep the spray head clean, but does not use water.



Turn the water switch to position 1 for dry areas where full dust suppression is necessary. The CloudMaker nozzle, brush head spray jets, and vacuum tube spray jet operate in this mode.



WATER FLOW CONTROL KNOB

Turn the *Water flow control knob* clockwise to decrease the amount of water supplied to the brush jets and counterclockwise to increase the amount of water to the brush jets.

NOTE: To operate only the CloudMaker and conserve water, turn the water switch to position 1 and the water flow control knob to the minimum flow setting to turn off the water to the brush spray jets.



BRUSH PRESSURE ADJUSTMENT KNOB

To adjust the brush pressure, loosen the lock ring under the *Brush pressure adjustment knob*. Turn the knob counterclockwise to decrease the brush pressure and clockwise to increase the brush pressure. Retighten the lock ring.



PARKING BRAKE LEVER

Pull the *Parking brake lever* to engage the parking brake. Slightly lift the *Parking brake lever*, press the button, and completely lower the lever to disengage the parking brake.



ACCELERATOR PEDAL

Press the *Accelerator pedal* to move the machine.

NOTE: The accelerator pedal is very responsive to pressure. Press the pedal slowly to move the machine. Releasing the pedal will cause the machine to slow down.



BRAKE PEDAL

Press the *Brake pedal* to stop the machine.



OPERATION

STEERING WHEEL HEIGHT ADJUSTMENT HANDLE

1. Loosen the *Steering wheel height adjustment handle* and adjust the steering wheel to the desired height.
2. Tighten the *Steering wheel height adjustment handle* to secure the steering column / steering wheel into place.



WINDSHIELD WIPER / WASHER SWITCH

Turn the outer ring to activate the windshield wipers. Press the outer ring to activate the windshield washer.



HORN BUTTON

Push the horn button located at the end of the switch to sound the horn.



HEADLIGHT AND MULTIFUNCTIONAL SWITCH

Parking and Headlights On: Rotate the knob clockwise.

Parking Lights On: Rotate the knob to the first click.

Headlights On: Rotate the knob to the second click.

Bright Headlights On: Push the lever down.

Bright Headlights Off: Pull the lever up.

Flash Bright Headlights: Pull the lever up, then release.

Signals: Push the lever forward for the right signal. Pull the lever back for the left signal.



OPERATOR SEAT

The operator seat has four adjustments: backrest angle, seat tilt, operator weight, and front to back.

The front-to-back adjustment lever adjusts the seat position.



The backrest and seat tilt adjustment knobs adjust the angle of the backrest and seat.



The weight adjustment knob controls the firmness of the operator seat.



SEAT BELTS

FOR SAFETY: Before starting machine, adjust seat and fasten seat belt.



DOOR LOCKS

The cab doors can be locked from either inside or outside the cab.

Outside cab: Use the key to lock and unlock the door.



Inside cab: Move the lever up to lock the door. Move the lever down to unlock the door.

NOTE: Doors locked from the inside cannot be unlocked from the outside using a key. Ensure that the door(s) are unlocked before closing the cab door.



OPERATION

BRUSH INFORMATION

For best results, use the correct brush type for the cleaning application.

NOTE: The amount and type of soilage play an important role in determining the type of brushes to use. Contact an authorized service representative for specific recommendations.

Polypropylene Brush – Best overall general cleaning brush. The bristles fan out and dig into cracks to remove debris.

Polypropylene and Wire Brush – Recommended for moving heavy debris. Best bristle mix for moving large quantities of sand and heavier debris. The bristles fan out similar to the polypropylene brush. The wire bristles provide the ability to move heavier material.

PET (Polyethylene Terephthalate) Heavy Duty Brush – Recommended for areas where there is a heavy build up of debris. The stiffer / thicker bristles provide more aggressive digging action to remove compacted debris from along buildings, curbs, and in corners.

HOW THE MACHINE WORKS

The two front brushes move debris to the center of the machine and the vacuum pulls the debris into the hopper. The airflow must be maintained through the machine to keep it functioning properly.

The air and debris swirl in a cyclonic rotation inside the hopper. The dust and debris drops to the bottom of the hopper and the air exits through vents at the rear of the machine. Screens located in the hopper prevent light debris (leaves, paper, etc...) from exiting the hopper and the cyclone assemblies located at the top of the hopper prevent dust particles from exiting the hopper.



PRE-OPERATION CHECKLIST

Raise the hopper and engage the hopper safety arm before performing the pre-operation checks. See the *RAISING / LOWERING THE HOPPER* section of this manual.



**WARNING: Raised hopper may fall.
Engage hopper safety arm.**

FOR SAFETY: Before leaving or servicing machine, stop on level surface, place drive lever in neutral, set parking brake, turn off machine, and remove key from ignition.

*NOTE: **Do Not** unlock the hopper lid latches when raising the hopper for pre-operation checks.*

- Check the engine coolant level.
- Check the windshield washer fluid level.
- Check the air filter indicator.
- Check the engine oil level.
- Check the hydraulic fluid level.
- Check the water tank level.
- Check the condition of the brushes. Remove any string, banding, plastic wrap, or other debris from the brushes.
- Check the vacuum head height and side skids.
- Check tire pressure and condition of tires.
- Check operating lights (headlights, taillights, work lights, rotating beacon, and hazard warning lights).
- Check safety equipment.
- Ensure all panels are secured in place.
- Check the fuel level.
- Ensure all controls, gauges, and indicators function properly.

POST OPERATION CLEANING

Completely clean the machine after every use. Raise the hopper and engage the hopper safety arm before cleaning the hopper and the engine compartment. See the *RAISING / LOWERING THE HOPPER* section of this manual.



**WARNING: Raised hopper may fall.
Engage hopper safety arm.**

FOR SAFETY: Before leaving or servicing machine, stop on level surface, place drive lever in neutral, set parking brake, turn off machine, and remove key from ignition.

- Empty the hopper.
- Clean the interior of the hopper.
- Clean the engine compartment and around the hydraulic components.
- Clean the area surrounding the water pump and the bottom corners of the radiator.
- Clean the brushes and vacuum head area.
- Clean the vacuum fan assembly.

OPERATION

STARTING THE MACHINE

FOR SAFETY: Do not operate machine, unless operator manual is read and understood.

*NOTE: Watch / listen for visual and audible warnings from the MDM (Machine Display Module) system while operating the machine. **Do not** operate the machine until all warnings have been corrected. See MACHINE DISPLAY MODULE (MDM) FAULT SCREENS section of this manual.*

1. Sit in the operator seat, press the brake pedal or set the parking brake, and place the drive lever into neutral.

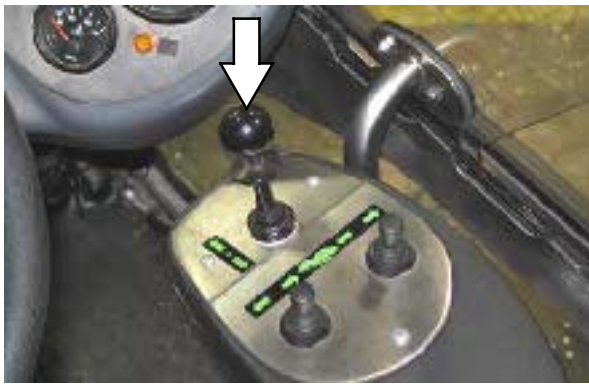

FOR SAFETY: When starting machine, keep foot on brake and drive lever in neutral.

2. Turn the key clockwise until the *glow plug indicator* comes on, but not far enough to start the engine. Hold the key in this position for 5 seconds, depending on temperature. Colder temperatures require longer time.



3. Turn the key further clockwise to start the engine.

NOTE: Do not operate the starter motor for more than 10 seconds at a time or after the engine has started. Allow the starter to cool 15-20 seconds between starting attempts or damage to the starter motor may occur.

4. Allow the engine and hydraulic system to warm up for three to five minutes.



WARNING: Machine emits toxic gases. Severe respiratory damage or asphyxiation can result. Provide adequate ventilation. Consult with your regulatory authorities for exposure limits. Keep engine properly tuned.

TURNING OFF THE MACHINE

1. Stop the machine, turn off all sweeping functions, and place the drive lever into the neutral (middle) position.
2. Wait several seconds for the vacuum fan to completely stop rotating.

NOTE: If the engine is turned off before the vacuum fan stops rotating, the vacuum fan brake will engage and emit a very loud noise as it stops the fan.

3. Turn the ignition switch key counter clockwise to turn off the machine. Remain in the operator seat until the engine is off.

FOR SAFETY: Before leaving or servicing machine, stop on level surface, place the drive lever in neutral, set parking brake, turn off machine, and remove key from ignition.

WHILE OPERATING THE MACHINE

Perform the Pre-Operation Procedures before each use (see *MACHINE MAINTENANCE* section of this manual).

Avoid bulky debris such as crates, boxes, tree branches, and heavy material. Avoid straps, twine, rope, etc., that could become entangled in the brushes.

Plan the sweeping in advance. Try to arrange long runs with minimum stopping and starting. Sweep as straight a path as possible. Overlap the brush paths. Use dust suppression in dusty conditions.

Avoid turning the steering wheel too sharply when the machine is in motion. The machine is very responsive to the movement of the steering wheel. Avoid sudden turns, except in emergencies.

If poor sweeping performance is observed, stop cleaning and refer to *MACHINE TROUBLESHOOTING* section of this manual.

Drive the machine slowly on inclines. Use the brake pedal to control machine speed on descending inclines. Sweep with the machine up inclines rather than down inclines.

Never maneuver over curbs with the brushes and nozzle down. Always raise the brushes and nozzle prior to moving over curbs. Never drive over curbs at a high speed or at a 90° angle. Approach curbs at approximately a 45° angle.

In rare circumstances one wheel may lose traction when moving over curbs due to uneven weight distribution. The machine automatically provides traction to prevent the vehicle from coming to a stop due to one wheel losing traction when the machine is in work mode 2.

FOR SAFETY: When using machine, go slow on inclines and slippery surfaces.

Maximum rated climb and descent for a full hopper is 9°/20%.

OPERATION

SWEEPING

FOR SAFETY: Do not operate machine, unless operator manual is read and understood.

1. Start the machine.
2. Place the *Transit / Work mode switch* into work mode 1 (middle position) for sweeping.



3. Turn the *Water switch* to the appropriate mode for sweeping conditions.



4. Adjust the brush speed and vacuum fan speed knobs and the brush pressure adjustment knob for sweeping conditions.

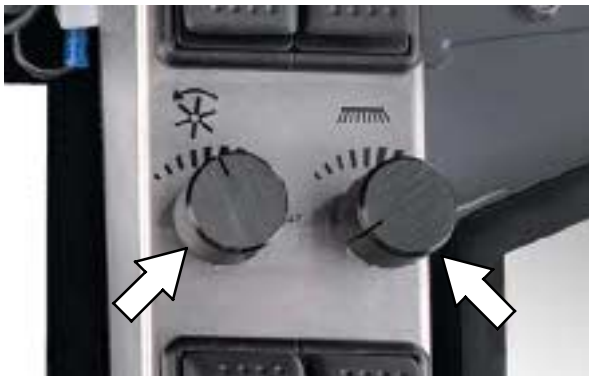

5. Adjust the brush pressure adjustment knob for sweeping conditions.



6. Place the *Drive lever* into the forward position.



7. Release the parking brake, then press the *Accelerator pedal* to begin sweeping.

FOR SAFETY: When using machine, go slow on inclines and slippery surfaces.

- Adjust the brush path. If there is a trail of debris not being picked up by the machine, narrow the sweeping path.



NOTE: The brush path width can be widened so the machine can clean along curbs without the tires rubbing against the curb and narrowed so the machine can sweep in hard to reach areas.

- Activate the hopper drain if sweeping in wet areas or through standing water.



- To stop sweeping, press the *Brake pedal* to stop the machine.
- Turn off all sweeping functions.
- Empty the debris hopper at the end of each shift or as needed. See *EMPTYING THE HOPPER* section of this manual.

DRIVING OVER CURBS

- Stop the machine.
- Place the machine into work mode 2 to raise the brushes and spray nozzle.

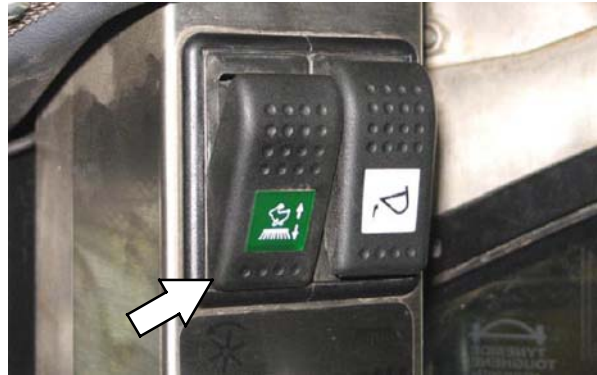

- Approach the curb at approximately a 45° angle and slowly drive over the curb.



- Return the machine to either work mode 1 or transit mode.

RAISING / LOWERING THE HOPPER

1. Ensure the rear water tank door is closed.
The water tank could be damaged if the door is left open.
2. Set the parking brake and place the *Drive lever* into neutral.
3. Place the machine into either work mode 1 or work mode 2 to increase the engine rpm.

FOR SAFETY: When using machine, make sure adequate clearance is available before raising hopper.

4. Press and hold the top of the *Hopper raise / lower switch* to raise the hopper.



5. Press and hold the bottom of the *Hopper raise / lower switch* to lower the hopper.



ENGAGING THE HOPPER SAFETY ARM

The hopper safety arm prevents the raised hopper from falling. Always engage the hopper safety arm whenever leaving the hopper raised.

1. Set the parking brake and place the drive lever in neutral.
2. Start the machine.
3. Place the machine in work mode 1 or work mode 2.



4. Press and hold the top of the *Hopper raise / lower switch* to completely raise the hopper.



WARNING: Lift arm pinch point. Stay clear of hopper lift arms.

FOR SAFETY: When using machine, make sure adequate clearance is available before raising hopper.

5. Lift the hopper safety arm from the storage clip and prop it up against the hopper.



WARNING: Raised hopper may fall. Engage hopper safety arm.

6. Turn off the machine.

OPERATION

DISENGAGING THE HOPPER SAFETY ARM

1. Start the machine.
2. Be sure the machine is in work mode 1 or work mode 2, the drive lever is in neutral, and the parking brake is engaged.
3. Lower the hopper safety arm into the storage clip.



4. Press and hold the bottom of the *Hopper raise / lower switch* to lower the hopper.



 **WARNING:** Lift arm pinch point. Stay clear of hopper lift arms.

USING THE WANDER HOSE

 **WARNING:** Accident may occur. Do not operate wander hose while driving.

1. Stop the machine, place the drive lever into neutral, and set the parking brake.
2. Raise the hopper. See RAISING / LOWERING THE HOPPER section of this manual for additional information.
3. Locate the hopper inlet blanking plate and place on to the vacuum port.



4. Remove the wander hose from the top of the hopper.
5. Lower the hopper and turn off the machine. See RAISING / LOWERING THE HOPPER section of this manual for additional information.

FOR SAFETY: Before leaving or servicing machine, stop on level surface, place drive lever in neutral, set parking brake, turn off machine, and remove key from ignition.

6. Open the wander hose access door to access the vacuum adapter cover.

- Open the vacuum adapter cover and attach the *wander hose* to the adapter.

NOTE: Take care when unlatching the wander hose vacuum adapter cover latches. The latches are spring loaded.



- Start the machine.



WARNING: Machine emits toxic gases. Severe respiratory damage or asphyxiation can result. Provide adequate ventilation. Consult with your regulatory authorities for exposure limits. Keep engine properly tuned.

- Place the *Transit / Work mode* switch into the work mode 1 (middle) position.



- Press the bottom of the *wander hose switch* to start the vacuum.



- Adjust the vacuum fan speed knob for cleaning conditions.



- Use the wander hose for cleaning.

NOTE: If the wander hose becomes blocked, carefully squeeze along the entire length of hose until the blockage is found. Carefully squeeze the blocked area until the obstruction breaks loose.

- When through using the wander hose, press the top of the wander hose switch to turn off the vacuum. Shut off the machine.
- Remove the wander hose from the adapter. Secure the vacuum adapter cover over the adapter opening and close the access doors.
- Start the machine and raise the hopper. Secure the wander hose onto the top of the hopper. Remove the hopper inlet blanking plate. Lower the hopper.

OPERATION

EMPTYING THE HOPPER

1. Drive the machine to the debris site, stop the machine, place the drive lever into neutral, and set the parking brake.

FOR SAFETY: Before leaving or servicing machine, stop on level surface, place drive lever in neutral, and set parking brake.

2. Ensure the water tank door is closed. The water tank could be damaged if the door is left open.
3. Unlock and open both hopper lid latches.



NOTE: Both hopper lid latches must be unlocked and open to empty debris from the hopper.

4. Place the machine into either work mode 1 or work mode 2 to increase the engine rpm.

FOR SAFETY: When using machine, make sure adequate clearance is available before raising hopper.

5. Press and hold the top of the *Hopper raise/ lower switch* to raise the hopper and empty debris.

NOTE: If necessary, use the scraper stored inside the left access door to remove debris from the hopper. See CLEANING THE MACHINE section of this manual.



6. Press and hold the bottom of the *Hopper raise / lower switch* to lower the hopper.



7. Close and secure both hopper lid latches.

CLEANING THE MACHINE

1. Stop the machine, place the *Drive lever* into neutral, and set the parking brake.

FOR SAFETY: Before leaving or servicing machine, stop on level surface, place drive lever in neutral, and set parking brake.

2. Ensure the water tank door is closed. The water tank could be damaged if the door is left open.
3. Unlock and open hopper lid latches.



4. Place the machine into either work mode 1 or work mode 2 to increase the engine rpm.

FOR SAFETY: When using machine, make sure adequate clearance is available before raising hopper.

5. Press and hold the top of the *Hopper raise / lower switch* to raise the hopper.



! WARNING: Lift arm pinch point. Stay clear of hopper lift arms.

6. Turn off the machine and remove the key.

FOR SAFETY: Before leaving or servicing machine, turn off machine and remove key from ignition.

7. Engage the hopper safety arm.



! WARNING: Raised hopper may fall. Engage hopper safety arm.

8. Remove the side panels from the machine and set the panels aside in a safe area.
9. Clean the vacuum port.



OPERATION

10. Clean the radiator screen and engine compartment.

NOTE: Do Not run the engine when cleaning the engine and engine compartment with water. The engine could be damaged if it is left running while cleaning. The warranty will be invalidated if the engine is damaged due to water entering it while cleaning.



11. Carefully clean the area around hydraulic tank and components.

NOTE: Do Not spray the hydraulic filter. The hydraulic system could be damaged if water enters system while cleaning. The warranty will be invalidated if hydraulic system is damaged due to water entering the system while cleaning.



12. Clean the interior of the hopper, hopper screen, hopper cyclones, and suction tube. If necessary, use the scraper stored inside the left access door to to loosen / remove stuck debris.



WARNING: Do not spray people or animals. Severe personal injury can result. Wear eye protection. Hold sprayer with two hands.



13. Disengage the hopper safety arm.



14. Reinstall the side panels onto the machine.

15. Start the machine and press the bottom of the *Hopper raise / lower switch* to lower the hopper.



WARNING: Lift arm pinch point. Stay clear of hopper lift arms.

16. Disconnect the water tank door retainer chain from the bracket.



17. Pull the safety pin from the rear bumper, pull the handle, and open the water tank door.



18. Clean the area surrounding the water pump and the bottom corners of the radiator.



NOTE: Do not use excessive water pressure when cleaning the radiator and areas around the radiator. Excessive water pressure could damage the radiator.

OPERATION

19. Close and secure the water tank door. Attach the water tank door retainer chain to the bracket.
20. Clean the brushes and vacuum head area.



21. Clean the rest of the machine as necessary.

CLEANING THE VACUUM FAN ASSEMBLY

FOR SAFETY: Before leaving or servicing machine, stop on level surface, place drive lever in neutral, set parking brake, turn off machine, and remove key from ignition.

1. Turn machine off and allow the vacuum fan to come to a complete stop.

NOTE: Do Not attempt to stop the vacuum fan with hands, scraper, or other objects.

2. Use the access key to unlock and open the vacuum fan access door.



3. Remove the scraper from the storage area inside the left access door.

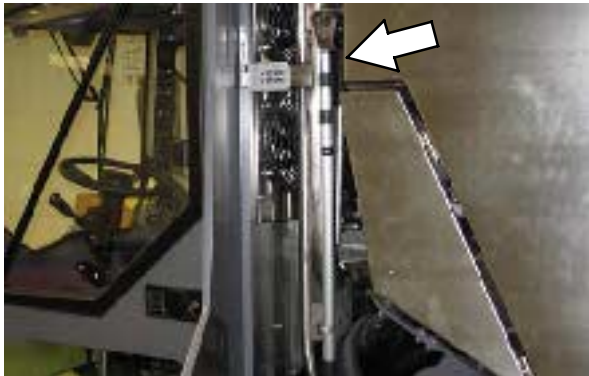

4. Use the scraper to scrape debris from the vacuum fan assembly.



5. Use pressurized water to clean the vacuum fan assembly.

! WARNING: Do not spray people or animals. Severe personal injury can result. Wear eye protection. Hold sprayer with two hands.

6. When through cleaning the vacuum fan assembly, close and secure the vacuum fan access door. Return the scraper and access key to the appropriate storage locations.

NOTE: Do Not lose the vacuum fan access door access key. Return the access key to the appropriate storage location immediately after use. The vacuum fan access door cannot be opened without the access key.

CHECKING / FILLING THE WATER TANK

FOR SAFETY: Before leaving or servicing machine, stop on level surface, place drive lever in neutral, set parking brake, turn off machine, and remove key from ignition.

1. Check the water tank level at the water tank level tube. If necessary, fill the water tank.

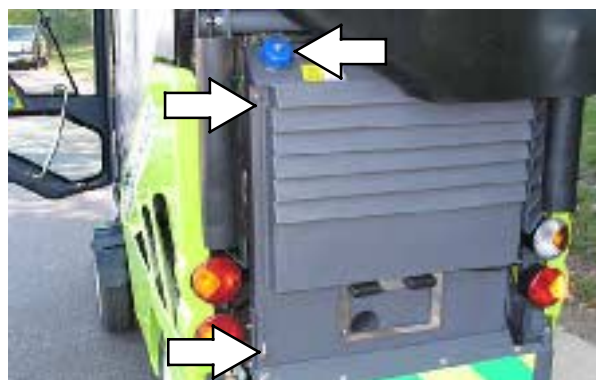

OPERATION

USING THE MACHINE DISPLAY MODULE (MDM) SYSTEM

The Machine Display Module (MDM) displays the current machine operating status (operation mode, drive lever position, engine rpm, fan speed, and the speed of the machine when it is in the transit mode).



2. Press the UP or DN (down) buttons to select the engine speed (between 1200 and 2800 rpm).



3. Press the F1 (OK) button to confirm the new speed.

If necessary, press the F2 (Cancel) button to set the engine back to the previous speed.

ADJUSTING THE ENGINE SPEED

NOTE: For normal operating conditions the engine speed should be set between 2100 and 2300 rpm.

FOR SAFETY: When using machine: Do not make adjustments on Machine Display Module (MDM) System while the machine is moving. Always stop machine before making adjustments.

1. Press the F1 select button.



If necessary, press the F3 (Reset) button to reset the engine to the default speed (2200 rpm).



USING THE ENGINE SPEED BOOST

When sweeping uphill it may be necessary to increase the engine speed to obtain more power. Engine speed boost (engine speeds above 2600 rpm) is available for only three 10-minute intervals per hour. An audible alarm will sound at the end of the ten minutes and the engine will automatically reset to 2600 rpm.

1. Stop the machine, press and hold the brake pedal, and place the drive lever into neutral.

FOR SAFETY: When using machine: Do not make adjustments on Machine Display Module (MDM) System while the machine is moving. Always stop machine before making adjustments.

2. Press the UP button to increase the engine speed to above 2600 rpm. A countdown bar appears on the MDM display.



3. Place the *drive lever* into the forward position and press the *accelerator pedal* to continue sweeping.
4. When finished using the engine speed boost, stop the machine and place the drive lever into neutral.
5. Reset the engine to the normal operating range.

OPERATION

MACHINE DISPLAY MODULE (MDM) FAULT SCREENS

The Machine Display Module (MDM) displays all operation faults.



Operation faults are also accompanied by an audible alarm to alert the operator a fault has occurred.

Refer to the table below to determine the cause and remedy for the fault.

MDM Code	Cause(s)	Remedy
Warning Fan Running For Whoosh Hose- Caution Required	Wander (whoosh) hose fan is operating.	Shut off wander (whoosh) hose.
Warning Fan Access Door Open	Fan access safety door is open or there is a break in switch circuit.	Shut off machine. Close vacuum fan access door. Call authorized service representative if there is a break in switch circuit.
Warning Liquid Level Sensor, Water Spray Pump-Check Connection	Electrical Fault.	Shut off machine. Call authorized service representative.
Warning Forward Trans Pressure Sensor-Check Connection	Electrical Fault.	Shut off machine. Call authorized service representative.
Warning Engine Oil-Low Pressure	Engine oil pressure is low.	Shut off machine. Add engine oil.
Warning Engine Temperature High-Stop Engine	Engine temperature above 115° C (239° F).	Shut off machine. Call authorized service representative.
Warning Engine Coolant Level Low-Stop Engine	Engine coolant level in expansion tank falls below minimum level.	Shut off machine. Add coolant.
24 Hour Warning Air Filter Minder- Maintenance Required	Engine air intake problem.	Shut off machine. Replace air filter and reset filter minder.
Warning Hyd. Oil Temperature High-Stop Vehicle	Hydraulic fluid temperature reaches 95° C (203° F).	Shut off machine. Call authorized service representative.
Warning Park Brake On-Release Park Brake	Parking brake is engaged.	Release parking brake.

MDM Code	Cause(s)	Remedy
Warning Transmission Disabled- Return To Neutral	Drive lever is in forward or reverse positions when engine is started.	Return drive lever to neutral position.
Fan Hi-Speed Booster Timer 100	Fan speed is above 2400 rpm.	Fan automatically shuts off after 5 minutes.
Engine Hi-Speed Booster Timer 100	Engine speed is above 2600 rpm.	Engine automatically reduced to under 2600 rpm after 10 minutes.
Fan Boost 100 Engine Boost 100	Fan speed is above 2400 rpm. Engine speed is above 2600 rpm.	Fan automatically shuts off after 5 minutes. Engine automatically reduced to under 2600 rpm after 10 minutes.
Vac Fan Boost Exceeded Vac Fan Boost Not available-Reduce To <2400 RPM-Max 5 Boost Per Hour	More than 5 fan boosts activated per boost period.	No additional boosts allowed within hour of first boost.
Engine Boost Exceeded Engine Boost Not Available-Reduce To <2600 RPM-Max 3 Boost Per Hour	More than 3 engine boosts activated per boost period.	No additional boosts allowed within hour of first boost.
Warning (Work) Check Wheel Speed Sensor- Feed Back To MDM Not Correct	Vehicle speed sensor is outside normal operating range when machine is in work mode.	Shut off machine. Call authorized service representative.
Warning (Trans) Check Wheel Speed Sensor-Feed Back To MDM Not Correct	Vehicle speed sensor is outside normal operating range when machine is in transit mode.	Shut off machine. Call authorized service representative.
Warning Check Wheel Speed Sensor Feed Back is <800 RPM Or >3100 RPM	Frequency input equating to less than 800 rpm or more than 3100 rpm.	Shut off machine. Call authorized service representative.
Warning Vacuum Fan Is Off Or The Speed Sensor is Faulty. Check Vacuum Speed Sensor	In work mode 1 and forward drive, but fan speed is less than 100 rpm or more than 3100 rpm.	Shut off machine. Call authorized service representative.
Caution Speed Restriction Wheel Track Operating	Tracking has started, but has not been completed.	Allow tracking to complete.
24 Hour Warning CloudMaker Running Slow Water Switch Move To RHS	CloudMaker maker switched on, but speed is 1000 rpm or less (designed speed is 17000 rpm).	Shut off machine. Call authorized service representative.
Warning Hopper Raised Lower Hopper	Hopper is raised.	Lower hopper.
Warning Both Tacking Sensors On Check Sensors on Axle	Both tracking sensors are on.	Shut off machine. Call authorized service representative.
Warning Hydraulic Oil Level-Low Stop Engine	Not enough hydraulic fluid for machine to operate safely.	Shut off machine. Add hydraulic fluid.
Warning Track Wheels In For Full. Fan And Brushes On	Wheels tracked out when machine is in work mode 1 / forward.	Shut off machine. Call authorized service representative.

OPTIONS

PRESSURE WASHER (OPTION)

FOR SAFETY: When using pressurized air or water, wear eye and ear protection.

1. Stop the machine, place the drive lever into neutral, turn off the engine, and set the parking brake.

NOTE: Pressure washer will not function if the parking brake is not engaged.

FOR SAFETY: Before leaving or servicing machine, stop on level surface, place drive lever in neutral, set parking brake, and turn off machine.



2. Check the water tank level. **Do Not** operate the pressure washer if the water tank is low or empty.
3. Remove the pressure washer wand from the brackets, and pull the pressure washer hose completely out from the reel.



4. Start the machine.



WARNING: Engine emits toxic gases. Severe respiratory damage or asphyxiation can result. Provide adequate ventilation. Consult with your regulatory authorities for exposure limits. Keep engine properly tuned.

5. Place the *Work mode switch* into the work mode 1 (middle) position.



6. Press the bottom of the *Pressure washer switch* to start the pressure washer pump.



7. Hold the wand with both hands, point the wand towards the ground, and squeeze the trigger.



WARNING: Do not spray people or animals. Severe personal injury can result. Wear eye protection. Hold sprayer with two hands.

8. Use the wand to clean.

NOTE: Do not run the pressure sprayer pump for sustained periods if not using the power wand. The pressure sprayer pump could be damaged from overheating if allowed to run for sustained periods when the wand is not in use.

9. Release the trigger when through cleaning and set the wand down.
10. Press the top of the pressure washer switch to turn off the pump. Shut off the machine.
11. Hold the wand with both hands and point the wand towards the ground. Squeeze the trigger to release pressure from the system.
12. Wind the pressure washer hose back onto the reel. Return the pressure washer wand to the storage brackets. Close the access door.

REAR VIEW CAMERA (OPTION)

Use the *Rear view camera* to watch areas behind the machine when backing up the machine. Refer to the rear view camera manual for operation instructions.

RADIO AND COMPACT DISK PLAYER (OPTION)

The *radio and compact disk player* is located above the operator. Refer to the radio/compact disk player manual for operation instructions.

AUTOMATIC GREASING (OPTION)

The *Automatic greasing system* automatically dispenses grease to all grease points. A green indicator light located on the reservoir top cover illuminates when the automatic greasing system is operating.

Press the TEST button daily to ensure the automatic greasing system is operating. The motor will start and the paddle will rotate once in approximately three minutes and then reset to the default one rotation for every 12 minutes. The pump cycle time of 12 minutes is not adjustable.

FILLING THE AUTOMATIC GREASING SYSTEM RESERVOIR

FOR SAFETY: Before leaving or servicing machine, stop on level surface, place drive lever in neutral, set parking brake, turn off machine, and remove key from ignition.

1. Remove the cap from the automatic greasing system reservoir.
2. Pour grease into the automatic greasing system reservoir.
3. Reinstall the cap onto the automatic greasing system reservoir.

OPERATION

WINTER EQUIPMENT (OPTION)

The 636 can be fitted with a front snow brush, front straight plow, blade front V plow blade, and a rear grit dispenser for clearing snow.

SNOW BRUSH (OPTION)

FOR SAFETY: Do not operate machine, unless operator manual is read and understood.

1. Start the machine.
2. Place the *Transit / Work mode switch* into work mode 1 (middle position) for sweeping.



3. Press the bottom of the *Snow brush switch* to start the brush.



4. Use the vacuum fan speed knob to adjust the snow brush speed.



5. Place the *Drive lever* into the forward position.



6. Release the parking brake, then press the *Accelerator pedal* to begin brushing snow.

FOR SAFETY: When using machine, go slow on inclines and slippery surfaces.

7. To stop brushing snow, press the *Brake pedal* to stop the machine.
8. Turn off all snow brush functions.

SNOW PLOWS (OPTION)

FOR SAFETY: Do not operate machine, unless operator manual is read and understood.

1. Start the machine.
2. Place the *Transit / Work mode switch* into work mode 1 (middle position) for sweeping.



3. Use the *Brush levers* to adjust the path of the plow.

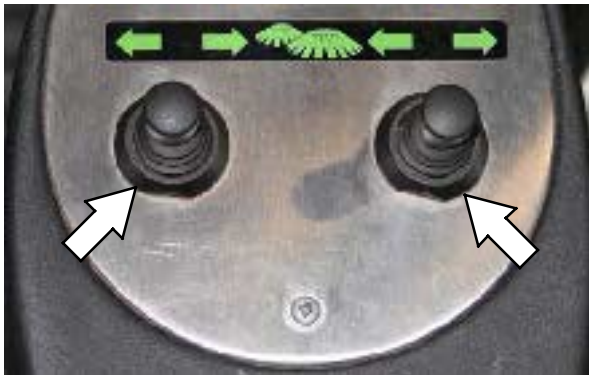

4. Place the *Drive lever* into the forward position.



5. Release the parking brake, then press the *Accelerator pedal* to begin plowing snow.

FOR SAFETY: When using machine, go slow on inclines and slippery surfaces.

6. To stop plowing snow, press the *Brake pedal* to stop the machine.
7. Turn off all plow functions.

OPERATION

GRIT (SAND / ROAD SALT) DISPENSER (OPTION)

FOR SAFETY: Do not operate machine, unless operator manual is read and understood.

NOTE: The rear grit dispenser can be used when operating the snow brush or plow.

1. Start the machine.
2. Place the *Transit / Work mode switch* into work mode 1 (middle position).



3. Press the bottom of the *Grit dispensing switch* to start dispensing grit.



4. Use the brush speed knob to adjust the rate at which the grit is being dispensed.



5. Place the *Drive lever* into the forward position.



6. Release the parking brake, then press the *Accelerator pedal* to begin dispensing the grit.

FOR SAFETY: When using machine, go slow on inclines and slippery surfaces.

7. To stop dispensing grit, press the *Brake pedal* to stop the machine.
8. Press the top of the *Grit dispensing switch* to turn off the grit dispenser.



MACHINE TROUBLESHOOTING

Problem	Cause	Remedy
Excessive dusting	Vacuum fan speed knob turned off or set too low	Adjust vacuum fan speed knob for sweeping conditions
	Dust suppression system not on	Turn on dust suppression system
	Vacuum hose damaged	Replace vacuum hose
	Vacuum fan seal damaged	Replace vacuum fan seal
	Vacuum fan failure	Call authorized service representative
Poor sweeping performance	Vacuum fan speed too low for conditions	Increase vacuum fan speed
	Debris caught in front vacuum hose	Clear debris from vacuum hose
	Hopper is full	Empty hopper
	Front nozzle is set too high	Adjust height of front nozzle
	Blockage in vacuum fan system	Clear debris from vacuum fan system
	Machine moving too fast for conditions	Decrease speed
	Cyclones blocked	Clear debris from cyclones
	Worn brush bristles	Replace brushes
	Brush pressure set too light	Increase brush pressure
	Brushes not properly adjusted	Adjust brushes
	Debris caught in brush drive mechanism	Remove debris from brush drive mechanism
	Brush drive failure	Call authorized service representative
	Improper brushes	Refer to <i>Brush Information</i> or call authorized service representative
	Brush sweep path is too wide	Narrow sweeping path
Brushes bouncing	Brushes set too low	Adjust height of brushes
	Brush speed too low in relation to speed of machine	Adjust brush speed
Dust suppression system not operating (no mist from CloudMaker)	Machine not in work mode 1	Place machine in work mode 1
	Pump is not on	Turn on pump
	Water control knob not set to correct position for sweeping conditions	Adjust water control knob for sweeping conditions
	Water liquid level sensor dirty / inoperable	Clean water liquid level sensor if dirty. Call authorized service representative if water liquid sensor is inoperable
	Water tank is empty	Fill water tank
	Blocked jet in line filter	Clear blockage from jet in line filter
	Blocked jet	Clear blockage from jet
	Pump vacuum tube disconnected at tank drain tube	Reconnect pump vacuum tube to tank drain tube
	Blocked tank vacuum strainer	Clear debris from tank vacuum strainer
	Defective water pump	Call authorized service representative

OPERATION

Problem	Cause	Remedy
Excessive vibration while sweeping	Debris caught in / blocking fan casing	Remove debris caught in / blocking the fan casing
	Vacuum fan impeller damaged	Call authorized service representative
Hydraulic fluid overheating	Hydraulic fluid level is low	Add hydraulic fluid to hydraulic system
	Incorrect hydraulic fluid in system	Drain old hydraulic fluid from system and refill system with correct hydraulic fluid
	Radiator dirty or blocked	Clean / clear debris from radiator
	Radiator screen is blocked	Clear debris from radiator screen
	Fan belt damaged / incorrectly adjusted	Replace / adjust fan belt
Engine will not start / turn over	Dead battery	Recharge battery
	Battery cable connections loose	Tighten battery cable connections
Engine overheating	Radiator / coolant system blocked	Clear blockage
	Radiator fins damaged	Call authorized service representative
	Engine compartment not adequately cleaned	Clean engine compartment
	Engine coolant level is low	Add coolant to reservoir
	Incorrect coolant is being used	Drain coolant and replace with correct coolant / coolant mix
	Radiator screen blocked	Remove debris from radiator screen
	Fan belt damaged / incorrectly adjusted	Replace / adjust fan belt
Engine smoking	Black smoke - Dirty air filter	Replace air filter
	Blue smoke - Burning oil	Call authorized service representative
	White smoke / mist / steam - Leaking head gasket	Call authorized service representative
	Black or blue smoke, inadequate power - Faulty turbo	Call authorized service representative
	Incorrect fuel in fuel tank	Call authorized service representative
Front wheel spinning on uneven surface	Machine is in work mode 1 or transit mode	Place machine into work mode 2

CONDITIONS TABLE

The table below explains conditions that must be met before certain operational functions will work. Understanding how the different operational functions work together will help the operator more efficiently utilize the machine.

Function	Conditions											Foot-notes	
	Engine Running	Mode Switch			Drive Switch			Hopper Position	Park Brake	Axle Tracking	Maximum Fan Speed		Additional Conditions
		Transit	Work 1	Work 2	FWD	N	REV						
Hopper RAISE	X		X	X		X					50 rpm	Hopper Raise / Lower Switch: RAISE	(1)
Hopper LOWER	X	X	X	X		X						Hopper Raise / Lower Switch: LOWER	
Tracking OUT	X	X			X			DOWN	OFF			Accelerator Pedal: Depressed Speed: Above 5 km/h (3 mph)	
Tracking IN	X		X	X	X			DOWN	OFF			Accelerator Pedal: Depressed Speed: Above 5 km/h (3 mph)	
Work Mode 1	X		X		X			DOWN	OFF	IN		Accelerator Pedal: Depressed Speed: Up to 12 km/h (7.5 mph)	
Work Mode 2	X			X	X			DOWN	OFF	IN		Accelerator Pedal: Depressed Speed: Up to 16 km/h (10 mph)	
Transit Mode	X	X			X			DOWN	OFF	OUT		Accelerator Pedal: Depressed Speed: Up to 32 km/h (20 mph)	(2)
Brushes ON	X		X		X					IN		(3)	(4)
Vacuum Fan ON	X		X		X			DOWN		IN	2700 rpm	Fan Door: CLOSED (12)	
Brushes IN/OUT	X		X		X					IN			
Brushes/Nozzle UP	X	X	(5)	X		(5)	(5)					(5)	
Brushes/Nozzle DOWN	X		X		X	(5)	(5)			IN			
4-Wheel Independent Drive	X	X	X		X		X						
Front & Rear Differential Lock	X			X	X		X			IN			
Hopper Drain OPEN	X		X		X					IN		Hopper Drain Switch: ON	
Fan Brake ENGAGE	X		X							IN		Fan Door: OPEN	(7)
CloudMaker / Water Jets ON	X		X		X					IN		Water Switch in Position 1 (8)	
CloudMaker ON / Water Jets OFF	X		X		X					IN		Water Switch in Position 1 (13)	
CloudMaker OFF / Water Jets ON	X		X		X					IN		Water Switch in Position 2 (8)	
Wander Hose ON	X		X			X		DOWN	ON	IN		Wander Hose Switch: ON (3) (9)	
Brake Lights ON	X	X	X	X	X	(10)	(10)					Transmission pressure less than 20 bar (295 psi) (10)	
Reverse Lights / Backup Alarm ON	X	X	X	X			X						
Pressure Washer ON	X		X			X			ON	IN		Pressure Washer Switch: ON (11)	

Additional Notes:	
(1)	If hopper is raised, machine speed is limited to 25% of normal speed. Accelerator pedal does not control engine speed in Work Mode 1 or 2.
(2)	Accelerator pedal directly controls engine speed when in Transit Mode.
(3)	Also required: Brush Speed Knob must be adjusted to proper level for function to operate. Function will not operate if knob is rotated fully counterclockwise.
(4)	The brush motors will continue to rotate for 6 seconds if machine moves out of Forward Work Mode 1
(5)	Brushes and Nozzle raise in Work Mode 1 if Drive Lever is in Neutral or Reverse.
(6)	Default engine speed is 2200 rpm in Work Mode 1 or 2, & 1200 rpm in Transit Mode.
(7)	When the key is off and the fan brake is engaged, a loud noise will occur.
(8)	Also required: Sufficient supply of water in water tank, In-cab water flow control knob OPEN, Pressure Washer Switch OFF. CloudMaker rotates in Work Mode 1, even with Water Switch OFF.
	Vacuum tube water jet is ON when Water Switch is in position 1 or 2. In-cab water flow control knob controls flow rate to brush jets ONLY.
(9)	Also required: Pressure Washer Switch OFF, Fan Door CLOSED.
(10)	Also required: Release Accelerator Pedal while travelling more than 6.5 km/h (4 mph). Pressing brake pedal activates Brake Lights.
(11)	Also required: Sufficient supply of water in water tank, Wander Hose Switch OFF.
(12)	Also required: Adjust Vacuum Fan Speed Knob for conditions.
(13)	Also required: Sufficient supply of water in water tank, In-cab water flow control knob CLOSED, Pressure Washer Switch OFF. CloudMaker rotates in Work Mode 1, even with Water Switch OFF.

MAINTENANCE

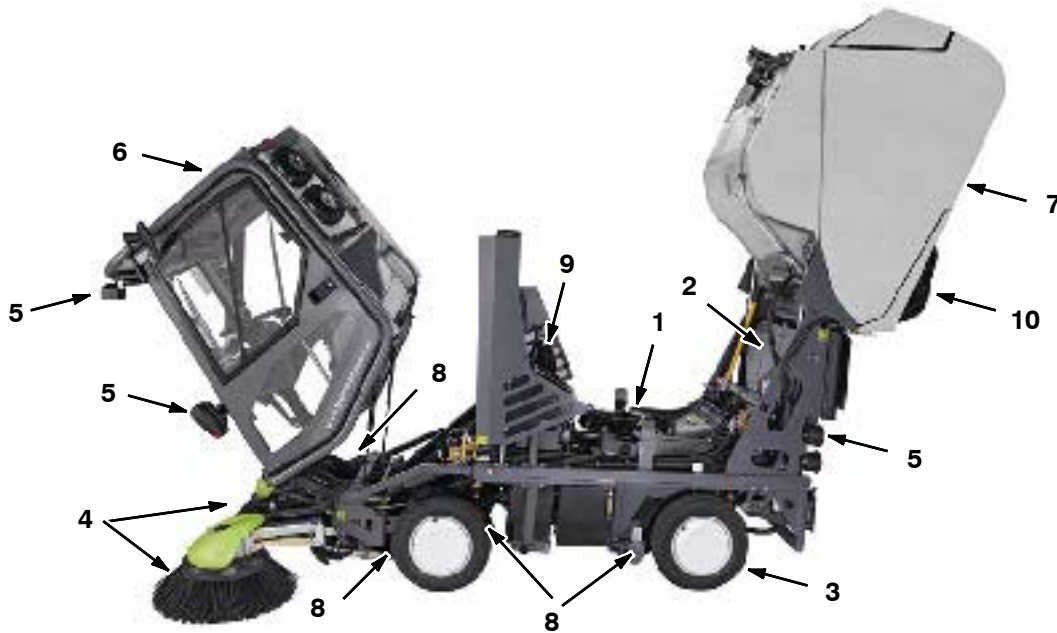

MAINTENANCE CHART

FOR SAFETY: Before leaving or servicing machine, stop on level surface, place drive lever in neutral, set parking brake, and turn off machine.

Interval	Key	Description	Procedure	Lubricant/ Fluid	No. of Service Points
Daily	1	Engine	Check oil level	EO	1
			Check coolant level in reservoir	WG	1
			Check air filter indicator		1
	1	Hydraulic fluid reservoir	Check fluid level	HYDO	1
	1	Windshield washer bottle	Check fluid level	-	1
	2	Water tank	Check water level	-	1
	3	Tires	Check pressure and for damage	-	4
	4	Brushes	Check for wear	-	1
	5	Lights	Check operation and for damage	-	All
		Safety equipment (warning beacon, audible alarms, seat belts, exterior side mirrors, hopper safety arm, cab lock down bracket)	Check operation and for wear and damage	-	All
		Side panels-not shown	Check for damage and ensure they are secured to machine	-	2
	6	Cab	Check operation of controls	-	All
			Check fuel level gauge. Fill tank if necessary	-	1

MAINTENANCE

Interval	Key	Description	Procedure	Lubricant/ Fluid	No. of Service Points
Weekly		Wiring and flexible hoses	Check for damage, wear, and security	-	All
	7	Hopper	Check door, inlet, and fan casing seals for wear and damage	-	All
	2	Water tank	Clean water tank drain cap filter	-	1
50 Hours	1	Fuel lines	Check for wear and damage. Tighten loose clamp bands	-	All
250 Hours	6	Cab	Check windshield wiper for wear and damage	-	1
			Check operation of rear view camera (optional)	-	1
			Lubricate cab pivots	SPL	2
	4	Dust suppression, vacuum, and brushes	Check nozzle flap for wear and damage	-	1
			Check brush arms for wear and damage. Lubricate	SPL	4
			Check brush arm swivels for wear and damage. Lubricate	-	2
			Check cast iron skid for wear and damage. Adjust	-	2
			Check vacuum nozzle skid for wear	-	2
			Check wear plates for wear and damage	-	2
			Check operation of spray jets	-	3
	2	Water tank	Check safety chain for wear and damage	-	1
			Lubricate door hinge	SPL	1
	8	Steering and suspension	Check bell crank levers for wear and damage. Lubricate	SPL	2
			Check front trailing arms for wear and damage. Lubricate	SPL	2
			Check steering arm for wear and damage	-	1
			Check steering linkage for wear and damage	-	1
			Lubricate front hub top bearing	SPL	1
			Lubricate axle beam (upper and lower)	SPL	2
			Check tracking cylinder pivots for wear and damage. Lubricate	SPL	2
			Lubricate rear trailing arms	SPL	2
Check condition of rear axle conical stops				2	

MAINTENANCE

Interval	Key	Description	Procedure	Lubricant/ Fluid	No. of Service Points
250 Hours	7	Hopper	Lubricate hopper lift cylinders	SPL	4
			Lubricate hopper door arms	SPL	2
			Check hopper cyclone screens for wear and damage	-	1
			Check hopper drain seal for wear and damage	-	1
			Check hopper drain screen for wear and damage	-	1
			Check hopper external drain tube for wear and damage	-	1
			Check hopper door screen for wear and damage	-	1
			Clean cyclone drain holes	-	All
			Check vacuum fan access door for damage	-	1
	1	Engine	Change oil and filter	EO	1
			Replace air filter and clean air filter housing and relief valve	-	1
			Check air intake for damage	-	1
			Check radiator screen for wear and damage	-	1
	1	Hydraulics	Check hoses and fittings for leaks, wear, and damage	-	All
			Check hydraulic pressure filter indicator (engine must be running)	-	1
	1	Battery	Check electrolyte level (non-sealed batteries only)	-	1
			Clean and tighten battery cable connections (after initial 250 hours only)	-	1
		Electrical	Check cables and cable connections for wear and damage	-	All
			Check terminals for corrosion	-	All
			Apply terminal stud protectant	-	All
	7	Hopper raised safety switch	Clean and lubricate	ELE	1
	7	Fan access door open safety switch	Clean and lubricate	ELE	1

Interval	Key	Description	Procedure	Lubricant/ Fluid	No. of Service Points
250 Hours	6	Brakes	Check adjustment of parking brake	-	1
			Check parking brake cables for wear and damage. Lubricate	SPL	2
	3	Tires	Check tread depth	-	4
			Torque lug nuts (5 each wheel)	-	20
	5	Cab mountings	Check torque	-	All
	9	Pressure washer (option)	Check manifold filter for wear and damage	-	1
			Check hose and wand for for wear and damage	-	1
750 Hours	4	Dust suppression, vacuum, and brushes	Check nozzle suspension ball joints and chains for wear and damage		1
			Check operation of nozzle hydraulic lift arms and for leaks	-	2
			Check brush lift cylinders pivots and hose connections for wear and damage	-	2
			Check brush float suspension valve for wear and damage	-	1
			Check brush hydraulic cylinders for leaks and linkage for wear and damage		1
			Check operation of CloudMaker		1
	2	Water tank	Check operation of water level sensor	-	1
	8	Steering and suspension	Check steering arms and ball joints for wear and damage	-	All
			Check front axle for wear and damage	-	2
			Check for wear and damage	-	1
			Check stub axle torque	-	1
			Check suspension plate torque	-	1
	1	Engine	Replace fuel filter	-	1
			Replace inline filter (000000-002135)	-	1
			Check fan belt condition and tension	-	1
			Check coolant mixture (50% ethylene glycol)	WG	1
	1	Battery	Clean and grease terminals	ELE	1
	6	Brakes	Check shoes and drums for wear	-	1
	10	Wander hose	Check hose for wear and damage	-	1
			Check adapter seal on hopper for wear and damage	-	1

MAINTENANCE

Interval	Key	Description	Procedure	Lubricant/ Fluid	No. of Service Points
2000 Hours	1	Engine	Drain, flush, and refill radiator (50% ethylene glycol)	WG	1
			Adjust valve clearances	-	4
	1	Hydraulics	Change hydraulic fluid	HYDO	1
			Change auxiliary pressure filter		1
			Change return line filter		1
			Change auxiliary and steering pump hydraulic strainers		1

LUBRICANT/FLUID

EO Turbo Diesel Engine Oil, 15W40 API CF4/ACEA2 only.

HYDO (European built machines) - Turbo Diesel Engine Oil, 15W40 API CF4/ACEA2
(USA built machines) - **TennantTrue** premium hydraulic fluid or equivalent

WG 50/50 mix of water and ethylene glycol permanent, -34° C (-30° F).

SPL Special lubricant, Lubriplate EMB grease (Tennant part number 01433-1)

ELE Dielectric grease

NOTE: More frequent maintenance intervals may be required in extremely dusty conditions.

NOTE: Refer to the Green Machine 636HS Workshop Manual for additional service requirements.

LUBRICATION

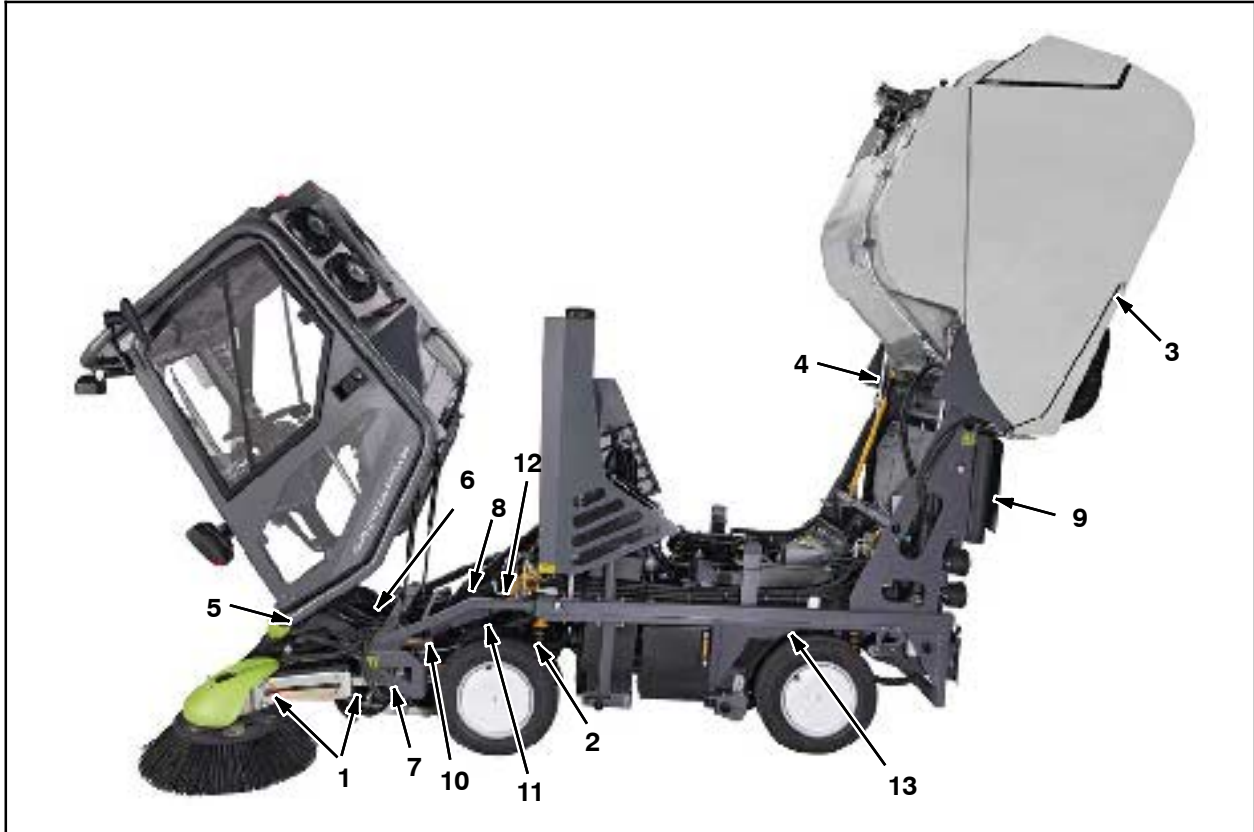

LUBRICATION POINTS

Grease and check the condition of the components listed below at the intervals in the maintenance chart.

- | | |
|--|--|
| <ul style="list-style-type: none"> 1. Brush arms 2. Front trailing arms 3. Right and left hopper door arm 4. Right and left hopper lift cylinders (upper and lower) 5. Cab pivots | <ul style="list-style-type: none"> 6. Brake cables 7. Brush arm swivels 8. Front hub top bearing 9. Water tank door hinge 10. Steering bell crank levers 11. Tracking cylinders 12. Axle beam (upper and lower) 13. Rear trailing arms |
|--|--|

MAINTENANCE

HYDRAULICS

Check the hydraulic fluid level daily. The hopper must be down and the machine at operating temperature before checking the hydraulic fluid level.

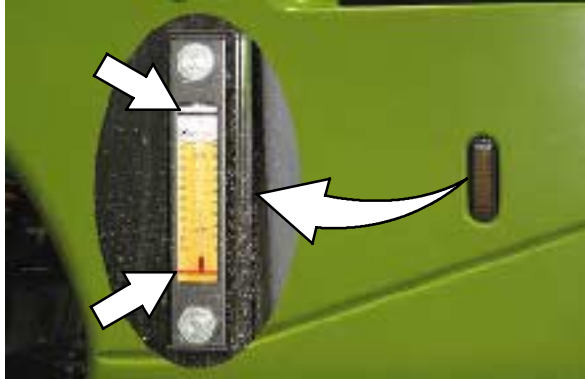

ATTENTION! Do not overfill the hydraulic fluid reservoir or operate the machine with a low level of hydraulic fluid in the reservoir. Damage to the machine hydraulic system may result.

Apply a light film of hydraulic fluid onto the filler cap gasket before reinstalling the cap onto the reservoir.



Check the hydraulic pressure filter indicator after every 250 hours of operation. The machine must be running in order to get an accurate reading from this indicator.

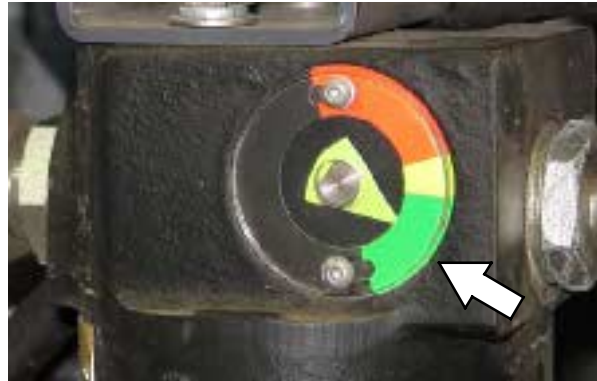

Replace the auxiliary hydraulic pressure filter after every 2000 hours of operation or if the pressure filter indicator arrow is in the yellow/red area of the indicator with the engine running. The filter is useable when the indicator arrow is in the green area of the indicator.



Replace the hydraulic return line filter after every 2000 hours of operation.



Replace the auxiliary and steering pump hydraulic strainers after every 2000 hours of operation.



Drain and refill the hydraulic fluid reservoir with new hydraulic fluid after every 2000 hours of operation.

HYDRAULIC HOSES

Check the hydraulic hoses after every 250 hours of operation for wear, damage, and leaks.

FOR SAFETY: When servicing machine, use cardboard to locate leaking hydraulic fluid under pressure.

High pressure fluid escaping from a very small hole can almost be invisible, and can cause injury.

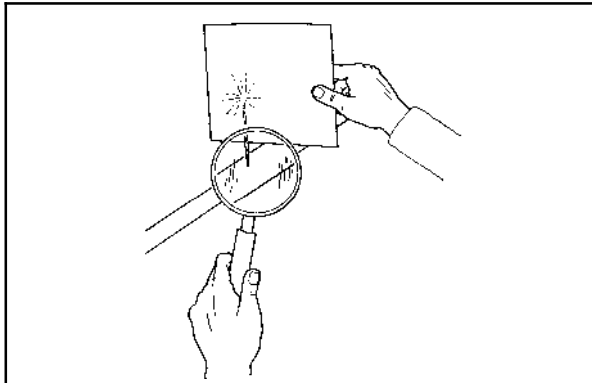

Contact appropriate personnel if a leak is discovered.

ATTENTION: Only use TENNANT supplied hydraulic hoses or equivalent rated hydraulic hoses.

HYDRAULIC FLUID

Machines use two different type of hydraulic fluids depending on where the machine was built. Mixing the fluids is not recommended. Identify the machine build location by the data plate.



European data plate

European built machines use Turbo Diesel Engine Oil, 15W40 API CF4/ACEA2.



USA data plate

USA built machines: There are two fluids available for different temperature ranges:

TennantTrue premium hydraulic fluid (Extended Life)			
Part number	Ambient temperature	ISO Grade	Capacity
1057710	above 7° C (45° F)	100	3.8 L (1 gal)
1057711	above 7° C (45° F)	100	19 L (5 gal)
1057707	below 7° C (45° F)	32	3.8 L (1 gal)
1057708	below 7° C (45° F)	32	19 L (5 gal)

If using a locally-available hydraulic fluid, be sure the specifications match the Tennant hydraulic fluid specifications. Substitute fluids can cause premature failure of hydraulic components.

ATTENTION! Hydraulic components depend on system hydraulic fluid for internal lubrication. Malfunctions, accelerated wear, and damage will result if dirt or other contaminants enter the hydraulic system.

MAINTENANCE

ENGINE

ENGINE OIL

Check the engine oil level daily. Change the oil and filter after every 250 hours of operation.



Fill the engine with oil until the oil is between the indicator marks on the dipstick. DO NOT fill past the top indicator mark. The engine oil capacity is 6 L (6.35 qt) with oil filter.

COOLING SYSTEM

FOR SAFETY: When servicing machine, avoid contact with hot engine coolant.

Check the coolant level in the reservoir daily. The coolant level must be between the two indicator marks when the engine is cold.



FOR SAFETY: When servicing machine, do not remove cap from radiator when engine is hot. Allow engine to cool.

Check the condition of the radiator and radiator screen after every 250 hours of operation.



Check the coolant mixture every 750 hours of operation.

Flush the radiator and the cooling system after every 2000 hours of operation.

ENGINE BELT

Check the belt tension after every 750 hours of operation. Adjust tension as necessary. Proper belt tension is 7 mm to 9 mm (0.28 to 0.35 in).

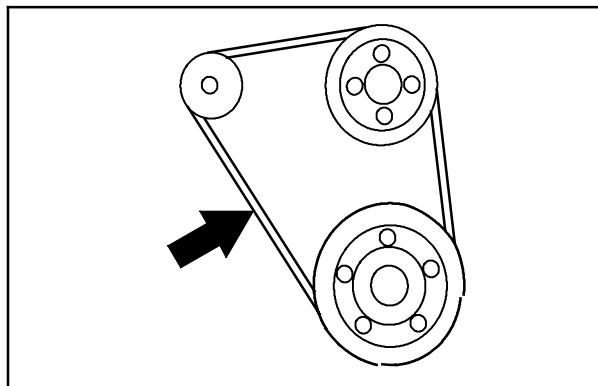

WARNING: Moving belt and fan. Keep away.

AIR FILTER

Check the air filter indicator daily.



Check the air filter housing relief valve for wear and damage after every 250 hours of operation. Clean dust and debris from the relief valve.



Replace the air filter after every 250 hours or when the red "CHANGE FILTER WHEN RED" stripe appears on the indicator.



Check condition of and clean the air intake after every 250 hours of operation.



Clean the interior of the air filter housing after every 250 hours of operation.



Press the reset button to reset the air filter indicator after replacing the air filter.



MAINTENANCE

FUEL FILTERS

Replace the fuel filter after every 750 hours of operation. To avoid extensive bleeding of the fuel system when replacing the fuel filter, fill the new filter with as much diesel fuel as possible before installing the filter.

FOR SAFETY: When servicing machine, keep flames and sparks away from fuel system service area. Keep area well ventilated.



On machines below serial number 002135, replace the inline fuel filter after every 750 hours of operation.



FUEL LINES

Check the fuel lines every 50 hours of operation. If the clamp band is loose, apply oil to the screw of the band and securely tighten the band.

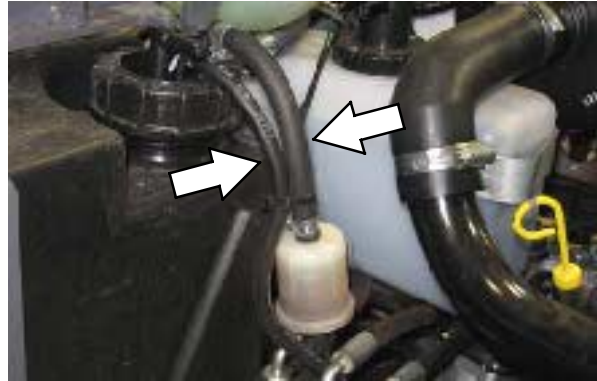

The rubber fuel lines can become worn-out whether the engine has been used much or not. Replace the fuel lines and clamp bands every two years.

FOR SAFETY: When servicing machine, keep flames and sparks away from fuel system service area. Keep area well ventilated.

If the fuel lines and clamp bands are worn or damaged before two years time; replace or repair them at once. Bleed the fuel system after replacement of any fuel lines, see PRIMING THE FUEL SYSTEM. When the fuel lines are not installed, plug both ends with clean cloth or paper to prevent dirt from entering the lines. Dirt in the lines can cause fuel injection pump malfunction.

PRIMING THE FUEL SYSTEM

Typical diesel fuel systems require priming to remove pockets of air from the fuel lines and fuel components. This is usually required after running out of fuel, changing fuel filter elements or repairing a fuel system component. Air in the fuel prevents smooth engine operation.

This fuel system however is self-priming. The return line comes from the top of the injector that allows the air to escape through the return line.

VALVE CLEARANCES

Check and adjust the valve clearances after every 2000 hours of operation.

BATTERY

Check the electrolyte level in non-sealed batteries after every 250 hours of operation. Never add acid to the batteries. Add distilled water *only*. Always keep the battery caps on, except when adding water or taking hydrometer readings.

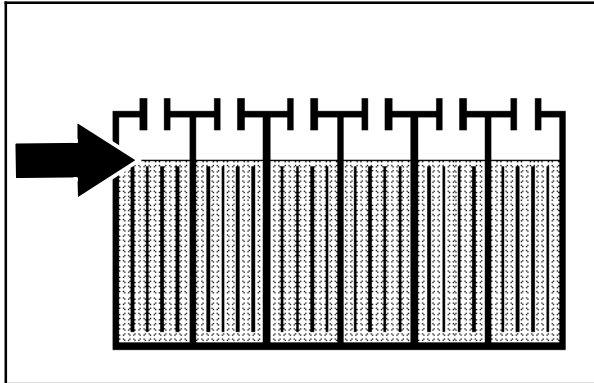

Using a hydrometer, measure the specific gravity to determine the charge level and condition of the batteries. If one or more of the battery cells test lower than the other battery cells, the cell is damaged, shorted, or is near failure. Replace the battery if it is damaged.

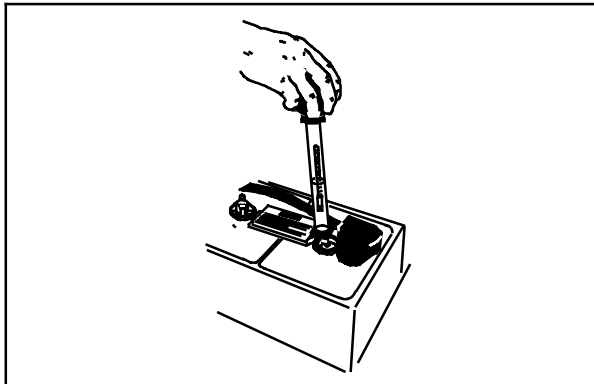

Clean the battery terminals after every 750 hours of operation. Apply a light coat of dielectric grease onto the terminals after they have been cleaned.



FOR SAFETY: When servicing machine, avoid contact with battery acid.

If the machine is equipped with a maintenance free battery, clean and tighten the battery connections after the first 250 hours of operation and after every 750 hours after that. Do not remove the vent plugs from the battery or add water to the battery.

FUSES

REPLACING THE FUSES

Remove the fuse box cover to access fuses.



Refer to the diagram inside the fuse box cover for locations of the *fuses* in the fuse box and the circuits protected. Always replace a fuse with a fuse of the same type and amperage rating.



Refer to the tables below for the *fuses* and circuits protected.

Fuse Box 1	
Rating	Circuit Protected
4 A	Left Side Position Lights
4 A	Right Side Position Lights
15 A	Main Beam
10 A	Right Side Dipped Beam
10 A	Left Side Dipped Beam
4 A	Fog Lights
10 A	Work Lights
4 A	Main Lights Switch Feed

Fuse Box 2	
Rating	Circuit Protected
4 A	IQAN - MDM RTC
4 A	IQAN - MDM
10 A	IQAN - XS - A0
20 A	IQAN - XT2 - A0
20 A	IQAN - XT2 - A1T
30 A	Heated Screen Element
4 A	Heat Screen Timer & Switch
10 A	Water Pump Relay

Fuse Box 3	
Rating	Circuit Protected
4 A	Alternator, No Charge, Oil Pressure Warning, Fuel Pump
20 A	Heater, AC Evaporator
10 A	Tachometer, Water Temperature Gauge, Fuel Gauge, Brake Lights
10 A	Warning Beacon, Voice Box, Indicators
10 A	Reverse Camera, Monitor, Radio
15 A	Wipers, Modem, Screen Wash, Horn
10 A	AC Compressor
10 A	Engine Stop Solenoid

NOTE: Always replace a fuse with a fuse of the same type and amperage rating.

BRUSHES

Check the brushes for wear daily. Remove tangled debris from the brushes and brush drive motors.

FOR SAFETY: Before leaving or servicing machine, stop on level surface, place drive lever in neutral, set parking brake, turn off machine, and remove key from ignition.

REPLACING THE BRUSHES

Replace the brushes when the bristles are approximately 76 mm (3 in) in length or when the brushes no longer adequately sweep.

1. Remove the brush assembly cover.
2. Loosen the six allen screws with the provided tool.



3. Remove the brush from the brush drive.



4. Install the new brush. Rotate the right brush clockwise and the left brush counterclockwise until all the allen screws slide into the slots. Tighten the screws.

5. Reinstall the brush assembly cover.
6. Adjust the brush angle. See *ADJUSTING THE BRUSH ANGLE* section of this manual.

ADJUSTING THE BRUSH ANGLE

Adjust the angle for each brush so debris is swept toward the center of the machine. For best sweeping performance the left brush bristles should touch the surface between 2 o'clock and 8 o'clock and the right brush bristles should touch the surface between 10 o'clock and 4 o'clock when sweeping.



1. Remove the brush assembly cover.



MAINTENANCE

2. Adjust the roll (side to side) angle. Loosen the two nuts. Adjust the angle of the brush assembly. Tighten the hex nuts.

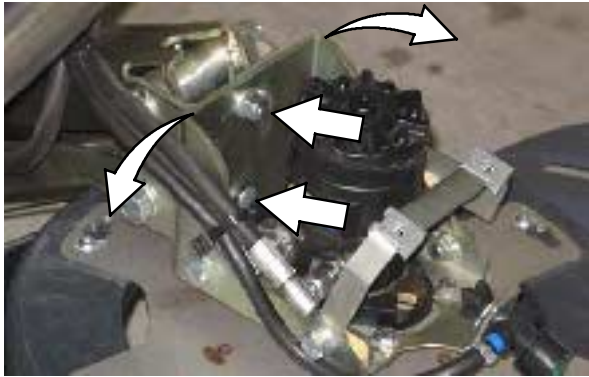

3. Adjust the pitch (front to rear) angle. Loosen the four hex screws. Adjust the angle of the brush assembly. Tighten the hex screws.



4. Reinstall the brush assembly cover.

BRUSH LINKAGE

Check the brush hydraulic cylinders for leaks and the linkage for wear and damage every 750 hours of operation.



DUST SUPPRESSION / VACUUM

FOR SAFETY: Before leaving or servicing machine, stop on level surface, place drive lever in neutral, set parking brake, turn off machine, and remove key from ignition.

ADJUSTING / REPLACING THE NOZZLE FLAP

Check the nozzle flap and adjustment knob for wear and damage every 250 hours of operation. Replace the nozzle flap when it is approximately 12 cm (5 in) in length.

1. Start the machine, place the machine into Work Mode 1, and set the vacuum fan speed to 2200 rpm.



2. Operate the machine and listen for the nozzle flap vibration. It should be possible to hear the flap vibration inside the cab, but the noise should not be so excessive that it disturbs persons in areas near the machine.

NOTE: Little or no flap vibration is necessary for light sweeping (light litter). More flap vibration may be necessary for heavier sweeping (wet sand).

3. Turn the adjustment knob clockwise to increase the flap height and vibration and counterclockwise to decrease the flap height and vibration.



4. Lock the adjustment knob when through making adjustments.



5. Operate the machine and listen for flap vibration. Repeat procedure if additional adjustments are necessary.

MAINTENANCE

VACUUM NOZZLE SKID

Check the vacuum nozzle skid for wear every 250 hours of operation. Replace the vacuum nozzle skid when its thickness is 15 mm (0.60 in) or less.



CAST IRON SKID

Use the hex nut screws to adjust the wear plates so the bottom edges are 19 mm (0.75 in) from the ground. Ensure the cast iron skid is level with the vacuum nozzle skid.

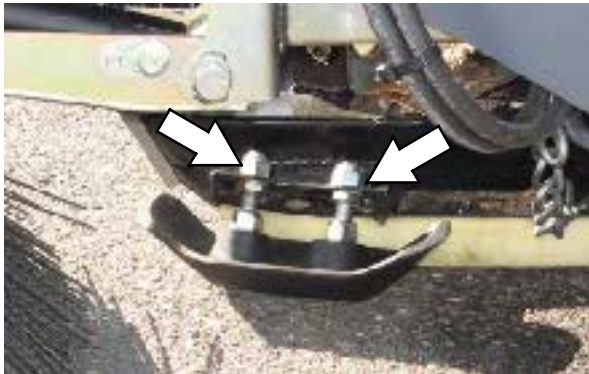

Check the cast iron skid for wear and damage every 250 hours of operation.

SPRAY JETS

Clean the spray jet filters every 250 hours of operation. A spray jet is located above each brush and inside the vacuum tube. Loosen the thumb screw to remove the spray jet from the vacuum tube.

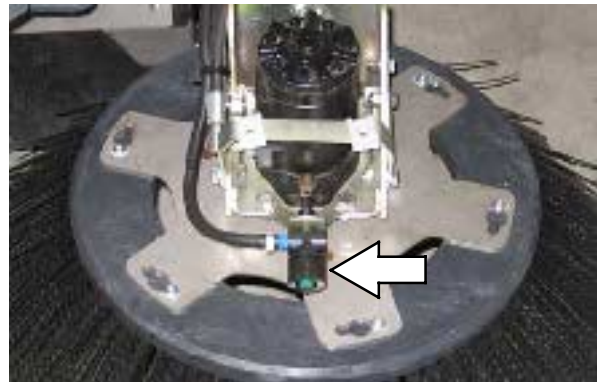

CLOUDMAKER

Check the CloudMaker for damage and to ensure it is functioning every 750 hours of operation.

**WATER TANK DOOR RETAINER CHAIN**

Check the water tank door retainer chain for damage every 250 hours of operation. Replace the chain if it is damaged.

**WATER TANK****DRAIN CAP FILTER**

Check the drain cap filter for damage and clean the filter weekly.

**WATER LEVEL SENSOR**

Check the water tank water level sensor for damage every 750 hours of operation. Replace the level sensor if it is damaged or if the wires are worn or damaged.



HOPPER

HOPPER DOOR, HOPPER INLET, AND VACUUM FAN ACCESS DOOR SEALS

Check the hopper door, hopper inlet, and vacuum fan access door seals weekly for wear or damage.

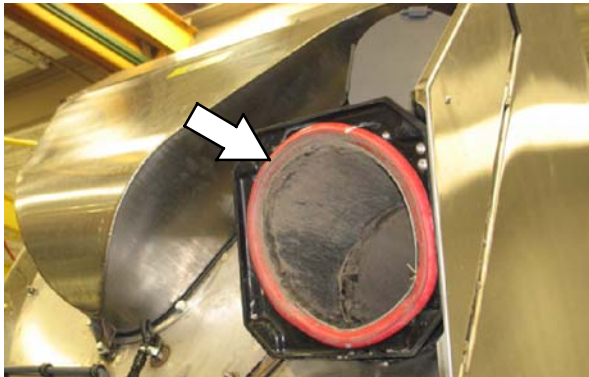
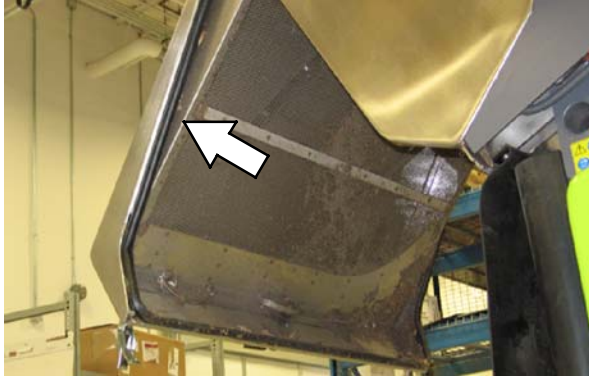

HOPPER DRAIN SEAL

Check the hopper drain seal for wear and damage every 250 hours of operation.

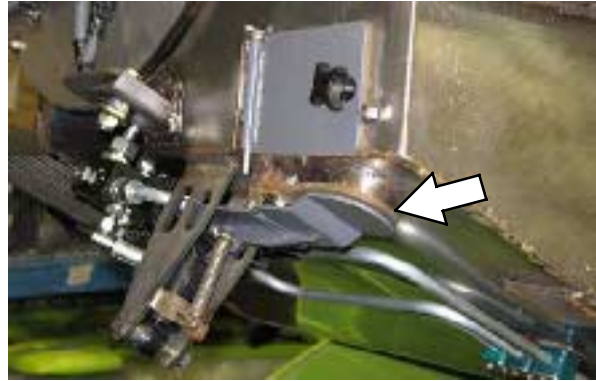

HOPPER CYCLONES SCREENS

Check the hopper cyclone screens for wear and damage every 250 hours of operation. Be sure the cyclone drain holes are clear.

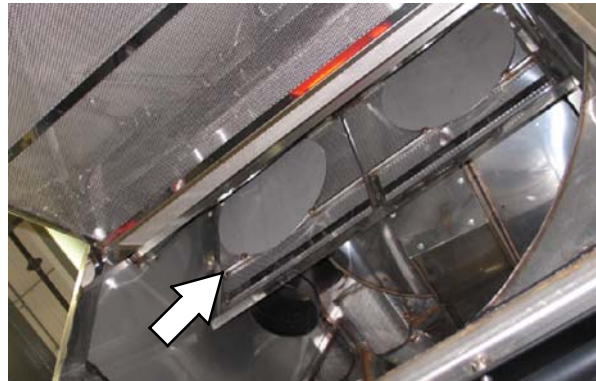

HOPPER DRAIN SCREEN

Check the hopper drain screen for wear and damage every 250 hours of operation.

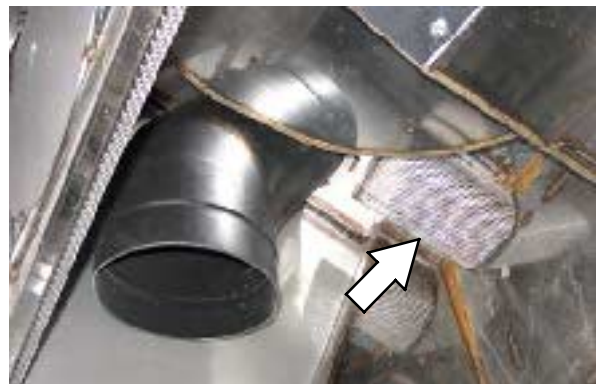

HOPPER EXTERNAL DRAIN TUBE

Check the hopper external drain tube for wear and damage every 250 hours of operation.

**HOPPER RAISED SAFETY SWITCH**

Clean the hopper raised safety switch every 250 hours of operation. Apply a light coat of dielectric grease onto the switch after it is cleaned.

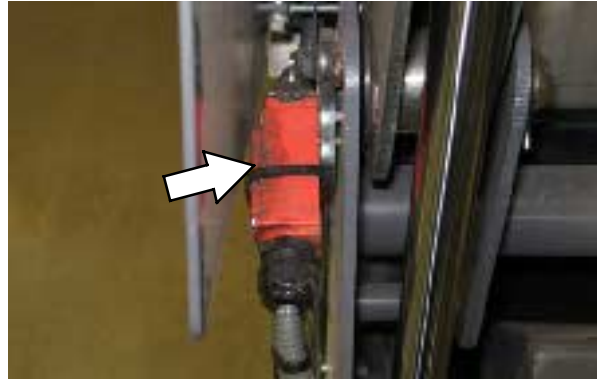
**HOPPER DOOR SCREEN**

Check the hopper door screen for wear and damage every 250 hours of operation.

**VACUUM FAN DOOR SAFETY SWITCH**

Clean the vacuum fan door safety switch every 250 hours of operation. Apply a light coat of dielectric grease onto the switch after it is cleaned.

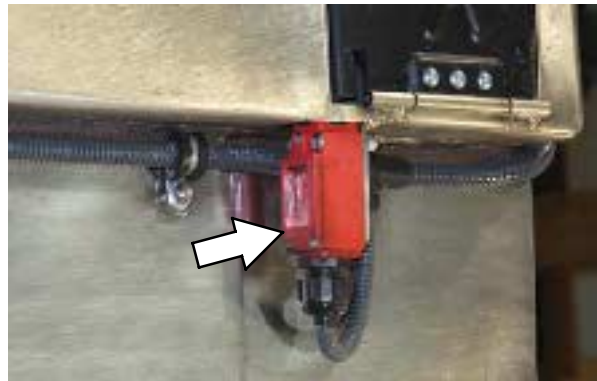
**VACUUM FAN ACCESS DOOR**

Check the vacuum fan access door for wear and damage every 250 hours of operation.



MAINTENANCE

CAB

Check all lights, gauges, controls, and safety equipment for proper operation daily.

WINDSHIELD WIPER BLADES

Check the windshield wiper blade for wear and damage every 250 hours of operation. Replace when necessary.

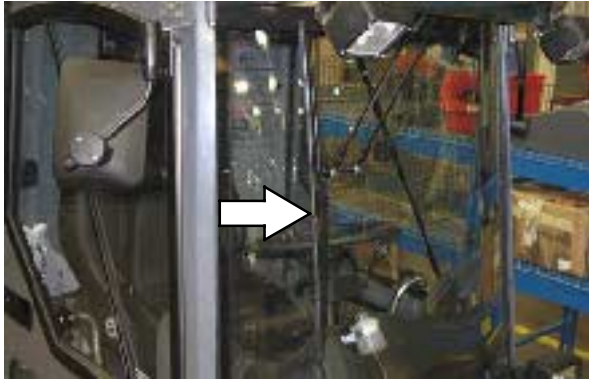

REAR VIEW CAMERA (OPTION)

Check the rear view camera every 250 hours of operation. Clean the camera lens with a soft clean cloth.



WINDSHIELD WASHER FLUID

Check the windshield washer fluid level daily. Fill with automotive windshield washer fluid.



STEERING AND SUSPENSION

Check the suspension components every 750 hours of operation. Check the bushings, springs, conical stops, and pins for wear and damage. Check the suspension springs for leaks. Replace worn or damaged components.



Check the front axle components for wear and damage every 750 hours of operation. Replace all worn or damaged components.

Check the steering linkage components for wear and damage every 250 hours of operation. Replace worn or damaged components.

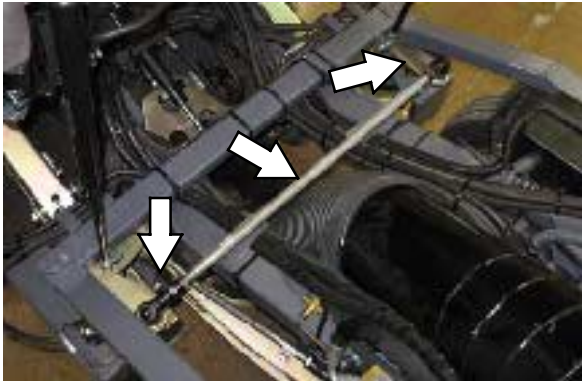

Check the steering ball joints every 750 hours of operation. Replace damaged or worn ball joints.

BRAKES AND TIRES

SERVICE BRAKES

Check the service brakes after every 250 hours of operation.



Check the service brake shoes and drums for wear after every 750 hours of operation.

Check the brake fluid level at the brake fluid reservoir after every 250 hours of operation.



PARKING BRAKES

Check the parking brake adjustment after every 250 hours of operation.

TIRES

Check the tires for damage and the tire pressure daily. The proper air pressure is 648 ± 35 kPa (94 ± 5 psi). Check the tread depth, 2 mm (0.08 in), minimum after every 250 hours of operation.



WHEEL TORQUE

Torque wheel nuts twice in the pattern shown to 145 to 150 Nm (107 to 110 ft lb) after every 250 hours of operation.

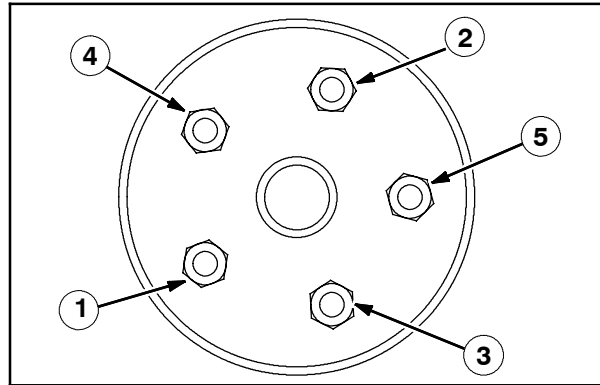

WANDER HOSE

Check the wander hose and the adapter seal on the hopper for wear and damage every 750 hours of operation.

**PRESSURE WASHER (OPTION)**

Check the pressure washer wand and system hoses for wear and damage every 250 hours of operation.



Check the pressure washer manifold filter for wear and damage every 250 hours of operation.



TILTING / LOWERING THE CAB

TILTING THE CAB

FOR SAFETY: Before leaving or servicing machine, stop on level surface, place drive lever in neutral, set parking brake, turn off machine, and remove key from ignition.

1. Remove loose items from inside the cab.
2. Remove the lock down bracket located on the right rear of the cab from the frame of the machine.

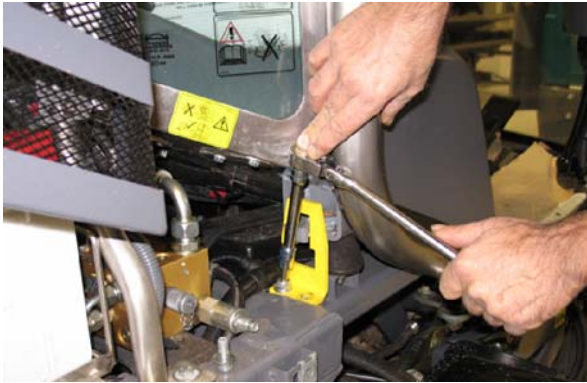

3. Lift the safety hook handle located on the left rear side of the cab and tilt the cab.



LOWERING THE CAB

1. Lower the cab to the frame of the machine.
2. Be sure the safety hook is secure in the bracket.



3. Place the lock down bracket onto the lock down hook and reinstall the lock down bracket onto the frame of the machine.



TILTING / LOWERING THE HOPPER MANUALLY

FOR SAFETY: Before leaving or servicing machine, stop on level surface, place drive lever in neutral, set parking brake, turn off machine, and remove key from ignition.

TILTING THE HOPPER MANUALLY

Use the hopper pump to manually tilt the hopper if machine is disabled.

1. Remove right side panel from the machine.
2. Remove the pump handle from the storage area inside the left access door.
3. Insert the pump handle into the hopper pump.
4. Confirm the hopper pump needle valve knob is turned fully clockwise to ensure the needle valve is closed.

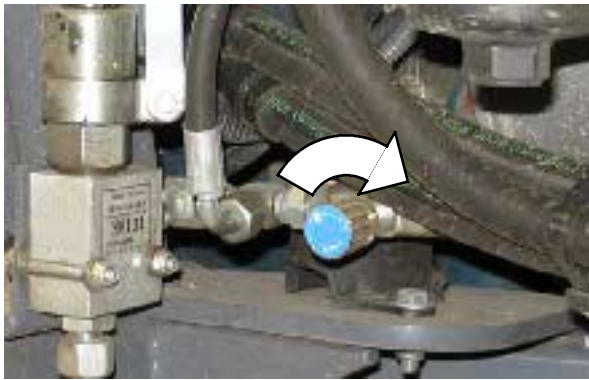

FOR SAFETY: When using machine, make sure adequate clearance is available before raising hopper.

5. Use the hopper pump to manually tilt the hopper.

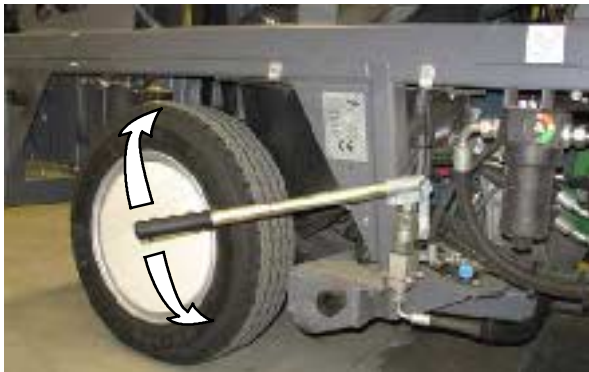

6. Engage the hopper safety arm.



! WARNING: Raised hopper may fall. Engage hopper safety arm.

7. Remove the pump handle from the hopper pump and return the pump handle to the storage location inside the left access door.

If the engine is operable, see *RAISING / LOWERING THE HOPPER* section of this manual. If the engine is inoperable, see *LOWERING THE HOPPER MANUALLY* section of this manual.

MAINTENANCE

LOWERING THE HOPPER MANUALLY

1. Disengage the hopper safety arm.



2. Slowly turn the hopper pump needle valve knob fully counterclockwise and allow the hopper to completely lower down to the frame of the machine.

NOTE: Several personnel may be necessary to push the hopper over the center point so the weight of the hopper lowers the hopper.



WARNING: Lift arm pinch point. Stay clear of hopper lift arms.

NOTE: Keep personnel clear of the area around the hopper before manually lowering the hopper.



3. Turn the hopper pump needle valve knob fully clockwise to close the needle valve.

NOTE: The power hopper tilt system will not operate if the hopper pump needle valve knob is left open.

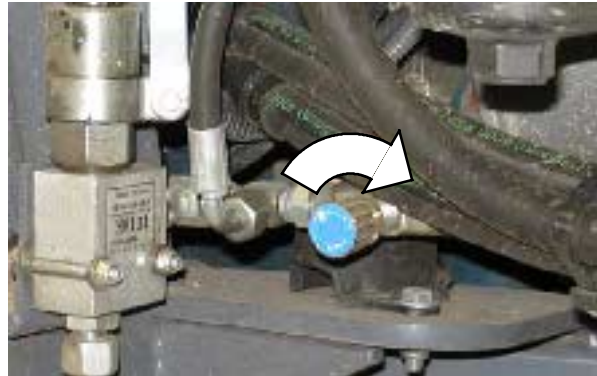

TOWING / TRANSPORTING THE MACHINE

TOWING THE MACHINE

If the machine becomes disabled, it can be only towed from the tow point located at the front of the machine.

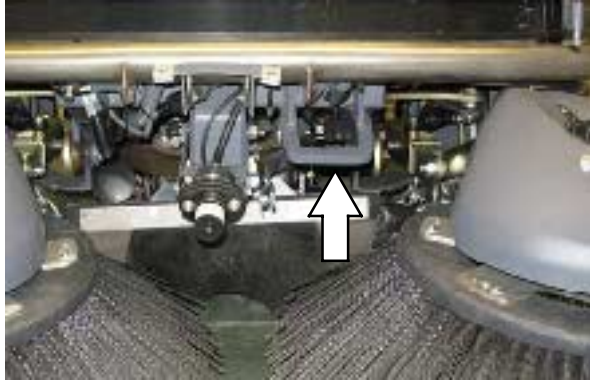

Use the *emergency tow valve* located on the transmission pump to prevent damaging the hydraulic system when towing the machine. This valve allows a disabled machine to be moved for a *very short distance* and at a speed to not exceed 1.6 kp/h (1 mph). The machine is NOT intended to be towed a long distance or at a high speed.

ATTENTION! Do not tow machine for a long distance or damage may occur to the propelling system.

Turn the *emergency tow valve* 90° (either direction) before towing the machine. Return the bypass valve to the normal position when finished towing the machine. **Do Not** open the emergency tow valve during normal machine operation.



TRANSPORTING THE MACHINE

1. Raise the brushes.

NOTE: Empty the hopper and water tank before transporting.

2. Position the front of the machine at the loading edge of the truck or trailer.

FOR SAFETY: When loading machine onto truck or trailer, use winch. Do not drive the machine onto the truck or trailer unless the loading surface is horizontal AND is 380 mm (15 in) or less from the ground.

3. If the loading surface is horizontal and 380 mm (15 in) or less from the ground, drive the machine up onto the truck or trailer.

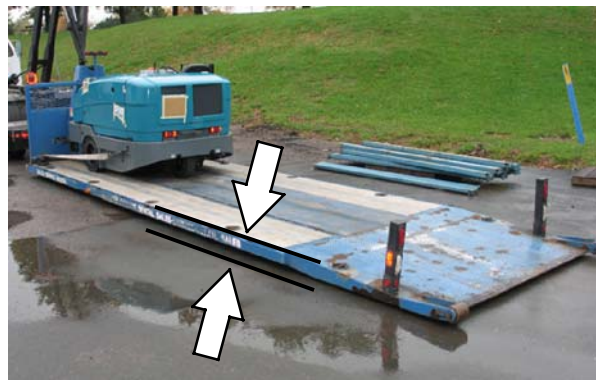

MAINTENANCE

4. To winch the machine onto the truck or trailer, attach the winching chains to the tow point or tie-down bar.

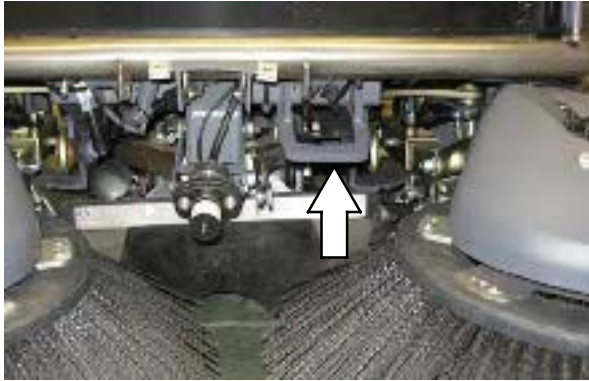

5. Position the machine as close to the front of the trailer or truck as possible.
6. Set the parking brake and place a block behind each wheel to prevent the machine from rolling.
7. Start the machine, place the machine into Work Mode 1, and lower the brushes. Turn off the machine.

8. Connect the tie-down straps to the tie down points.

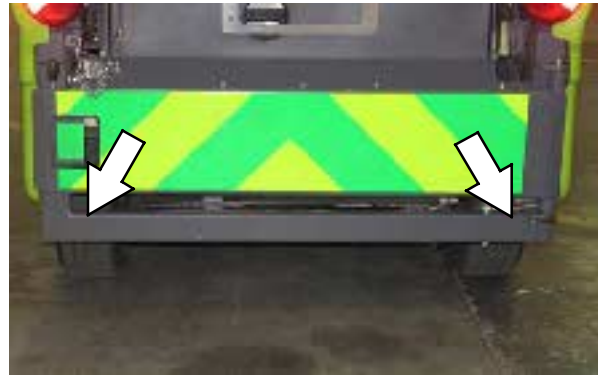

9. Route the tie-down straps to the opposite ends of the machine and hook them to the brackets on the floor of the trailer or truck. Tighten the tie-down straps.

NOTE: It may be necessary to install tie-down brackets to the floor of the trailer or truck.

FOR SAFETY: When unloading machine off truck or trailer, use winch. Do not drive the machine off the truck or trailer unless the loading surface is horizontal AND 380 mm (15 in) or less from the ground.

10. If the loading surface is horizontal AND is 380 mm (15 in) or less from the ground, drive the machine off the truck or trailer.

MACHINE JACKING

Empty the hopper and water tank before jacking up the machine. Jack up the machine at the designated locations. Use a hoist or jack capable of supporting the weight of the machine. Use appropriately rated jack stands to support the machine.

FOR SAFETY: Before leaving or servicing machine, stop on level surface, place drive lever in neutral, set parking brake, turn off machine, and remove key from ignition.

FOR SAFETY: When servicing machine, block machine tires before jacking machine up. Use a hoist or jack that will support the weight of the machine. Jack machine up at designated locations only. Support machine with jack stands.

Rear jacking locations are located directly beneath the rear bumper and in front of each rear tire.

Front jacking locations are located on the frame directly in front of the front tires.



STORAGE AND FREEZE PROTECTION

Before storing the machine for an extended period, the machine must be prepped to lessen the chances of being damaged. It is recommend that a full service be carried out before storing the machine. Contact an authorized service representative.

STORING THE MACHINE

The following steps should be taken prior to storing the machine for extended periods.

FOR SAFETY: Before leaving or servicing machine, stop on level surface, place drive lever in neutral, set parking brake, turn off machine, and remove key from ignition.

1. Empty and clean the hopper.
2. Remove the drain cap and completely drain both water tanks. Reinstall the drain cap when the water tanks are empty.



3. Park the machine in a cool, dry area. Do not expose the machine to rain. Store indoors.

FREEZE PROTECTION

FOR SAFETY: Before leaving or servicing machine, stop on level surface, place drive lever in neutral, set parking brake, and turn off machine.

1. Empty and clean the hopper.
2. Remove the drain cap and completely drain both water tanks. Reinstall the drain cap when the water tanks are empty.



3. Pour 3.8 liters (1 gallon) of full strength Propylene Glycol Based / Recreational Vehicle (RV) antifreeze into the water tank. Do not dilute.
4. Start the machine and operate the dust control system until RV antifreeze is discharging from the CloudMaker, both brush spray jets, and the vacuum tube spray jet.

SPECIFICATIONS

GENERAL MACHINE DIMENSIONS/CAPACITIES

Item	Dimension/capacity
Length (standard machine)	3450 mm (136 in)
Height (warning beacon folded down)	1980 mm (78 in)
Width/frame	1140 mm (45 in)
Width (Transit Mode-wheels extended)	1370 mm (54 in)
Width (Work Mode 1 / Work Mode 2-wheels in)	950 mm (37.4 in)
Ground clearance	130 mm (5.25 in)
Cleaning path width (maximum-brushes fully extended)	2050 mm (80.7 in)
Cleaning path width (minimum-brushes completely in)	1200 mm (47 in)
Wheel base	1400 mm (55 in)
Brush diameter	750 mm (29.5 in)
Water tank capacity	190 L (49 gal)
Debris hopper volume capacity	1 m ³ (1.33 yd ³)
Debris hopper weight capacity	800 kg (1760 lbs)
Dump height (variable to)	1460mm (57.5 in)
Minimum ceiling dump height	1460mm (57.5 in)
Weight - empty	1950 Kg (4300 lbs)
GVWR	2800 Kg (6160 lbs)
Operating Sound Level At Operator Ear	80 ±1.5 dBA
Vibration level at steering wheel does not exceed	2.5 m/s ²
Vibration level at operator station does not exceed	0.5 m/s ²

GENERAL MACHINE PERFORMANCE

Item	Measure
Turning dimension (curb to curb)	3250 mm (128 in)
Turning dimension (wall to wall)	4100 mm (161.5 in)
Travel speed forward (maximum-transit mode) - maximum determined by local regulations	40 Km/h (25 mph)
Travel speed forward (maximum-work mode 1)	13 Km/h (8 mph)
Travel speed forward (maximum-work mode 2)	16 Km/h (9 mph)
Travel speed reverse (maximum)	6 Km/h (4 mph)
Vacuum Speed-standard	0-2400 rpm
Vacuum Speed-boosted (maximum)	2700 rpm
Maximum rated climb and descent	9°/20%

SPECIFICATIONS

HYDRAULIC SYSTEM

System	Capacity	Fluid Type
Hydraulic reservoir	35 L (9.2 gal)	European built Machines: Turbo Diesel Engine Oil, 15W40 API CF4/ACEA2 (or higher)
Hydraulic total	55 L (15 gal)	USA built Machines: TennantTrue premium hydraulic fluid or equivalent

STEERING

Type	Power source
Front wheels, hydraulic cylinder	Hydraulic pump

POWER TYPE

Engine	Type	Compression	Cycle	Aspiration	Cylinders	Bore	Stroke
Kubota V1505TE	Piston	Diesel	4	Turbo	4	78 mm (3.07 in)	78.4 mm (3.08 in)
	Displacement		Net power, governed		Net power, maximum		
	1498 cc (91.4 cu in)		31.3 kw (42 hp) @ 2400 rpm (adjustable to 2800)		27.2 kw (44.2 hp) @ 3000 rpm		
	Fuel		Cooling system		Electrical system		
	Diesel, 45 cetane minimum, low sulfur Fuel tank: 55 L (14.5 gal)		50/50 water/ethylene glycol antifreeze		12 V nominal		
			Total: 13.5 L (3.6 gal)		60 A alternator 90 A alternator when equipped with AC		
			Radiator: 6 L (1.6 gal)				
	Idle speed, no load		Valve clearance, cold		Engine lubricating oil with filter		
1100 ± 25 rpm				6 L (6.35 qt) 15W40 API CF4/ACEA2			

BRAKING SYSTEM

Type	Operation
Service brakes	Expanding shoe drums (front and back)
Parking brake	

TIRES

Location	Type	Size
Front / Rear (4)	Pneumatic	155/70 R12C - Rating 104 / 102

MACHINE DIMENSIONS

