

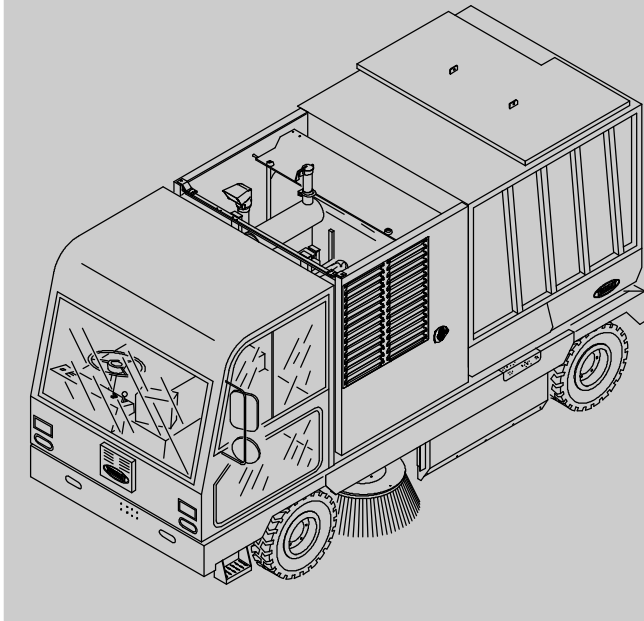

SENTINEL®

Sweeper Operator Manual



TennantTrue™ Parts and Supplies

North America / International

www.tennantco.com

331000
Rev. 07 (5-2010)





This manual is furnished with each new model. It provides necessary operation and maintenance instructions.

Read this manual completely and understand the machine before operating or servicing it.

This machine will provide excellent service. However, the best results will be obtained at minimum costs if:

- The machine is operated with reasonable care.
- The machine is maintained regularly - per the machine maintenance instructions provided.
- The machine is maintained with manufacturer supplied or equivalent parts.

	PROTECT THE ENVIRONMENT
	Please dispose of packaging materials, old machine components such as batteries, hazardous fluids including antifreeze and oil, in an environmentally safe way according to local waste disposal regulations.
	Always remember to recycle.

MACHINE DATA	
Please fill out at time of installation for future reference.	
Model No. -	_____
Serial No. -	_____
Machine Options -	_____
Sales Rep. -	_____
Sales Rep. phone no. -	_____
Customer Number -	_____
Installation Date -	_____

Tennant Company

PO Box 1452

Minneapolis, MN 55440

Phone: (800) 553-8033 or (763) 513-2850

www.tennantco.com



CALIFORNIA PROPOSITION 65 WARNING:

Engine exhaust from this product contains chemicals known to the State of California to cause cancer, birth defects, or other reproductive harm.

Thermo-Sentry, Total View and Vario Sweeping Brush are US registered trademarks of Tennant Company.

Specifications and parts are subject to change without notice.

Original instructions, Copyright © 2003, 2005-2010 TENNANT, Printed in U.S.A.

CONTENTS

	Page		Page
SAFETY PRECAUTIONS	4	AIR CIRCULATION VENTS	28
OPERATION	8	LOW BRAKE PRESSURE LIGHT ...	29
OPERATOR RESPONSIBILITY	8	INCLINE LIGHT (High Dump Model) .	29
MACHINE COMPONENTS	9	ENGINE SHUTDOWN	
CONTROL PANEL SYMBOLS	10	OVERRIDE SWITCH	30
CONTROLS AND INSTRUMENTS	12	PARKING BRAKE SWITCH	30
OPERATION OF CONTROLS	17	LEFT SIDE BRUSH WATER VALVE	
OPERATOR SEAT	17	KNOB (OPTION)	31
SEAT BELTS	17	VARIO SWEEPING BRUSH LEFT	
STEERING WHEEL	18	WATER VALVE KNOB (OPTION) .	31
STEERING WHEEL TILT LEVER		VARIO SWEEPING BRUSH RIGHT	
(For machines serial number		WATER VALVE KNOB (OPTION) .	32
007053 and below)	18	RIGHT SIDE BRUSH WATER	
STEERING WHEEL TILT LEVER		VALVE KNOB (OPTION)	32
(For machines serial number		FUSES	33
007054 and above)	18	ENGINE WATER TEMPERATURE	
PARKING LIGHTS, HEADLIGHTS,		GAUGE	34
BRIGHT HEADLIGHTS, SIGNAL,		FUEL LEVEL GAUGE	34
AND HORN SWITCH	19	ENGINE OIL PRESSURE GAUGE ..	34
WINDSHIELD WIPER AND		VOLTMETER	35
WASHER SWITCH	19	HOURMETER	35
IGNITION SWITCH (For machines		ODOMETER	35
serial number 007709 and below) .	20	SPEEDOMETER	35
IGNITION SWITCH (For machines		TACHOMETER	36
serial number 007710 and above) .	20	SWITCH PANEL	37
PROPELLING PEDAL	20	HOPPER TILT BACK SWITCH	37
BRAKE PEDAL	21	HOPPER TILT FORWARD SWITCH .	37
ACCESSORY POWER SOCKET	21	HOPPER LIFT SWITCH	
DIRECTIONAL LEVER	21	(High Dump Model)	38
THROTTLE LEVER	22	HOPPER LOWER SWITCH	
VARIO SWEEPING BRUSH LOCK PIN		(High Dump Model)	38
(OPTION)	22	HOPPER DOOR OPEN SWITCH	39
VARIO SWEEPING BRUSH		HOPPER DOOR CLOSE SWITCH ..	39
TILT/ARM SWITCH (OPTION) ...	22	WATER PUMP SWITCH (OPTION) ..	39
VARIO SWEEPING BRUSH		LEFT SIDE BRUSH SWITCH	
JOYSTICK (OPTION)	23	(OPTION)	40
VARIO SWEEPING BRUSH		RIGHT SIDE BRUSH SWITCH	40
ON-OFF SWITCH (OPTION)	24	FILTER SHAKER SWITCH	40
VARIO SWEEPING BRUSH		CONVEYOR REVERSE SWITCH ...	41
RAISE-LOWER SWITCH		VACUUM FAN SWITCH	41
(OPTION)	24	SWEEP SWITCH	42
BRIGHT HEADLIGHTS LIGHT	25	4-WAY WARNING LIGHTS SWITCH .	43
PARKING BRAKE LIGHT	25	HAZARD LIGHT SWITCH	43
SIGNAL LIGHT	25	SIDE BRUSH SPOT LIGHT(S)	
GLOW PLUG LIGHT	26	SWITCH	43
CLOGGED ENGINE AIR FILTER		REAR NIGHT SWEEPING LIGHT	
LIGHT	26	SWITCH (OPTION)	44
WATER TANK LOW LIGHT (OPTION)	26	FRONT NIGHT SWEEPING LIGHT	
VACUUM WAND DOOR LIGHT		SWITCH (OPTION)	44
(OPTION)	27	HIGH PRESSURE WASHER SWITCH	
HOPPER OVERLOAD LIGHT	27	(OPTION)	44
HEATER KNOB	27	DOME AND MAP LIGHT SWITCH ...	45
FAN KNOB	28	RADIO AND COMPACT DISK PLAYER	
AIR CONDITIONER KNOB (OPTION)	28	(OPTION)	45
		LATCHES	45

CONTENTS

	Page		Page
TRAFFIC ADVISOR SIGNAL LIGHT SWITCH (OPTION)	46	ENGINE	101
TRAFFIC ADVISOR SIGNAL LIGHT FUNCTION KNOB (OPTION)	46	COOLING SYSTEM	101
HOPPER SUPPORT PIN	47	AIR FILTER	102
HOPPER SUPPORT BAR (High Dump Model)	48	AIR INTAKE SCREEN	103
HOW THE MACHINE WORKS	49	FUEL FILTER	103
PRE-OPERATION CHECKLIST	50	FUEL WATER SEPARATOR	103
STARTING THE MACHINE	51	FUEL LINES	104
SWEEPING AND BRUSH INFORMATION	54	ENGINE VALVE	104
SWEEPING	55	CAB FILTERS	105
STOP SWEEPING	59	WET DUST CONTROL FILTER (OPTION)	105
EMPTYING THE HOPPER	61	WINDSHIELD WIPER BLADES	106
STOP THE MACHINE	65	WINDSHIELD WASHER FLUID	106
POST-OPERATION CHECKLIST	67	BATTERY	106
ENGAGING HOPPER SUPPORT PIN ..	68	BELTS AND CHAINS	107
DISENGAGING HOPPER SUPPORT PIN ..	70	ALTERNATOR/FAN BELTS	107
ENGAGING HOPPER SUPPORT BAR (High Dump Model)	71	AIR CONDITIONER BELT (OPTION) ..	107
DISENGAGING HOPPER SUPPORT BAR (High Dump Model)	73	STATIC DRAG CHAIN	107
OPERATION ON INCLINES	74	DEBRIS HOPPER	108
OPTIONS	75	HOPPER DUST FILTER	108
VARIO SWEEPING BRUSH	75	TO CLEAN THE HOPPER DUST FILTER	108
WET DUST CONTROL SYSTEM	77	TO REMOVE OR REPLACE HOPPER DUST FILTER	108
VACUUM WAND	79	THERMO SENTRY	109
CAB JACK	82	CONVEYOR	110
TILTING THE CAB (MANUALLY)	84	BRUSHES	111
MACHINE TROUBLESHOOTING	86	MAIN BRUSH	111
MAINTENANCE	88	TO REPLACE MAIN BRUSH	111
MAINTENANCE CHART	89	TO CHECK AND ADJUST MAIN BRUSH PATTERN	114
LUBRICATION	91	SIDE BRUSH	115
A. HOPPER TILT (LOW DUMP)	92	TO REPLACE SIDE BRUSH	115
B. HOPPER LIFT/TILT (HIGH DUMP OPTION)	92	SKIRTS AND SEALS	116
C. AXLE LEAF SPRINGS	92	BRUSH ACCESS DOOR SKIRTS ..	116
D. STEERING CYLINDER	93	DRY DUST CONTROL SKIRTS (OPTION)	116
E. WHEEL PIVOTS POINTS	93	BRUSH COMPARTMENT REAR SKIRT	116
F. SIDE BRUSH PIVOT	93	CONVEYOR SKIRTS	117
G. VARIO SWEEPING BRUSH (OPTION)	94	DOOR SEALS	117
H. CONVEYOR BEARINGS	94	CONVEYOR SEALS	118
I. CONVEYOR CHAIN	95	HOPPER SEALS	118
J. ENGINE	95	SKIDS	119
K. DIFFERENTIAL	96	BRAKES AND TIRES	119
L. MAIN BRUSH SUPPORT RODS ..	96	SERVICE BRAKES	119
HYDRAULICS	97	PARKING BRAKE	119
HYDRAULIC FLUID RESERVOIR ...	97	TIRES	120
REPLACING HYDRAULIC FLUID FILTER	98	WHEEL ALIGNMENT	120
HYDRAULIC FLUID	99	WHEEL NUTS	120
HYDRAULIC HOSES	100	PUSHING, TOWING, AND TRANSPORTING THE MACHINE ...	121
PURGING AIR FROM THE HYDRAULIC CONVEYOR LIFT SYSTEM	100	PUSHING OR TOWING THE MACHINE	121
		TRANSPORTING THE MACHINE	122
		MACHINE JACKING	124

	Page
STORING MACHINE	125
FREEZE PROTECTION FOR WET DUST CONTROL SYSTEM	125
FREEZE PROTECTION FOR THE HIGH PRESSURE WASHER OPTION	125
SPECIFICATIONS	126
GENERAL MACHINE DIMENSIONS/CAPACITIES	126
GENERAL MACHINE PERFORMANCE .	127
HYDRAULIC SYSTEM	127
POWER TYPE (S/N 000000-008499) ...	127
POWER TYPE (S/N 008500-)	128
STEERING	128
BRAKING SYSTEM	128
TIRES	128
MACHINE DIMENSIONS	129
INDEX	130

SAFETY PRECAUTIONS

The following precautions are used throughout this manual as indicated in their description:



WARNING: To warn of hazards or unsafe practices which could result in severe personal injury or death.











FOR SAFETY: To identify actions which must be followed for safe operation of equipment.

The machine is suited to sweep disposable debris. Do not use the machine other than described in this Operator Manual.

The following information signals potentially dangerous conditions to the operator or equipment:

FOR SAFETY:

1. **Do not operate machine:**
 - Unless trained and authorized.
 - Unless operation manual is read and understood.
 - In flammable or explosive areas unless designed for use in those areas.
2. **Before starting machine:**
 - Check for fuel leaks.
 - Keep sparks and open flame away from refueling area.
 - Make sure all safety devices are in place and operate properly.
 - Check brakes and steering for proper operation.
3. **When starting machine:**
 - Keep foot on brake and directional pedal in neutral.
4. **When using machine:**
 - Do not pick up burning or smoking debris, such as cigarettes, matches or hot ashes.
 - Use brakes to stop machine.
 - Go slow on inclines and slippery surfaces.
 - Use care when reversing machine.
 - Move machine with care when hopper is raised.
 - Only dump the hopper on a level surface.
 - Make sure adequate clearance is available before raising hopper.
 - Do not carry riders on machine.
 - Always follow safety and traffic rules.
 - Report machine damage or faulty operation immediately.
5. **Before leaving or servicing machine:**
 - Stop on level surface.
 - Set parking brake.
 - Turn off machine and remove key.
6. **When servicing machine:**
 - Avoid moving parts. do not wear loose jackets, shirts, or sleeves.
 - Block machine tires before jacking machine up.
 - Jack machine up at designated locations only. Block machine up with jack stands.
 - Use hoist or jack that will support the weight of the machine.
 - Wear eye and ear protection when using pressurized air or water.
 - Disconnect battery connections before working on machine.
 - Avoid contact with battery acid.
 - Avoid contact with hot engine coolant.
 - Allow engine to cool.
 - Keep flames and sparks away from fuel system service area. Keep area well ventilated.
 - Use cardboard to locate leaking hydraulic fluid under pressure.
 - Use Tennant supplied or approved replacement parts.
7. **When loading/unloading machine onto/off truck or trailer:**
 - Turn off machine.
 - Use truck or trailer that will support the weight of the machine.
 - Use winch. Do not drive the machine onto/off the truck or trailer unless the load height is 380 mm (15 in) or less from the ground.
 - Set parking brake after machine is loaded.
 - Block machine tires.
 - Tie machine down to truck or trailer.

-  **WARNING: Machine can emit excessive noise. Consult with your regulatory agency for exposure limits. Hearing loss can result. Wear hearing protection.**
-  **WARNING: Raised hopper may fall. Engage hopper support bar.**
-  **WARNING: Raised hopper may fall. Engage hopper support pin.**
-  **WARNING: Brush linkage pinch points. Stay clear when linkage is moving.**
-  **WARNING: Side brush can move. Do not step on side brush.**
-  **WARNING: Hopper door pinch point. Stay clear of hopper door.**
-  **WARNING: High dump vertical clearance. Stay clear of overhead obstructions and power lines.**
-  **WARNING: Conveyor throws debris. Conveyor pinch point. Stay clear when in operation.**
-  **WARNING: Flammable materials can cause explosion or fire. Do not use flammable materials in tank. Only use water.**
-  **WARNING: Engine emits toxic gases. Severe respiratory damage or asphyxiation can result. Provide adequate ventilation. Consult with your regulatory agency for exposure limits. Keep engine properly tuned.**
-  **WARNING: Lift arm pinch point. Stay clear of hopper lift arms.**
-  **WARNING: Raised cab may fall. Engage cab support bar.**
-  **WARNING: Do not spray people or animals. Severe personal injury can result. Wear eye protection. Hold sprayer with two hands.**

SAFETY PRECAUTIONS

The following safety labels are mounted on the machine in the locations indicated. If these or any label becomes damaged or illegible, install a new label in its place.

EMISSIONS LABEL -
Located on the upper console.



HIGH DUMP LABEL -
Located on the upper console.



FOR SAFETY LABEL -
Located on the upper console.



HIGH PRESSURE SPRAY HAZZARD LABEL - Located on the frame of machine.

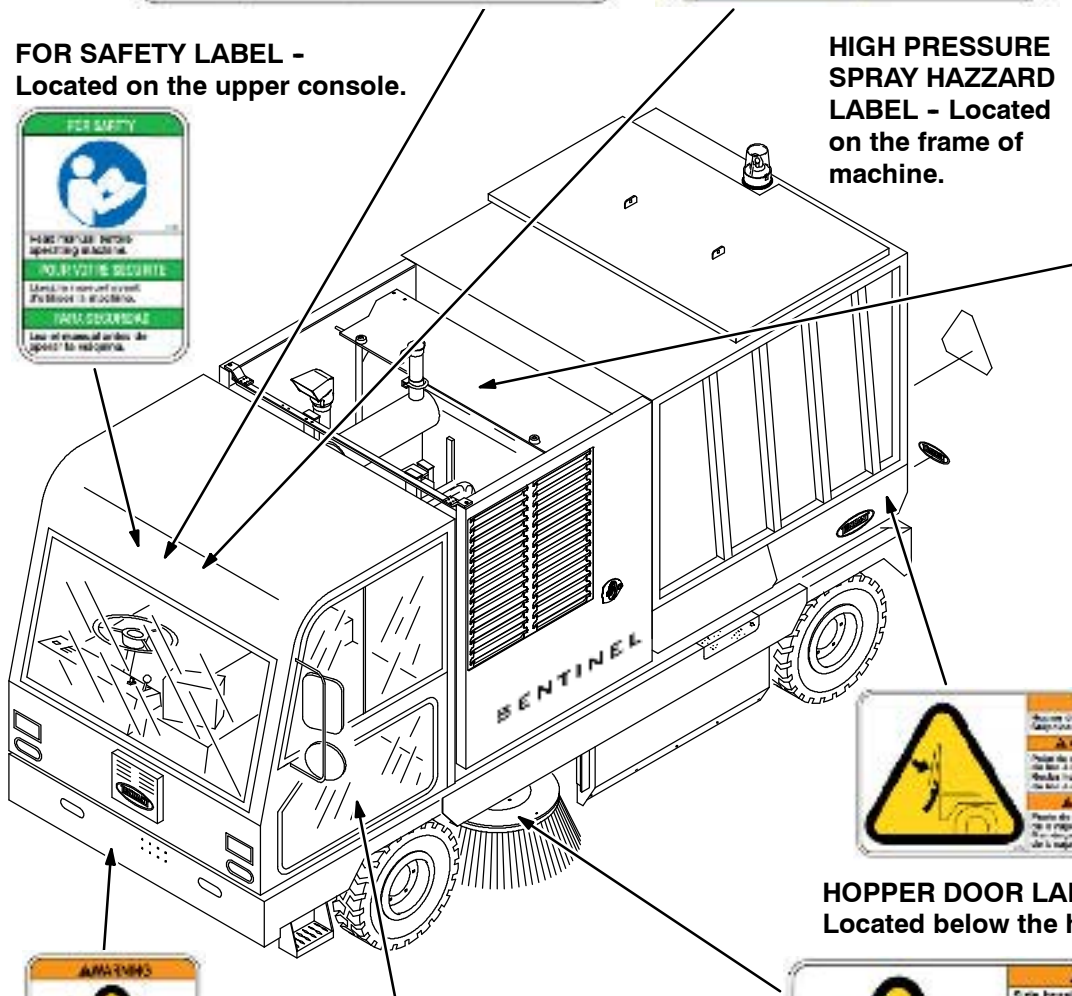

HOPPER DOOR LABEL -
Located below the hopper door.



BRUSH LINKAGE LABEL (VARIO SWEEPING BRUSH) -
Located on the front of the machine.



RAISED CAB LABEL -
Located below the cab on the frame.



SIDE BRUSH LABEL -
Located above the side brush(es).

HOPPER SUPPORT PIN LABEL -
 Located on both sides of the support pin.
 On low dump models, one is located on the upper support cylinder.
 On high dump models, one is located on the drivers side of the hopper lift.



FLAMMABLE MATERIALS LABEL (Wet Dust Control Option) -
 Located on the drivers side below the water fill spout.



CONVEYOR LABEL -
 Located at the back of the conveyor.



VACUUM WAND OPTION NOISE LABEL -
 Located on the vacuum wand.



HOPPER SUPPORT BAR LABEL (High Dump) - Located on both sides of the support bar, on the rear center of the hopper lift, and on both sides of the hopper lift.

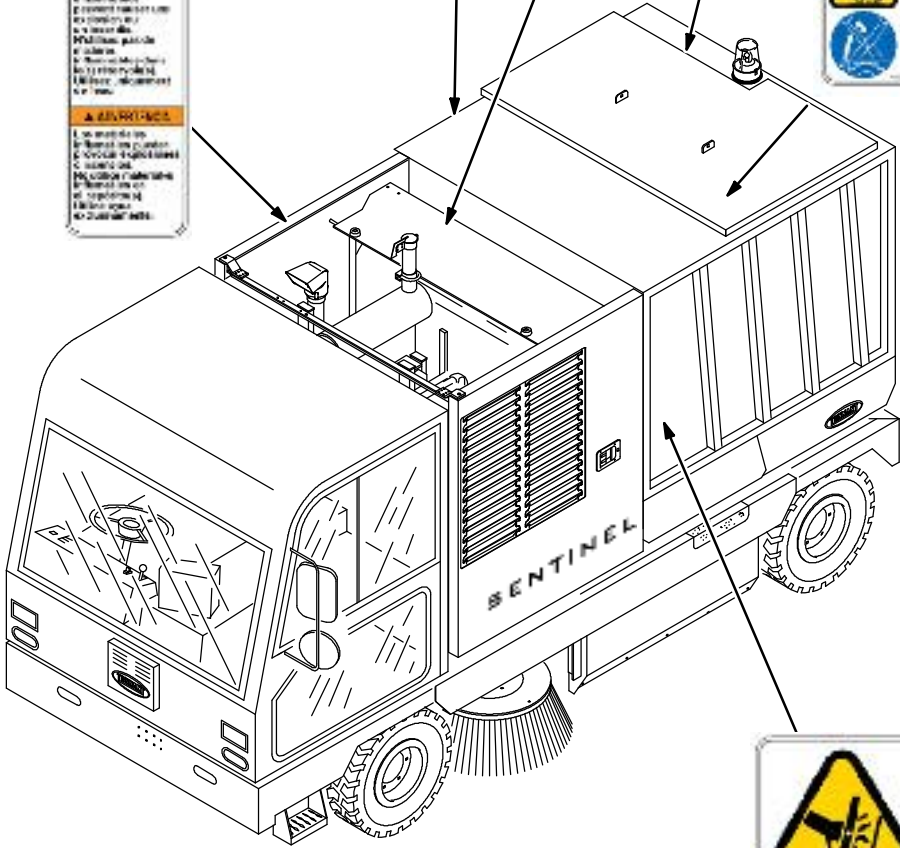

LIFT ARMS LABEL (High Dump) -
 Located on the side of the hopper lift.

OPERATOR RESPONSIBILITY

- The operator's responsibility is to take care of the daily maintenance and checkups of the machine to keep it in good working condition. The operator must inform the service mechanic or supervisor when the required maintenance intervals occur as stated in the *MAINTENANCE* section of this manual.
- Read this manual carefully before operating this machine. View the operation video supplied with the machine.

FOR SAFETY: Do not operate machine, unless operation manual is read and understood.

- Check the machine for shipping damage. Check to make sure machine is complete per shipping instructions.
- Keep your machine regularly maintained by following the maintenance information in this manual. We recommend taking advantage of a regularly scheduled service contract from your TENNANT representative.
- Order parts and supplies directly from your authorized TENNANT representative. Use the parts manual provided when ordering parts.
- The model SENTINEL has a GVWR of 9072 kg (20,000 lb) or 4536 kg (10,000 lb) per axle. Operate only on surfaces capable of supporting this weight.

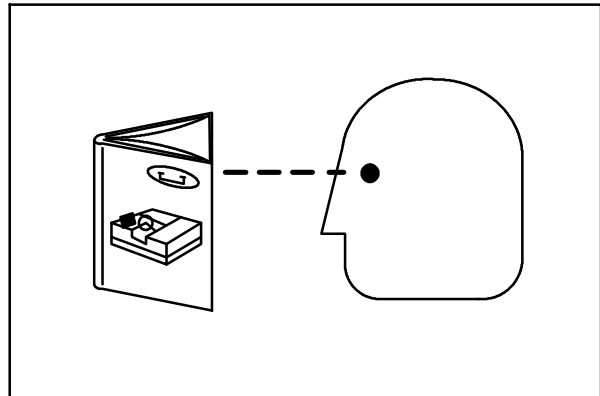

07324

MACHINE COMPONENTS

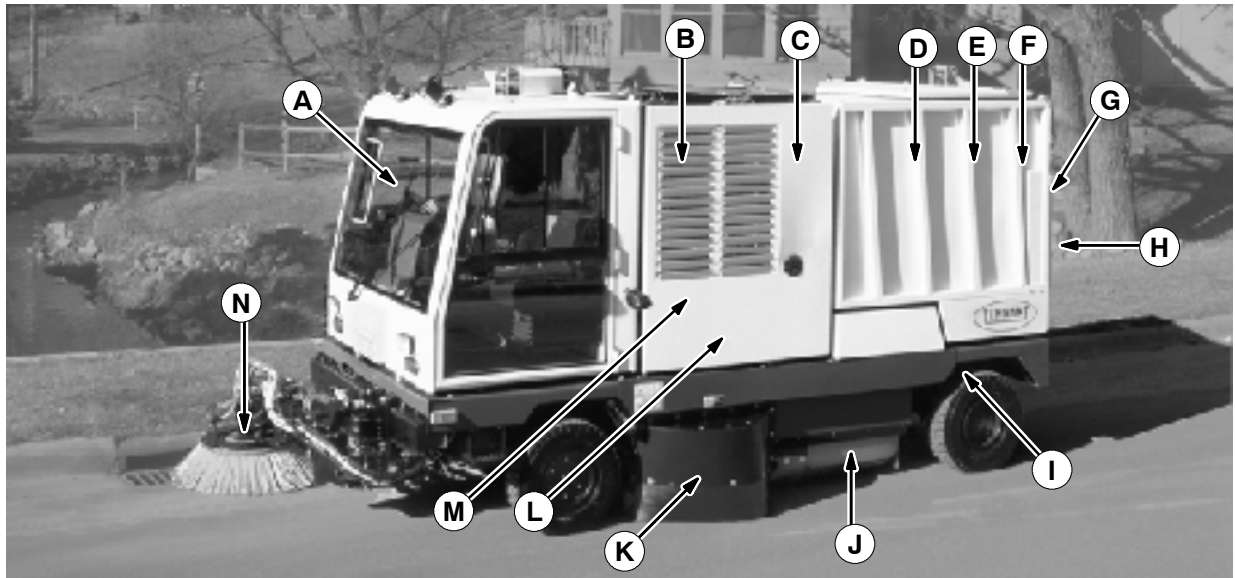

- A. Cab
- B. Diesel Engine
- C. Conveyor
- D. Hopper
- E. Dust Filters
- F. Vacuum Fan
- G. Hopper Door
- H. Vacuum Wand (Option)
- I. Hopper Lift
- J. Main Brush
- K. Side Brush(es)
- L. Water Tank (right side)
- M. Fuel Tank (right side)
- N. Vario Sweeping Brush (Option)

OPERATION

CONTROL PANEL SYMBOLS

These symbols identify controls and displays on the machine:



Vario Sweeping Brush



Vario Sweeping Brush Arm



Vario Sweeping Brush Front Tilt Down



Vario Sweeping Brush Front Tilt Up



Vario Sweeping Brush Side Tilt Left



Vario Sweeping Brush Side Tilt Right



Vario Sweeping Brush Arm Slide Left



Vario Sweeping Brush Arm Slide Right



Vario Sweeping Brush Arm Swing Left



Vario Sweeping Brush Arm Swing Right



Vario Sweeping Brush Up-Down



Vario Sweeping Brush Rotation



Forward



Reverse



Fast Engine Speed



Idle Engine Speed



Bright Headlights



Parking Brake



Signal Light



Glow Plug (Preheat)



Clogged Engine Air Cleaner



Water Tank Low



Vacuum Wand Door



Hopper Overload



Heater



Fan



Air Conditioner



Flow Rate



Incline Light



Low Brake Pressure



Engine Shutdown Override



Water Spray



Left Side Brush



Right Side Brush



Engine Water Temperature



Fuel



Engine Oil Pressure



Voltmeter



Hourmeter



Brush Down



Hopper Tilt Back



Hopper Tilt Forward



Hopper Lift



Hopper Lower



Hopper Door Open



Hopper Door Close



Left Side Brush



Right Side Brush



Filter Shaker



Conveyor Reverse



Sweep



4-way Warning Lights



Hazard Light



Side Brush Spot Light



Rear Night Sweeping Light



Front Night Sweeping Light



High Pressure Washer

OPERATION

CONTROLS AND INSTRUMENTS

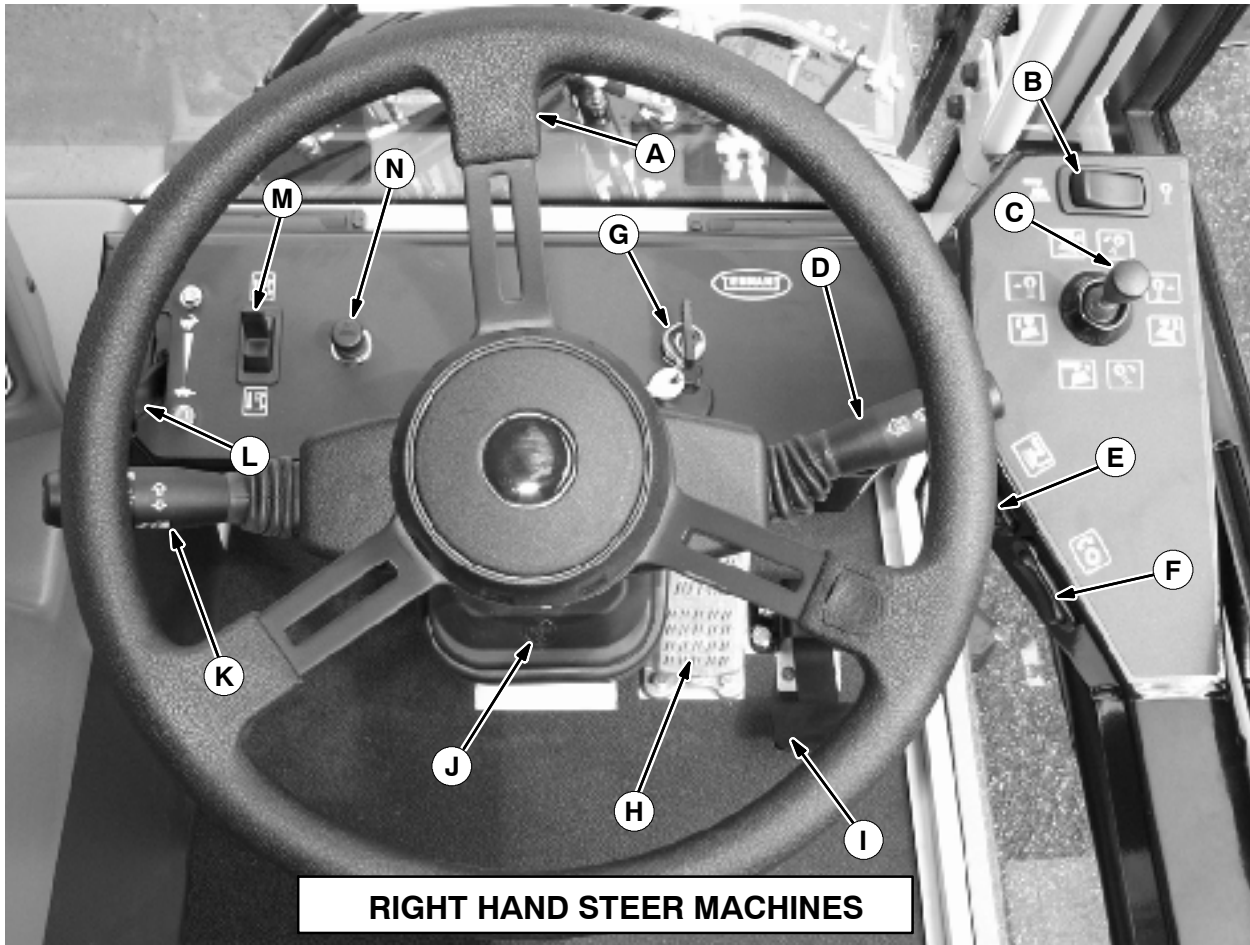

- A. Steering Wheel
- B. Vario Sweeping Brush Tilt/Arm Switch (Option)
- C. Vario Sweeping Brush Joystick (Option)
- D. Windshield Wiper And Washer Switch
- E. Vario Sweeping Brush Raise-Lower Switch (Option)
- F. Vario Sweeping Brush On-Off Switch (Option)
- G. Ignition Switch
- H. Brake Pedal
- I. Propelling Pedal
- J. Steering Wheel Tilt Lever
- K. Parking Lights, Headlights, Bright Headlights, Signal And Horn Switch
- L. Throttle Lever
- M. Directional Lever
- N. Accessory Power Socket

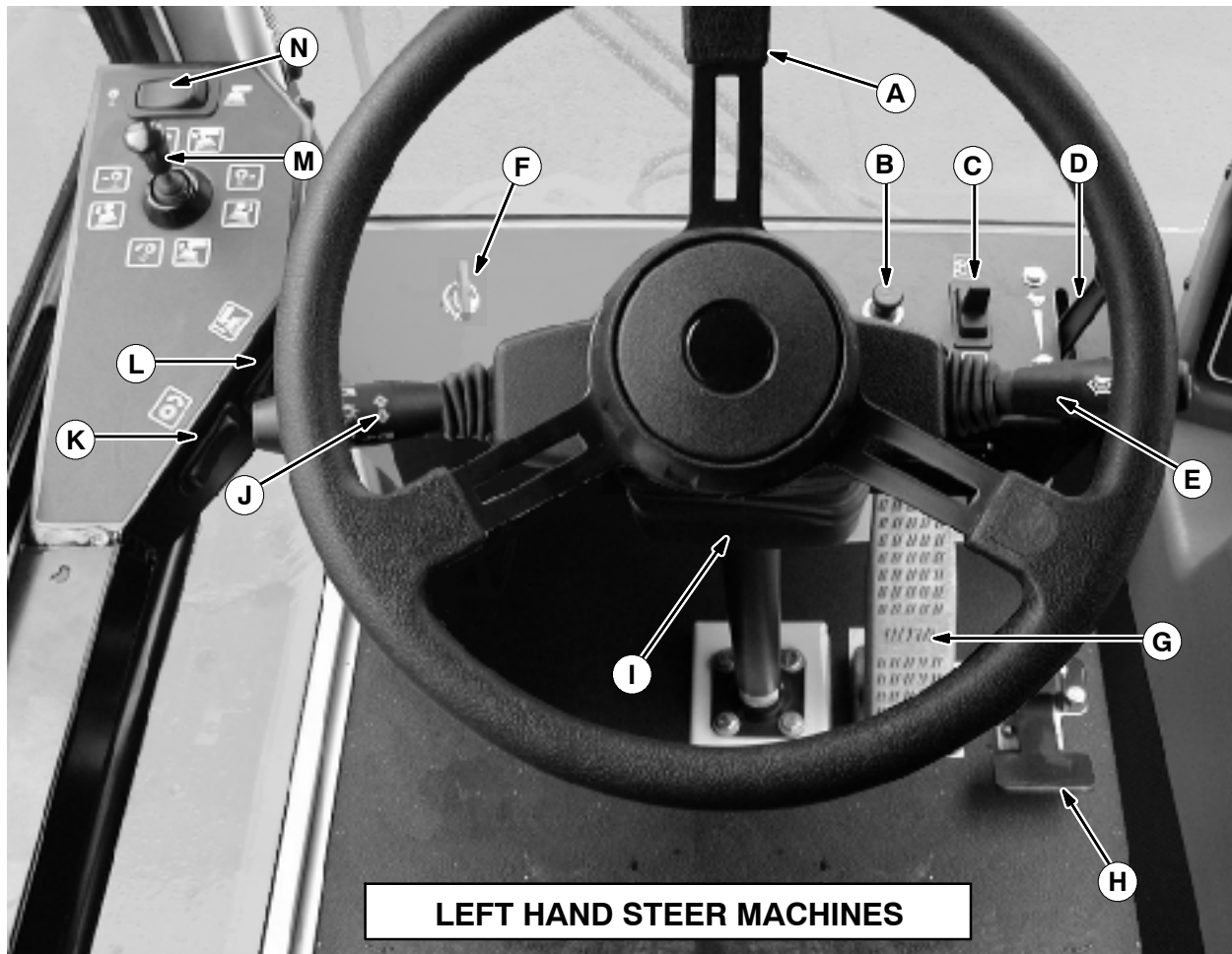

- A. Steering Wheel
- B. Accessory Power Socket
- C. Directional Lever
- D. Throttle Lever
- E. Windshield Wiper And Washer Switch
- F. Ignition Switch
- G. Brake Pedal
- H. Propelling Pedal
- I. Steering Wheel Tilt Lever
- J. Parking Lights, Headlights, Bright Headlights, Signal And Horn Switch
- K. Vario Sweeping Brush On-Off Switch (Option)
- L. Vario Sweeping Brush Raise-Lower Switch (Option)
- M. Vario Sweeping Brush Joystick (Option)
- N. Vario Sweeping Brush Tilt/Arm Switch (Option)

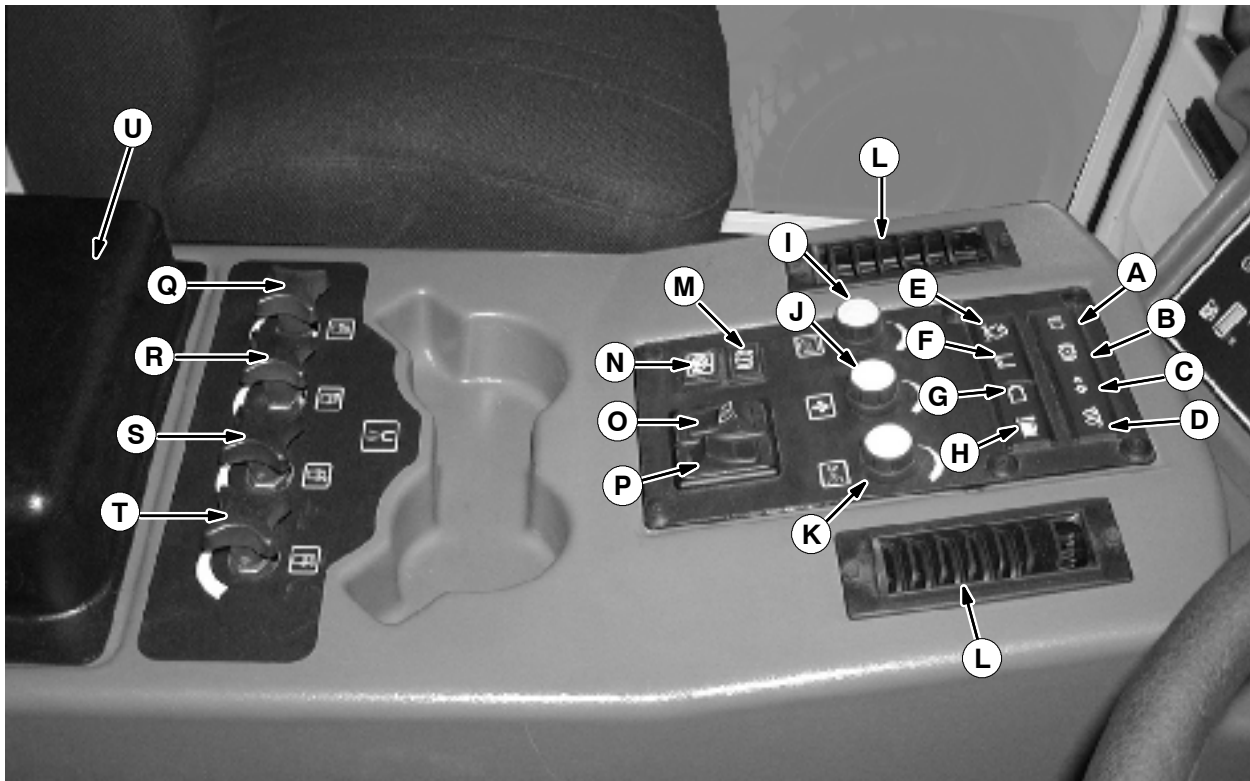

- A. Bright Headlights Light
- B. Parking Brake Light
- C. Signal Light
- D. Glow Plugs Light
- E. Clogged Engine Air Cleaner Light
- F. Water Tank Low Light (Option)
- G. Vacuum Wand Door Light (Option)
- H. Hopper Overload Light
- I. Heater Knob
- J. Fan Knob
- K. Air Conditioner Knob (Option)
- L. Air Circulation Vents
- M. Low Brake Pressure Light
- N. Incline Light (High Dump Model)
- O. Engine Shutdown Override Switch
- P. Parking Brake Switch
- Q. Left Side Brush Water Valve Knob (Option)
- R. Vario Sweeping Brush Left Water Valve Knob (Option)
- S. Vario Sweeping Brush Right Water Valve Knob (Option)
- T. Right Side Brush Water Valve Knob (Option)
- U. Fuses (Under cover)

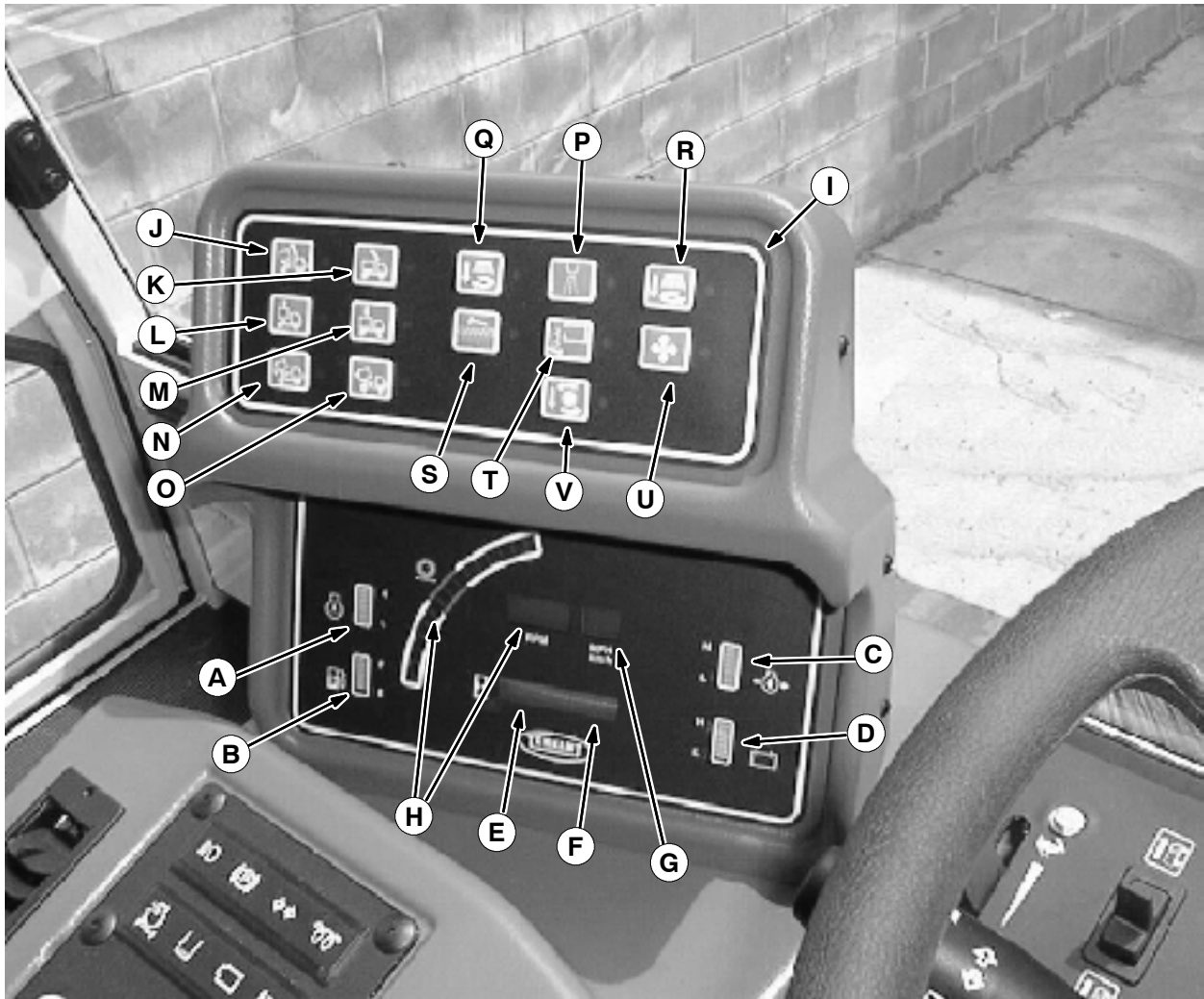

- A. Engine Water Temperature Gauge
- B. Fuel Level Gauge
- C. Engine Oil Pressure Gauge
- D. Voltmeter
- E. Hourmeter
- F. Odometer
- G. Speedometer
- H. Tachometer
- I. Switch Panel
- J. Hopper Tilt Back Switch
- K. Hopper Tilt Forward Switch
- L. Hopper Lift Switch (High Dump Model)
- M. Hopper Lower Switch (High Dump Model)
- N. Hopper Door Open Switch
- O. Hopper Door Close Switch
- P. Water Pump Switch (Option)
- Q. Left Side Brush Switch
- R. Right Side Brush Switch
- S. Filter Shaker Switch
- T. Conveyor Reverse Switch
- U. Vacuum Fan Switch
- V. Sweep Switch

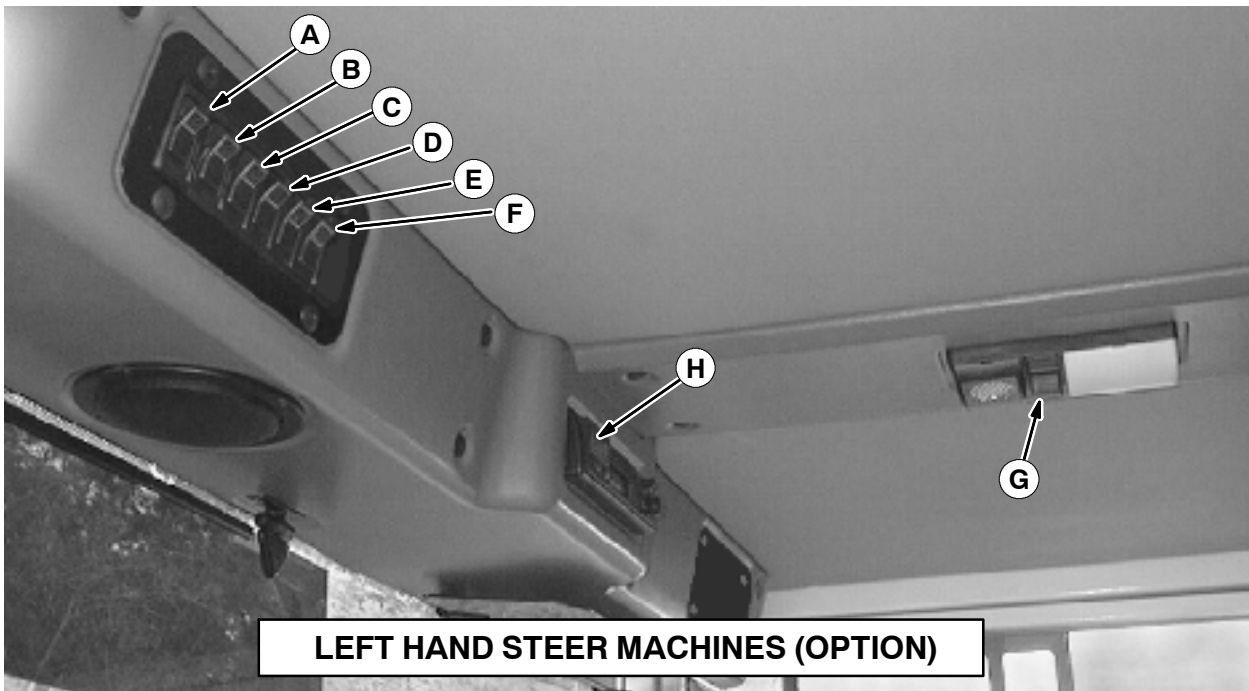
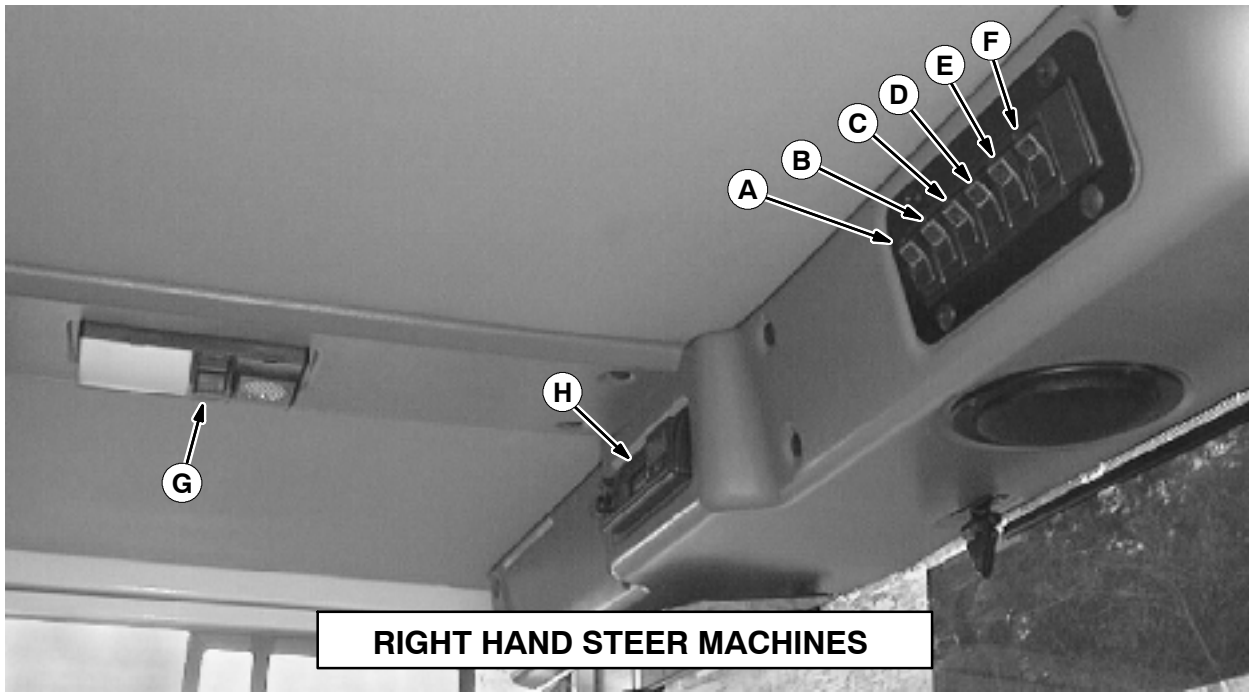

- A. 4-way Warning Lights Switch
- B. Hazard Light Switch
- C. Side Brush Spot Light(s) Switch
- D. Rear Night Sweeping Light Switch (Option)
- E. Front Night Sweeping Light Switch (Option)
- F. High Pressure Washer Switch (Option)
- G. Dome Light And Map Switch
- H. Radio And Cassette Player (Option)

OPERATION OF CONTROLS

OPERATOR SEAT

The *operator seat* has two adjustments. The adjustments are for the front to rear seat position and ride stiffness.

NOTE: The machine will not propel unless the operator is in the seat.

The seat front-to-rear position is adjusted by the seat position lever.

Adjust: Push the lever to the left, slide the seat backward or forward to the desired position and release the lever.

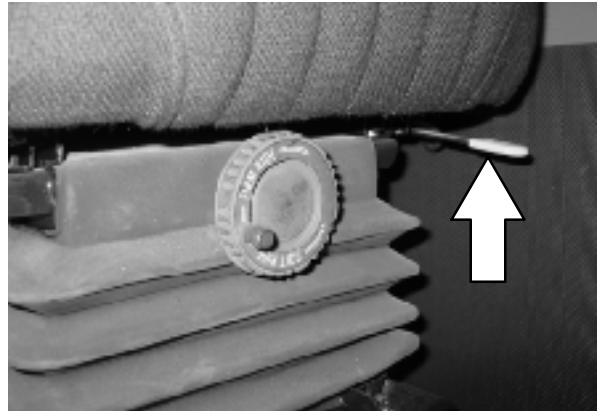

The ride stiffness is adjusted with the stiffness knob.

Adjust: Turn the knob clockwise to increase the ride stiffness, and counter-clockwise to decrease the ride stiffness.

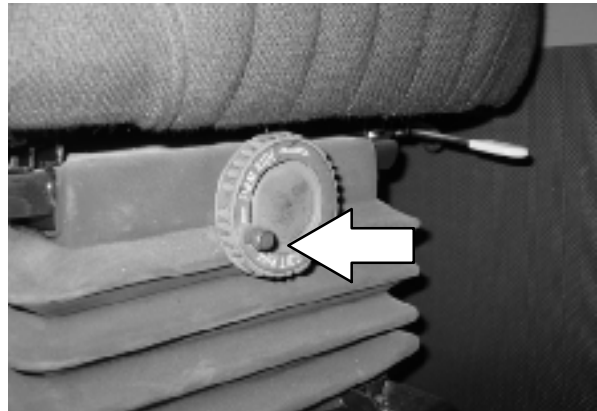

SEAT BELTS

The *seat belts* are located on each seat. Always fasten the *seat belts* and adjust them for proper fit before operating the machine.



OPERATION

STEERING WHEEL

The *steering wheel* controls the machine's direction. The machine is very responsive to the steering wheel movements.

Left: Turn the steering wheel to the left.

Right: Turn the steering wheel to the right.

NOTE: The machine has 4-wheel steering. Watch the swing of the rear corners of the machine when turning.



STEERING WHEEL TILT LEVER (For machines serial number 007053 and below)

The *steering wheel tilt lever* is used to adjust the angle of the steering wheel. To tilt the steering wheel, pull the lever slightly downward and toward the operator seat. Position the steering wheel at the desired position, then release the lever.

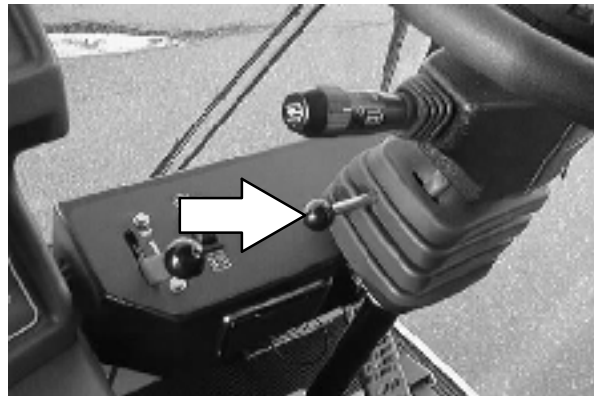

STEERING WHEEL TILT LEVER (For machines serial number 007054 and above)

The *steering wheel tilt lever*, located under the steering boot, is used to adjust the angle of the steering wheel. To tilt the steering wheel, push straight in on lever under the boot. Position the steering wheel at the desired position, then release the lever.

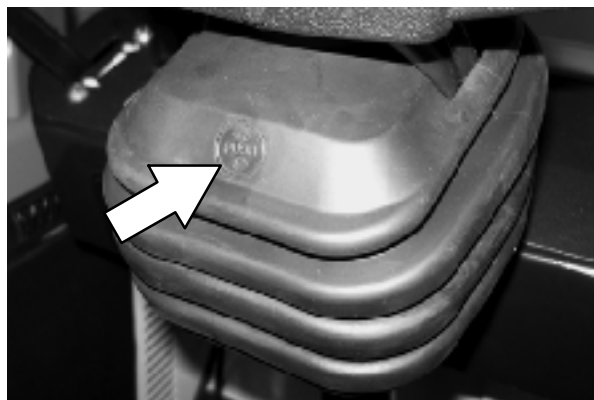

PARKING LIGHTS, HEADLIGHTS, BRIGHT HEADLIGHTS, SIGNAL, AND HORN SWITCH

The *parking lights, headlights, bright headlights, signal, and horn switch* controls the parking lights, headlights, signals, and horn.

Parking and Headlights On: Rotate the switch knob counter-clockwise.

Parking Lights On: Turn the switch knob to the first click.

Headlights On: Turn the switch knob to the second click.

Bright Headlights On: Push the switch lever down.

Bright Headlights Off: Pull the switch lever up.

Flash Bright Headlights: Pull the switch lever up, then release.

Signals: Push the switch lever forward for the right signal. Pull the switch lever back for the left signal.

Horn: Push the switch end towards the steering column.

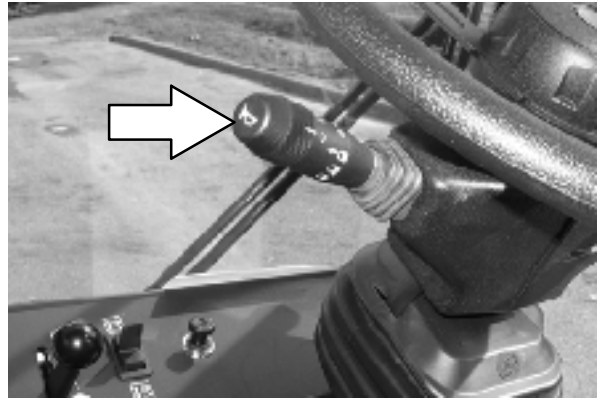

WINDSHIELD WIPER AND WASHER SWITCH

The *windshield wiper and washer switch* controls the windshield wipers and windshield washer fluid spray.

Windshield Wipers Off: Push the lever all the way down.

Windshield Wipers Slow Speed: Pull the switch lever to the first position.

Windshield Wipers Slow Speed: Pull the switch lever to the second position.

Windshield Washer Fluid Spray: Push the switch lever end in.

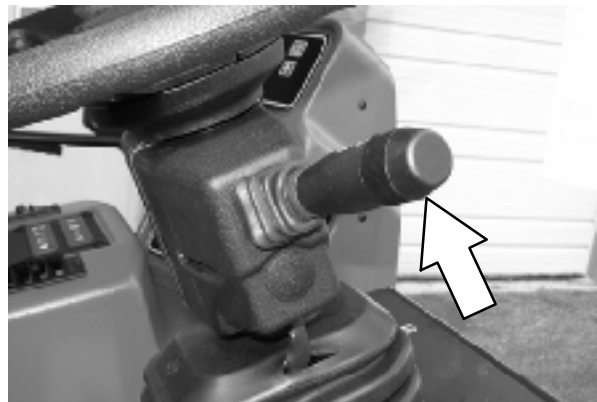

OPERATION

IGNITION SWITCH (For machines serial number 007709 and below)

The *ignition switch* starts and stops the engine with a key. When the ignition switch is turned off, the parking brake will come on automatically.

Preheat: Turn the key counter-clockwise. The glow plugs light will come on. When the glow plug light goes out, usually for 5 to 30 seconds depending on the weather conditions, the engine is ready to start.

NOTE: The preheat is not necessary if the temperature is above 10° C (50° F).

Start: Turn the key all the way clockwise. Release the key as soon as the engine starts.

Stop: Turn the key counter-clockwise.

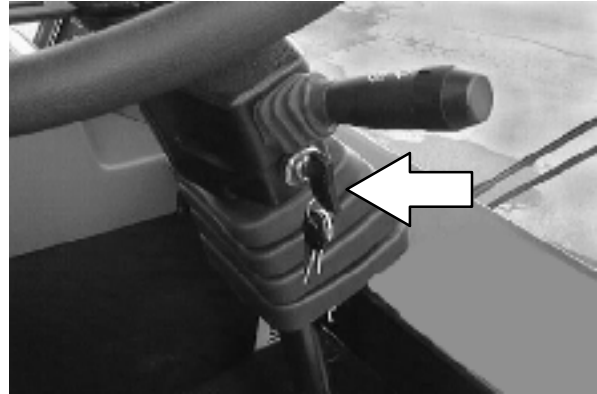

IGNITION SWITCH (For machines serial number 007710 and above)

The *ignition switch* starts and stops the engine with a key. When the ignition switch is turned off, the parking brake will come on automatically.

Preheat: Turn the key counter-clockwise. The glow plugs light will come on. When the glow plug light goes out, usually for 5 to 30 seconds depending on the weather conditions, the engine is ready to start.

NOTE: The preheat is not necessary if the temperature is above 10° C (50° F).

Start: Turn the key all the way clockwise. Release the key as soon as the engine starts.

Stop: Turn the key counter-clockwise.

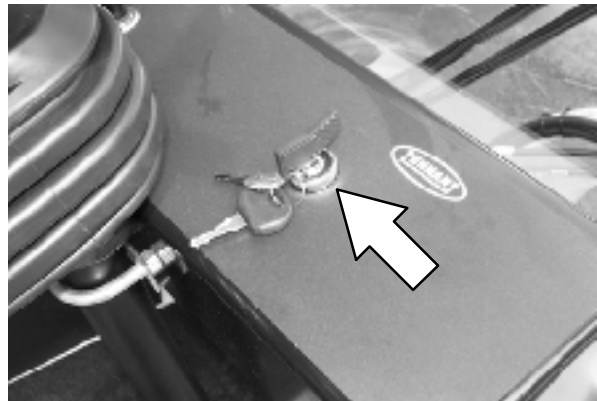

PROPELLING PEDAL

The *propelling pedal* controls the propelling speed of the machine. You change the speed of the machine with the pressure of your foot; the harder you press the pedal, the faster the machine travels. The travel speed is indicated with the speedometer. See the *SPEEDOMETER* section of this manual.

NOTE: The machine's travel speed is limited to 5 mph when the hopper is tilted or raised.

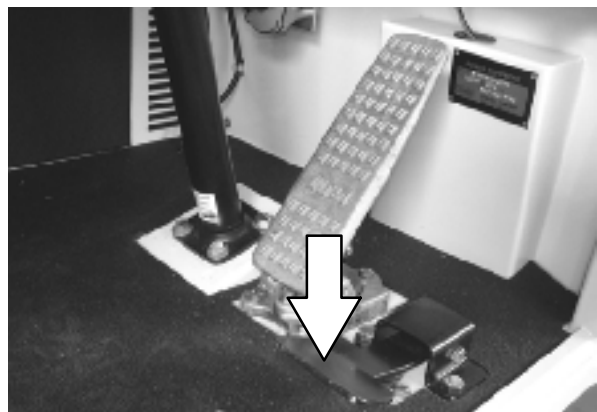

BRAKE PEDAL

The *brake pedal* stops the machine.

NOTE: The hopper lift and tilt switches will not operate unless the parking brake is set or the service brake is applied.

Stop: Take your foot off the propelling pedal and step on the brake pedal.

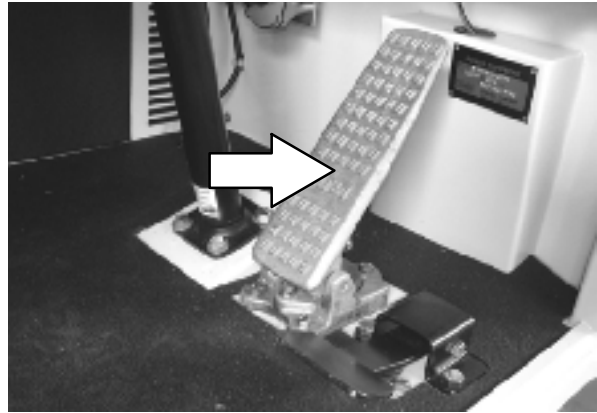
**ACCESSORY POWER SOCKET**

The *accessory power socket* can be used as a cigarette lighter or as an electrical accessory power outlet.

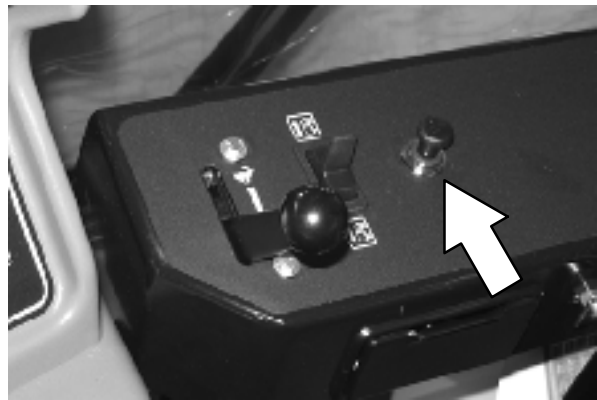
**DIRECTIONAL LEVER**

The *directional lever* controls the forward-reverse direction of travel of the sweeper.

Neutral: Place the lever in the middle, or *Neutral* position.

FOR SAFETY: When starting machine, keep foot on brake and directional lever in neutral.

Forward: Push the lever up into the *Forward* position.

NOTE: Machine will not start unless the directional lever is in the neutral position. The machine will not propel with the parking brake on.

Reverse: Pull the lever down into the *Reverse* position.



OPERATION

THROTTLE LEVER

The *throttle lever* controls the engine RPM. Move the throttle lever till the tachometer shows the desired engine RPM for transporting or sweeping. See the *TACHOMETER* section of this manual.

Fast: Push the lever forward.

Idle: Pull the lever backward.

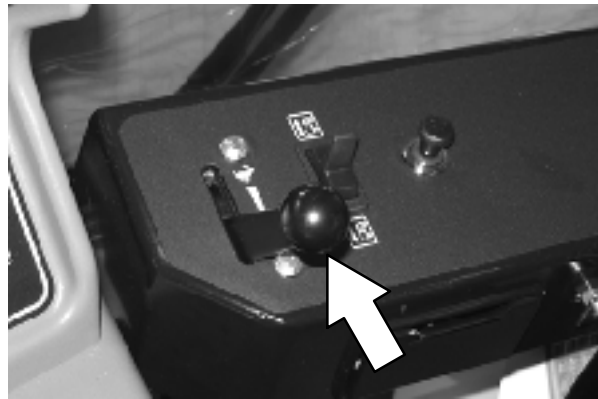

VARIO SWEEPING BRUSH LOCK PIN (OPTION)

The *Vario Sweeping Brush lock pin* keeps the brush arm locked in the storage position during transport of the machine, or when the brush is not being used. Unlock the brush arm before using the *Vario Sweeping Brush*.

Unlock: Pull out the hair cotter pin out of the end of the lock pin.

Lock: Insert the lock pin and secure with the hair cotter pin.

 **WARNING: Brush linkage pinch points. Stay clear when linkage is moving.**

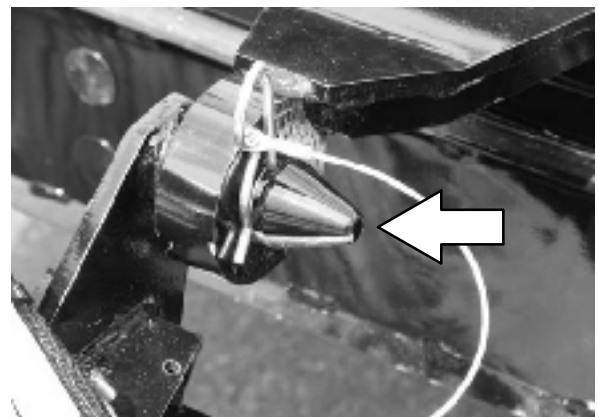

VARIO SWEEPING BRUSH TILT/ARM SWITCH (OPTION)

The *Vario Sweeping Brush tilt/arm switch* transfers the joystick control between the sweeping brush tilt controls and the sweeping brush arm movement controls.

Brush Tilt: Press the left side of the switch to control the brush tilt with the joystick.

Brush Arm: Press the right side of the switch to control the brush arm movement with the joystick.



VARIO SWEEPING BRUSH JOYSTICK (OPTION)

The *Vario Sweeping Brush joystick* controls the Vario Sweeping Brush tilt and the Vario Sweeping Brush™ arm movement.

When the *Vario Sweeping Brush tilt/arm switch* is set to the brush tilt position, the *Vario Sweeping Brush joystick* will control the angle of the sweeping brush.

Tilt Brush Front Edge Down: Move and hold the lever forward until the brush has moved into the desired position.

Tilt Brush Rear Edge Down: Move and hold the lever back until the brush has moved into the desired position.

Tilt Brush Left: Move and hold the lever to the left until the brush has moved into the desired position.

Tilt Brush Right: Move and hold the lever to the right until the brush has moved into the desired position.

⚠ WARNING: Brush linkage pinch points. Stay clear when linkage is moving.

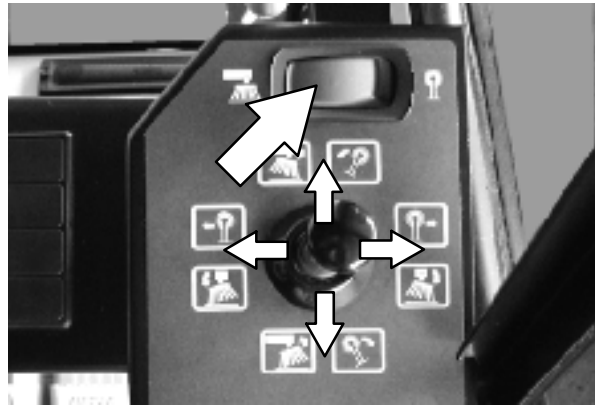

When the *Vario Sweeping Brush tilt/arm switch* is set to the sweeping brush arm position, the *Vario Sweeping Brush joystick* will control the movement of the sweeping brush arm.

Swing Sweeping Brush Arm Left: Move and hold the lever forward until the arm swings into the desired position.

Swing Sweeping Brush Arm Right: Move and hold the lever back until the arm swings into the desired position.

Slide Sweeping Brush Arm Left: Move and hold the lever to the left until the arm slides into the desired position.

Slide Sweeping Brush Arm Right: Move and hold the lever to the right until the arm slides into the desired position.

⚠ WARNING: Brush linkage pinch points. Stay clear when linkage is moving.

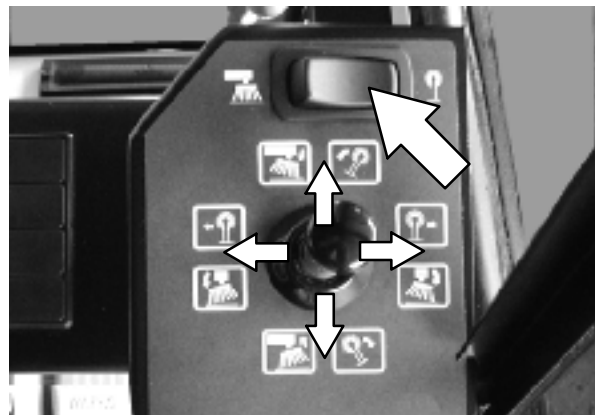

OPERATION

VARIO SWEEPING BRUSH ON-OFF SWITCH (OPTION)

The *Vario Sweeping Brush on-off switch* controls the power of the sweeping brush and also determines the direction of brush rotation.

On (right hand sweep): Push the right side of the switch. The brush will turn on and rotate in a counter-clockwise direction.

On (left hand sweep): Push the left side of the switch. The brush will turn on and rotate in a clockwise direction.

Off: Place the switch in the middle position. The brush turn off.



VARIO SWEEPING BRUSH RAISE-LOWER SWITCH (OPTION)

The *Vario Sweeping Brush raise-lower switch* controls the height of the sweeping brush.

Lower brush: Push the left side of the switch. The brush will lower to ground level into the free-floating position.

Raise brush: Press and hold the right side of the switch. Release the switch when the brush is raised to the desired height.



BRIGHT HEADLIGHTS LIGHT

The *bright headlights light* comes on when the headlights are on the bright setting.

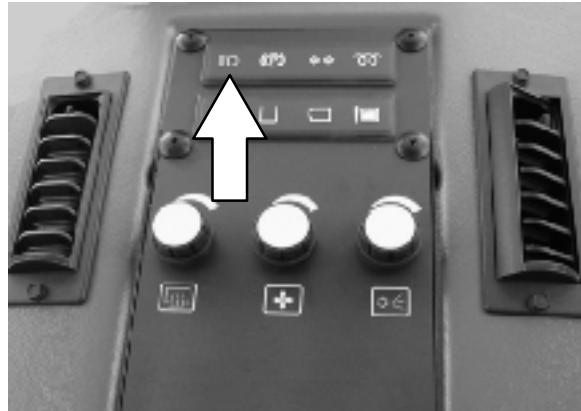
**PARKING BRAKE LIGHT**

The *parking brake light* comes on when the parking brake is set. The light on the parking brake switch will also come on when the parking brake is set. Refer to the *PARKING BRAKE SWITCH* section of this manual.

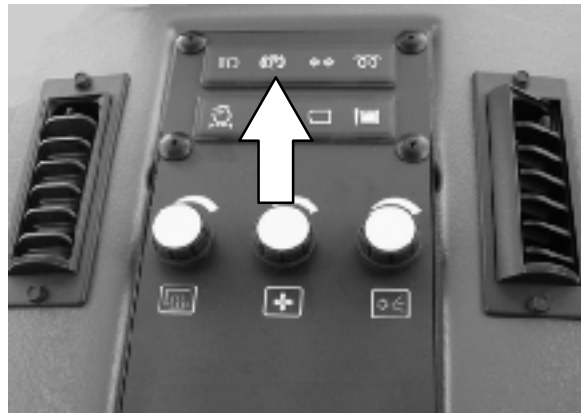
**SIGNAL LIGHT**

The *signal light* arrows flash when the turn signals are used or when the 4-way warning lights are on.

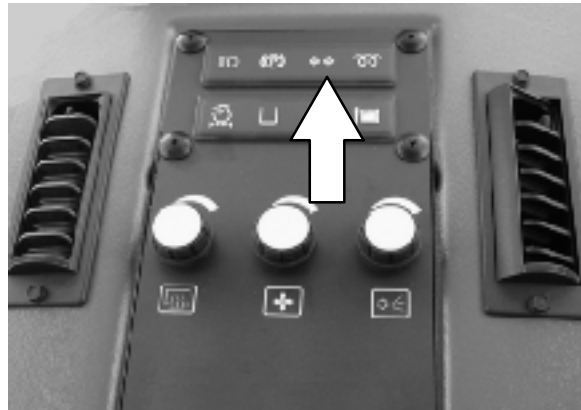

OPERATION

GLOW PLUG LIGHT

The *glow plug light* comes on when the ignition switch is turned counter-clockwise to the accessories position. The light will go out when the engine is ready to start, usually 5 to 30 seconds depending on the weather conditions.

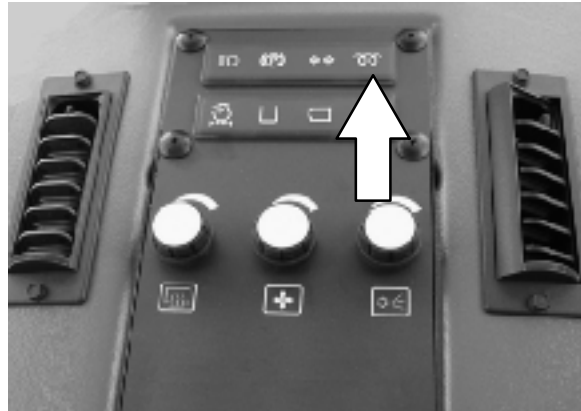

CLOGGED ENGINE AIR FILTER LIGHT

The *clogged engine air filter light* comes on when the engine air filter gets clogged. To clean the filter, see *AIR FILTER* in the *MAINTENANCE* section of this manual.

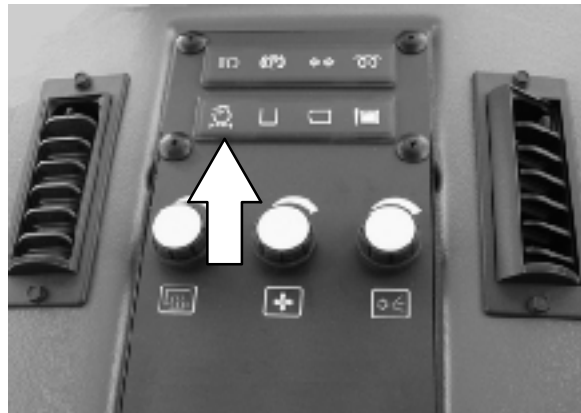

WATER TANK LOW LIGHT (OPTION)

The *water tank low light* comes on when the water tank level is low. The water pump will shut off soon after this light comes on. If the machine is equipped with a high pressure washer option, it's pump will also shut off if this light comes on.



WARNING: Flammable materials can cause explosion or fire. Do not use flammable materials in tank. Only use water.

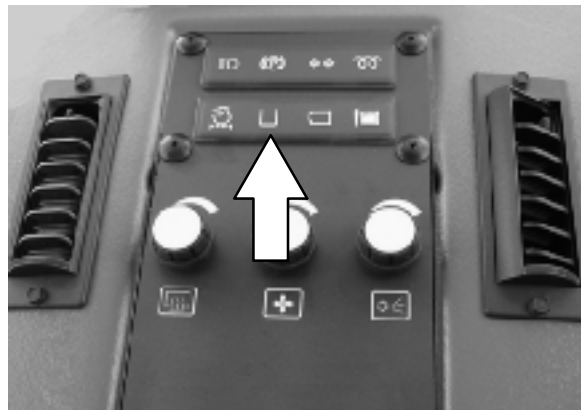

VACUUM WAND DOOR LIGHT (OPTION)

The *vacuum wand door light* comes on when the vacuum wand door is closed. Make sure the vacuum wand door is open and the vacuum wand door light is off before sweeping with the machine.

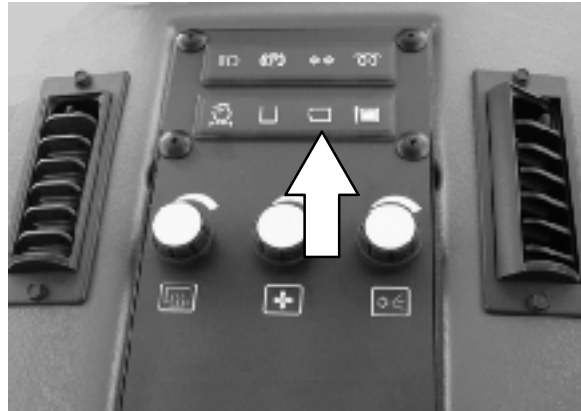
**HOPPER OVERLOAD LIGHT**

The *hopper overload light* comes on when the hopper reached it's weight capacity.

For high dump machines, the hopper light will come on when loaded with more than 1815 kg (4000 lb). When the hopper overload light is on, the hopper can only be tilted to low dump.

For low dump machines, the hopper light will come on when loaded with more than 3175 kg (7000 lb). The hopper should be dumped when the overload light comes on.

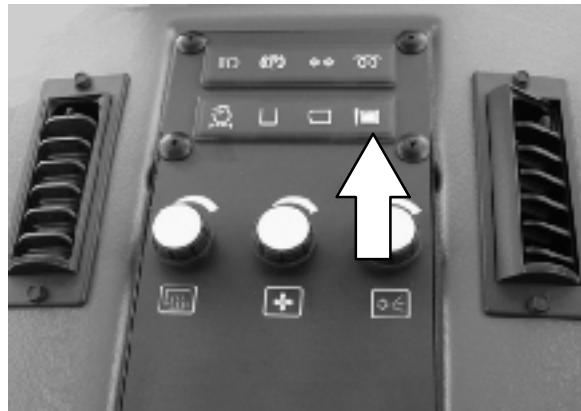
**HEATER KNOB**

The *heater knob* controls the heater temperature.

Increase: Turn the heater knob clockwise.

Decrease: Turn heater the knob counter-clockwise.

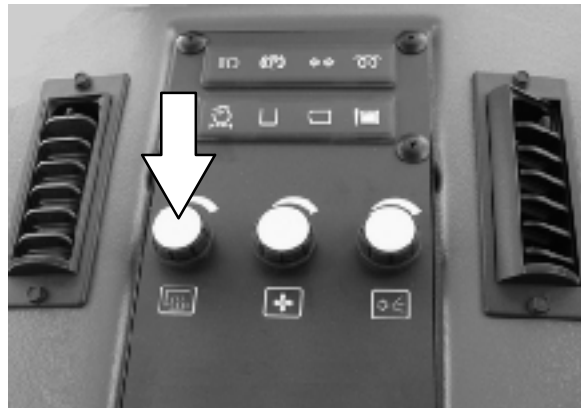

OPERATION

FAN KNOB

The *fan knob* controls the fan speed for the heater and air conditioner.

Increase: Turn the fan knob clockwise.

Decrease: Turn the fan knob counter-clockwise.

NOTE: This switch does not turn off when the ignition is turned off.

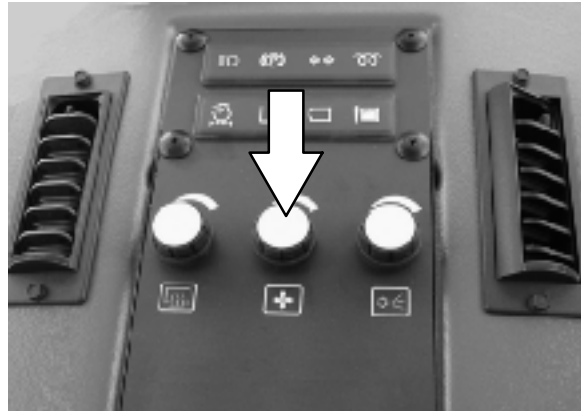

AIR CONDITIONER KNOB (OPTION)

The *air conditioner knob* controls the air conditioner temperature.

Increase The Cool Temperature: Turn the air conditioner knob clockwise.

Decrease The Cool Temperature: Turn air conditioner the knob counter-clockwise.

NOTE: The air conditioner will NOT work unless the fan is turned on.

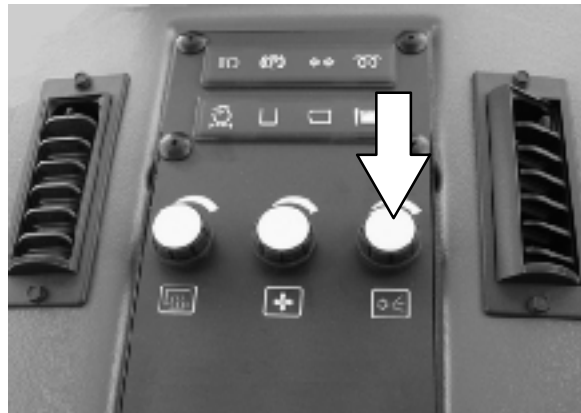

AIR CIRCULATION VENTS

There are numerous *air circulation vents* in the operator cab. There is a set for both the passenger and the driver. If desired, the vents can be closed on the passenger side of the cab for more air flow to the drivers side of the cab. The vents in front of the dash panel are for defrosting.

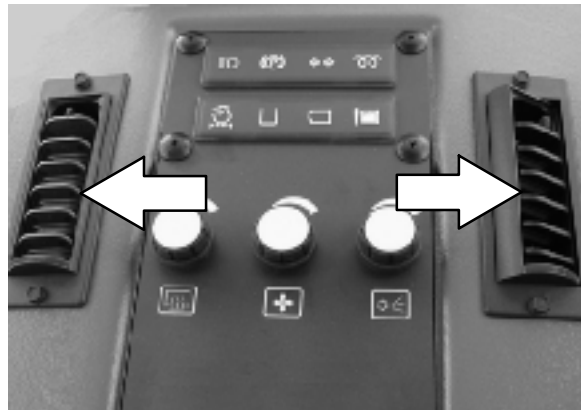

LOW BRAKE PRESSURE LIGHT

The *low brake pressure light* indicates low brake pressure. If this light comes on when the machine is started, do not move the machine until the light goes out. If the light comes on during operation of the machine, proceed with caution out of intersections or traffic and park the machine. If brake pressure drops too low, the parking brake will come on automatically and will not release until brake pressure is restored. Contact your service personnel to restore the brake pressure.

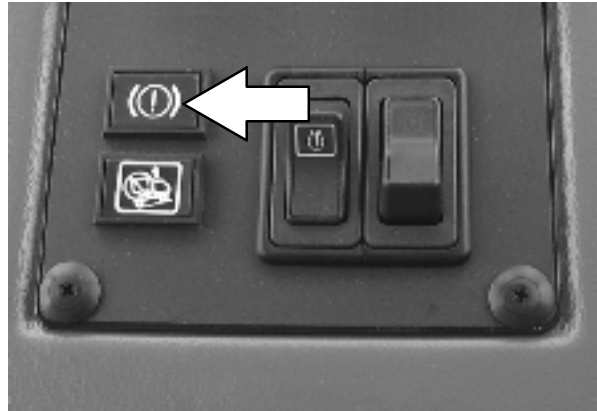

INCLINE LIGHT (High Dump Model)

The *incline light* will come on when the machine is on an incline that is unsafe for high dumping the hopper. It will come on when the front to back incline is more than 11° and the side to side incline is more than 4° . The machine will not high dump when this light is on.

FOR SAFETY: Only dump the hopper on a level surface.

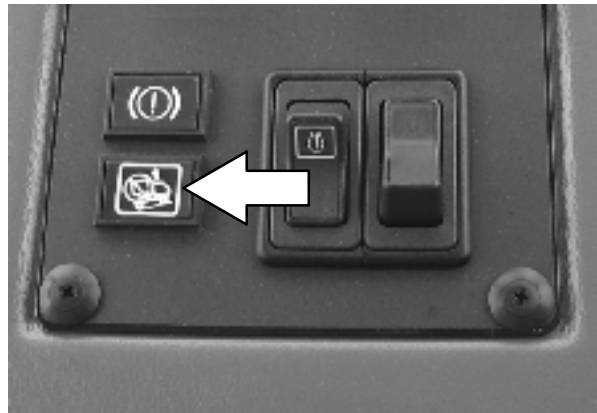

OPERATION

ENGINE SHUTDOWN OVERRIDE SWITCH

The *engine shutdown override switch* will bypass the high water temperature and low oil pressure shutdown feature. Press and hold the switch both to start and operate the machine. This switch is for use if the machine's automatic shutdown feature happens in an intersection or in traffic. Do NOT use this switch for more than a few seconds or damage to the engine could occur. See *ENGINE WATER TEMPERATURE GAUGE* and *ENGINE OIL PRESSURE GAUGE* sections of this manual.

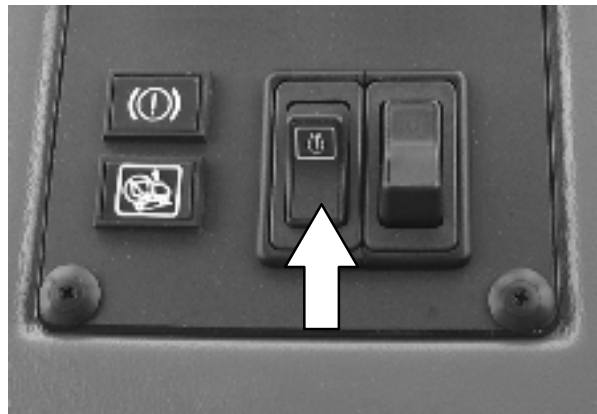

PARKING BRAKE SWITCH

The *parking brake switch* sets and releases the front axle as well as disables the propelling system. When the ignition switch is turned off, the parking brake will come on automatically.

NOTE: The hopper lift and tilt switches will not operate unless the parking brake is set or the service brake is applied.

NOTE: The high pressure washer option will not operate unless the parking brake is set.

Set: Press the top part of the parking brake switch. The indicator light in the switch as well as the parking brake light will come on.

FOR SAFETY: Before leaving or servicing machine, stop on level surface, set parking brake, turn off machine and remove key.

Release: Press the bottom part of the parking brake switch. The indicator light in the switch as well as the parking brake light will turn off.

NOTE: If brake pressure drops too low, the parking brake will come on automatically and will not release until brake pressure is restored. When this happens, this switch will NOT indicate that it is set. See LOW BRAKE PRESSURE LIGHT section of this manual.

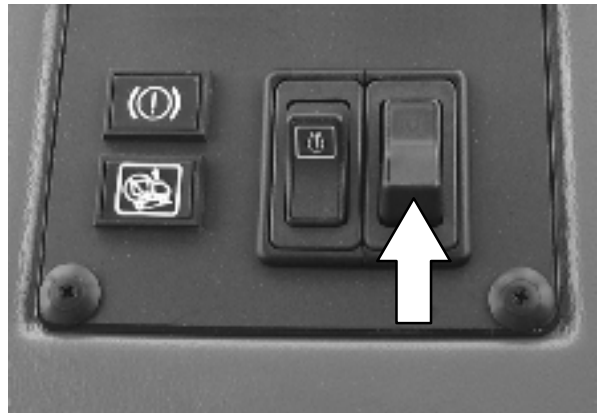

LEFT SIDE BRUSH WATER VALVE KNOB (OPTION)

The *left side brush water valve knob* controls the amount of water spray to the left side brush.

Increase Water Spray: Turn the left side brush water valve knob counter-clockwise.

Decrease Water Spray: Turn the left side brush water valve knob clockwise.

Stop Water Spray: Turn the water valve knob clockwise until it comes to a complete stop to close the water supply. If this is NOT done when the machine is shut off, water will continue to flow.

NOTE: The water pump switch needs to be on for the water valves to operate.

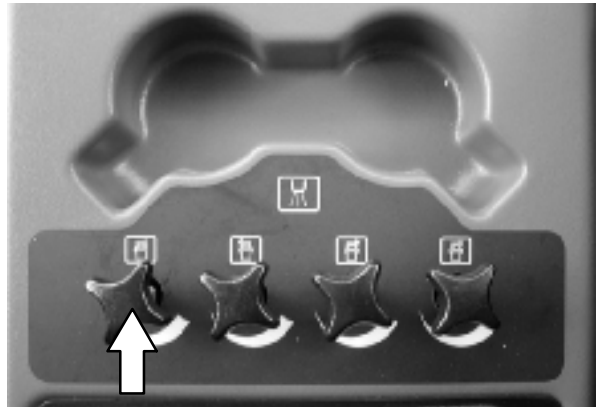

VARIO SWEEPING BRUSH LEFT WATER VALVE KNOB (OPTION)

The *Vario Sweeping Brush left water valve knob* controls the amount of water spray to the sweeping brush when it is on left side of the machine.

Increase Water Spray: Turn the water valve knob counter-clockwise.

Decrease Water Spray: Turn the water valve knob clockwise.

Stop Water Spray: Turn the water valve knob clockwise until it comes to a complete stop to close the water supply. If this is NOT done when the machine is shut off, water will continue to flow.

NOTE: The water pump switch needs to be on for the water valves to operate.

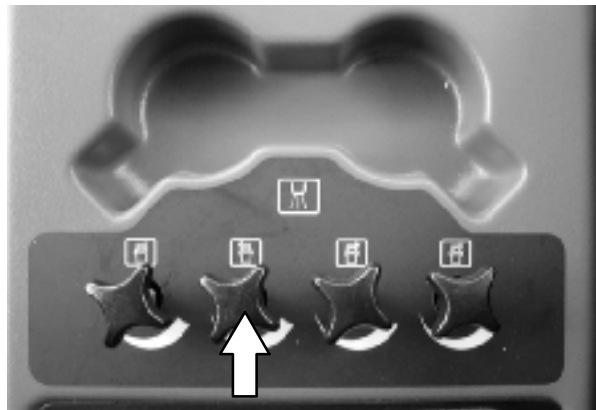

OPERATION

VARIO SWEEPING BRUSH RIGHT WATER VALVE KNOB (OPTION)

The *Vario Sweeping Brush* right water valve knob controls the amount of water spray to the sweeping brush when the it is on the right side of the machine.

Increase Water Spray: Turn the water valve knob counter-clockwise.

Decrease Water Spray: Turn the water valve knob clockwise.

Stop Water Spray: Turn the water valve knob clockwise until it comes to a complete stop to close the water supply. If this is NOT done when the machine is shut off, water will continue to flow.

NOTE: The water pump switch needs to be on for the water valves to operate.

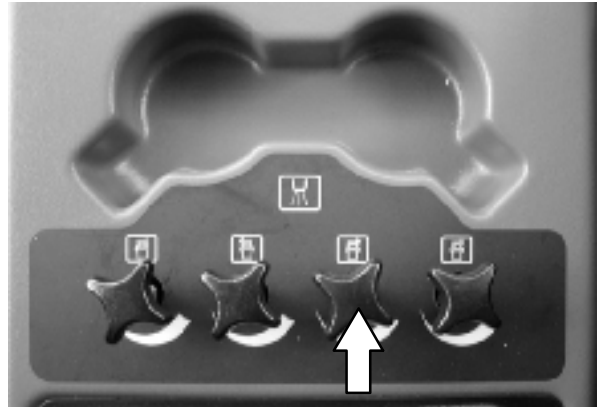

RIGHT SIDE BRUSH WATER VALVE KNOB (OPTION)

The *right side brush water valve knob* controls the amount of water spray to the right side brush.

Increase Water Spray: Turn the right side brush water valve knob counter-clockwise.

Decrease Water Spray: Turn the right side brush water valve knob clockwise.

Stop Water Spray: Turn the water valve knob clockwise until it comes to a complete stop to close the water supply. If this is NOT done when the machine is shut off, water will continue to flow.

NOTE: The water pump switch needs to be on for the water valves to operate.

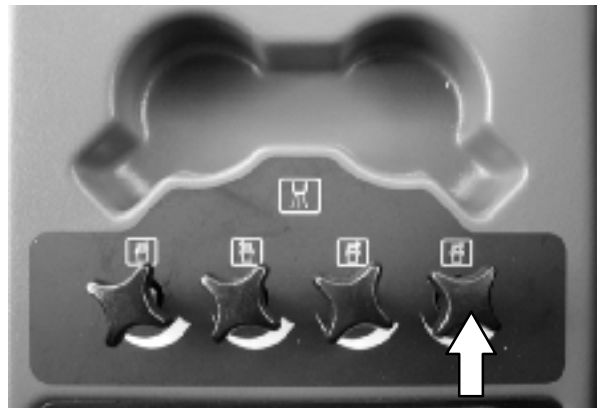

FUSES

Fuses are a one-time protection device designed to stop the flow of current in the event of a circuit overload. This machine uses automotive ATO type fuses. **Never substitute higher value fuses than specified.**

The fuses are located in the fuse box under the fuse cover on the center console.

Fuse	Rating	Circuit Protected
FU-1	30 A	Accessory
FU-2	30 A	Accessory
FU-3	25 A	Turn Signals
FU-4	15 A	Night Lights
FU-5	20 A	Rotating / Sidebrush
FU-6	20 A	Headlight
FU-7	15 A	Taillight / Marker
FU-8	10 A	Water Pump
FU-9	15 A	Accessory Power Socket
FU-10	10 A	Horn
FU-11	10 A	Domelight / Radio
FU-12	5 A	Auto Lube (option)
FU-13		Traffic Advisor
FU-14		Open
FU-15	30 A	Heater / Air Conditioner
FU-16	15 A	Logic Power
FU-17	15 A	Hopper Control
FU-18	10 A	Logic
FU-19	10 A	Sensors
FU-20		Key Cntrld Optn (Open)
FU-21		Key Cntrld Optn (Open)
FU-22		Traffic Advisor
FU-23	10 A	Auto Lube (option)
FU-24	10 A	Vario Front Brush
FU-25	10 A	Radio
FU-26	10 A	Wipers
FU-27	15 A	Neutral Start Propel
FU-28	15 A	Daytime Running Lights
FU-29	80 A	Preheat



OPERATION

ENGINE WATER TEMPERATURE GAUGE

The *engine water temperature gauge* shows the engine coolant temperature. If the engine coolant temperature is too hot, the LED indicator light will blink. If this happens, stop the engine, locate the problem and have it corrected. If the engine is not turned off, the machine is equipped with an automatic shutdown feature that will turn off the engine. This keeps the engine from being damaged. To override this automatic shutdown, refer to the *ENGINE SHUTDOWN OVERRIDE SWITCH* section of this manual.

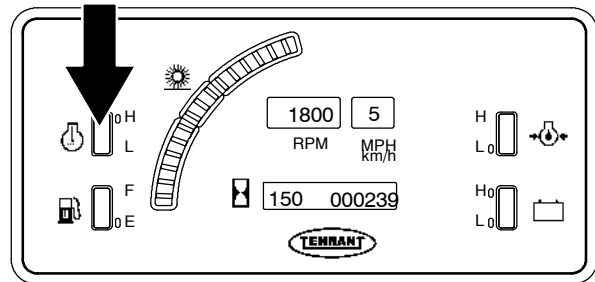

351927

FUEL LEVEL GAUGE

The *fuel level gauge* indicates how much fuel is in the fuel tank. The LED indicator light will blink when the fuel level is low.

NOTE: Do not let the fuel tank empty completely. Air can enter the fuel system and require bleeding, before the next engine start.

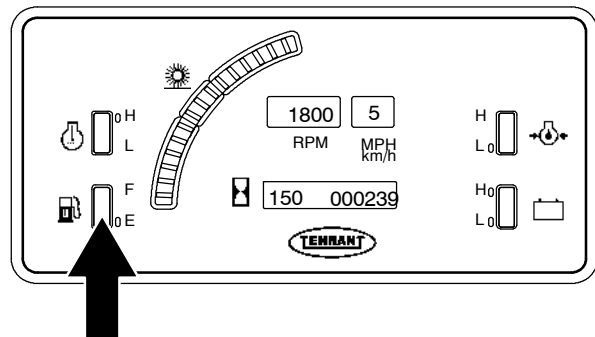

351927

ENGINE OIL PRESSURE GAUGE

The *engine oil pressure gauge* displays the engine oil pressure. If the oil pressure falls too low, the LED light will blink. If this happens, stop the engine, locate the problem and have it corrected. If the engine is not turned off, the machine is equipped with an automatic shutdown feature that will turn off the engine. This keeps the engine from being damaged. To override this automatic shutdown, refer to the *ENGINE SHUTDOWN OVERRIDE SWITCH* section of this manual.

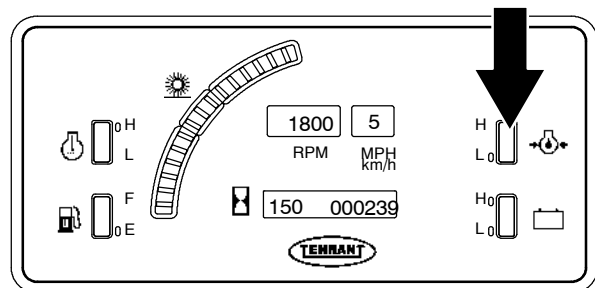

351927

VOLTMETER

The *voltmeter* displays the existing voltage of the battery. When the voltage is not within the normal range - 12 to 14 Volts, the LED light will blink. If this happens, stop operating the machine, locate the problem and have it corrected.

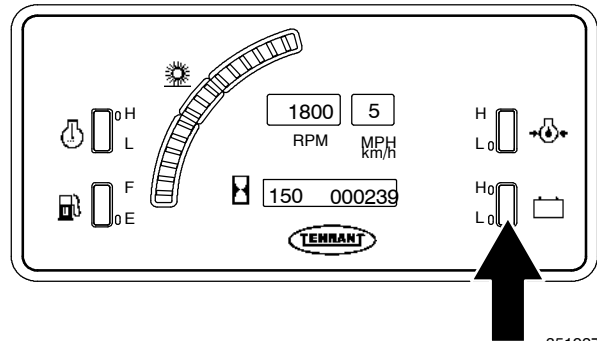

351927

HOURLMETER

The *hourmeter* records the number of hours the machine has been operated. Use this information to determine machine maintenance intervals.

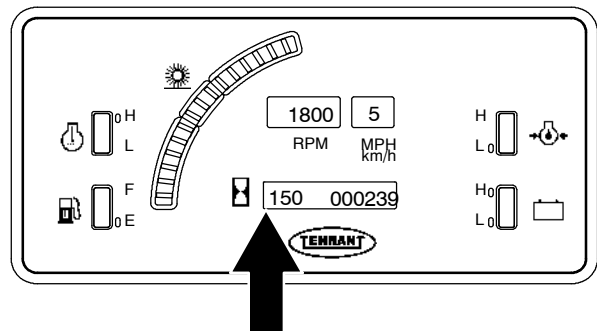

351927

ODOMETER

The *odometer* records the distance that the machine has been driven. Use this information to determine machine maintenance intervals such as tire wear.

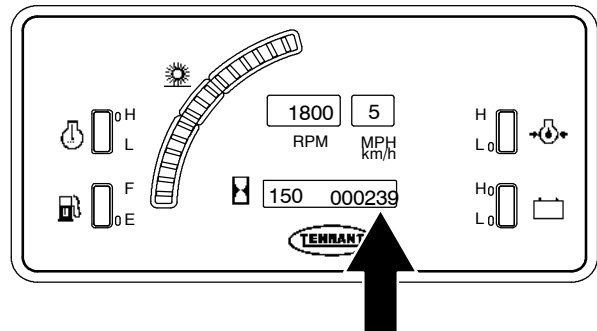

351927

SPEEDOMETER

The *speedometer* displays the machines travel speed. Use this for determining the proper operating speed for sweeping and transporting.

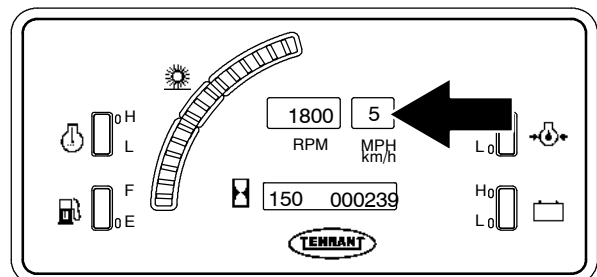

351927

OPERATION

TACHOMETER

The *tachometer* consists of a numeric display, an LED visual display, and a green *SWEEP* light. The numeric display shows the engine RPM. Move the throttle lever till the tachometer shows the desired engine RPM for transporting or sweeping. See the *THROTTLE LEVER* section of this manual.

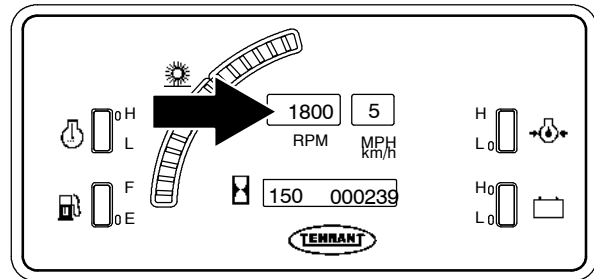

351927

The tachometer's LED visual display indicates when the engine RPM is set for proper sweeping. When the amber LED light is in the middle of the gauge (between the blue markings), the engine throttle is at a proper setting for sweeping. The desired sweeping speed is between 1600 and 2000 RPM. Refer to the chart in the *SWEEPING* section.

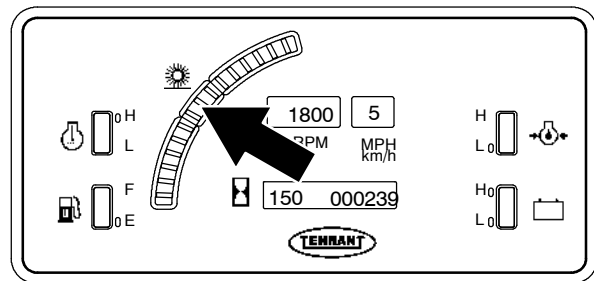

351927

The tachometer's green *SWEEP* light will illuminate when the engine RPM is set for proper sweeping. If the engine speed is operating below 1600 RPM, the green *SWEEP* light will turn off while the sweeping functions will continue to operate. If the engine speed is operating too fast for sweeping (above 2000 RPM), the green *SWEEP* light will blink and an audio alarm will sound. This will continue for 15 seconds, then the sweeping functions will stop and raise.

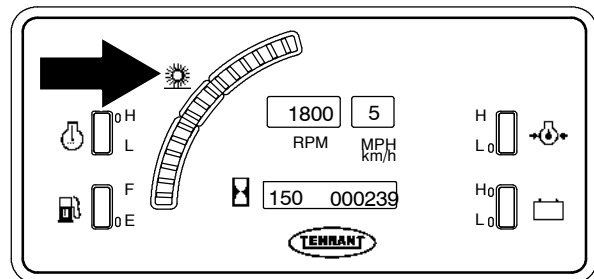

351927

SWITCH PANEL

The *switch panel* contains the switches that control the hopper and sweeping functions. It is located on the front center part of the cab.



HOPPER TILT BACK SWITCH

The *hopper tilt back switch* tilts the hopper back for dumping debris. It will also stop and raise the sweeping functions. The machine's travel speed is limited to 5 mph when the hopper is tilted.

NOTE: The hopper lift and tilt switches will not operate unless the parking brake is set or the service brake is applied.

Press and hold the switch until the hopper is in the desired tilted position, then release the switch. An audio alarm will sound when the hopper is moving. The hopper tilt will automatically stop when it is fully tilted. The light next to the switch will come on while the hopper is being tilted. This light will flash when the switch is released and the hopper is in a tilted position.

⚠ WARNING: Lift arm pinch point. Stay clear of hopper lift arms.

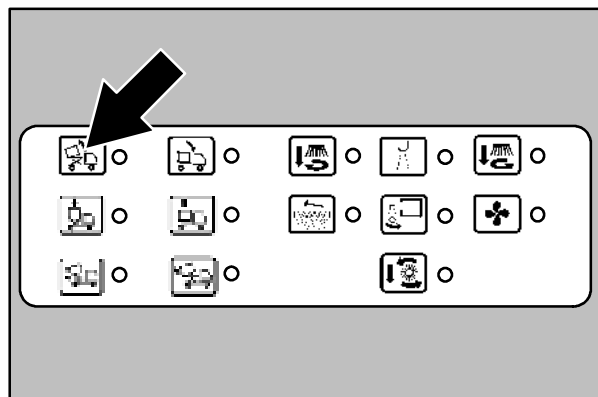

351926

HOPPER TILT FORWARD SWITCH

The *hopper tilt forward switch* tilts the hopper forward after dumping debris. Press and hold the switch until the hopper is fully forward. An audio alarm will sound when the hopper is moving. The light next to the switch will come on only while the switch is being pressed. The hopper is fully forward when the *hopper tilt back switch* light stops flashing.

NOTE: The hopper lift and tilt switches will not operate unless the parking brake is set or the service brake is applied.

⚠ WARNING: Lift arm pinch point. Stay clear of hopper lift arms.

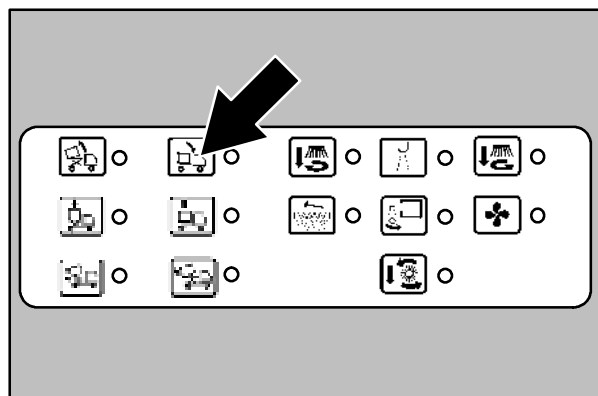

351926

OPERATION

HOPPER LIFT SWITCH (High Dump Model)

The *hopper lift switch* will raise the hopper for high dumping. It will also stop and raise the sweeping functions. The machine's travel speed is limited to 3 mph when the hopper is in the raised position.

NOTE: The hopper lift and tilt switches will not operate unless the parking brake is set or the service brake is applied.

NOTE: The minimum clearance height needed to high dump the hopper is 5060 mm (16.6 in).

 **WARNING: High dump vertical clearance. Stay clear of overhead obstructions and power lines.**

Press and hold the switch until the hopper is at the desired raised position, then release the switch. An audio alarm will sound when the hopper is moving. The hopper lift will automatically stop when it is fully raised. The light next to the switch will come on while the hopper is being raised. This light will flash when the switch is released with the hopper in a raised position.

NOTE: The hopper will not lift if the optional hopper incline or overload light is on. This indicates that the machine is either on an incline that is unsafe or that the hopper is too heavy for high dumping the hopper.

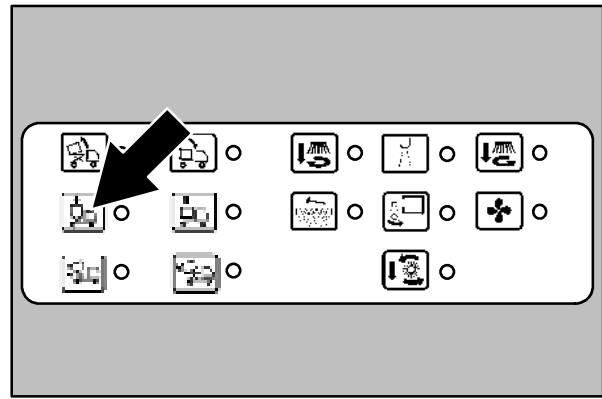

351926

HOPPER LOWER SWITCH (High Dump Model)

The *hopper lower switch* lowers the hopper after high dumping. Press and hold the switch until the hopper is fully lowered. An audio alarm will sound when the hopper is moving. The light next to the switch will come on only while the switch is being pressed. The hopper is fully lowered when the *hopper lift switch* light stops flashing.

NOTE: The hopper lift and tilt switches will not operate unless the parking brake is set or the service brake is applied.

 **WARNING: Lift arm pinch point. Stay clear of hopper lift arms.**

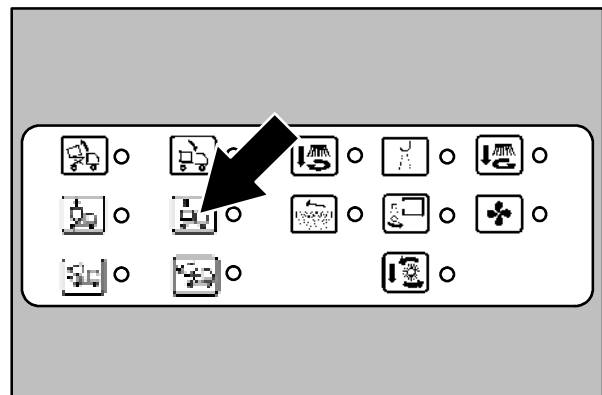

351926

HOPPER DOOR OPEN SWITCH

The *hopper door open switch* unlatches the hopper door. With the hopper tilted, press and hold the switch for 2–3 seconds. The hopper door will unlatch and open. The light next to the switch will flash when the hopper door is unlatched.

 **WARNING: Hopper door pinch point.**
Stay clear of hopper door.

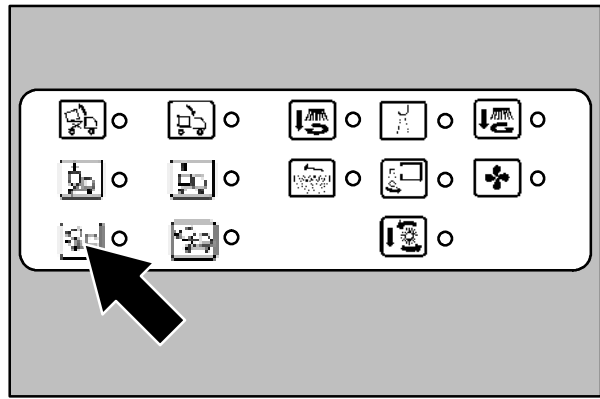

351926

HOPPER DOOR CLOSE SWITCH

The *hopper door close switch* latches the hopper door. With the hopper fully lowered, press and hold the switch for 2–3 seconds. The hopper must be fully lowered for the door to latch. The light next to the switch will come on only while the switch is being pressed. The door is latched when the *hopper door open switch* light stops flashing.

 **WARNING: Hopper door pinch point.**
Stay clear of hopper door.

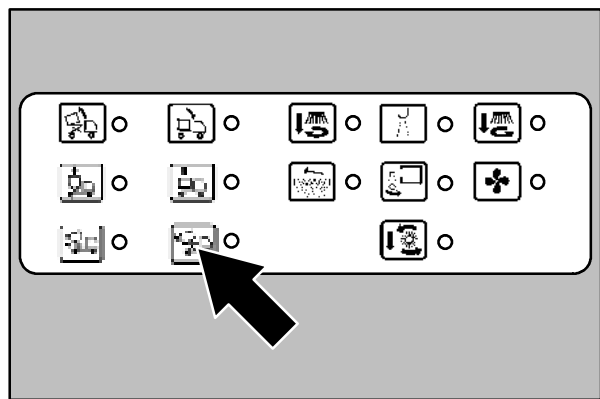

351926

WATER PUMP SWITCH (OPTION)

The *water pump switch* controls the water pump for the wet dust control system. Press the switch to activate the water pump. The light next to the switch will come on. To turn off the water pump, press the switch again. The light will turn off.

The water pump will shut off automatically when the *water tank low light* comes on.

NOTE: The water valve knobs must be turned open for the wet dust control system to work.

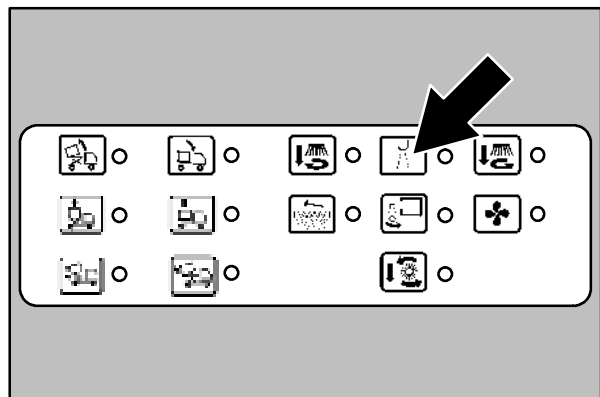

351926

OPERATION

LEFT SIDE BRUSH SWITCH (OPTION)

The *left side brush switch* controls the left side brush. Press the switch to lower and turn on the left side brush. The light next to the switch will come on. To lift and turn off the left side brush, press the switch again. The light will turn off.

NOTE: The side brushes will automatically turn on with the **SWEEP SWITCH** **IF** they were in the “on” position when the sweep switch was last turned off.

 **WARNING: Side brush can move. Do not step on side brush.**

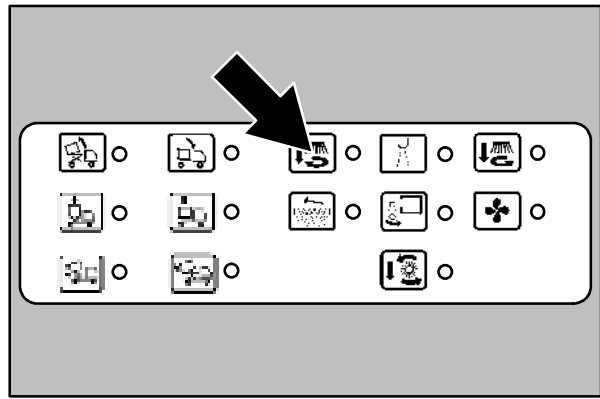

351926

RIGHT SIDE BRUSH SWITCH

The *right side brush switch* controls the right side brush. Press the switch to lower and turn on the right side brush. The light next to the switch will come on. To lift and turn off the right side brush, press the switch again. The light will turn off.

NOTE: The side brushes will automatically turn on with the **SWEEP SWITCH** **IF** they were in the “on” position when the sweep switch was last turned off.

 **WARNING: Side brush can move. Do not step on side brush.**

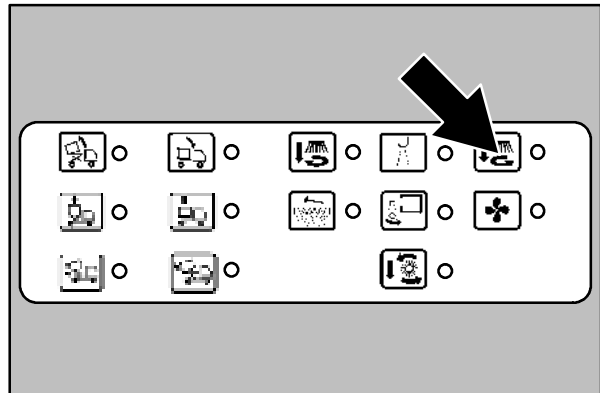

351926

FILTER SHAKER SWITCH

The *filter shaker switch* controls the hopper dust filter shaker system. It is used to shake clean the dust from the filter. With the throttle in the idle position, press and hold the switch for 1 to 2 seconds to activate the system. The light next to the switch will come on while the filter is shaking. The filter will shake for about 30 seconds, then it will stop and the light will turn off.

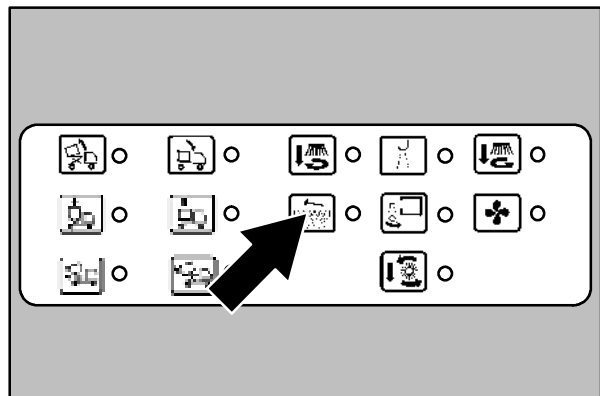

351926

CONVEYOR REVERSE SWITCH

The *conveyor reverse switch* controls the direction of the debris conveyor. The reverse direction is used for unjamming debris clogged in the conveyor and also for cleaning the conveyor. Press the switch to reverse the direction of the conveyor. The light next to the switch will come on. To return the conveyor to the forward sweeping direction, press the switch again. The light will turn off.

NOTE: Do NOT leave the conveyor reverse switch in the reverse position for sweeping.

 **WARNING: Conveyor throws debris. Conveyor pinch point. Stay clear when in operation.**

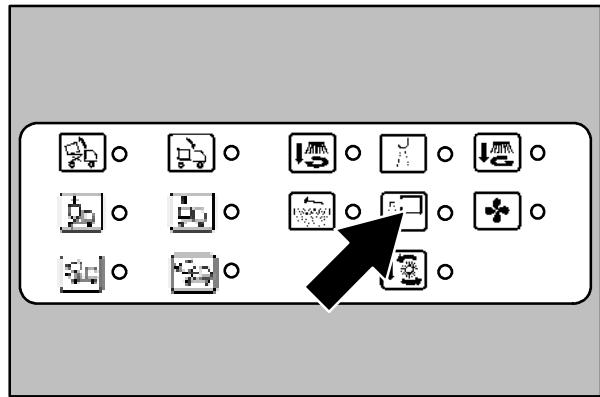

351926

VACUUM FAN SWITCH

The *vacuum fan switch* controls the vacuum fan. This switch will come on automatically when the *sweep switch* is activated. It can be controlled separately without the other sweeping functions. It can be turned on separately for operating the vacuum wand or it can be turned off separately while operating the machine in wet conditions. Press the switch to turn on the vacuum fan. The light next to the switch will come on. Press the switch again to turn the vacuum fan off. The light will turn off.

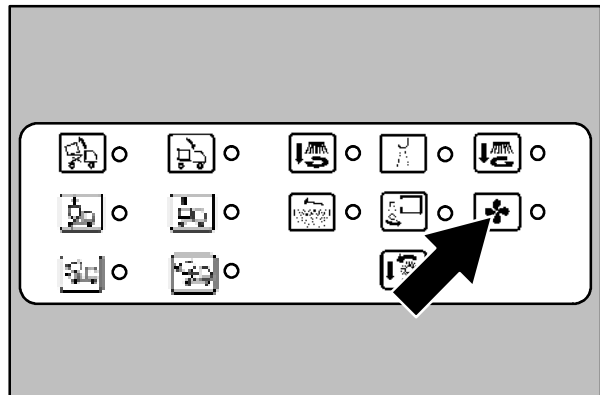

351926

OPERATION

SWEEP SWITCH

The *sweep switch* controls the sweeping functions of the machine. These functions include the vacuum fan, the main brush, the conveyor, and side brushes. They do **NOT** control the Vario brush.

NOTE: The sweep switch can NOT be activated if any of the hopper control switches are lit. The hopper must be in the fully forward and lowered position with the hopper door latched before sweeping.

To start the sweeping functions, press the *sweep switch*. The vacuum fan will come on, the main brush and conveyor will lower and will also come on. The lights next to these switches will come on. The side brushes will also automatically turn on with the *sweep switch* **IF** they were in the *on* position when the sweep switch was last turned off.

NOTE: If the engine speed is operating too fast for sweeping, the sweeping functions will lift and turn off after 15 seconds. See the TACHOMETER section of this manual.

To stop and raise the sweeping functions, press the *sweep switch* again. The lights next to these sweeping function switches will turn off.

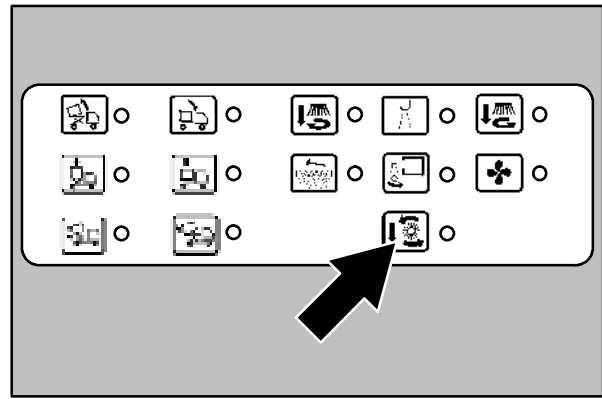

351926

4-WAY WARNING LIGHTS SWITCH

The *4-way warning lights switch* powers on and off the warning lights.

On: Press the top of the 4-way warning lights switch. The light will come on.

Off: Press the bottom of the 4-way warning lights switch. The light will go off.

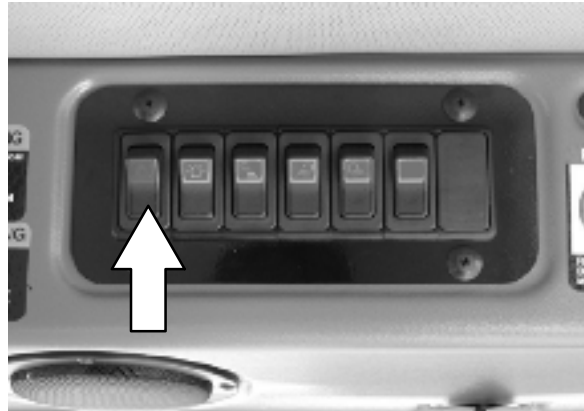
**HAZARD LIGHT SWITCH**

The *hazard light switch* powers on and off the hazard light.

On: Press the top of the hazard light switch. The light will come on.

Off: Press the bottom of the hazard light switch. The light will go off.

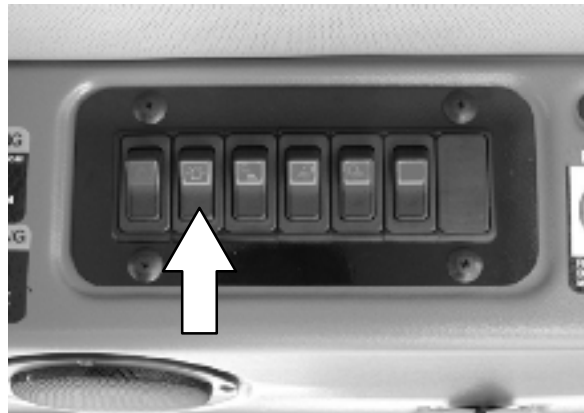
**SIDE BRUSH SPOT LIGHT(S) SWITCH**

The *side brush spot light(s) switch* powers on and off the side brush spot light(s).

On: Press the top of the side brush spot light(s) switch. The light(s) will come on.

Off: Press the bottom of the side brush spot light(s) switch. The light(s) will go off.

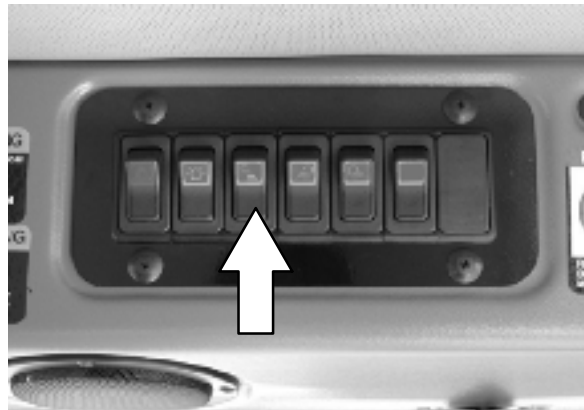

OPERATION

REAR NIGHT SWEEPING LIGHT SWITCH (OPTION)

The *rear night sweeping light switch* powers on and off the rear sweeping light.

On: Press the top of the rear night sweeping light switch. The light will come on.

Off: Press the bottom of the rear night sweeping light switch. The light will go off.

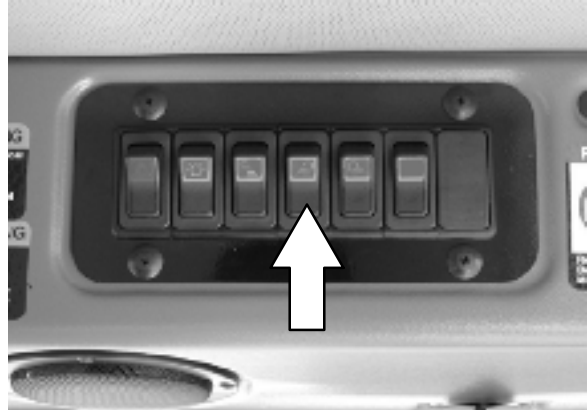

FRONT NIGHT SWEEPING LIGHT SWITCH (OPTION)

The *front night sweeping light switch* powers on and off the front sweeping light.

On: Press the top of the front night sweeping light switch. The light will come on.

Off: Press the bottom of the front night sweeping light switch. The light will go off.

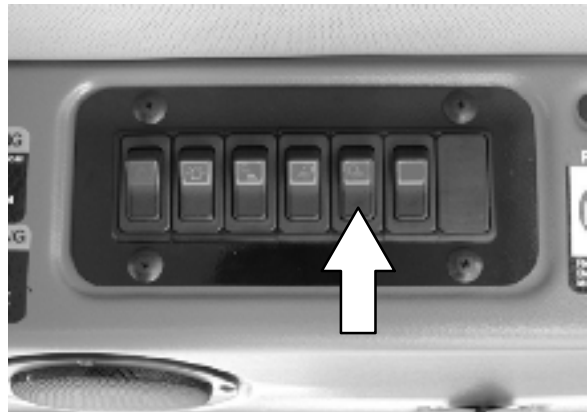

HIGH PRESSURE WASHER SWITCH (OPTION)

The *high pressure washer switch* powers on and off the high pressure washer.

On: Press the top of the high pressure washer switch. The light will come on.

NOTE: The high pressure washer option will not operate unless the parking brake is set.

Off: Press the bottom of the high pressure washer switch. The light will go off.

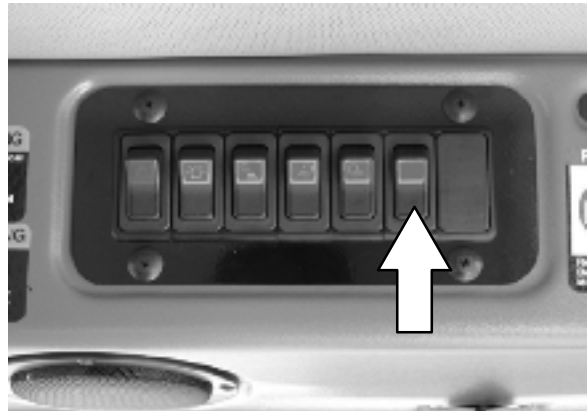

FOR SAFETY: When using pressurized air or water, wear eye and ear protection.

DOME AND MAP LIGHT SWITCH

The *dome and map light switch* controls the dome and map light on the ceiling of the cab.

Map Light On: Push the switch toward the passenger side of the cab.

Dome and Map Light On: Pull the switch toward the operator side of the cab.

Off: Place the switch to the middle position.

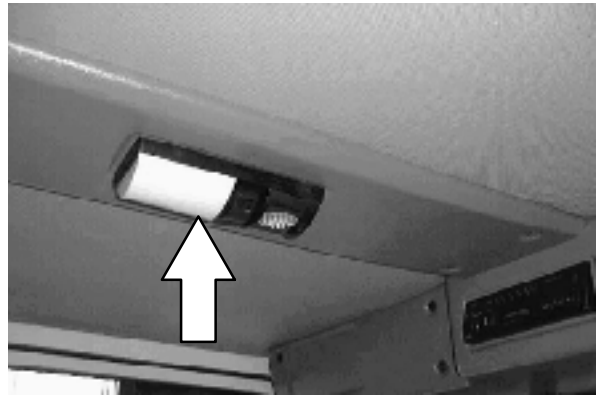
**RADIO AND COMPACT DISK PLAYER (OPTION)**

The *radio and compact disk player* is located above the operator. Refer to the radio/compact disk player's manual for operation.

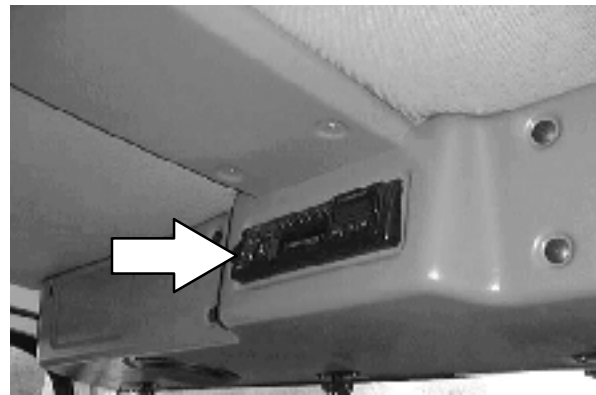
**LATCHES**

The cab doors, side doors, and main brush access doors are secured with latches.

Open the Cab Doors: Pull out on the latch handle and turn the latch handle 90°.

Open the Side Doors: Push in the button and pull on the latch handle.

Open the Main Brush Access Doors: Pull on the rubber latch until the door is loose. Remove the door by pulling the door from the pins in the machine frame.



OPERATION

TRAFFIC ADVISOR SIGNAL LIGHT SWITCH (OPTION)

The *traffic advisor signal light switch* controls the traffic advisor signal light on the back of the machine.

Lights On (High): Press the top of the switch.

Lights On (Low): Press the bottom of the switch.

Off: Press the switch to the middle position.



TRAFFIC ADVISOR SIGNAL LIGHT FUNCTION KNOB (OPTION)

The *traffic advisor signal light function knob* allows the machine operator to choose between the four different signal light patterns.

Use the *traffic advisor signal light function knob* to select between the LEFT, RIGHT, SPLIT and FLASH patterns.

The light strip in the lower right hand corner of the controller mirrors the light pattern that is being displayed on the traffic advisor signal light on the back of the machine.

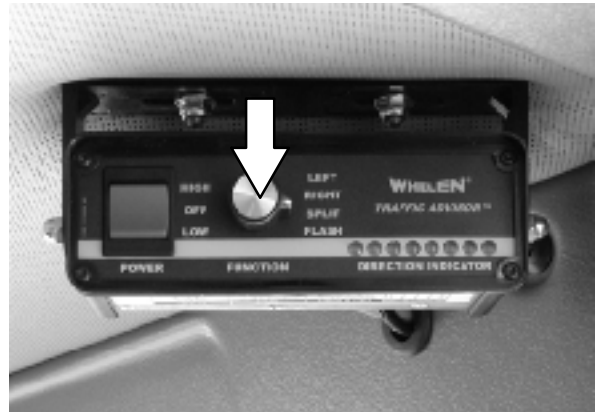

HOPPER SUPPORT PIN

The hopper support pin holds the hopper in the tilt back position to allow work under the hopper. DO NOT rely on the machine hydraulic system to keep the hopper raised. See *ENGAGING HOPPER SUPPORT PIN* section of this manual.

 **WARNING: Raised hopper may fall.**
Engage hopper support pin.

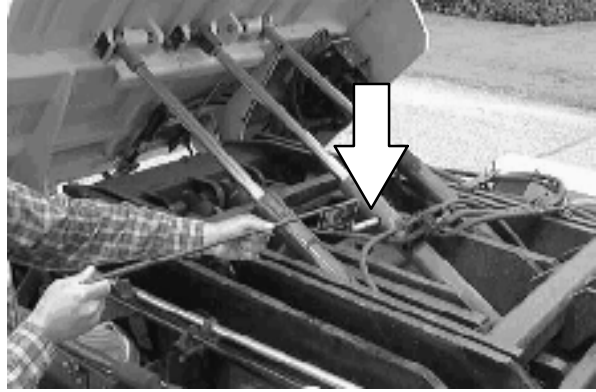

The hopper support pin is stored on the right rear fender under the hopper.

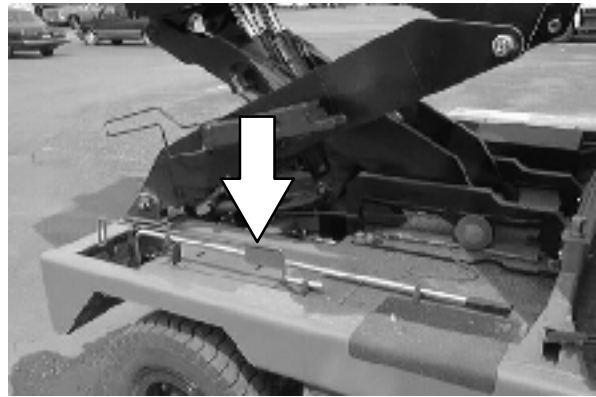

OPERATION

HOPPER SUPPORT BAR (High Dump Model)

The hopper support bar holds the hopper in the raised position to allow work under the hopper. DO NOT rely on the machine hydraulic system to keep the hopper raised. See *ENGAGING HOPPER SUPPORT BAR* section of this manual.

 **WARNING:** Raised hopper may fall. Engage hopper support bar.

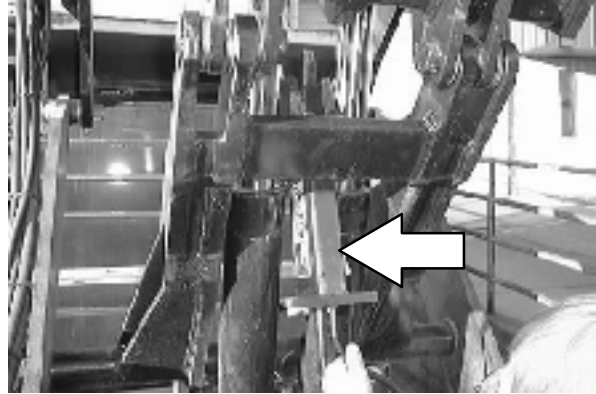

The hopper support bar is stored on the right side of the lift arms.

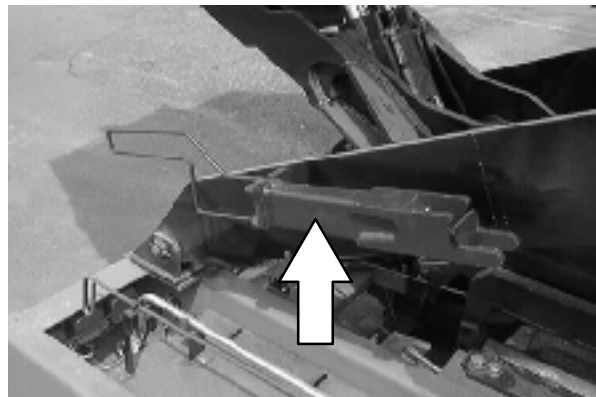

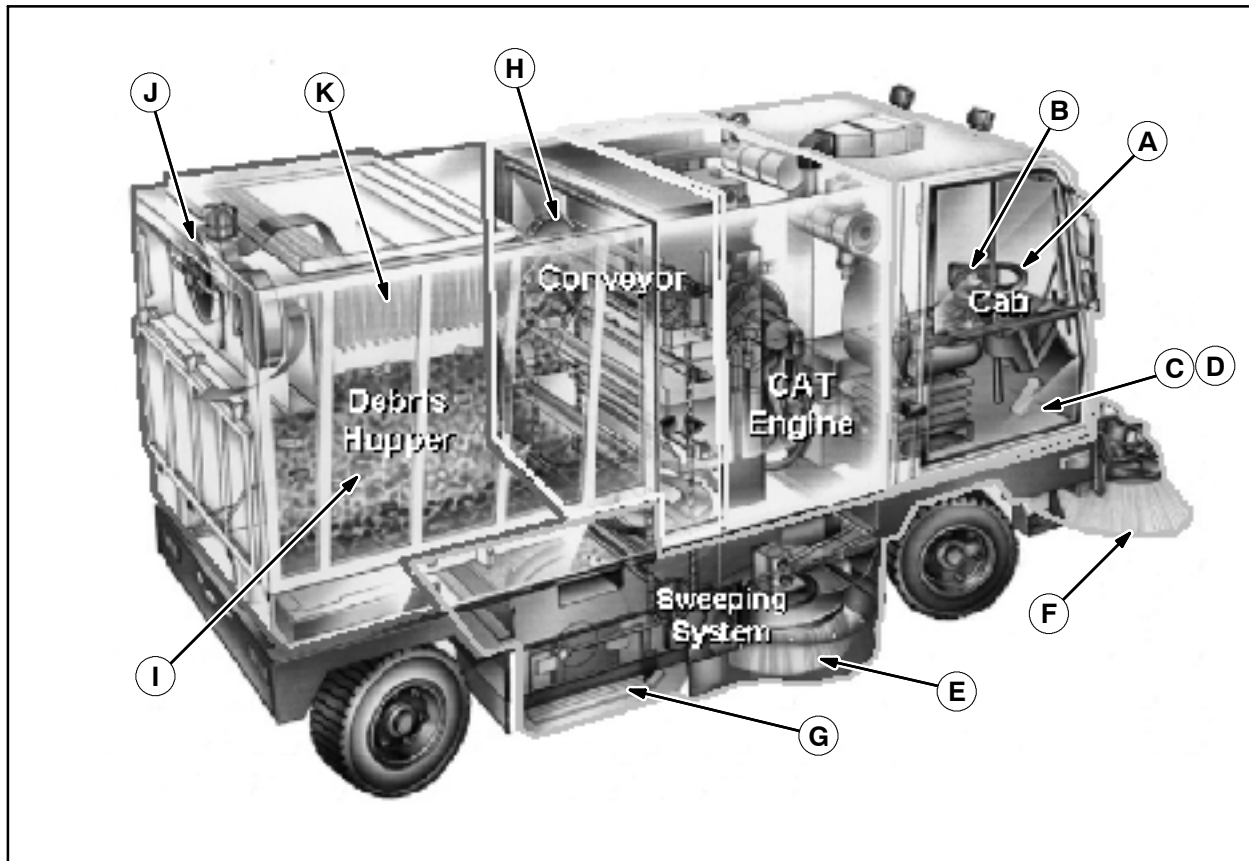

HOW THE MACHINE WORKS

The steering wheel **(A)** controls the direction of machine travel. The directional lever **(B)** controls the forward/reverse direction. The propelling pedal **(C)** controls machine speed. The brake pedal **(D)** slows and stops the machine.

The side brush **(E)** and vario brush (option) **(F)** sweep debris into the path of the main brush **(G)**. The main brush **(G)** sweeps debris from the surface onto the conveyer **(H)**, which transfers the debris into the hopper **(I)**. The vacuum system **(J)** pulls dust and air through the hopper **(I)** and the hopper dust filter **(K)**.

The machine has a right side brush **(E)**, an optional Vario Sweeping Brush™ **(F)**, and an optional left side brush. There is also either a wet or dry dust control system.

When sweeping is finished, clean the hopper dust filter **(K)** and empty the hopper **(I)**.

PRE-OPERATION CHECKLIST

- Check the engine oil level.
- Check the engine coolant level.
- Check the windshield washer fluid level.
- Check the radiator and hydraulic cooler fins for debris.
- Check the hydraulic fluid level.
- Check the air filter indicator.
- Check the skirts and seals for damage and wear.
- Check the condition of the sweeping brushes. Remove any string, banding, plastic wrap, or other debris wrapped around them.
- Check the sweeping brush patterns for adjustment.
- Check the condition of the hopper dust filter and seals. Clean as required.
- Check the brakes and steering for proper operation.
- Check the fuel level.
- Empty the debris hopper.
- Check the service records to determine maintenance requirements.

STARTING THE MACHINE

1. Check the *directional lever* to make sure it is in the middle neutral position.

NOTE: Machine will not start unless the directional lever is in the neutral position.

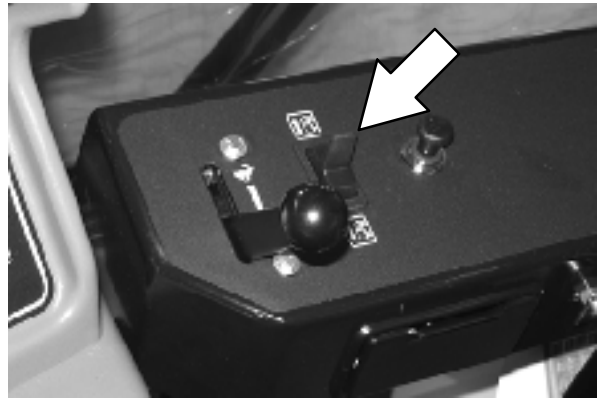

2. Sit in the operator's seat and fasten the seat belt. Place your foot on the *brake pedal* or set the parking brake.

NOTE: The machine will not propel unless the operator is in the seat.

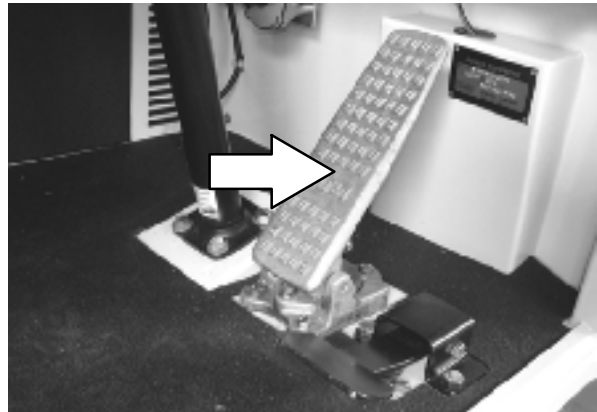

3. Move the *throttle lever* back to the idle position.

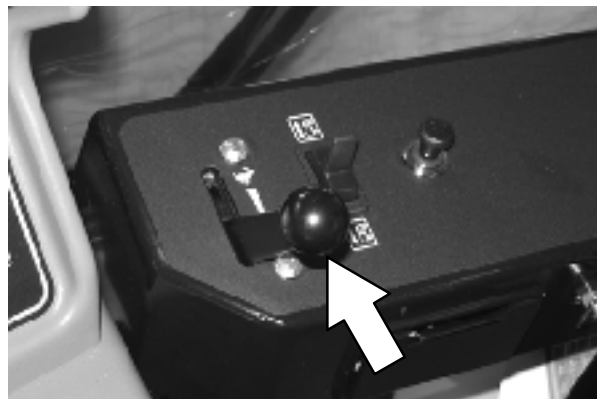

OPERATION

4. Turn the key counter-clockwise. The glow plugs light will come on. When the glow plug light goes out, usually for 5 to 30 seconds depending on the weather conditions, the engine is ready to start.

NOTE: The preheat is not necessary if the temperature is above 10° C (50° F).

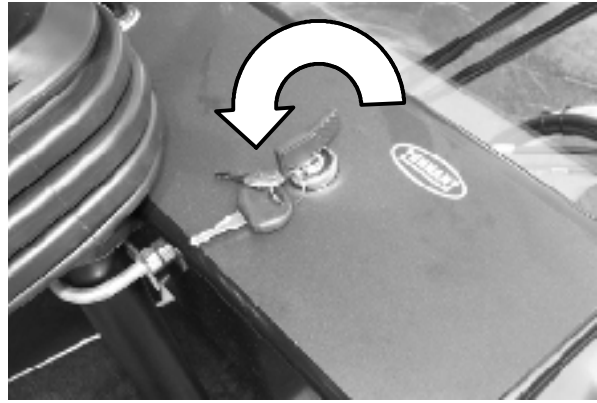

5. Turn the ignition switch key clockwise until the engine starts.

NOTE: Do not operate the starter motor for more than 10 seconds at a time or after the engine has started. Allow the starter to cool between starting attempt or damage to the starter motor may occur.

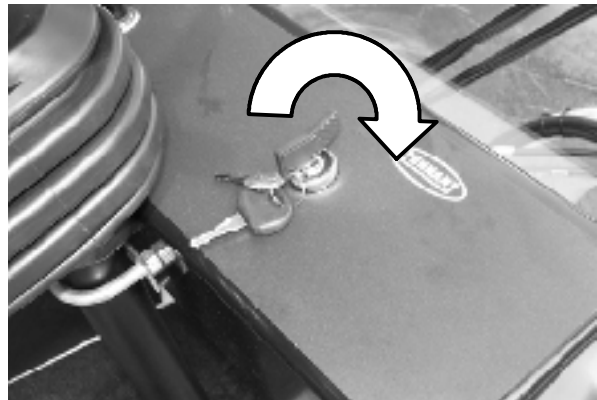

6. Turbo Charged Engines: Allow the engine to operate for at least 30 seconds at low idle before adjusting the throttle lever.
7. Allow the engine and hydraulic system to warm up three to five minutes.

⚠ WARNING: Engine emits toxic gases. Severe respiratory damage or asphyxiation can result. Provide adequate ventilation. Consult with your regulatory agency for exposure limits. Keep engine properly tuned.

8. Adjust the *throttle lever* to the desired engine speed.

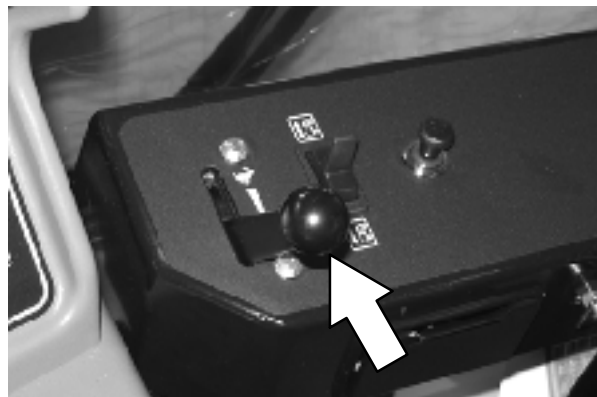

9. Press the bottom of the *parking brake switch* to release the parking brake.

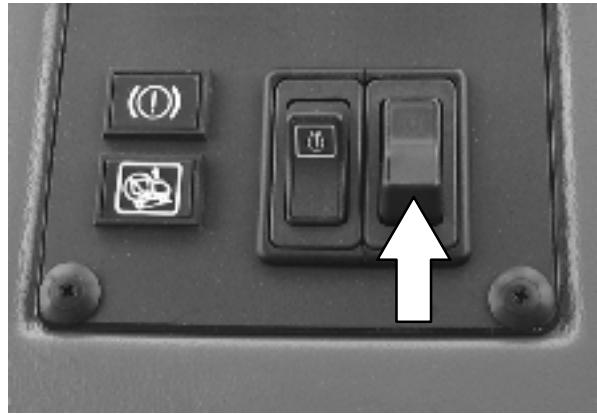

10. Place the *directional lever* in the **Forward** position.

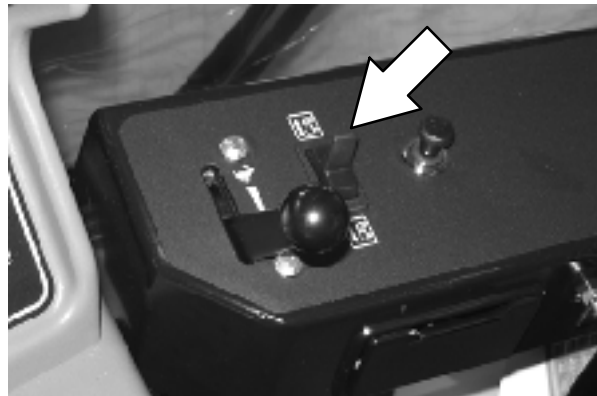

11. Release the brake pedal and press on the propelling pedal to transport the machine. The more foot pressure, the faster the machine will travel.

NOTE: The machine will not propel unless the operator is in the seat and the parking brake is released.

12. Drive the machine to the area to be swept. When transporting to the sweeping area and equipped with the *Vario Sweeping Brush™*, lock the brush into the travel support with the guide pin.

FOR SAFETY: When using machine, always follow safety and traffic rules.

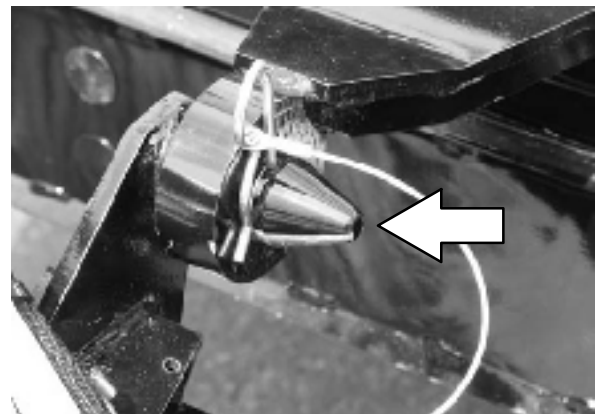

SWEEPING AND BRUSH INFORMATION

The model Sentinel has a GVWR of 9072 kg (20,000 lb) or 4536 kg (10,000 lb) per axle. Operate only on surfaces capable of supporting this weight.

Avoid bulky debris such as crates, boxes, tree branches, and very heavy material. Avoid pieces of straps, twine, rope, etc., which could become entangled in brush, brush plugs or the conveyor.

Plan the sweeping in advance. Try to arrange long runs with minimum stopping and starting. Sweep as straight a path as possible. Overlap the brush paths.

Avoid turning the steering wheel too sharply when the machine is in motion. The machine is very responsive to the movement of the steering wheel. Avoid sudden turns, except in emergencies.

Use the wet dust control option in dusty conditions. With wet roads, do not use the wet dust control option.

For best results, use the correct brush type for your sweeping application. The main sweeping brush is a polypropylene brush. The following are recommendations for side brush and *Vario Sweeping Brush*™.

Polypropylene and Wire Side Brush -

Recommended for general purpose sweeping. Best combination of sweeping and aggressiveness.

Flat Wire Side Brush - Recommended for outside and curb-side sweeping where soilage is heavy or compacted. The stiff wire bristles dig out soilage. This brush does not sweep as good as the *Polypropylene and Wire Side Brush* but is recommended for foundry sweeping where heat may melt synthetic bristles.

Polypropylene Side Brush - Recommended for sweeping where you cannot have wire fragments. This brush does not sweep as good as the *Polypropylene and Wire Side Brush* but is recommended for areas such as airports.

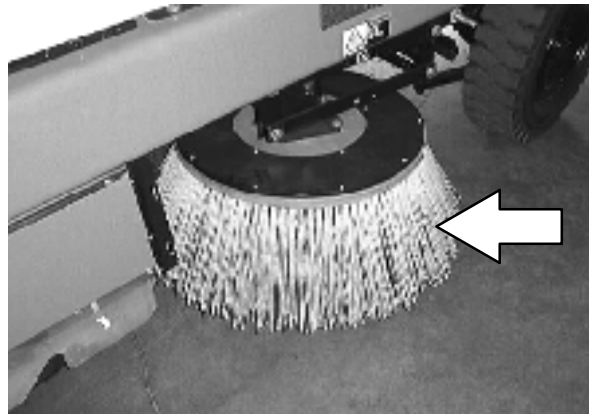

SWEEPING

1. Check the switch panel to make sure that all the hopper control lights are off. The hopper must be in a fully lowered and forward position with the hopper door closed before sweeping.

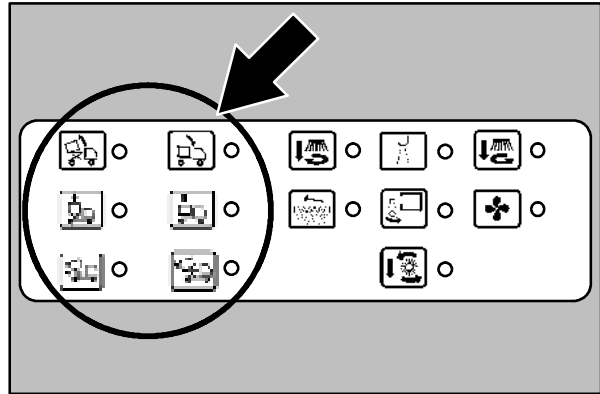

351926

2. Check the switch panel to make sure that the *conveyor reverse switch* is NOT lit. When the light is NOT on, this indicates that the conveyor is in the forward sweeping direction.

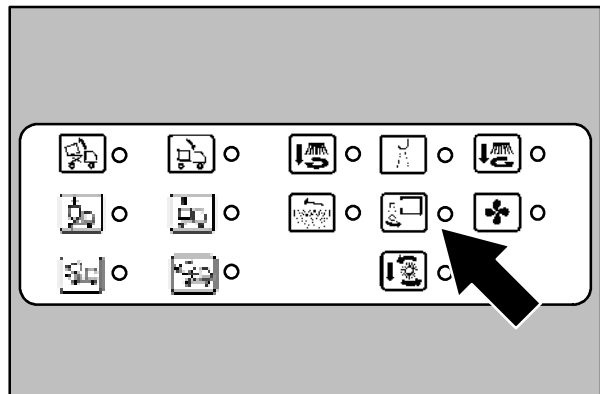

351926

3. When sweeping light litter (leaves or light trash) check that the conveyor stop brackets are flipped back in position on both sides of the machine.

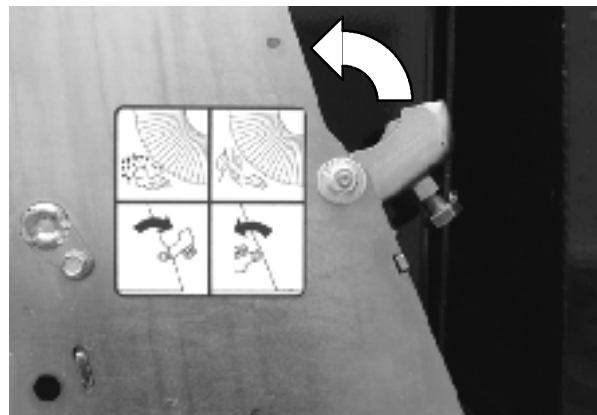

OPERATION

- Adjust and start the *Vario Sweeping Brush* if equipped. Refer to the *Vario Sweeping Brush* section of this manual.

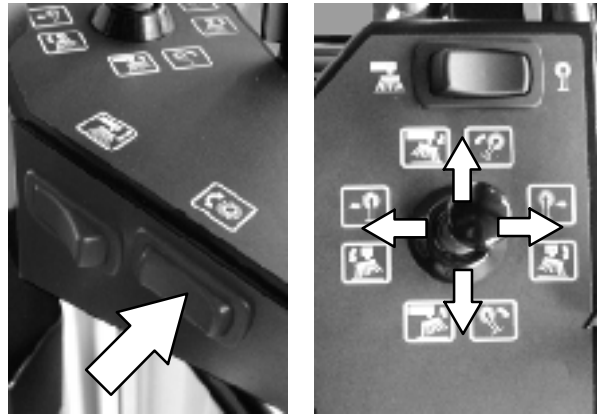

- Move the *throttle lever* till the tachometer shows the desired engine RPM for the type of sweeping you are doing. Refer to the following chart.

Debris	Engine RPM	Travel Speed
General Debris	1600-1800 RPM	(5-13 kmh) 3-5 mph
Fine Dust	1500-1800 RPM	(5-13 kmh) 3-5 mph
Light Debris (Leaves, grass) (Shake filter often)	1800-2000 RPM	(5-13 kmh) 3-5 mph
Wet Sweeping (Vacuum fan on)	1800-2000 RPM	(5-13 kmh) 3-5 mph
Heavy Debris	1800-2000 RPM	Slower than 5 kph (3 mph)
Vacuum Wand (Ear plugs mandatory)	2300-2400 RPM	None

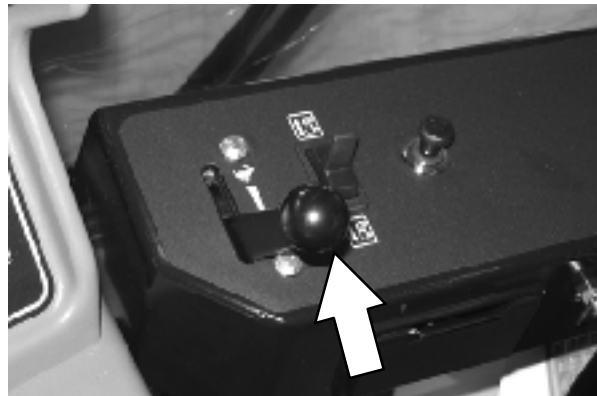

NOTE: Do NOT sweep with engine speed higher than 2000 RPM. If the engine speed is operating above 2000 RPM, the green SWEEP light will blink and an audio alarm will sound. This will continue for 15 seconds, then the main sweeping functions will lift and turn off.

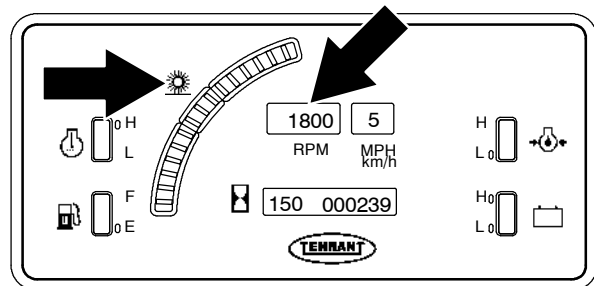

351927

6. Press the *sweep switch*. This will lower and start the sweeping functions. The lights next to these switches will come on.

*NOTE: The side brushes will automatically turn on with the SWEEP SWITCH **IF** they were in the **on** position when the sweep switch was last turned off.*

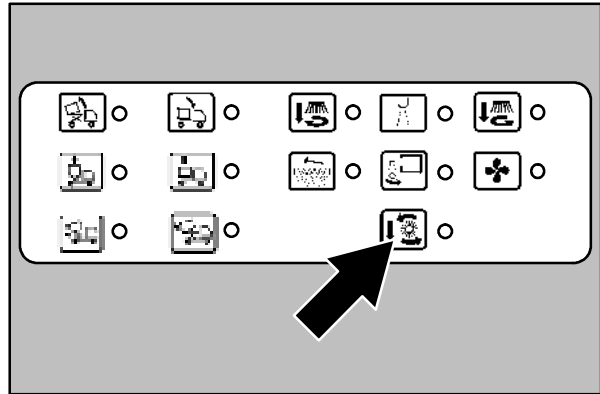

7. Start the *wet dust control system* if equipped. Refer to the *wet dust control system* section of this manual.

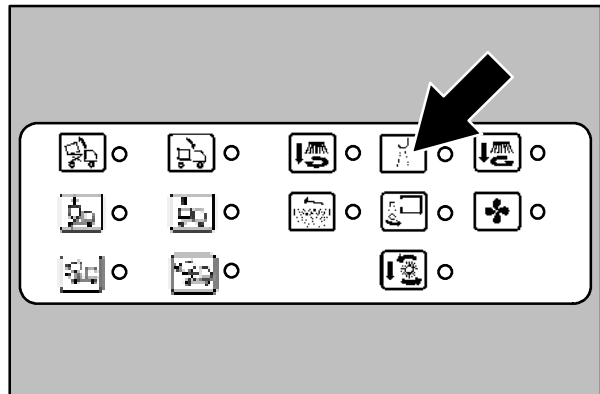

8. Press the *side brush switch(es)*. This will lower and start the side brush(es). The light(s) next to the switch(es) will come on.

*NOTE: The side brushes will automatically turn on with the SWEEP SWITCH **IF** they were in the **on** position when the sweep switch was last turned off.*

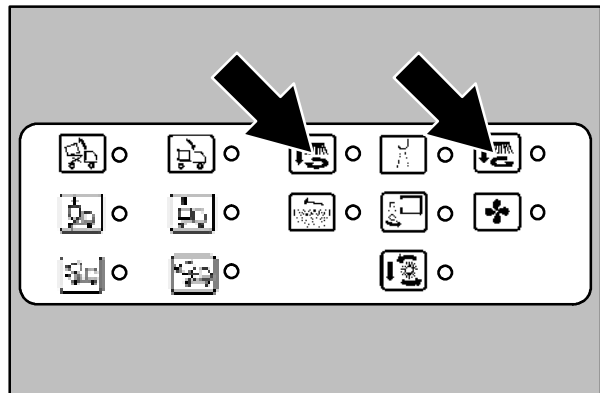

OPERATION

9. Press the bottom of the *parking brake switch* to release the parking brake.

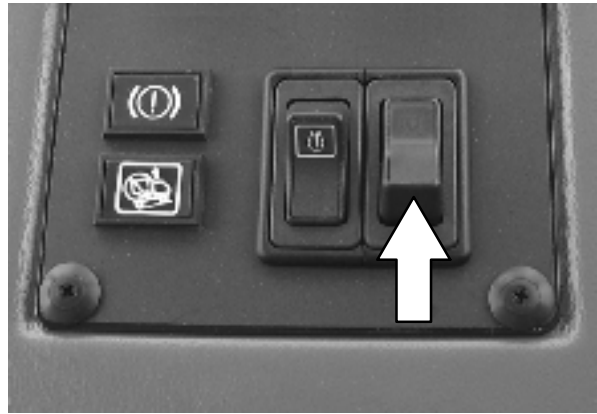

10. Press the *propelling pedal* and start sweeping.

NOTE: In dusty conditions, periodically place the engine throttle in the idle position and shake clean the hopper dust filter.

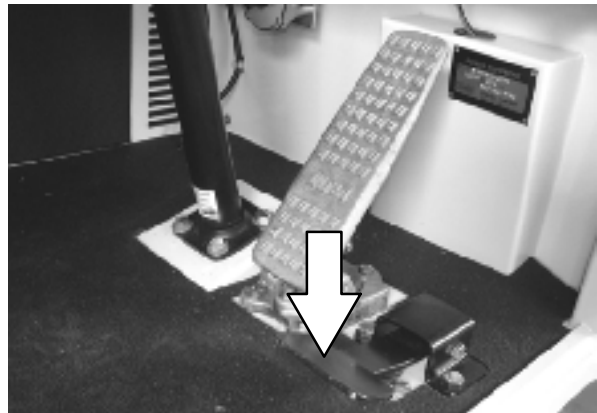

11. Stop sweeping if the conveyor overload alarm sounds. This alarm means that either a large object is jammed in the conveyor, that there is too much heavy debris in the conveyor, or that the hopper opening is filled.

If a large object is jammed in the conveyor, the alarm will sound constantly even *after* the machine is stopped. To clear the jammed object, stop sweeping, reduce the engine speed, and place the debris lift direction switch in the reverse position until the debris is removed. Then place the switch back in the forward position and continue sweeping.

If there is too much heavy debris in the conveyor, the alarm will sound constantly *until* the machine has stopped. This means that the debris must be swept at a slower travel speed.

If the hopper opening is filled, the alarm will *chirp* intermittently. The opening can be cleared by redistributing the debris in the hopper. To do this, stop sweeping and tilt the hopper back. Then return the hopper to the sweeping position and continue to sweep.

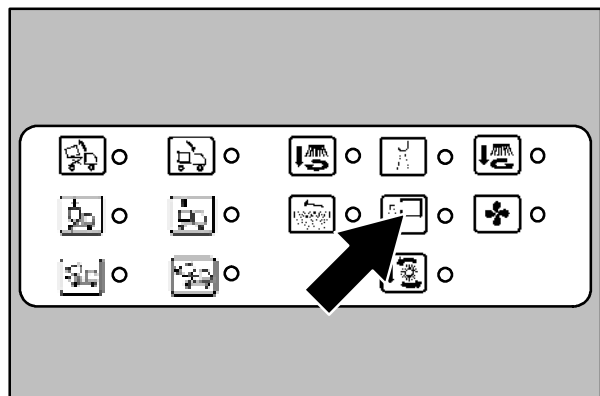

351926

STOP SWEEPING

1. Press the *sweep switch*. This will raise and stop the sweeping functions. The lights next to these sweeping function switches will turn off.

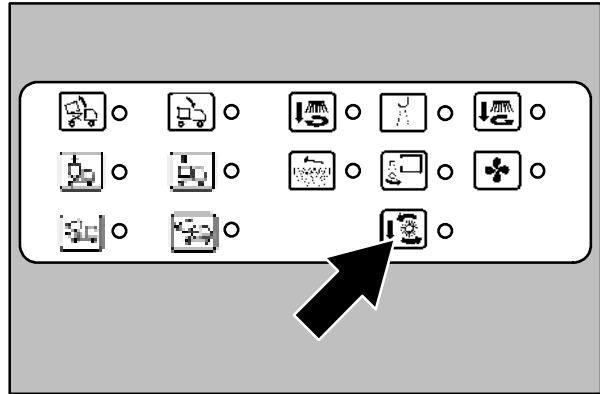

351926

2. Stop the *wet dust control system* if equipped. Refer to the *wet dust control system* section of this manual.

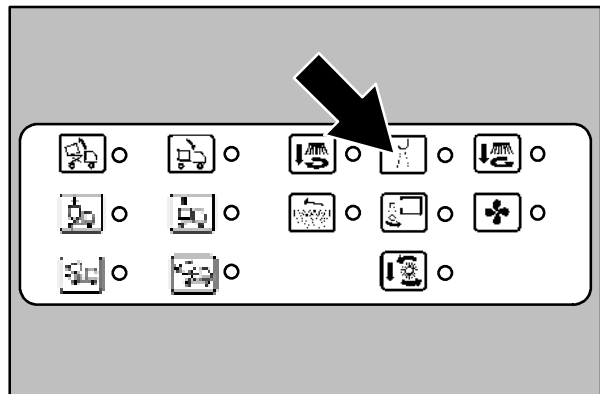

351926

3. Check to make sure all the sweeping function lights are out. If any lights are lit, press the switch to turn it off.

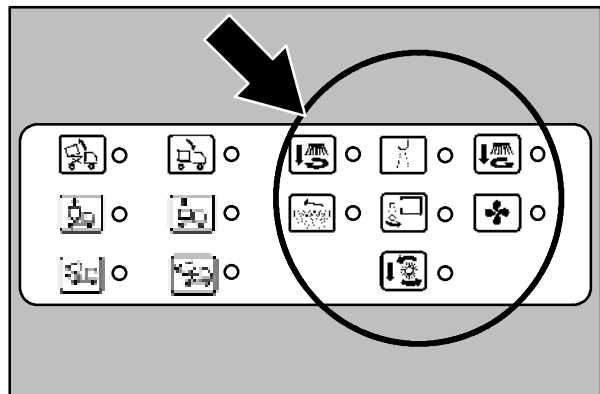

351926

OPERATION

4. Stop the *Vario Sweeping Brush* if equipped. Refer to the *Vario Sweeping Brush* section of this manual.

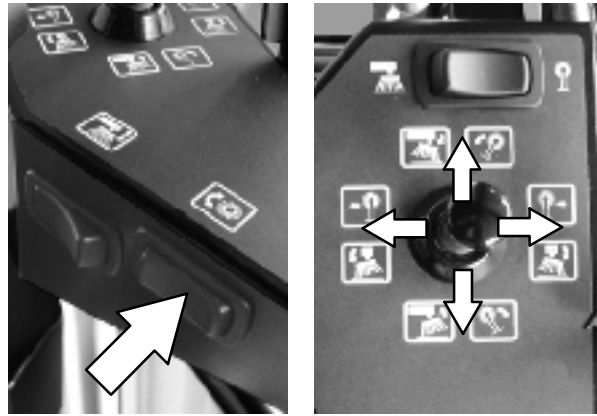

5. Place the *engine throttle* in the idle position and press the *filter shaker switch* to clean the hopper filter. The filter will shake for about 30 seconds. The light next to the switch will come on while the filter is shaking, then turn off.

NOTE: Shake the dust filter **before** tilting the hopper.

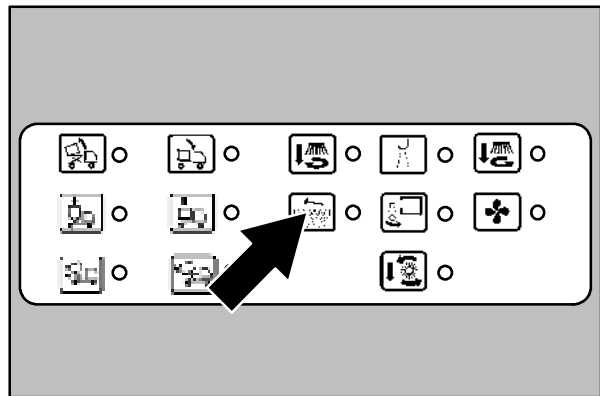

351926

EMPTYING THE HOPPER

1. Drive the machine slowly to the debris collection site or debris container. Make sure the machine is on level ground before dumping the hopper.

FOR SAFETY: Only dump the hopper on a level surface.

2. Press and hold the brake pedal with your foot, then push the throttle lever forward to increase the engine speed.

NOTE: The hopper will not lift or tilt unless the parking brake is set or the service brake is applied.

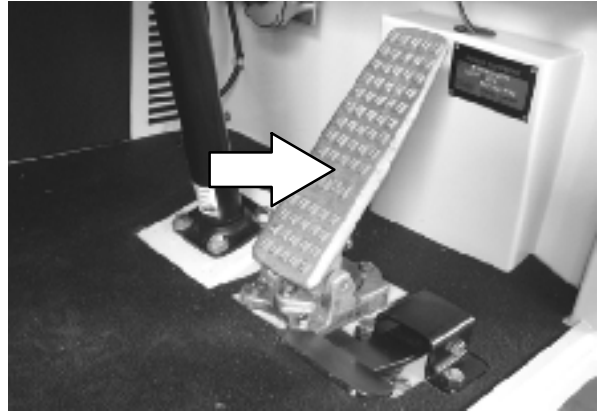

3. For High Dump Model: Press and hold the *hopper lift switch* until the hopper is at the desired raised position, then release the switch. An audio alarm will sound when the hopper is moving.

NOTE: The hopper will not lift if the optional hopper incline or overload light is on. This indicates that the machine is either on an incline that is unsafe or that the hopper is too heavy for high dumping the hopper.

NOTE: The minimum clearance height needed to high dump the hopper is 5060 mm (16.6 in).

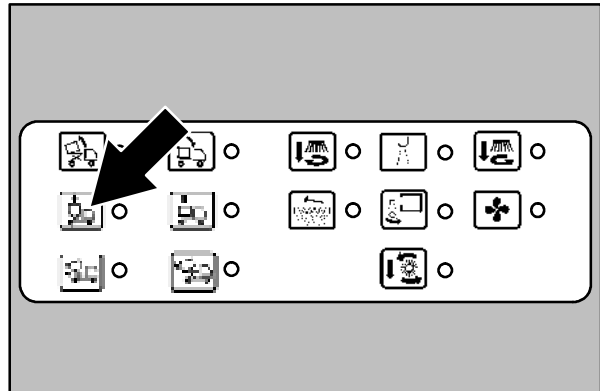

351926

⚠ WARNING: High dump vertical clearance. Stay clear of overhead obstructions and power lines.

OPERATION

- Place the *directional lever* in the *reverse* position, release the brake and slowly back the machine up to the debris site or container.

FOR SAFETY: Move machine with care when hopper is raised.

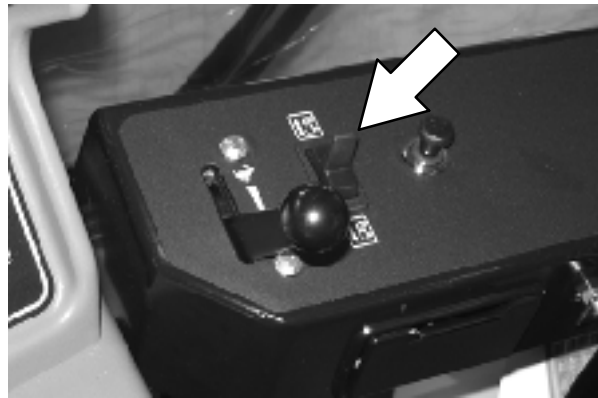

- Press and hold the brake pedal with your foot.

NOTE: The hopper will not lift or tilt unless the parking brake is set or the service brake is applied.

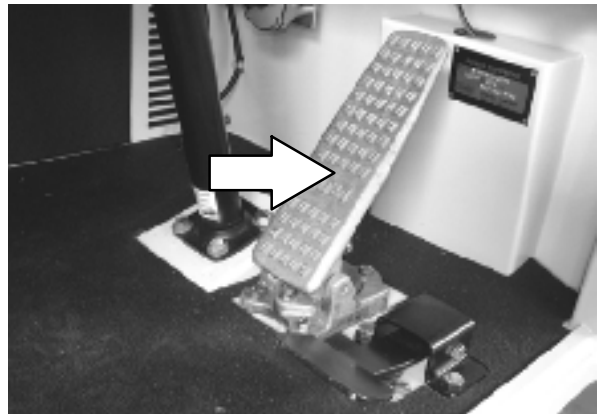

- Press and hold the *hopper tilt back switch* until the hopper is in the desired tilted position, then release the switch. An audio alarm will sound when the hopper is moving.

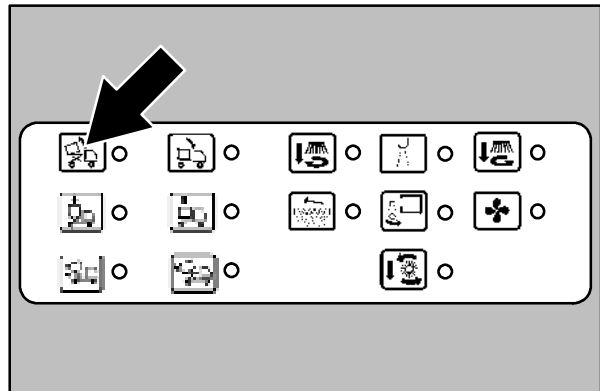

351926

7. Press and hold the *hopper door open switch* for 2-3 seconds. The hopper door will open and the debris will fall out.

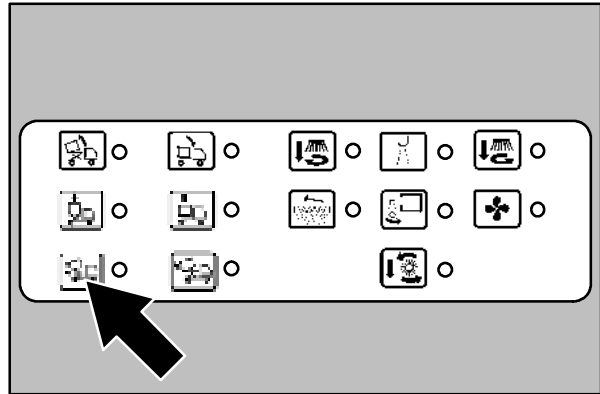

351926

8. Place the *directional lever* in the *forward* position, release the brake and slowly drive the machine away from the debris site or container.

FOR SAFETY: Move machine with care when hopper is raised.

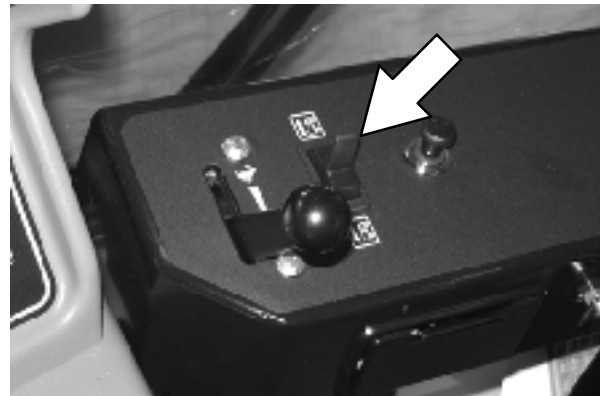

9. Press and hold the brake pedal with your foot.

NOTE: The hopper will not lift or tilt unless the parking brake is set or the service brake is applied.



OPERATION

10. Press and hold the *hopper tilt forward switch* until the hopper is fully forward, then release the switch. An audio alarm will sound when the hopper is moving.

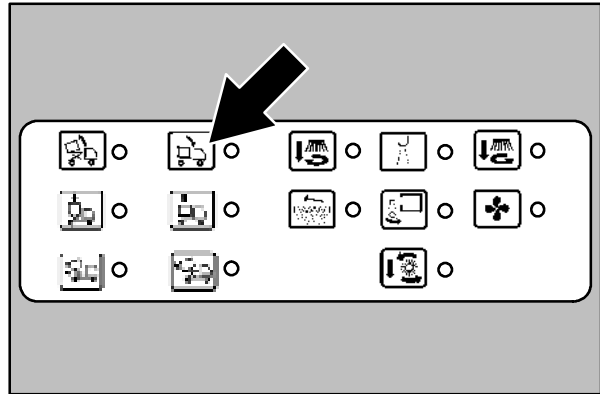

351926

11. Press and hold the *hopper door close switch* for 2-3 seconds. The hopper door will latch in the closed position.

 **WARNING: Hopper door pinch point.**
Stay clear of hopper door.

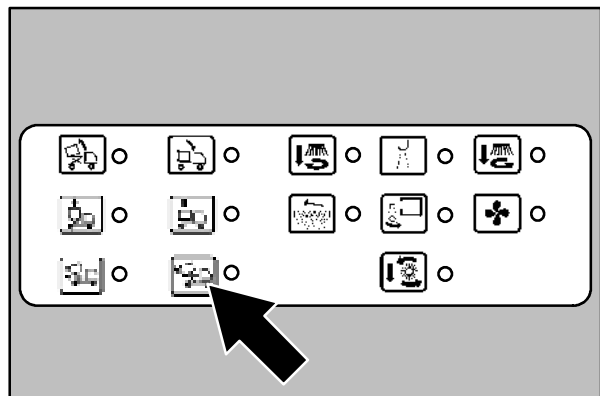

351926

12. For High Dump Model: Press and hold the *hopper lower switch* until the hopper is fully lowered, then release the switch. An audio alarm will sound when the hopper is moving.

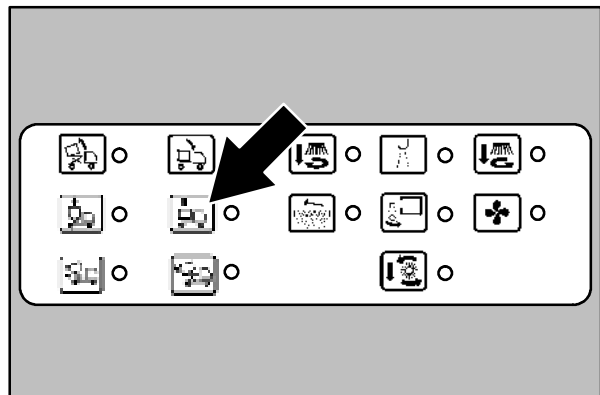

351926

13. Check the switch panel to make sure that all the hopper control lights are off. The hopper must be in a fully lowered and forward position with the hopper door closed before sweeping again.

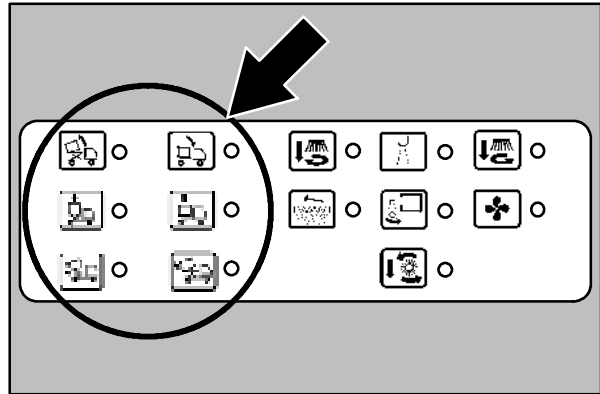

351926

STOP THE MACHINE

1. Stop sweeping. Refer to the *STOP SWEEPING* section of this manual.
2. Take your foot off the propelling pedal. Step on the brake pedal.

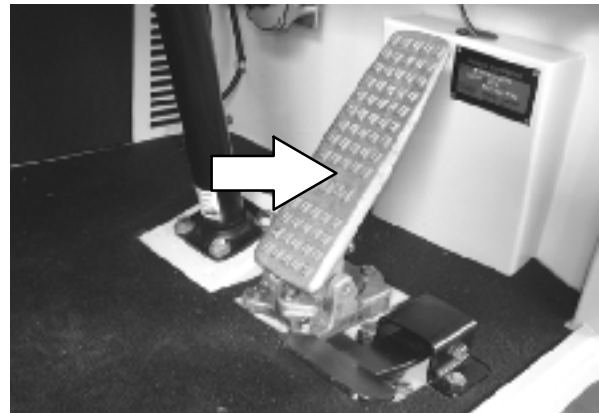

3. Move the *throttle lever* back to the idle position.
4. Turbo Charged Engines: Allow the engine to operate for at least 30 seconds at low idle before shutting the engine off.

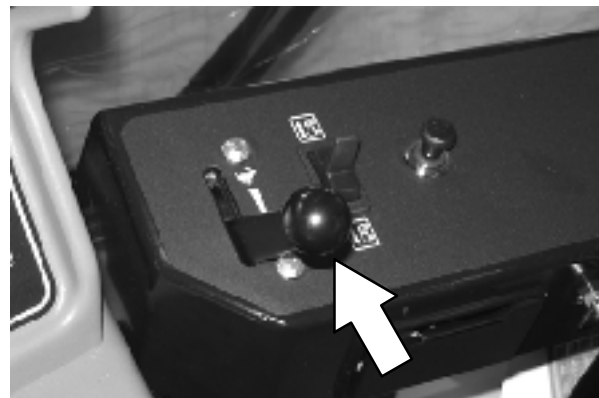

OPERATION

5. Press on the top part of the *parking brake switch* to set the parking brake.

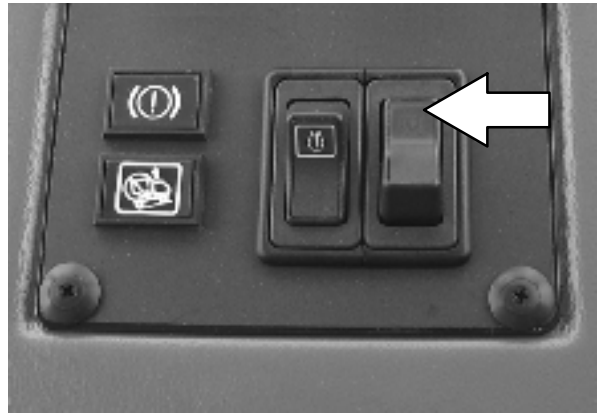

6. Turn the ignition switch key counter-clockwise to stop the engine. Remove the switch key.

FOR SAFETY: Before leaving or servicing machine, stop on level surface, set parking brake, turn off machine and remove key.

7. Turn off all accessories such as lights, water valves, and the cab fan. Even with the machine off, many of these accessories will continue to operate unless turned off.

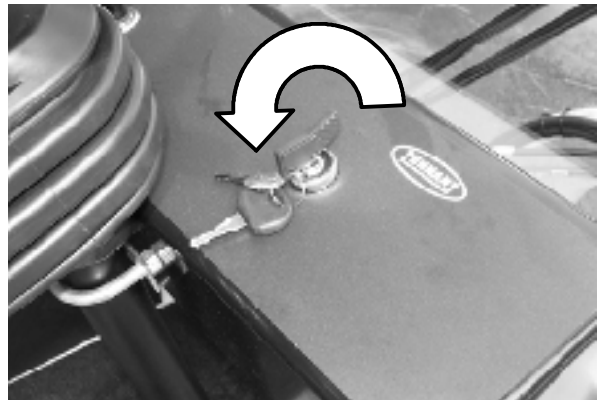

POST-OPERATION CHECKLIST

- Check the engine oil level.
- Check the engine coolant level.
- Check the radiator and hydraulic cooler fins for debris.
- Check the hydraulic fluid level
- Check the air filter indicator.
- Check the skirts and seals for damage and wear.
- Check the condition of the sweeping brushes. Remove any string, banding, plastic wrap, or other debris wrapped around them.
- Check the sweeping brush patterns for adjustment.
- Check the condition of the hopper dust filter and seals. Clean as required.
- Lubricate the conveyor chain.
- Check the brakes and steering for proper operation.
- Check the fuel level
- Empty the debris hopper.
- Check the service records to determine maintenance requirements.

ENGAGING HOPPER SUPPORT PIN

1. Press on the top part of the *parking brake switch* to set the parking brake.

FOR SAFETY: Before leaving or servicing machine, stop on level surface, set parking brake, turn off machine and remove key.

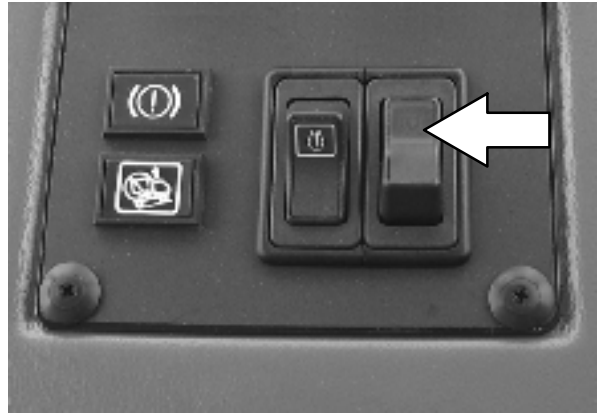

2. Start the engine and push the throttle lever forward to increase the engine speed.

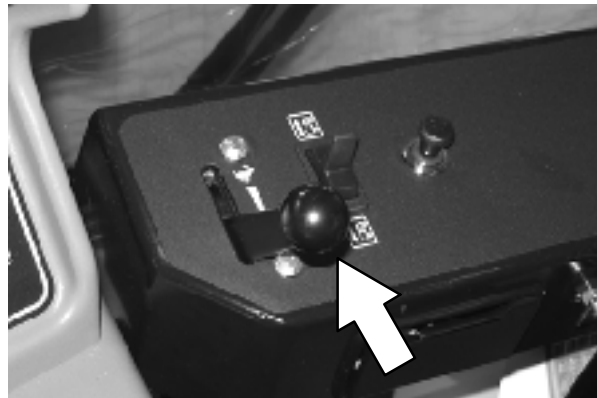

3. Press and hold the *hopper tilt back switch* until the hopper is in the fully tilted position. An audio alarm will sound when the hopper is moving.

NOTE: The hopper will not lift or tilt unless the parking brake is set or the service brake is applied.

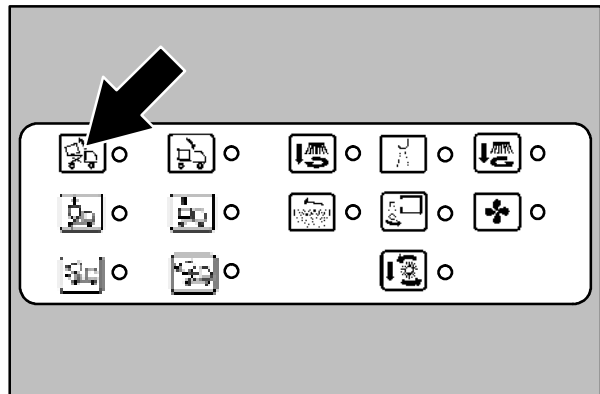

351926

4. Remove the hopper support pin from the storage location on the right rear fender and place it into the hole of the hopper support cylinder.

 **WARNING: Raised hopper may fall. Engage hopper support pin.**

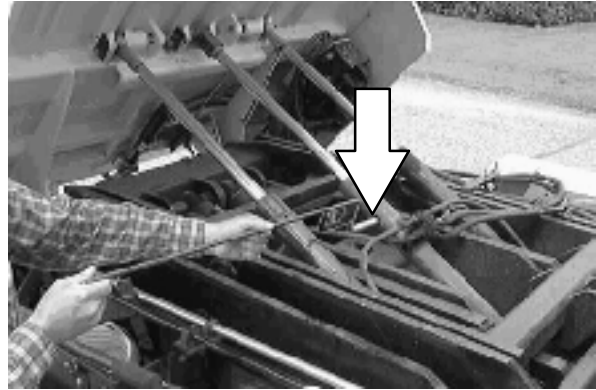

5. Pull the throttle lever back to the idle position, then turn the ignition switch key counter-clockwise to stop the engine. Remove the switch key.

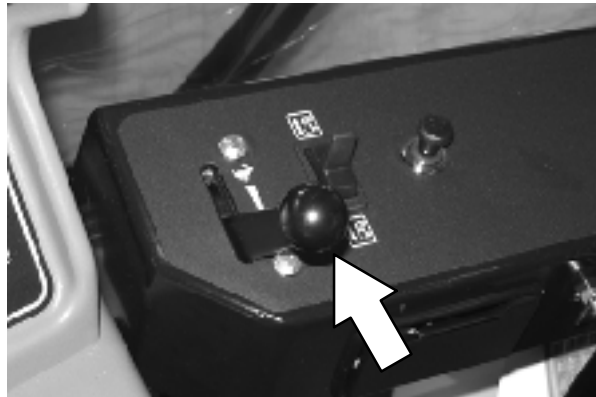

6. Turn the ignition switch key counter-clockwise to stop the engine. Remove the switch key.

FOR SAFETY: Before leaving or servicing machine, stop on level surface, set parking brake, turn off machine and remove key.

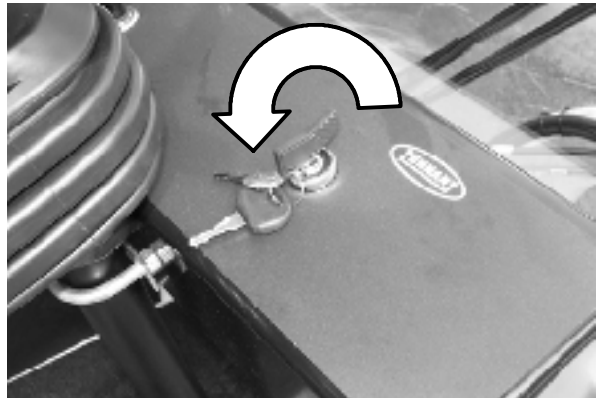

OPERATION

DISENGAGING HOPPER SUPPORT PIN

1. Remove the hopper support pin and fasten it in the storage location on the right rear fender.

 **WARNING:** Lift arm pinch point. Stay clear of hopper lift arms.

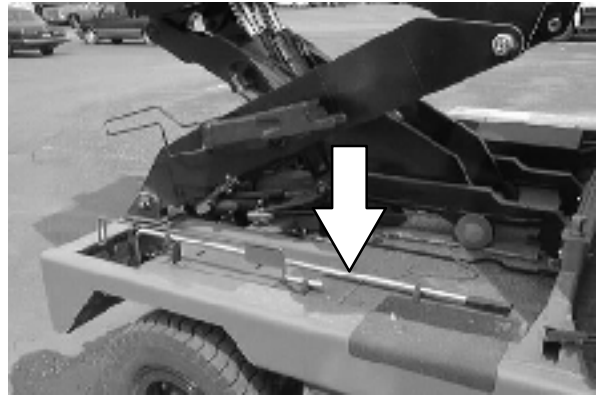

2. Start the engine and push the throttle lever forward to increase the engine speed.

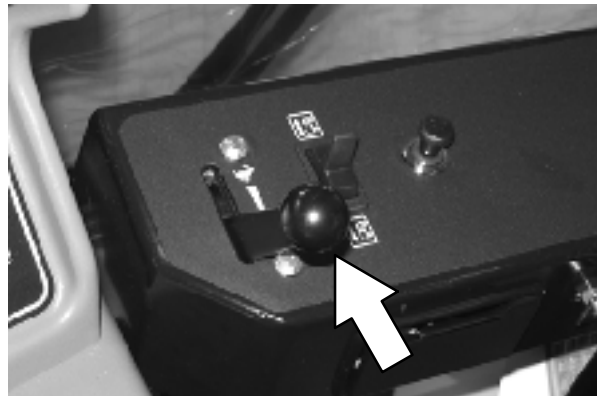

3. Press and hold the *hopper tilt forward switch* until the hopper is fully forward. An audio alarm will sound when the hopper is moving.

NOTE: The hopper will not lift or tilt unless the parking brake is set or the service brake is applied.

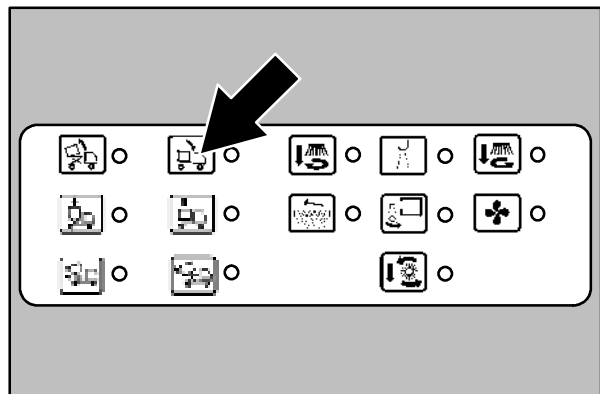

351926

4. Pull the throttle lever back to the idle position, then turn the ignition switch key counter-clockwise to stop the engine. Remove the switch key.

ENGAGING HOPPER SUPPORT BAR (High Dump Model)

1. Press on the top part of the *parking brake switch* to set the parking brake.

FOR SAFETY: Before leaving or servicing machine, stop on level surface, set parking brake, turn off machine and remove key.

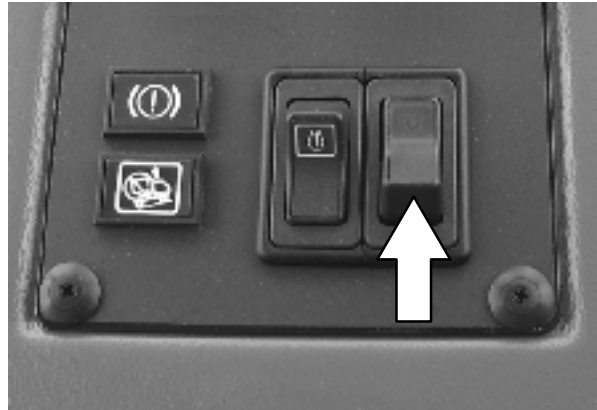

2. Start the engine and push the throttle lever forward to increase the engine speed.

3. Press and hold the *hopper lift switch* until the hopper is in the fully raised position, then release the switch. An audio alarm will sound when the hopper is moving.

NOTE: The hopper will not lift or tilt unless the parking brake is set or the service brake is applied.

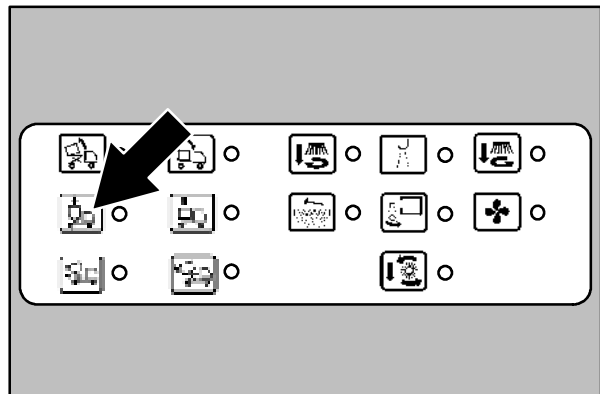

351926

4. Remove the hopper support bar from the storage location on the right side of the lift arms.

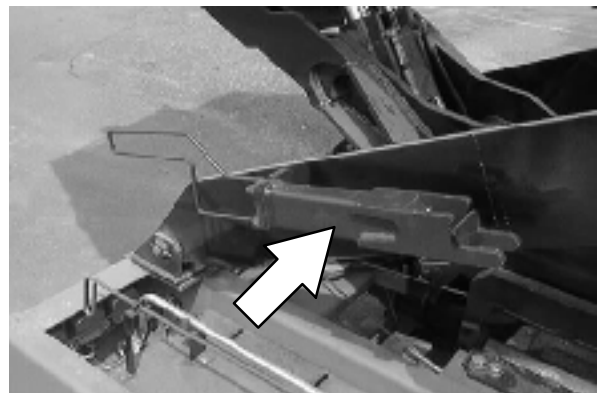

OPERATION

5. Install the support bar from the rear of the machine by first placing it behind the horizontal bar of the lift arms.

 **WARNING: Raised hopper may fall. Engage hopper support bar.**

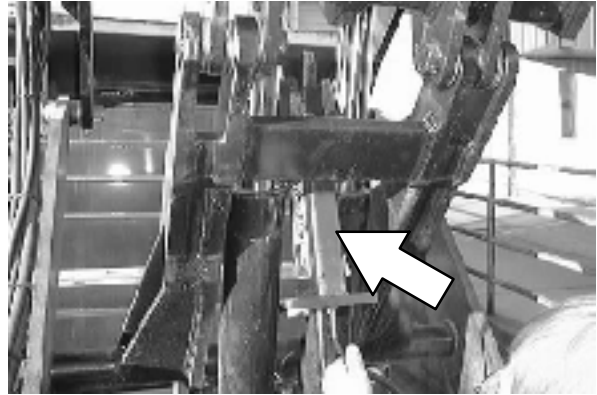

6. Align the tabs of the support bar with the shaft of the lift arms. The longer tabs go toward the front of the machine.

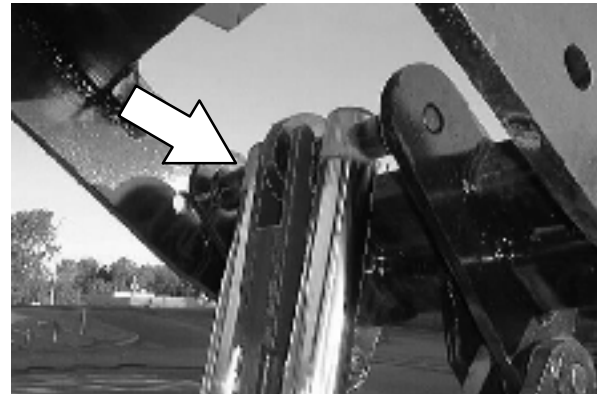

7. Place the base part of the support bar on top of the lift cylinders. Then release the bar.

8. Pull the throttle lever back to the idle position, then turn the ignition switch key counter-clockwise to stop the engine. Remove the switch key.



DISENGAGING HOPPER SUPPORT BAR (High Dump Model)

1. Remove the support bar from lift arms and fasten it in the storage location on the right rear fender.

WARNING: Lift arm pinch point. Stay clear of hopper lift arms.

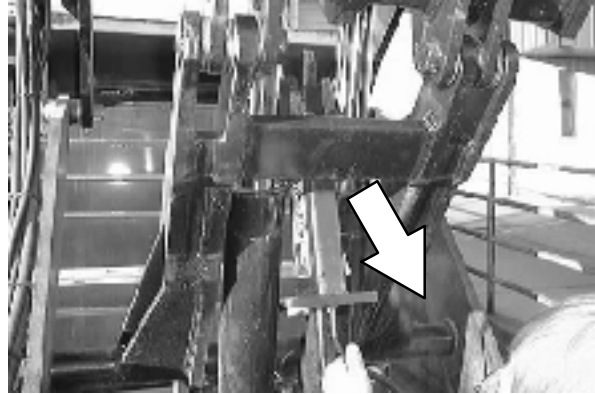

2. Start the engine and push the throttle lever forward to increase the engine speed.

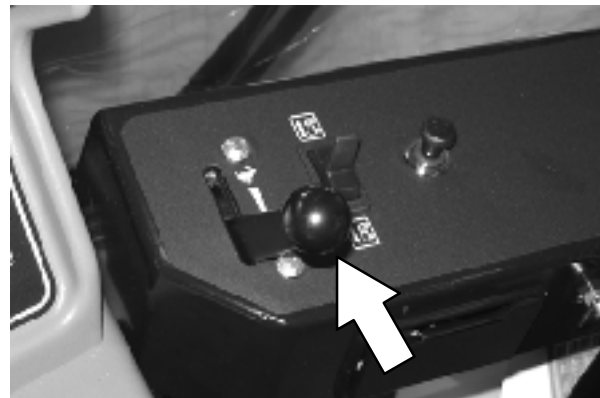

3. Press and hold the *hopper lower switch* until the hopper is fully lowered, then release the switch. An audio alarm will sound when the hopper is moving.

NOTE: The hopper will not lift or tilt unless the parking brake is set or the service brake is applied.

4. Pull the throttle lever back to the idle position, then turn the ignition switch key counter-clockwise to stop the engine. Remove the switch key.

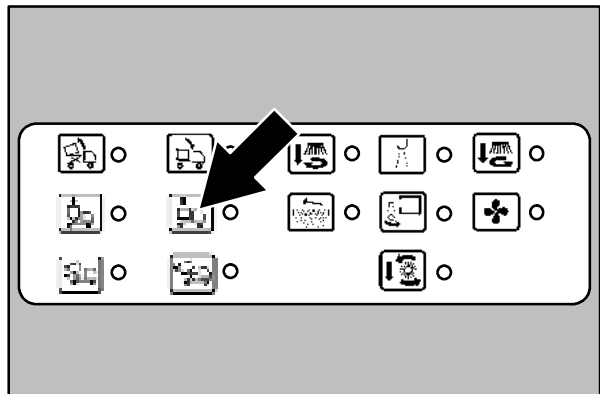

351926

OPERATION

OPERATION ON INCLINES

Drive the machine slowly on inclines and make sure your seat belt is fastened. Use the brake pedal to control machine speed on descending inclines.

The maximum rated incline when driving the machine with the hopper down is 11° (20%).

Do not drive the machine on inclines with the hopper raised.

FOR SAFETY: Move machine with care when hopper is raised.

The *incline light* will come on when the machine is on an incline that is unsafe for high dumping the hopper. It will come on when the front to back incline is more than 11° (20%) and the side to side incline is more than 4°. The machine will not high dump when this light is on.

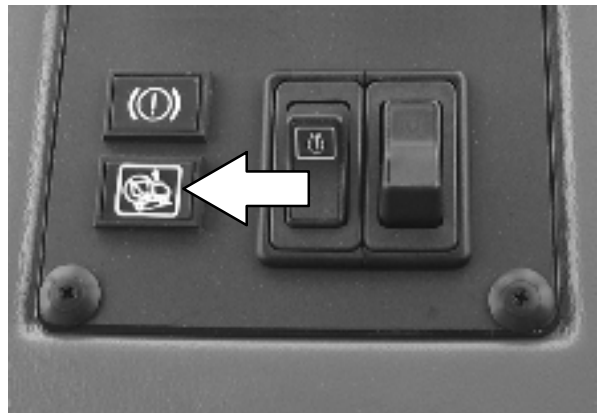

OPTIONS

VARIO SWEEPING BRUSH

The *Vario Sweeping Brush* allows side brush sweeping on the left or right side of the machine. The brush arm moves along the front of the machine. The brush angle, movement, front and side tilt, and direction of rotation are adjusted for the right or left side.

NOTE: The brush arm is locked to the front of the machine during transport. Make sure to take the hair cotter pin from the lock pin before the brush is operated.

WARNING: Brush linkage pinch points. Stay clear when linkage is moving.

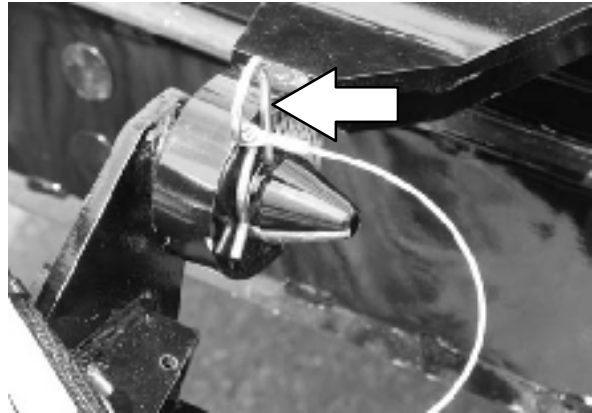

1. Start the brush with the *Vario Sweeping Brush on-off switch*. Push the right part of the switch to rotate the brush counterclockwise. Push the left part of the switch to rotate the brush clockwise.



2. Move the *Vario Sweeping Brush* from the storage position with the joystick. Then use *Vario Sweeping Brush tilt/arm switch* and the joystick to move the brush to the desired left-right and up-down position.

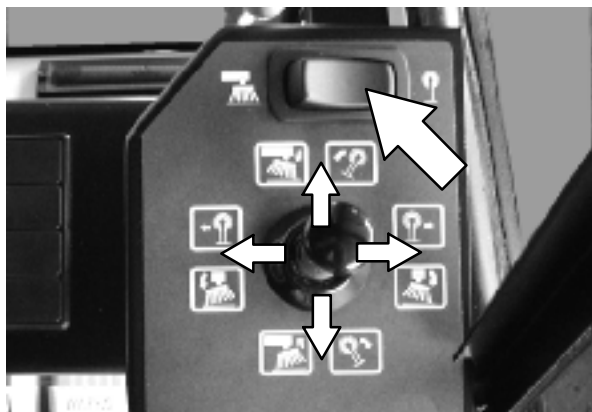

OPERATION

3. Set the *Vario Sweeping Brush tilt/arm switch* to the sweeping brush arm position. Slide or swing the *Vario Sweeping Brush* to the right or left side of the machine as needed with the *Vario Sweeping Brush joystick*.

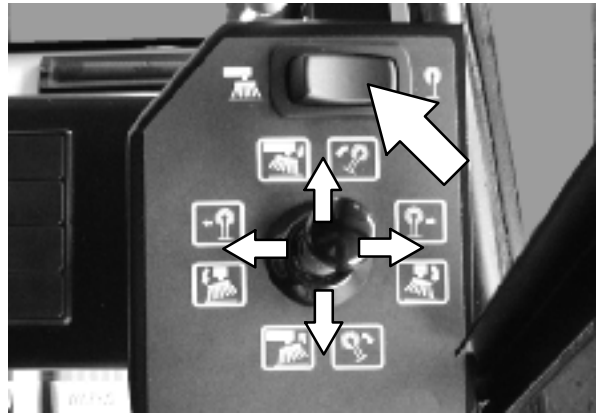

4. Set the *Vario Sweeping Brush tilt/arm switch* to the brush tilt position and adjust the front and side angle of the brush with the *Vario Sweeping Brush joystick*.

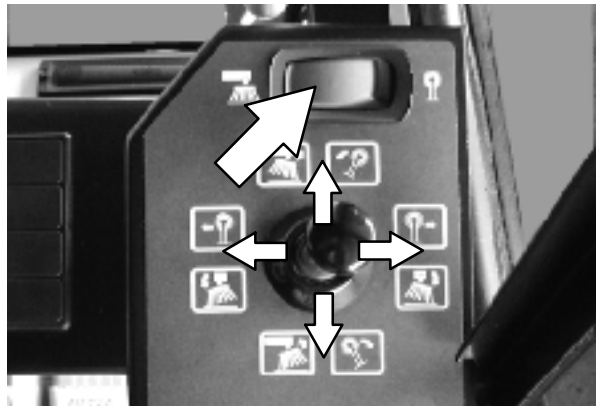

WET DUST CONTROL SYSTEM

The *wet dust control system* is useful in dusty conditions to control the dust created by the side brushes and *Vario Sweeping Brush*. The system consists of a water tank, a water pump, and spray nozzles for each of the side brushes.

1. Press on the top part of the *parking brake switch* to set the parking brake and turn the machine off.

FOR SAFETY: Before leaving or servicing machine, stop on level surface, set parking brake, turn off machine and remove key.

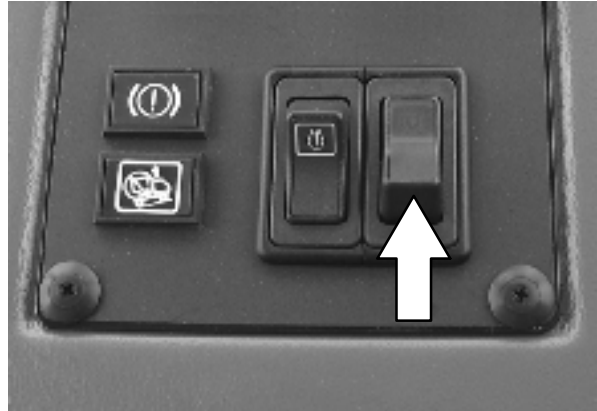

2. Fill the water tank. The fill spout is located in behind the engine access door on the right side of the machine.

⚠ WARNING: Flammable materials can cause explosion or fire. Do not use flammable materials in tank. Only use water.

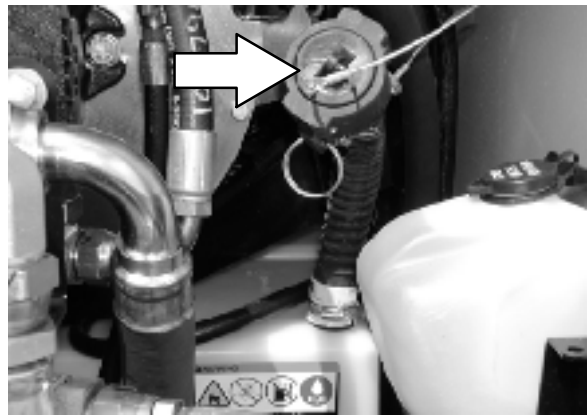

3. The water level can easily be seen on the side of the water tank. The water tank is located behind the access door on the left side of the machine.

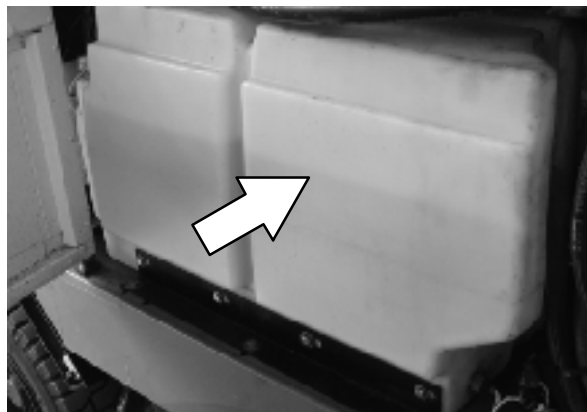

OPERATION

4. Start the machine and turn on the water pump with the *water pump switch*. The light next to the switch will come on.

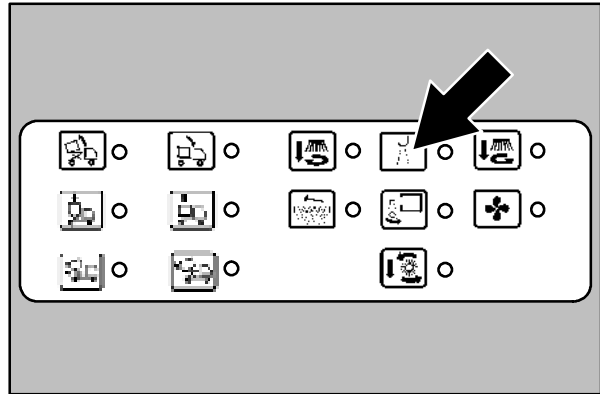

351926

5. Adjust the amount of water spray to each of the brushes with the water valve knobs. Turn the water valve knob clockwise until it comes to a complete stop to close the water supply. If this is NOT done when the machine is shut off, water will continue to flow.

NOTE: The water pump switch needs to be on for the water valves to operate.

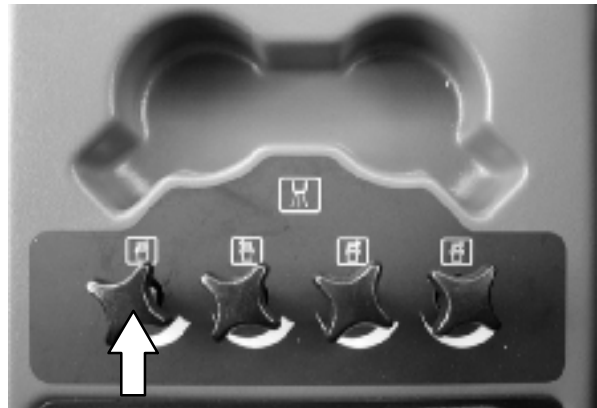

6. The optional *water tank low light* will come on when the water level is low in the tank. The water pump will shut off soon after this light comes on.

NOTE: Do not use the water system on wet roads. Turn off the water pump and water valves.

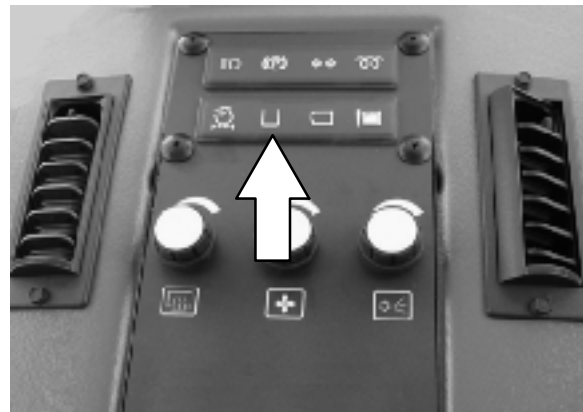

VACUUM WAND

The vacuum wand uses the machine's vacuum system to allow the pick-up of debris that is out of reach of the machine.

1. Press on the top part of the *parking brake switch* to set the parking brake.

FOR SAFETY: Before leaving or servicing machine, stop on level surface, set parking brake, turn off machine and remove key.

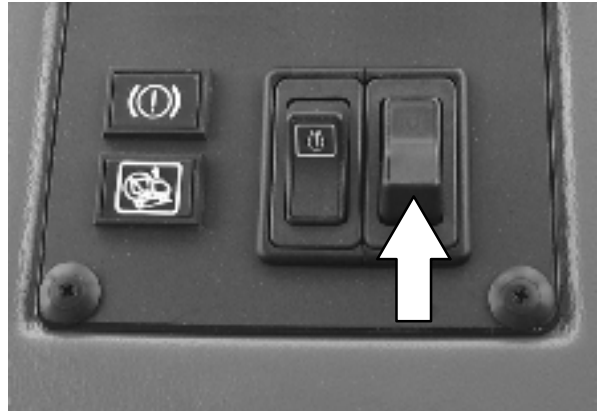

2. Press and hold the *hopper tilt back switch* until the hopper is tilted enough to allow the vacuum door to open.

NOTE: The hopper will not lift or tilt unless the parking brake is set or the service brake is applied.

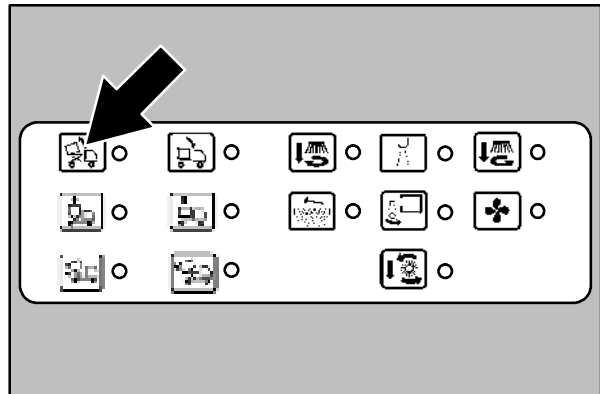

351926

3. Remove the vacuum wand door tool from the storage location on the right rear fender.

WARNING: Lift arm pinch point. Stay clear of hopper lift arms.

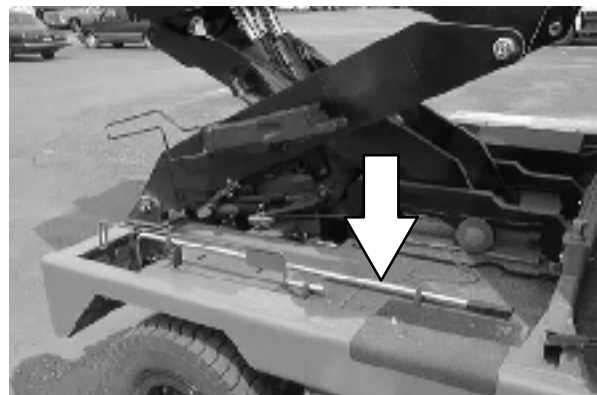

OPERATION

4. Close the vacuum door with the vacuum wand door tool. Place the tool back in its storage location under the hopper.

⚠ WARNING: Conveyor throws debris. Conveyor pinch point. Stay clear when in operation.

NOTE: Do not engage sweep mode while the vacuum wand door is covering the conveyor opening. Damage to the machine can occur.

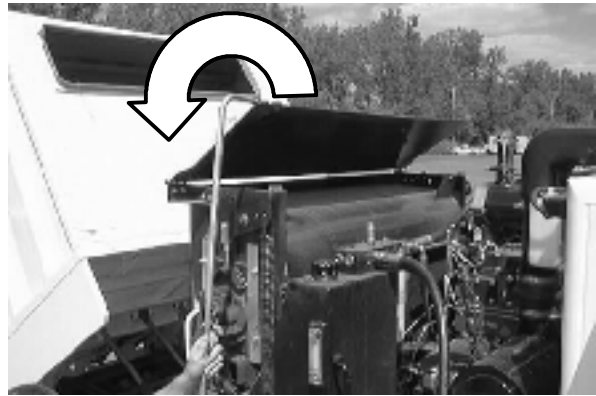

5. Press and hold the *hopper tilt forward* switch until the hopper is fully forward.

NOTE: The hopper will not lift or tilt unless the parking brake is set or the service brake is applied.

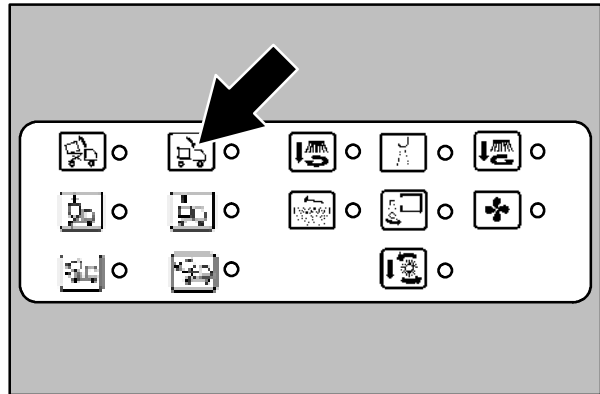

351926

6. Press the *vacuum fan* switch to turn on the vacuum fan. The light next to the switch will come on.

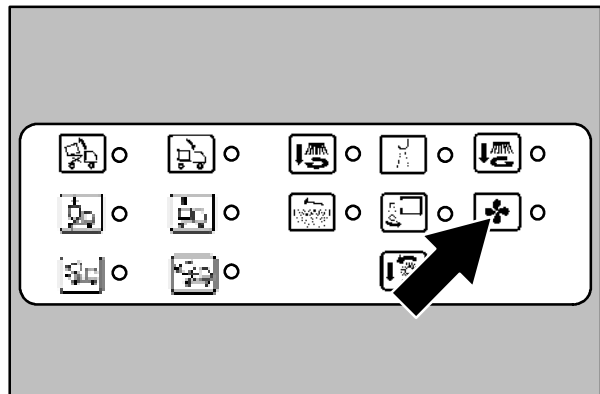

351926

7. Move the *throttle lever* until the engine speed is between 2300 - 2400 RPM.

⚠ WARNING: Machine can emit excessive noise. Consult with your regulatory agency for exposure limits. Hearing loss can result. Wear hearing protection.

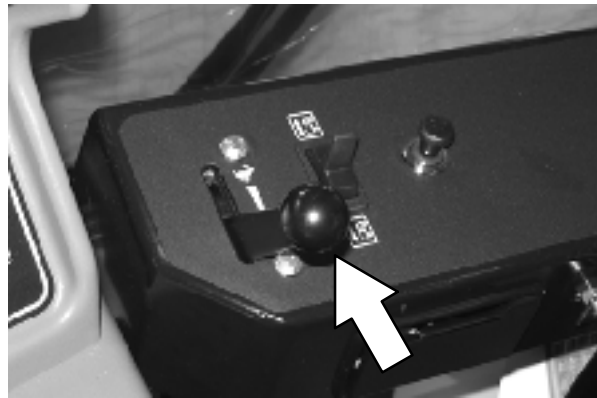

8. Remove the wand from the hopper door and vacuum as required.
9. Place the vacuum wand back on the hopper door when finished.

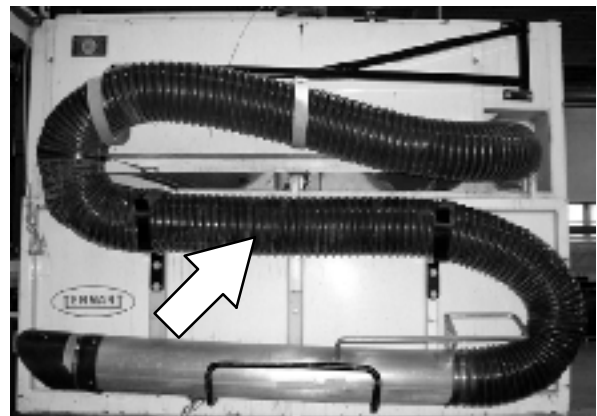

10. Pull the throttle lever to the idle position.
11. Press the *vacuum fan switch* to turn off the vacuum fan. The light next to the switch will turn off.
12. Press and hold the *hopper tilt back switch* until the hopper is in the fully tilted position.
13. Open the vacuum door with the vacuum wand door tool. Place the tool back in the storage location on the right rear fender.

⚠ WARNING: Lift arm pinch point. Stay clear of hopper lift arms.

14. Press and hold the *hopper tilt forward switch* until the hopper is fully forward.

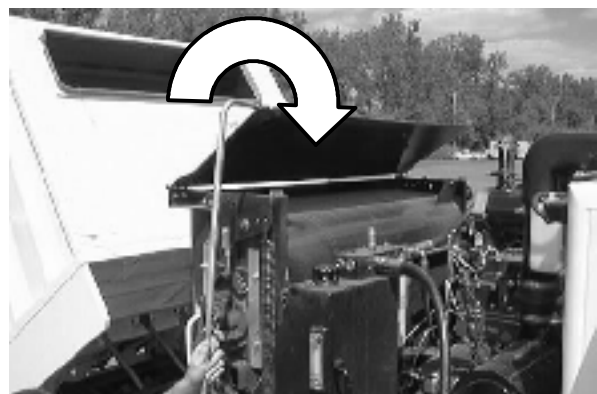

OPERATION

CAB JACK

The *cab jack* allows the cab to be raised without the aid of an overhead hoist or crane.

1. Press on the top part of the *parking brake switch* to set the parking brake and turn the machine off.

FOR SAFETY: Before leaving or servicing machine, stop on level surface, set parking brake, turn off machine and remove key.

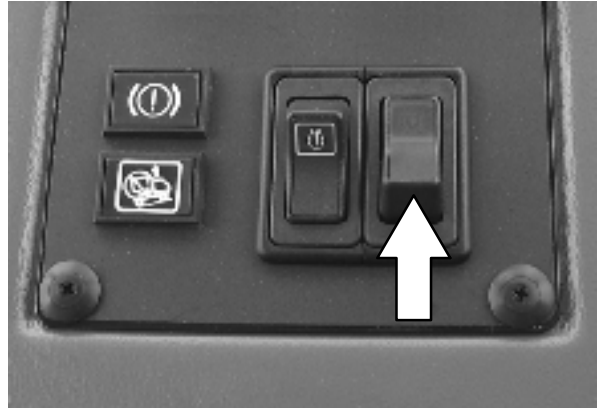

2. Secure or remove all loose items from inside the cab.
3. Disconnect both door springs from the back of the cab. The springs can remain attached to the doors.

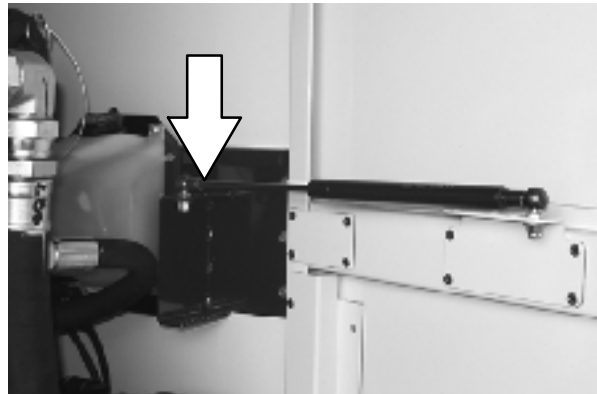

4. Block the windshield wiper hose with a small cable tie or clamp.

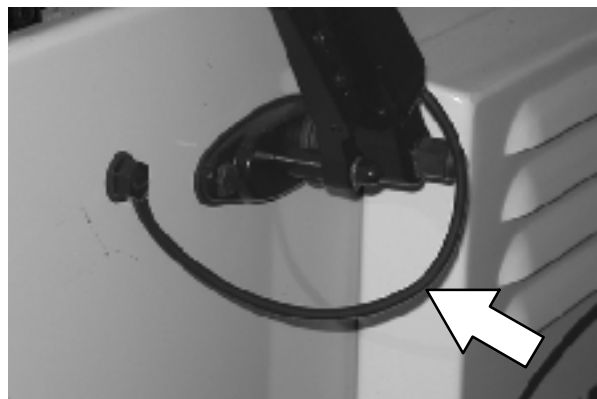

5. Remove the hardware securing the rear of the cab.



6. Locate the cab jack handle near the left door of the machine. Insert it into the cab jack, twist the handle clockwise, and pump the cab to the fully elevated position. Engage the cab support bar.

 **WARNING: Raised cab may fall. Engage cab support bar.**

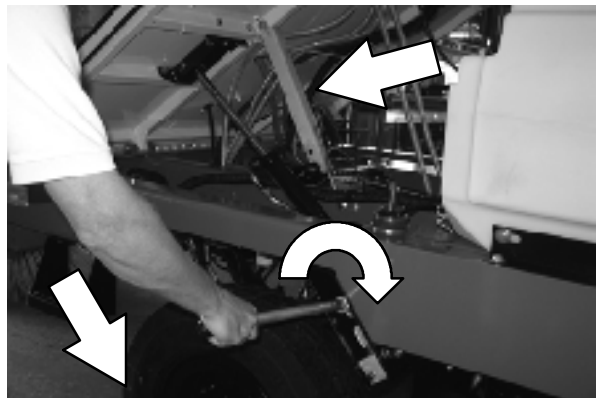

7. To lower the cab, disengage the cab support bar and twist the handle counter clockwise.



8. Reinstall the hardware to secure the cab, remove the cable tie from the windshield wiper fluid hose, and reinstall both door springs to the back of the cab.

OPERATION

TILTING THE CAB (MANUALLY)

The cab can be tilted forward to access components under the cab. The cab must be tilted manually with an overhead hoist if the machine is not equipped with the cab jack option.

CAUTION; DO NOT ATTEMPT TO TILT THE CAB WITHOUT THE USE OF AN OVERHEAD MOTORIZED TROLLEY HOIST.

FOR SAFETY: Before leaving or servicing machine, stop on level surface, set parking brake, and turn off machine.

1. Secure or remove all loose items from inside the cab.
2. Disconnect both door springs from the back of the cab. The springs can remain attached to the doors.

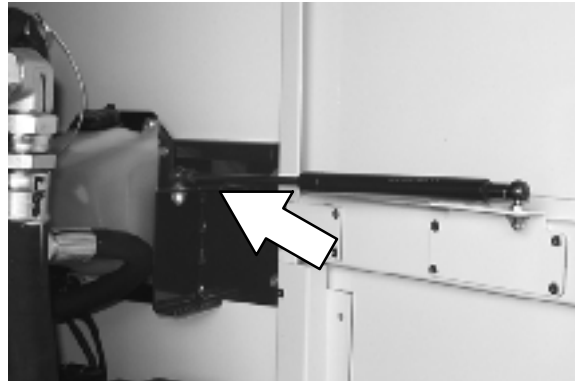

3. Block the windshield wiper hose with a small cable tie or clamp.

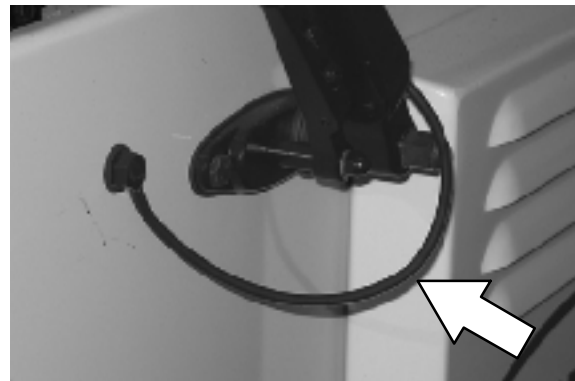

4. Remove the hardware securing the rear of the cab.



5. Attach a chain from the overhead hoist to the hook on the top rear part of the cab. Tilt the cab far enough to engage the cab support bar.

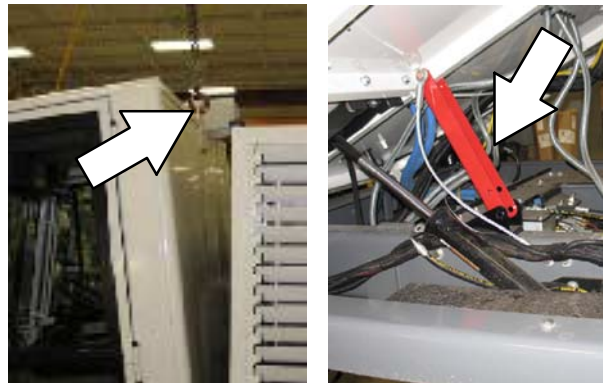

6. Align the lower hole of the support bar with the machine frame, then engage the cab support bar by installing the pin into lower hole.

⚠ WARNING: Raised cab may fall. Engage cab support bar.

7. Keep the chain from the overhead hoist attached as added support.

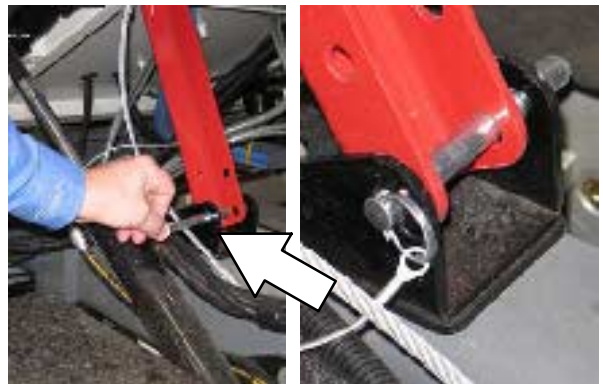

OPERATION

MACHINE TROUBLESHOOTING

Problem	Cause	Remedy
Machine does not start	Directional lever in forward or reverse	Place directional lever in neutral
	Glow plug not heated	Heat glow plug
	Fuel tank empty	Fill fuel tank
	Engine oil pressure too low	Check engine oil level
	Engine temperature too high	Check coolant level
Excessive dusting	Brush skirts and dust seals worn, damaged, out of adjustment	Replace or adjust brush skirts or dust seals
	Hopper dust filter clogged	Shake and/or clean or replace dust filter
	Hopper not down completely	Lower hopper completely
	Hopper rear door open	Close and latch hopper rear door
	Vacuum wand door closed	Open vacuum wand door
	Vacuum fan not on	Turn vacuum fan on
	Vacuum fan failure	Contact TENNANT service personnel
	Thermo Sentry tripped	Reset Thermo Sentry
	Water tank empty	Fill water tank
	Wet dust water pump or valves not turned on	Turn on the wet dust control water pump and valves
	Wet dust control filter clogged	Clean or replace filter
	Sweeping functions keep raising and turning off	Engine speed too fast
Sweep switch will not activate	Hopper raised or not fully forward	Lower and move hopper fully forward
	Engine throttle to high	Decrease engine throttle
Hopper will not lift or tilt	Machine on too steep of an incline	Move machine to a level surface
	Park or service brake not applied	Apply park or service brake
	Hopper overloaded	Remove debris from hopper
	Engine throttle too low	Increase engine throttle
Machine will not propel	Brake pressure too low	Contact service personnel
	Operator not in seat	Sit in seat
	Parking brake on	Release parking brake
	Directional lever in neutral	Move directional lever in forward or reverse position

MACHINE TROUBLESHOOTING

Problem	Cause	Remedy
Poor sweeping performance	Brush bristles worn	Replace brushes
	Wrong sweeping brush	Contact TENNANT representative for recommendations
	Main, side or vario brushes not adjusted properly	Adjust main, side or vario brushes
	Main, side or vario brush drive failure	Contact TENNANT service personnel
	Debris caught in main brush drive mechanism or conveyor	Free drive mechanism or conveyor of debris
	Conveyor in reverse	Switch conveyor to forward direction
	Conveyor failure	Contact TENNANT service personnel
	Conveyor skirts worn or damaged	Replace conveyor skirts
	Hopper full	Empty hopper
	Hopper not down completely	Lower hopper completely
	Hopper rear door open	Close and latch hopper rear door
	Vacuum wand door closed	Open vacuum wand door
	Vacuum fan not on	Turn vacuum fan on
	Vacuum fan failure	Contact TENNANT service personnel
	Worn brush skids	Replace brush skids
Brush skids not completely down	Check for obstruction then lower skids completely	

MAINTENANCE

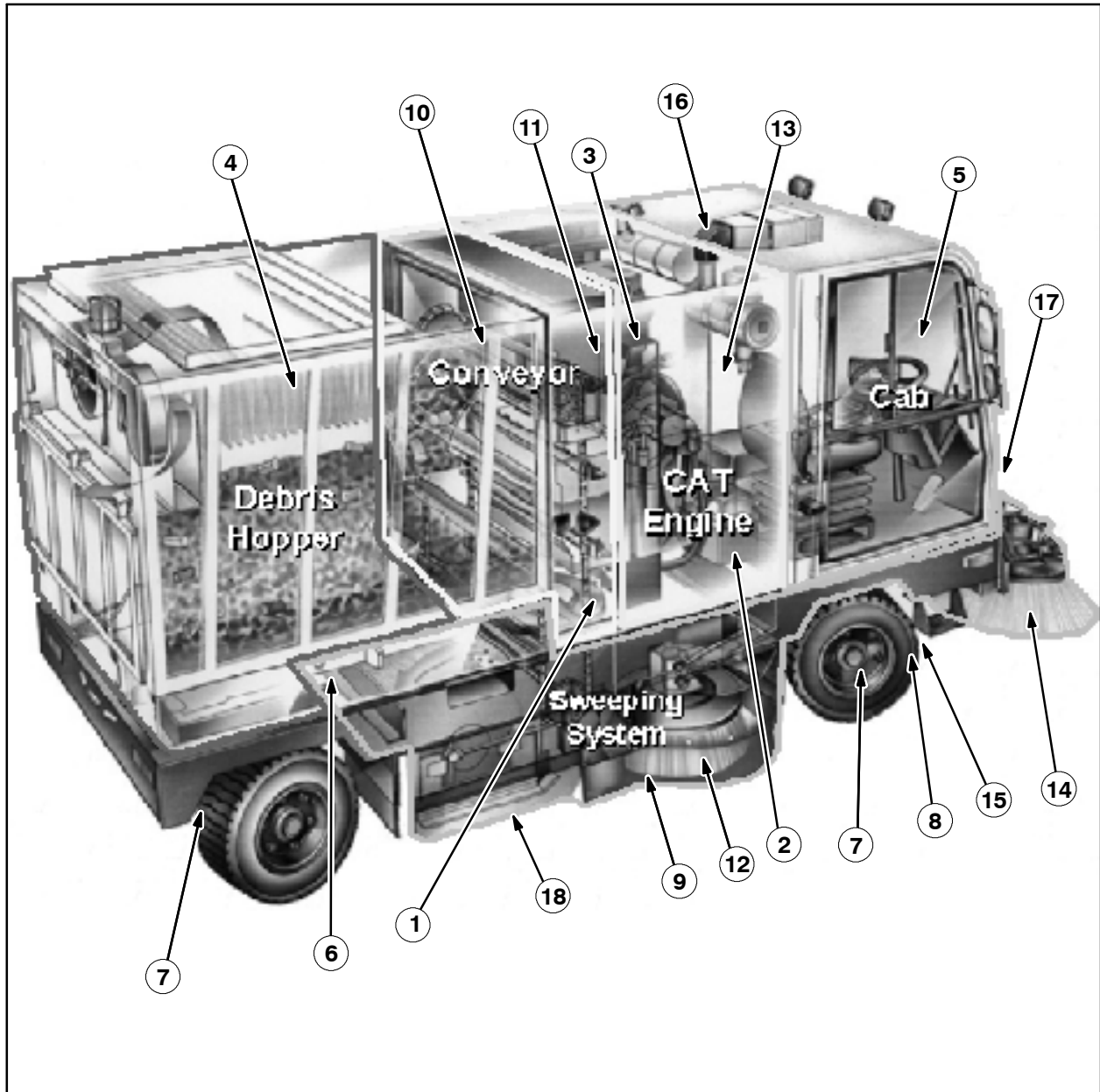

NOTE: Numbered references for maintenance chart pages 87, 88.

MAINTENANCE CHART

Interval	Key	Description	Procedure	Lubricant/ Fluid	No. of Service Points	
Daily	10	Conveyor	Check chain and ratchetts	-	2	
			Lubricate chain	EO	2	
			Wash internally	-	1	
			Lubricate bearings	WBG	4	
	10	Conveyor skirts and paddles	Check for damage and wear	-	All	
	16	Engine air intake screen	Check and clean	-	1	
	3	Engine crankcase	Check oil level	EO	1	
	3	Fuel water separator	Check for water, drain	-	1	
	3	Radiator	Check and clean core exterior	-	1	
			Check coolant level in overflow reservoir	WG	1	
	3	Hydraulic fluid cooler	Check and clean cooler fins	-	1	
	3	Air conditioner condenser (option)	Check and clean cooler fins	-	1	
	11	Hydraulic fluid reservoir	Check fluid level	HYDO	1	
	9	Brush compartment skirts	Check for damage and wear	-	3	
			Main brush	Check for damage, wear, and adjustment	-	1
				Check brush pattern	-	1
				Lubricate support rods	-	1
12	Side brush(es)	Check for damage and wear	-	1-3		
4	Hopper dust filter	Shake	-	1		
13	Windshield washer reservoir	Check fluid level	WF	1		
50 Hours	3	Fuel lines and clamps	Check for tightness and wear	-	1	
	7	Tires	Check pressure	-	4	
	8	Steering	Check wheel alignment	-	1	
	17	Cab filters	Clean	-	1	
	1	Main brush/conveyor lift	Purge hydraulic fluid air	-	1	
100 Hours	9	Brush compartment, conveyor and hopper seals, skid flap	Check for damage or wear	-	All	
	3	Alternator/fan belt	Check tension	-	1	
	3	Air conditioner belt (option)	Check tension	-	1	
	3	Engine air filter	Check the dust cap	-	1	
	6	Hopper tilt	Lubricate	WBG	8	
	6	Hopper lift (option)	Lubricate	WBG	13	
	7	Wheels	Check wheel nut torque	-	4	
18	Skids	Check for wear	-	2		

MAINTENANCE

Interval	Key	Description	Procedure	Lubricant/ Fluid	No. of Service Points
200 Hours	3	Radiator hoses and clamps	Check for tightness and wear	-	2
	8	Steering	Lubricate steering cylinder	WBG	2
	8	Suspension	Lubricate leaf springs and pivots	WBG	16
	14	Vario sweeping brush	Lubricate rotation and guides	WBG	2
	12	Side brush(es)	Lubricate pivot	WBG	2
	7	Tires	Check wear and rotate	-	4
	-	Hydraulic hoses	Check for wear and damage	-	All
	2	Battery	**Clean and tighten battery cable connections	-	1
	8	Wet dust control system (option)	Clean water filter	-	1
	5	Windshield wiper blades	Check for wear	-	2
250 Hours	3	Engine crankcase	**Change oil and filter element	EO	1
	3	Fuel filter	Replace	-	1
400 Hours	15	Differential	Check oil level	-	1
	7	Service brakes	Check fluid level	-	4
800 Hours	11	Hydraulic reservoir	Replace filler cap	-	1
1000 Hours	3	Engine valves	Valve lash adjustment	-	1
1200 Hours	16	Hydraulic fluid filter	* Change filter element	-	All
1600 Hours	15	Differential	Change gear lubricant	GL	1
	7	Service brakes	Change fluid level	UTF	4
	3	Cooling system	Flush	WG	1
2400 Hours	15	Hydraulic fluid reservoir	* Replace suction strainer	-	1
			* Change hydraulic fluid	HYDO	1

NOTE: Change the hydraulic fluid, filter, and suction strainer, indicated (), after every 800 hours for machines NOT originally equipped with **TennantTrue** premium hydraulic fluid. (See Hydraulics section).*

*NOTE: Also check procedures indicated (**) after the first 50-hours of operation, and procedures indicated (*) after the first 250 hours of operation.*

LUBRICANT/FLUID

UTF . . . Universal tractor fluid (Mobil 424)

EO . . . Engine oil, API diesel classification CG4 or better

HYDO . **TennantTrue** premium hydraulic fluid or equivalent

WBG . . Waterproof bearing grease (TENNANT part no. 765819)

WG . . . Distilled water, coolant conditioner (TENNANT part no. 770172) and permanent-type ethylene glycol anti-freeze, -34° C (-30° F)

WF . . . Automotive-type windshield washer fluid

GL . . . SAE 90 weight gear lubricant (Grade GL5)

NOTE: More frequent intervals may be required in extremely dusty conditions.

LUBRICATION

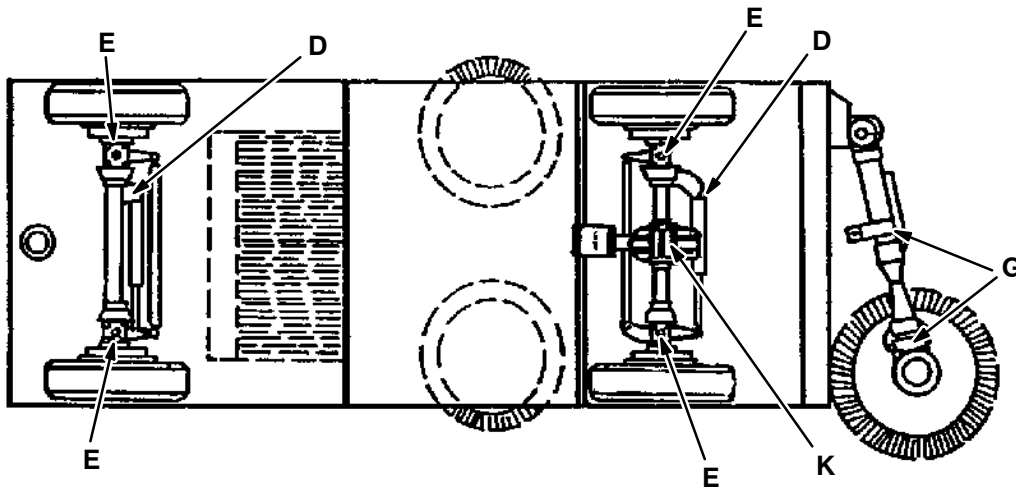
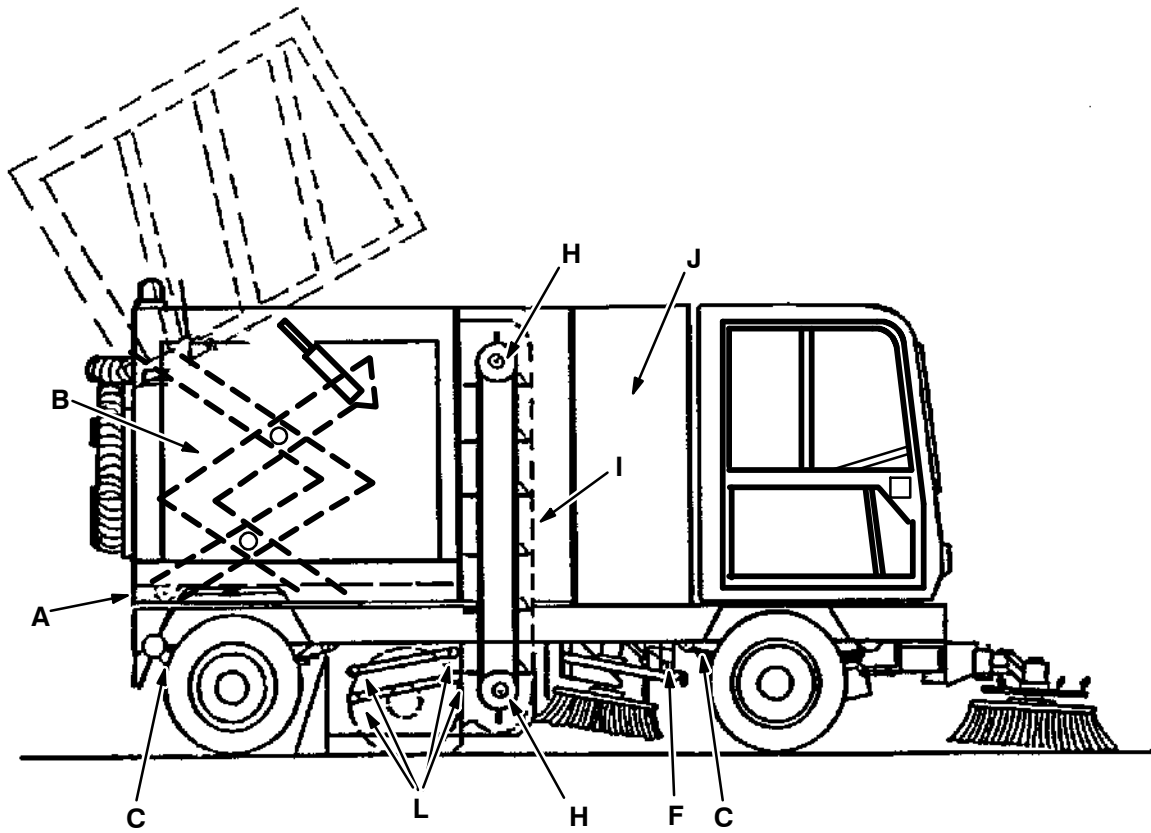

351930

NOTE: Lettered references for lubrication section of manual pages 89 thru 94.

MAINTENANCE

A. HOPPER TILT (LOW DUMP)

The hopper tilt has eight grease fittings. Four grease fittings are located on the tilt cylinders, one on each end of the two cylinders. Two grease fittings are located on the hopper safety support cylinders, one at each end. The last two grease fittings are located at the hopper tilt pivot, one on each side. Lubricate these fittings with Waterproof Bearing grease (TENNANT part no. 765819) after every 100 hours of operation.

 **WARNING: Raised hopper may fall.**
Engage hopper support pin.

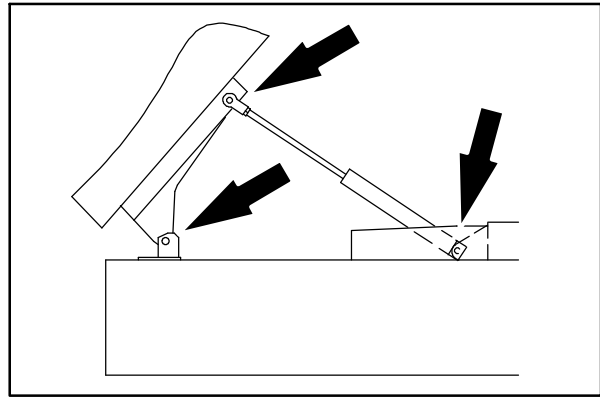

351933

B. HOPPER LIFT/TILT (HIGH DUMP OPTION)

The high dump hopper lift has thirteen grease fittings. Four grease fittings are located on the upper tilt cylinders, one on each end of the two cylinders. Two grease fittings are located on the lower lift cylinders, one at each base. One grease fitting is located at the top of the hopper safety support cylinder. Two grease fittings are located at the hopper tilt pivot, one on each side. The last four grease fittings are located on the cross shaft pivots of the hopper lift arms, one at each of the four pivots. Lubricate these fittings with Waterproof Bearing grease (TENNANT part no. 765819) after every 100 hours of operation.

 **WARNING: Raised hopper may fall.**
Engage hopper support bar.

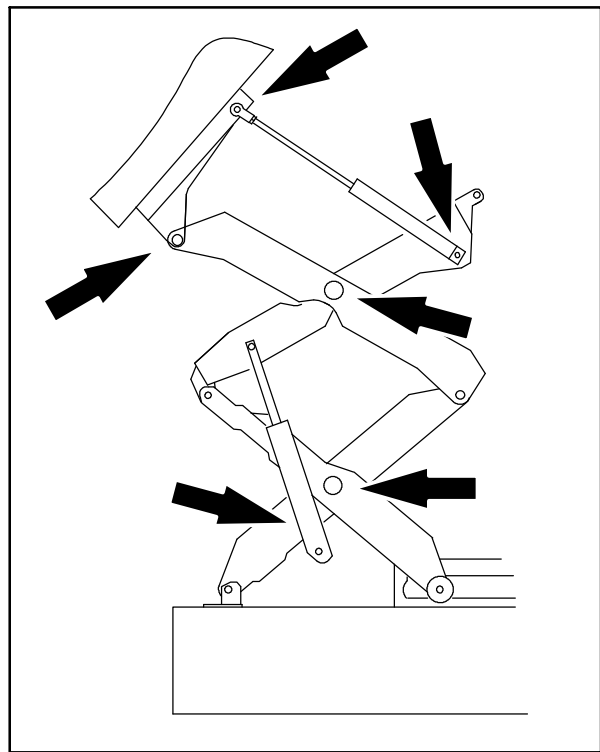

351932

C. AXLE LEAF SPRINGS

The axle leaf springs have twelve grease fittings. Lubricate with Waterproof Bearing grease (TENNANT part no. 765819) after every 200 hours of operation.

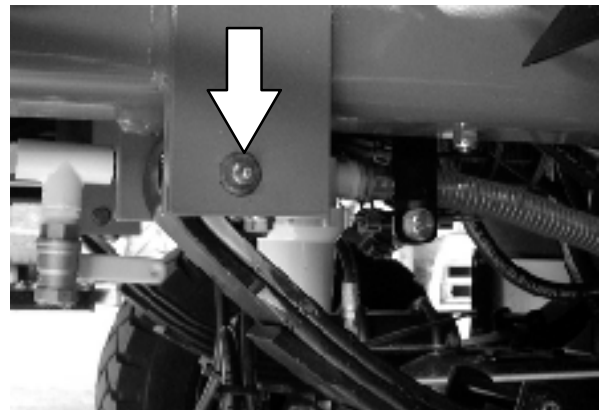

D. STEERING CYLINDER

Each steering cylinder has one grease fitting. Lubricate with Waterproof Bearing grease (TENNANT part no. 765819) after every 200 hours of operation.

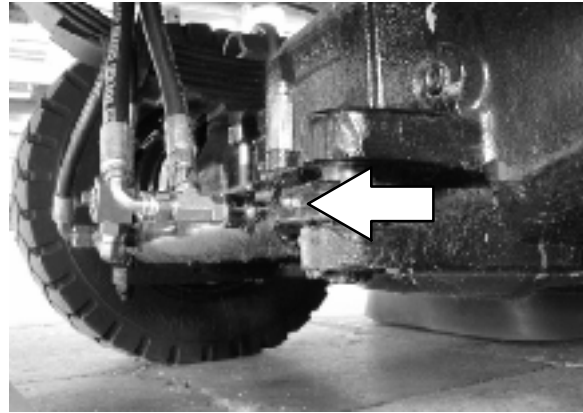
**E. WHEEL PIVOTS POINTS**

The wheel pivots points have eight grease fittings. Lubricate with Waterproof Bearing grease (TENNANT part no. 765819) after every 200 hours of operation.

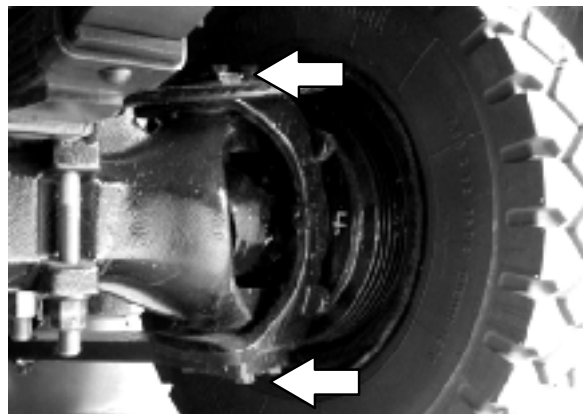
**F. SIDE BRUSH PIVOT**

Each side brush pivot has a grease fitting. Lubricate with Waterproof Bearing grease (TENNANT part no. 765819) after every 200 hours of operation.

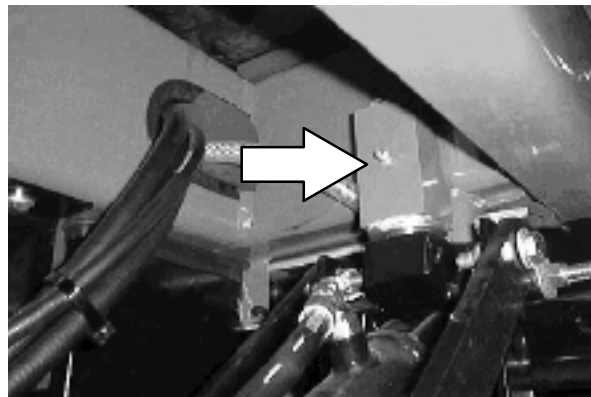

MAINTENANCE

G. VARIO SWEEPING BRUSH (OPTION)

The brush pivot has two grease fittings. Lubricate with Waterproof Bearing grease (TENNANT part no. 765819) after every 200 hours of operation.

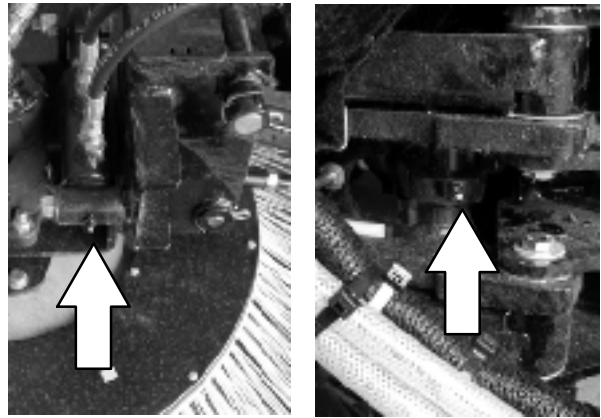

H. CONVEYOR BEARINGS

There are four bearing grease fittings. Lubricate daily with Waterproof Bearing grease (TENNANT part no. 765819).

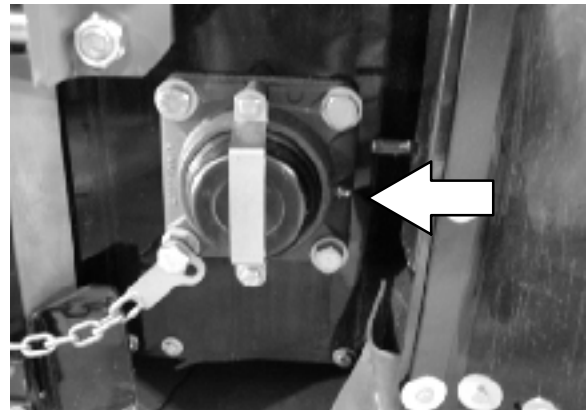
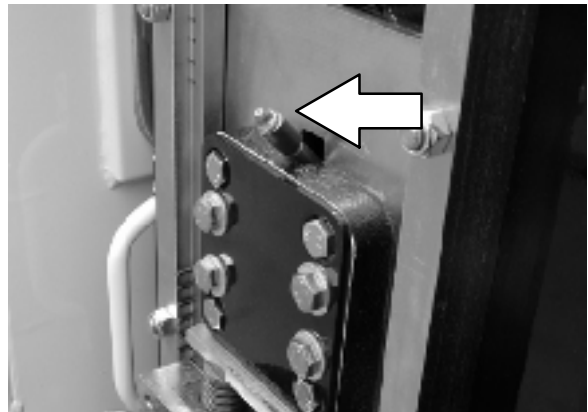

I. CONVEYOR CHAIN

The conveyor chains should be lubricated with engine oil daily.

Remove the access covers on the sides of the conveyor. Run the conveyor in reverse at idle. Oil the chain making sure to lubricate the o-rings on the chain. Put the access covers back on the sides of conveyor.

FOR SAFETY: When servicing machine, avoid moving parts. Do not wear loose jackets, shirts, or sleeves.

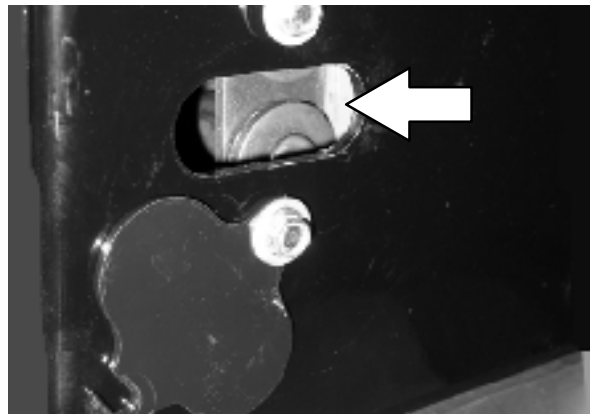

J. ENGINE

Check the engine oil level daily. The engine oil dipstick can be accessed behind the right side engine access door.

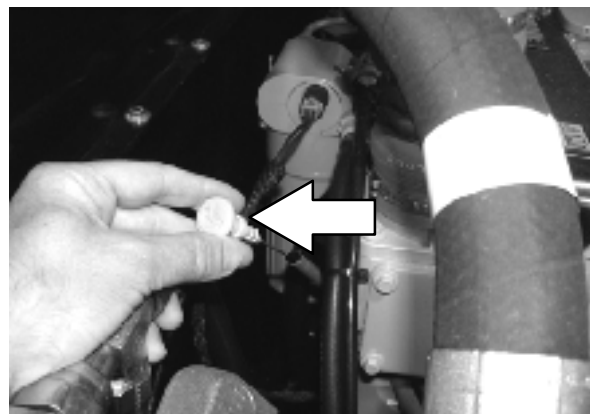

Change the engine oil and oil filter after the first 50 hours of operation, then after every 250 hours of machine operation after that. Use 10W30 API CG4/CH4, ACEA E3/E5 rated engine oil.

The engine oil drain is accessed through the right side door.

Fill the engine with oil to the level indicated on the oil dipstick. The engine oil capacity is 11.7 L (12.4 qt) including the oil filter.

FOR SAFETY: When servicing machine, avoid moving parts. Do not wear loose jackets, shirts, or sleeves.

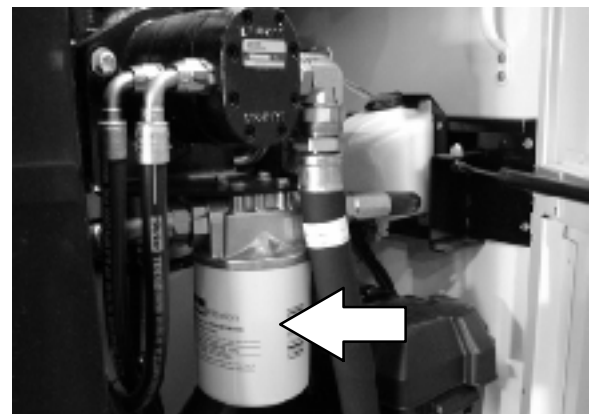

MAINTENANCE

K. DIFFERENTIAL

Check the lubricant level in the differential after every 400 hours of operation by removing the filler plug.

Change the differential lubricant after every 1600 hours of operation. Use SAE 90 weight gear lubricant.

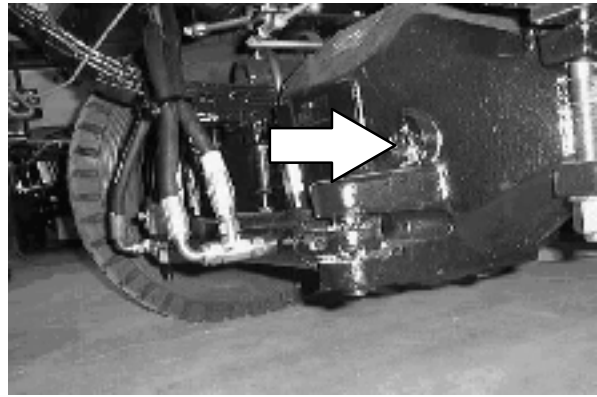

L. MAIN BRUSH SUPPORT RODS

The main brush support rods have a total of eight grease fittings, four on each side. Lubricate with Waterproof Bearing grease (TENNANT part no. 765819) daily.

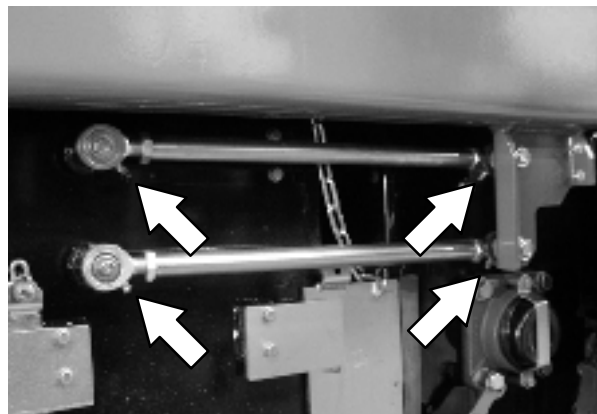

HYDRAULICS

HYDRAULIC FLUID RESERVOIR

The reservoir is located on the right side of the machine next to the engine.

Check the hydraulic fluid level at *operating temperature* daily. Make sure the hopper is down when checking hydraulic fluid level. The sight gauge is marked with full, the black line, and add, the red line, levels to indicate the level of hydraulic fluid in the reservoir. Cold fluid level is mid-point of add and full lines.

ATTENTION! Do not overfill the hydraulic fluid reservoir or operate the machine with a low level of hydraulic fluid in the reservoir. Damage to the machine hydraulic system may result.

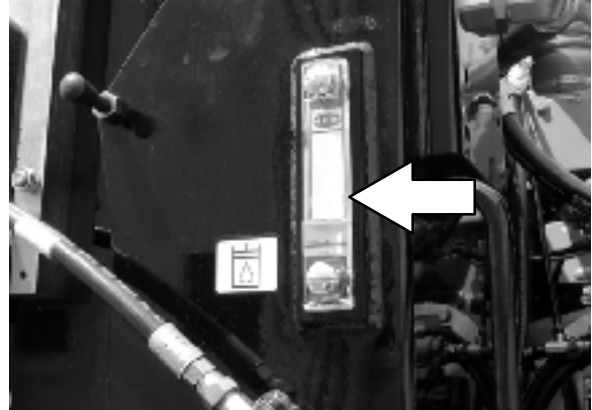

Mounted on top of the reservoir is a filler cap with a built-in breather. Replace the cap after every 800 hours of operation.

Lubricate the filler cap gasket with a film of hydraulic fluid before putting the cap back on the reservoir.

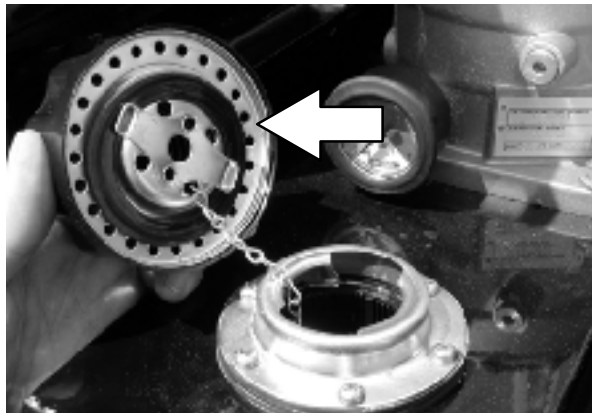

Drain and refill the hydraulic fluid reservoir with new **TennantTrue** premium hydraulic fluid after every 2400 hours of operation. Machines have a blue colored drop (left photo) on the hydraulic fluid label if originally equipped with **TennantTrue** premium hydraulic fluid.



TennantTrue Fluid



Previous Fluid

NOTE: Change the hydraulic fluid, filter, and suction strainer after every 800 hours for ALL machines that have NOT consistently used **TennantTrue** premium hydraulic fluid or equivalent.

MAINTENANCE

The reservoir has a built-in strainer outlet that filters hydraulic fluid before it enters the system. Replace the strainer after every 2400 hours of operation.

The hydraulic fluid filter gauge is located in front of the hydraulic filter, on top of the hydraulic reservoir. Make sure the fluid is at operating temperature and the machine is at 2000 RPM to ensure a proper reading.

Replace the hydraulic fluid filter element after every 1200 hours of operation, or when the hydraulic filter gauge reads outside of the green area.



REPLACING HYDRAULIC FLUID FILTER

The reservoir is located on the right side of the machine next to the engine.

1. Loosen or remove the hydraulic reservoir breather cap.
2. Remove the hydraulic fluid reservoir filter cover.
3. Allow the oil to drain from the filter into the tank. (Allow to drain for approx. 5 minutes).
4. Lift the filter and internal bowl out of the reservoir and place into an oil pan. Remove the top part of the filter element.

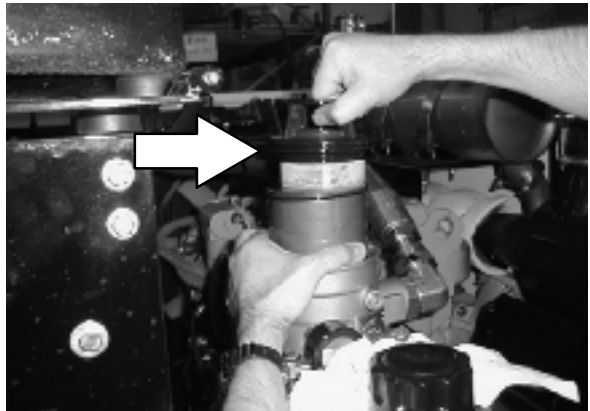

5. Pour out any residual oil into the oil pan.

6. Remove and replace the filter element.

7. Replace the new filter element and internal bowl assembly back into the hydraulic fluid reservoir.



HYDRAULIC FLUID

There are two fluids available ~~for different temperature ranges:~~

TennantTrue premium hydraulic fluid (Extended Life)			
Part number	Ambient temperature	ISO Grade	Capacity
1057707	below 7° C (45° F) all temperatures	32	3.8 L (1 gal)
1057708	below 7° C (45° F) all temperatures	32	19 L (5 gal)
9000119 Synthetic	all temperatures	68	19 L (5 gal)

If using a locally-available hydraulic fluid, be sure the specifications match the Tennant hydraulic fluid specifications. Substitute fluids can cause premature failure of hydraulic components.

Synthetic fluids offer several advantages. Synthetic fluids can operate in a wider range of extreme temperatures. This feature is advantageous in states with wide seasonal temperature changes.

NOTE: DO NOT Mix Synthetic Hydraulic Fluid With TENNANT TRUE Premium Hydraulic Fluid.

ATTENTION! Hydraulic components depend on system hydraulic fluid for internal lubrication. Malfunctions, accelerated wear, and damage will result if dirt or other contaminants enter the hydraulic system.

MAINTENANCE

HYDRAULIC HOSES

Check the hydraulic hoses every 200 hours of operation for wear or damage.

Fluid escaping at high pressure from a very small hole can be almost invisible, and can cause serious injuries.

See a doctor at once if injury results from escaping hydraulic fluid. Serious infection or reaction can develop if proper medical treatment is not given immediately.

FOR SAFETY: When servicing machine, use cardboard to locate leaking hydraulic fluid under pressure.

If you discover a fluid leak, contact your mechanic/supervisor.

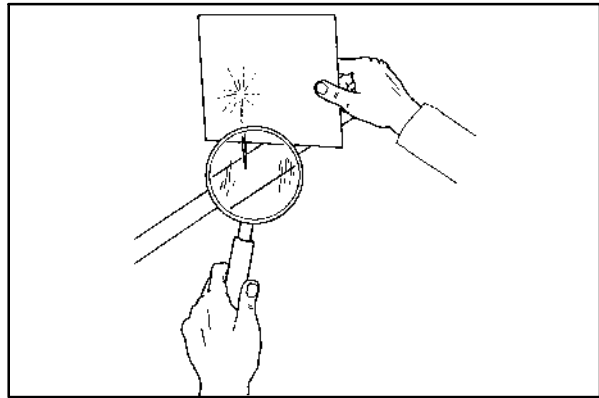

00002

PURGING AIR FROM THE HYDRAULIC CONVEYOR LIFT SYSTEM

If a hydraulic component in the lift system has been replaced, air will get into the hydraulic fluid. This air must be purged from the system.

Purge air from the hydraulic system after a hydraulic component in the lift system has been changed. To purge air from the hydraulic system, start the machine and press the sweep switch to lower the conveyor. Leave the machine in the sweep mode and shut off the machine to collapse the lift cylinders. Turn the ignition switch to ON, but do not start the engine. Press the sweep switch to activate solenoid valve (SV31) on the control block, allowing hydraulic fluid to flow through the valve. Disconnect the hose from the top fitting of the right lift cylinder and drain the hydraulic fluid into a pan to purge air from the hose. Reconnect the hose to the right lift cylinder. Disconnect the hose from the top fitting of the left lift cylinder and drain the hydraulic fluid into a pan to purge air from the hose. Reconnect the hose to the left lift cylinder. Start the engine and check hydraulic system for leaks. Cycle the sweep mode and observe the conveyor lift for proper operation.

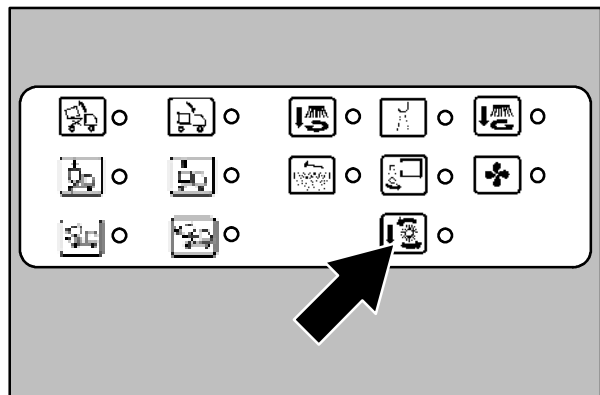

351926

ENGINE

COOLING SYSTEM

Check the radiator coolant level daily in the overflow reservoir. Use distilled water mixed with a permanent-type, ethylene glycol antifreeze to a -34° C (-30° F) rating. Add coolant to the overflow reservoir. Add one pint of conditioner (TENNANT part no. 770172) to each coolant change.

FOR SAFETY: When servicing machine, avoid contact with hot engine coolant.

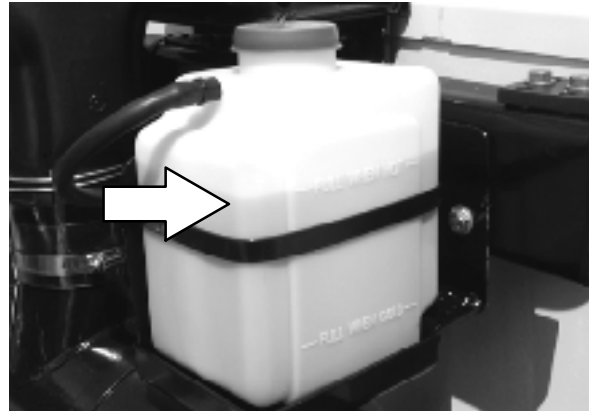

Check the radiator hoses and clamps every 200 hours of operation. Tighten the clamps if they are loose. Replace the hoses and clamps if the hoses are cracked, harden, or swollen.

Check the radiator core exterior and hydraulic cooler fins for debris daily. If the machine is equipped with air conditioning, check the condenser as well. The condenser hinges out for cleaning. Blow or rinse all dust, which may have collected on the radiator or condenser, in through the grille and radiator fins, opposite the direction of normal air flow. Be careful not to bend the cooling fins when cleaning. Clean thoroughly to prevent the fins becoming encrusted with dust. Clean the radiator, cooler, and condenser only after they have cooled to avoid cracking.



FOR SAFETY: When using pressurized air or water, wear eye and ear protection.

ATTENTION! Do not wash the fuel injection pump or turbocharger when the engine is running or warm. This could damage these components.

Flush the radiator and the cooling system every 1600 hours of operation, using a dependable cleaning compound. Add one pint of conditioner (TENNANT part no. 770172) to each coolant change.

MAINTENANCE

AIR FILTER

The engine air filter housing has an end cap, a rubber dust cap and a dry cartridge-type air filter element. Check the dust cap every 100 hours of operation to make sure it is expelling dust. Replace the dust cap if the rubber is worn.

The air filter element must be replaced whenever it is damaged. Inside the air filter element is a safety element. Replace this element, do not clean it, after the regular element has been damaged or changed three times.

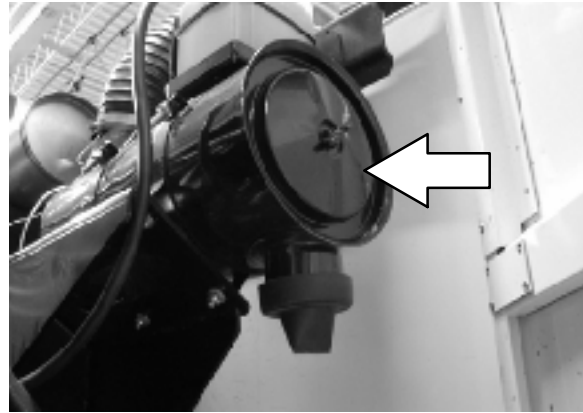

Replace the air filter element only when the *clogged engine air filter light* shows restriction in the air intake system. Do not remove the air filter element from the housing unless it is restricting air flow.

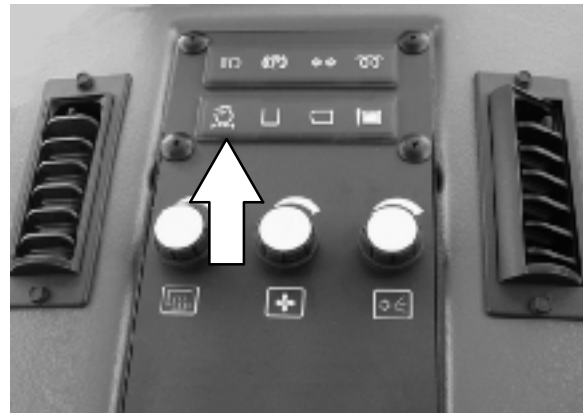

On standard engines, install the end cap on the air filter housing with the rubber dust cap facing downward. On turbo engines, the dust cap is on the housing.

AIR INTAKE SCREEN

Check the *air intake screen* for obstructions daily. It is located on top of the engine air cleaner.

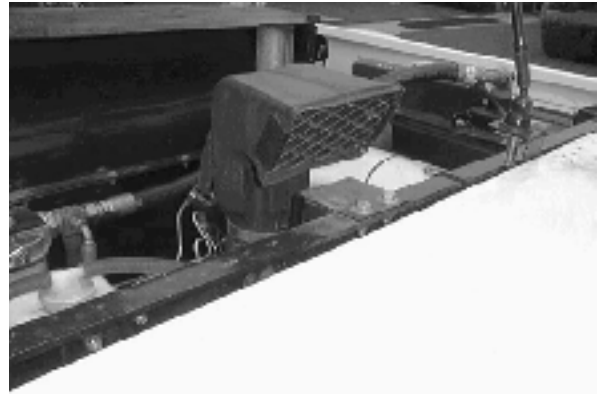

FUEL FILTER

The *fuel filter* has an element that filters impurities from the diesel fuel. It is located on the conveyor side of the engine.

Replace the fuel filter element after every 250 hours of operation.

FOR SAFETY: Keep flames and sparks away from fuel system service area. Keep area well ventilated.

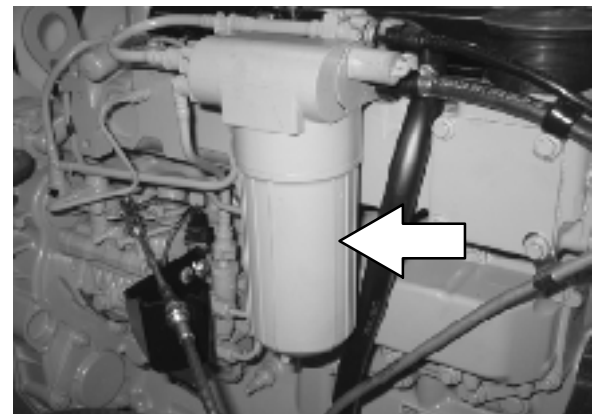

FUEL WATER SEPARATOR

The *fuel water separator* separates water from the diesel fuel. It is located on the bottom of the fuel filter.

Open the separator daily to allow any accumulated water to drain out.

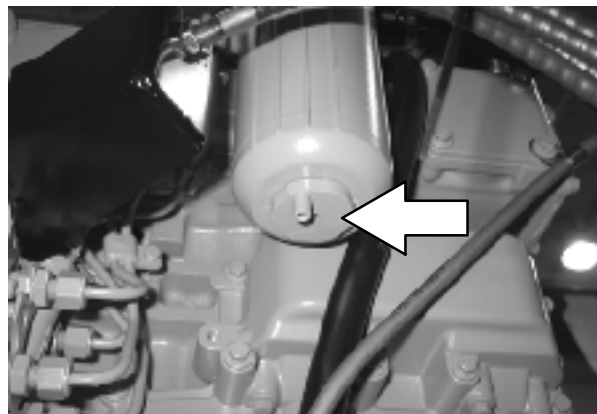

MAINTENANCE

FUEL LINES

Check the fuel lines every 50 hours of operation. If the clamp band is loose, apply oil to the screw of the band, and securely tighten the band.

The fuel lines are made of rubber, and may become worn out whether the engine has been used much or not. Replace the fuel lines and clamp bands every two years.

FOR SAFETY: Keep flames and sparks away from fuel system service area. Keep area well ventilated.

If the fuel lines and clamp bands are found worn or damaged before two years' time, replace or repair them at once. When the fuel lines are not installed, plug both ends with clean cloth or paper to prevent dirt from entering the lines. Dirt in the lines can cause fuel injection pump malfunction.

ENGINE VALVE

Engine valve lash adjustment is required after the first 250 hours of operation, then after every 1000 hours of operation after that. Allow the valves to cool before checking valves.

Refer to the manufacturer's maintenance manual.

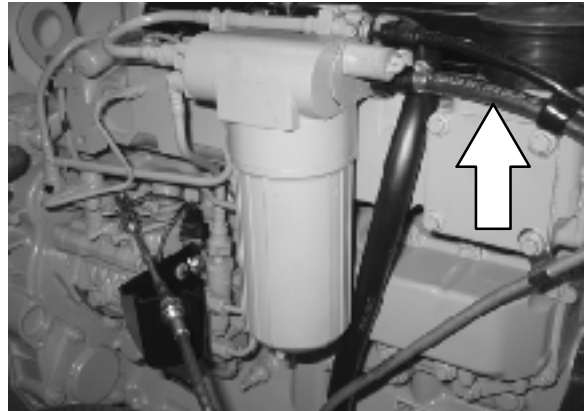

CAB FILTERS

The fresh air cab filters are located in the front of the cab.

 **WARNING: Brush linkage pinch points. Stay clear when linkage is moving.**

Clean these filters with soap and water. Check and clean the cab filters after every 50 hours of operation. Replace when necessary.

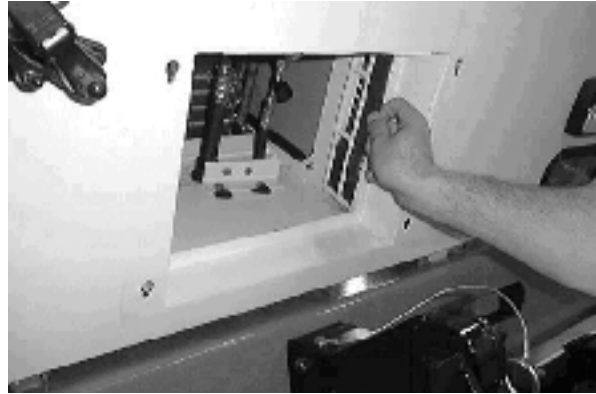

WET DUST CONTROL FILTER (OPTION)

The wet dust control filter is located under the cab between the front wheels.

Clean the water filter every 200 hours of operation by removing it and flushing it with clean water.

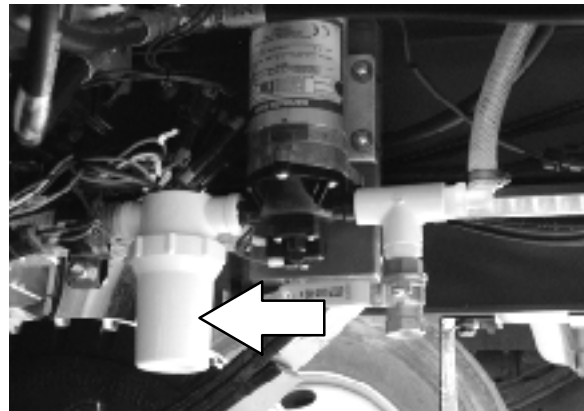

MAINTENANCE

WINDSHIELD WIPER BLADES

Check the windshield wiper blades for wear every 200 hours of operation. Replace when necessary.



WINDSHIELD WASHER FLUID

The windshield washer fluid is located behind the operator cab and can be accessed through the right engine access door. Check the windshield washer fluid level daily. Fill with automotive-type windshield washer fluid.

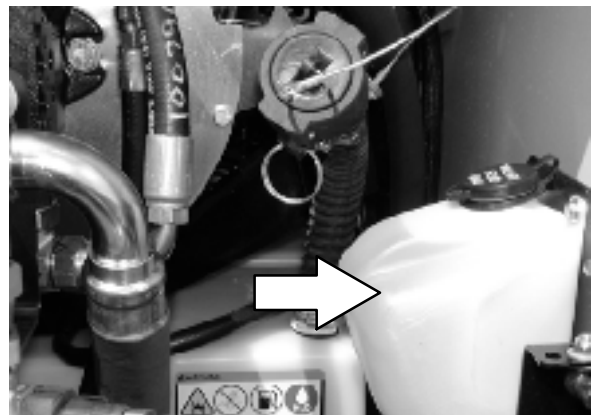

BATTERY

The battery is located behind the operator cab and can be accessed through the right engine access door.

After the first 50 hours of operation, and every 200 hours after that, clean and tighten the battery connections.

FOR SAFETY: When servicing machine, avoid contact with battery acid. Wear eye and ear protection.

NOTE: When the battery is disconnected, the parking brake will come on automatically.



BELTS AND CHAINS

ALTERNATOR/FAN BELTS

The alternator/fan belts are driven by the engine crankshaft pulley and drive the alternator pulley. Proper belt tension is 10 mm (0.40 in) from a force of 4 to 5 kg (8 to 10 lb) applied at the mid-point of the longest span.

Check and adjust the belt tension every 100 hours of operation.

FOR SAFETY: When servicing machine, avoid moving parts. Do not wear loose jackets, shirts, or sleeves.

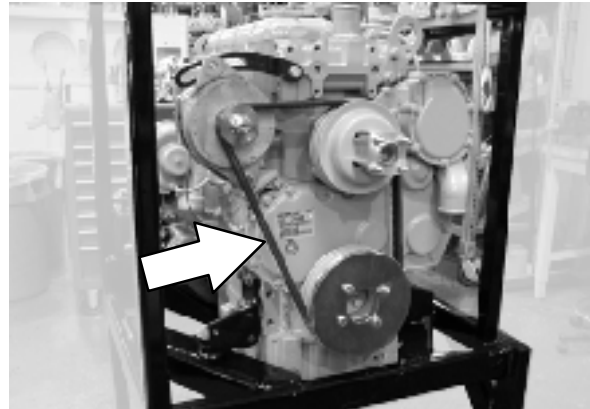

AIR CONDITIONER BELT (OPTION)

The air conditioner belt is driven by the engine crankshaft pulley and drives the compressor. Proper belt tension is 4 mm (0.19 in) from a firm force of a finger applied at the mid-point of the longest span.

Check and adjust the belt tension after the first 10 hours of operation and then every 100 hours after that.

FOR SAFETY: When servicing machine, avoid moving parts. Do not wear loose jackets, shirts, or sleeves.

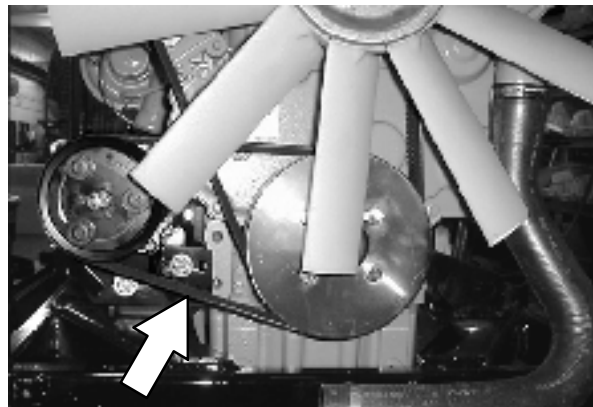

STATIC DRAG CHAIN

A static drag chain prevents the buildup of static electricity in the machine. The chain is attached to the machine at the rear main brush skirt.

Make sure the chain is touching the floor at all times.

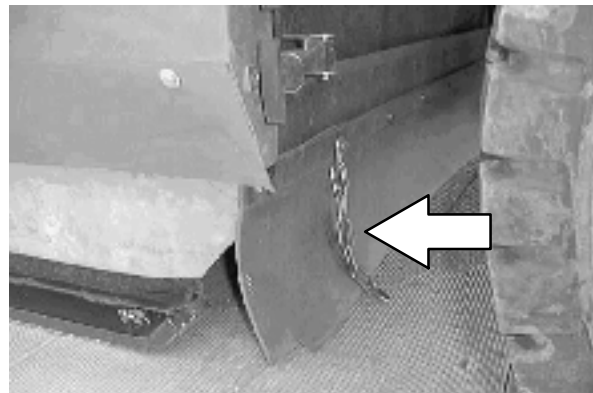

DEBRIS HOPPER

HOPPER DUST FILTER

The hopper dust filter filters the air pulled up from the hopper. The dust filter is equipped with a shaker to remove the accumulated dust particles. To clean the dust filter, with the engine in the idle position, press the *filter shaker switch*.

Shake the dust filter before tilting or dumping the hopper and at the end of every work shift. When sweeping in dusty conditions, shake the filter more often.

Filters may become plugged up with mud and heavy material when sweeping in wet conditions. Light fibrous material can also become inbedded in between the filter pleats.

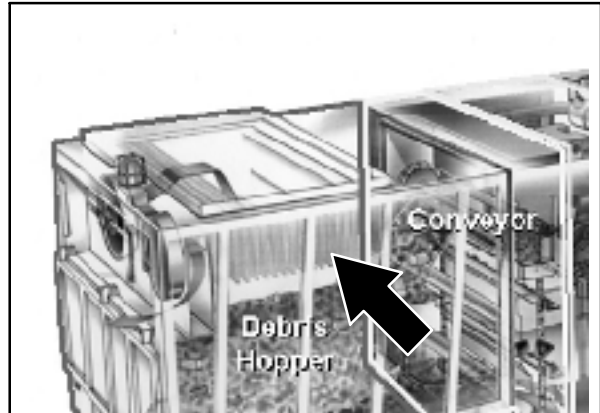

TO CLEAN THE HOPPER DUST FILTER

1. Stop the engine and set the machine parking brake.
2. Tip the hopper back and release the hopper door.
3. Secure the door with the door support cable.
4. Use a garden hose or broom to clean the hopper filter from the inside of the hopper.

TO REMOVE OR REPLACE HOPPER DUST FILTER

1. Stop the engine and set the machine parking brake.

FOR SAFETY: Before leaving or servicing machine, stop on level surface, set parking brake, turn off machine and remove key.

2. Remove the top hopper cover.
3. Remove the nuts holding the filter shaker frame in the hopper.
4. Pull the filter shaker frame and filter out of the hopper.
5. Drill out the rivets holding the filter to the shaker frame.

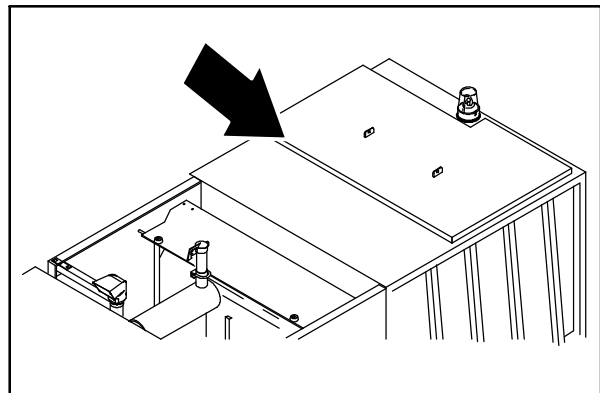

351931

6. Put the new separators into the new filter bag pockets.
7. Take the rods out of the old filter, and put them in the new filter.
8. Put the filter into the shaker frame.
9. Stretch the filter over the edges of the shaker frame. Pull the drawstring tight.
10. Drill and rivet the filter to the shaker frame.
11. Put the filter shaker frame and filter in the hopper.
12. Install the retaining nuts for the filter shaker frame and tighten.
13. Check the seals on the top hopper cover and the hopper. Replace any that is worn or damaged.
14. Put the top hopper cover back on the hopper. Make sure the cover has a good seal before tightening the hardware.

THERMO SENTRY

The Thermo Sentry senses the temperature of the air pulled up from the hopper. It is located at the rear of the hopper. If the air temperature in the hopper reaches $71^{\circ} \pm 3^{\circ} \text{ C}$ ($160^{\circ} \pm 5^{\circ} \text{ F}$), the Thermo Sentry stops the vacuum fan and cuts off the air flow. The sweeping functions will stop, the brushes will raise and the vacuum fan icon will start blinking.

The Thermo Sentry will automatically reset when the air temperature in the hopper falls below $60^{\circ} \pm 3^{\circ} \text{ C}$ ($140^{\circ} \pm 5^{\circ} \text{ F}$).

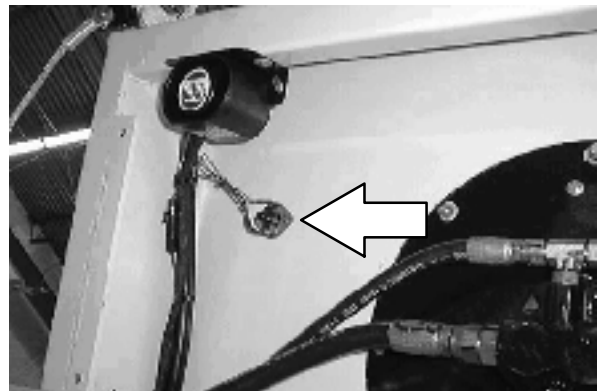

CONVEYOR

The conveyor transports debris picked up by the main brush to the hopper, by means of a paddle system. Check tension, clean and lubricate the conveyor chain daily. To lubricate, refer to the *Conveyor Chain* in the *Lubrication* section of this manual.

The conveyor chain is tensioned automatically while operating, with the hydraulic cylinders. When the sweeping system is turned off, the conveyor is equipped with a locking ratchet mechanism to keep the conveyor chain from disengaging the drive sprockets.

As the conveyor chain wears, the locking ratchet mechanisms move up the pins mounted on the slide rails on both sides of the machine. Clean the ratchet mechanisms daily. Check the ratchet tips and pins for damage and wear daily.

Check the conveyor skirts and paddles for damage and wear daily.



WARNING: Conveyor throws debris. Conveyor pinch point. Stay clear when in operation.

Clean the conveyor thoroughly with a garden hose daily. To do this, tilt the hopper back engage the hopper tilt support bar, and turn the machine power off. Remove the top conveyor panel from rear of the conveyor to access the inside of the conveyor.

FOR SAFETY: When servicing machine, wear eye and ear protection when using pressurized air or water.

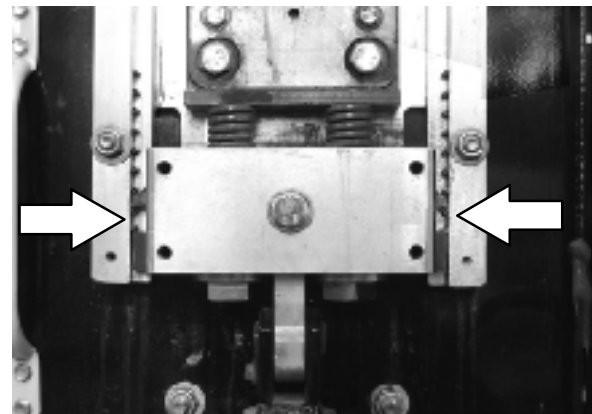
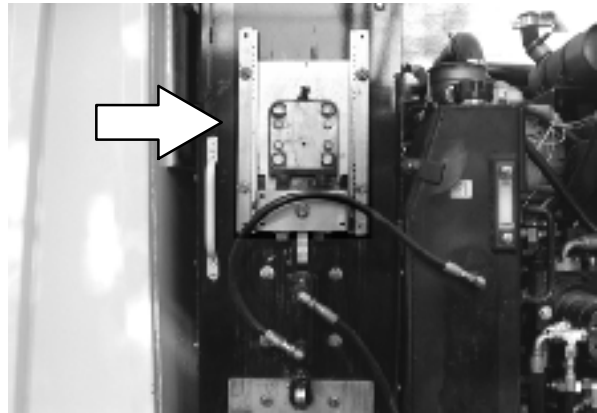

BRUSHES

MAIN BRUSH

The main brush is cylindrical and spans the width of the machine, sweeping debris into the conveyor, which deposits the debris into the hopper.

Check the brush daily for wear or damage. Remove any string or wire tangled on the main brush, main brush drive hub, or main brush idler hub.

Check the main brush pattern daily. Refer to the *TO CHECK AND ADJUST MAIN BROOM PATTERN* section of the manual. The pattern should be 100 to 125 mm (4 to 5 in) wide. Adjust the main brush pattern with the main brush down pressure nut located under the hopper.

Replace the brush when it no longer cleans effectively.

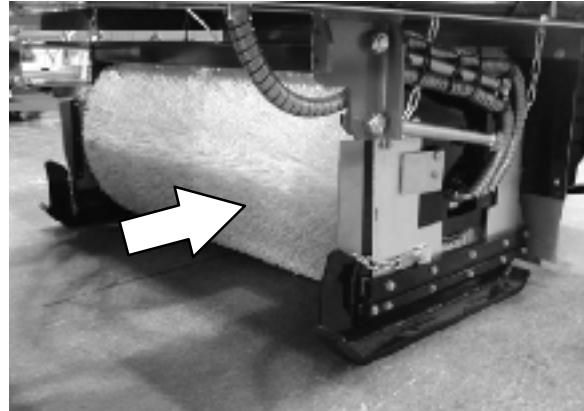

TO REPLACE MAIN BRUSH

1. Park the machine on level ground and set the machine parking brake.
2. Press the *sweep switch* to lower the main brush.

3. Stop the engine.

FOR SAFETY: Before leaving or servicing machine, stop on level surface, set parking brake, turn off machine and remove key.

4. Remove the right side main brush access door.

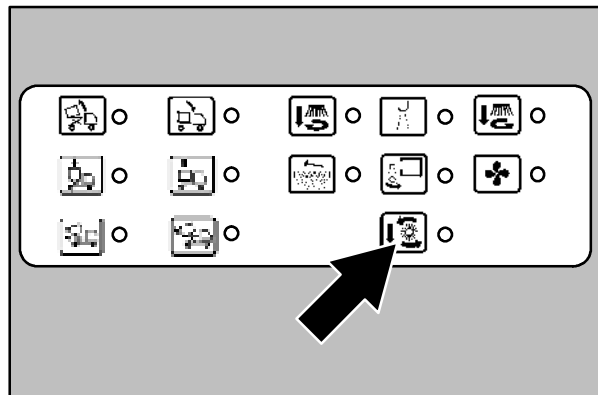

351926

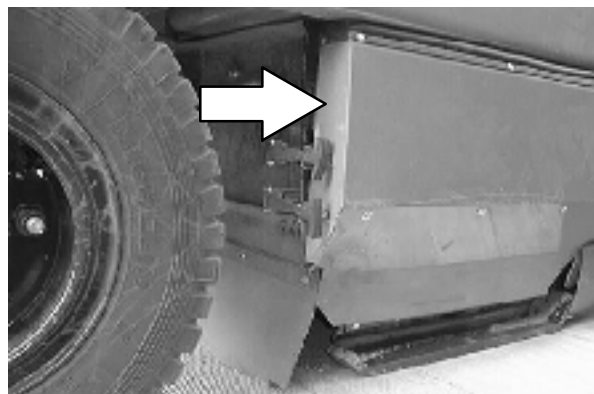

MAINTENANCE

5. Remove the hardware holding the skid plates to the brush idler plate.

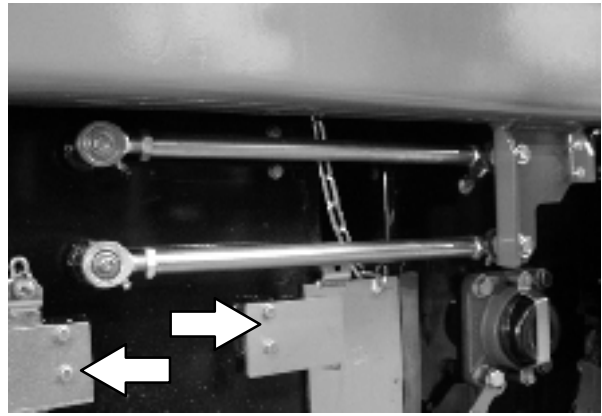

6. Remove the hardware holding the links to the brush idler plate.

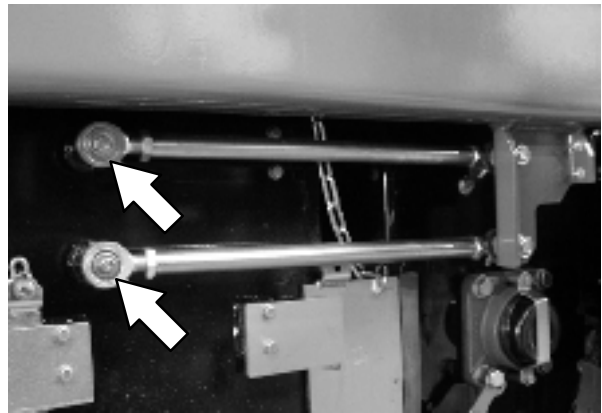

7. Remove the brush chains and the skid chain.

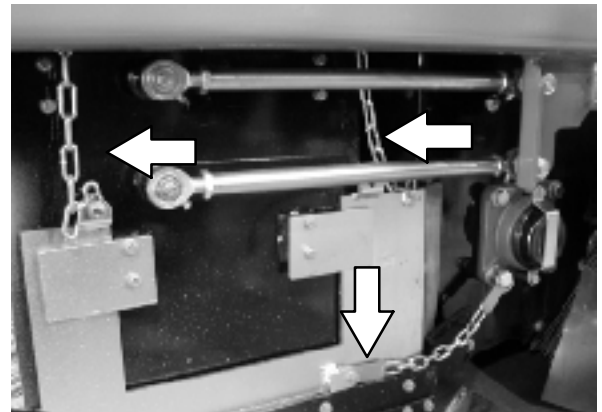

8. Remove the hardware holding the idler plate onto the machine.
9. Remove the brush idler plate.
10. Grasp the main brush; pull it off the brush drive plug and out of the main brush compartment.
11. Put the new brush on the ground next to the access door.
12. Slide the main brush onto the drive plug. Rotate the brush until it engages the drive plug, and push it all the way onto the plug.
13. Slide the main brush idler plate plug onto the main brush.
14. Mount the idler plate onto the machine with the hardware removed earlier.
15. Mount the brush chains and the skid chain.
16. Mount the links to the idler plate with the hardware removed earlier.
17. Mount the skid plates to the idler plate with the hardware removed earlier.
18. Put the right side main brush access door back on the machine.
19. Check and adjust the main brush pattern.

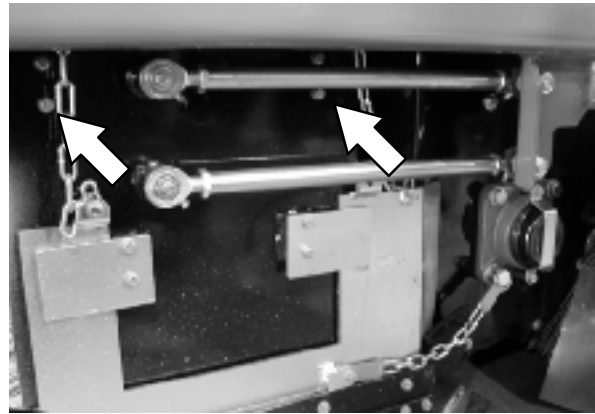

MAINTENANCE

TO CHECK AND ADJUST MAIN BRUSH PATTERN

1. Park the machine on level ground and set the machine parking brake.
2. Press the *sweep switch* to lower and start the main brush. Allow the brush to rotate in one place for 2 minutes.

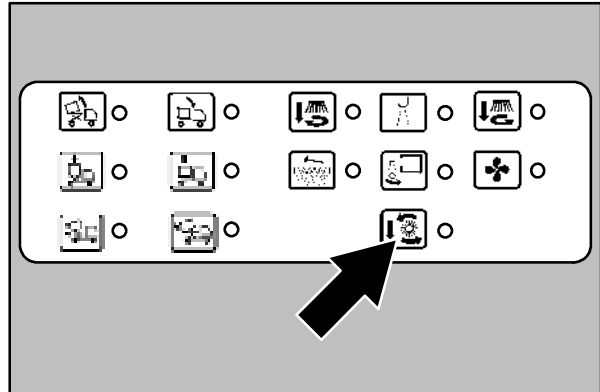

351926

3. Press the *sweep switch* again to raise and stop the main brush.
4. Drive the machine off the test area.
5. Observe the width of the brush pattern. The proper brush pattern width is 100 to 125 mm (4 to 5 in) along the entire length of the brush pattern.
6. To increase the width of the main brush pattern, turn the main brush down pressure nut counter-clockwise.

To decrease the width of the main brush pattern, turn the main brush down pressure nut clockwise.

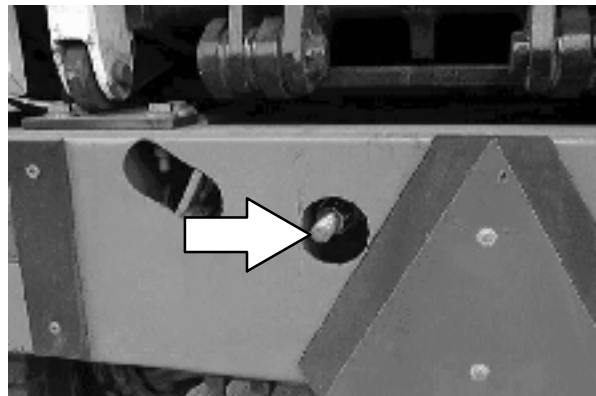

SIDE BRUSH

The side brush sweeps debris along edges into the path of the main brush.

Check the brush daily for wear or damage. Remove any string or wire found tangled on the side brush or side brush drive hub.

The side brush pattern is set at the factory.

Replace the brush when it no longer cleans effectively.

TO REPLACE SIDE BRUSH

1. Raise and stop the side brush.
2. Stop the engine and set the machine parking brake.

FOR SAFETY: Before leaving or servicing machine, stop on level surface, set parking brake, turn off machine and remove key.

3. Remove the dry dust control skirt assembly (option) if equipped.
4. Remove the side brush retaining hardware holding the brush to the drive hub.

⚠ WARNING: Side brush can move. Do not step on side brush.

5. Mount the new side brush to the drive hub with the hardware removed earlier.
6. Check the sidebrush linkage for wear and loose hardware.

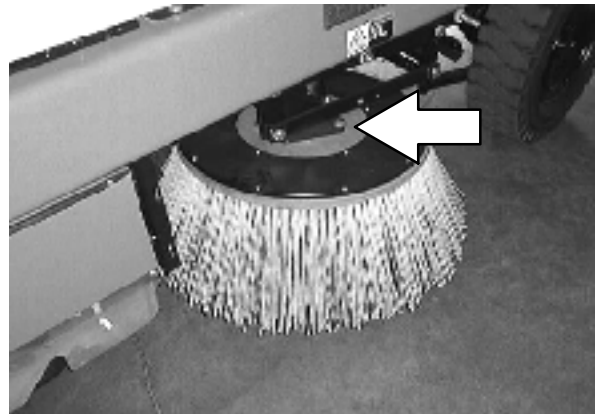

SKIRTS AND SEALS

BRUSH ACCESS DOOR SKIRTS

The brush access door skirts are located on the bottom and front of each of the two main brush access doors. The bottom skirts should touch the skid plates on either side of the machine.

Check the skirts for wear or damage daily.

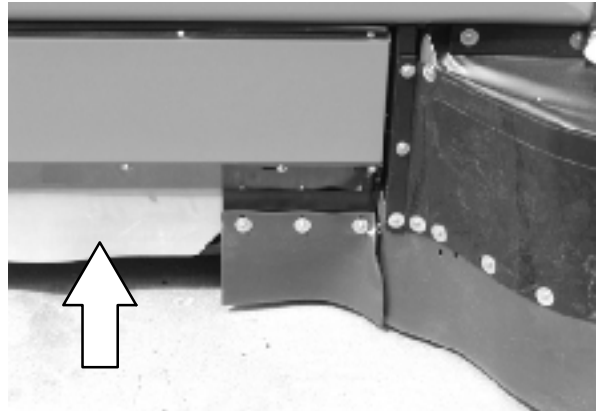

DRY DUST CONTROL SKIRTS (OPTION)

The dry dust control skirts (option) are mounted over the side brushes on each side of the machine. The skirts should clear the ground by less than 3 mm (0.125 in).

Check the skirts for wear or damage daily.

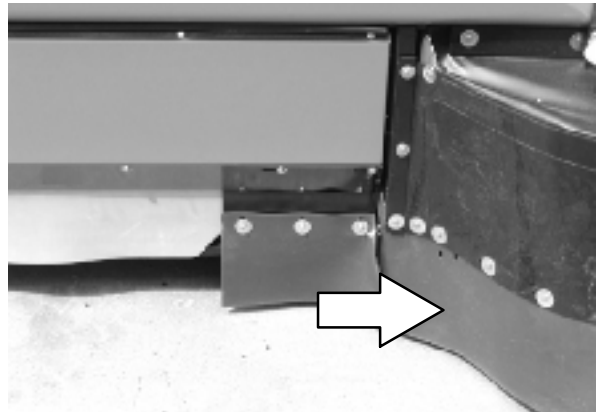

BRUSH COMPARTMENT REAR SKIRT

The brush compartment skirt is located at the rear of the brush compartment. The skirt should clear the ground by 3 mm (0.125 in).

Check the skirt for wear or damage daily.

NOTE: Tire pressure and a full hopper will affect skirt clearances.

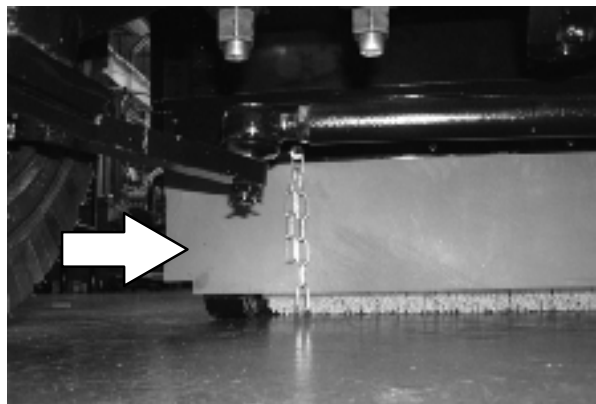

CONVEYOR SKIRTS

The conveyor has a lip skirt located at the bottom rear of the conveyor and two side skirts. The skirts should touch the ground when the conveyor is lowered into the sweeping position.

Check the skirts for wear or damage daily.

Replace the skirts when they no longer touch the ground.

NOTE: Tire pressure and a full hopper will affect skirt clearances.

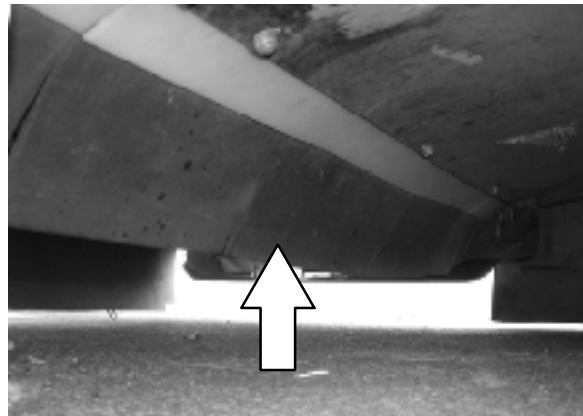

DOOR SEALS

The brush access doors have seals located along their door edges.

Check the seals for wear or damage every 100 hours of operation.

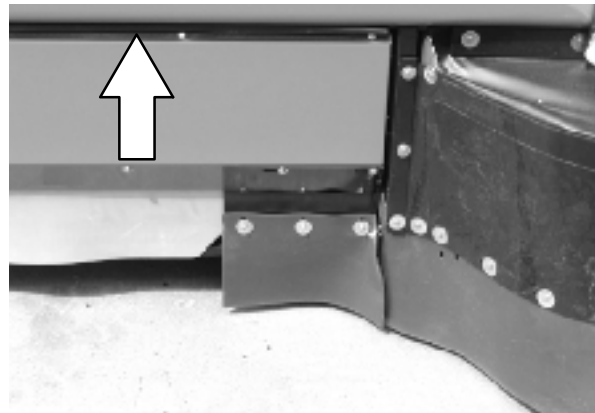

The cab doors have seals located along their door edges.

Check the seals for wear or damage every 100 hours of operation.

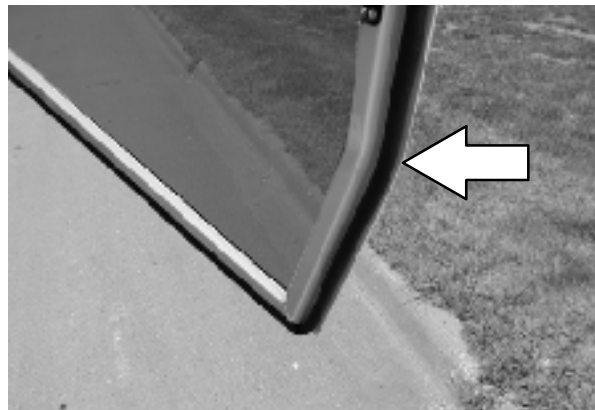

MAINTENANCE

CONVEYOR SEALS

The conveyor seals are located on the machine frame where the conveyor makes contact with the frame.

Check the seals for wear or damage every 100 hours of operation.

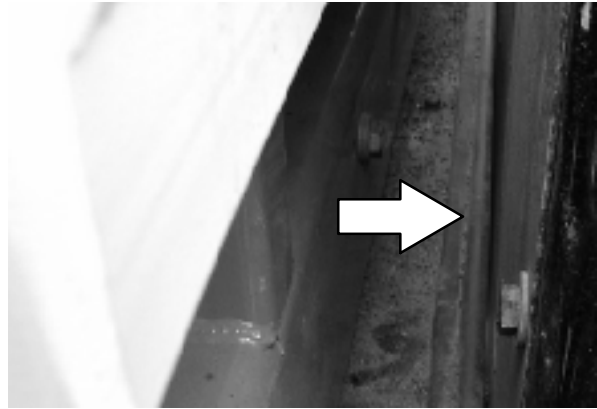

HOPPER SEALS

The hopper seals are located on the hopper door, the hopper filter cover, the dust filter, and the front opening of the hopper.

Check the seals for wear or damage every 100 hours of operation.

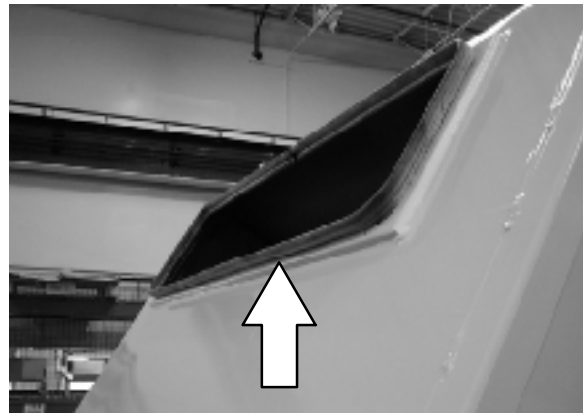

SKIDS

SKIDS

The skids are located on either side of the brush compartment. They skim the ground when the conveyor is lowered into the sweeping position and are designed to contain debris between the main brush and the conveyor lip.

Check the skids for wear after every 100 hours of operation. The skids should be replaced when the thickness is less than 1 mm (0.04 in).

The skids are attached to the upper plate by means of a rubber gusset that absorbs shock. Check the rubber gussets every 100 hours of operation for damage or wear.

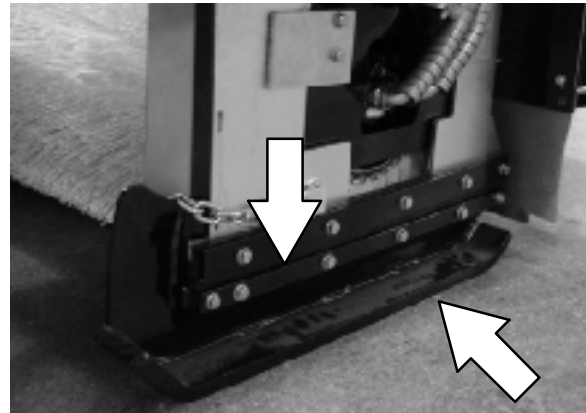

BRAKES AND TIRES

SERVICE BRAKES

This machine is equipped with wet multi-disc service brakes located on all four wheels. These brakes are filled with universal tractor fluid (Mobil 424). The fill/check ports are located on the side of the wheel hubs. The drain ports are located on the bottom of the wheel hubs. The fluid level should be checked after every 400 hours of operation. Change the fluid after every 1600 hours of operation.

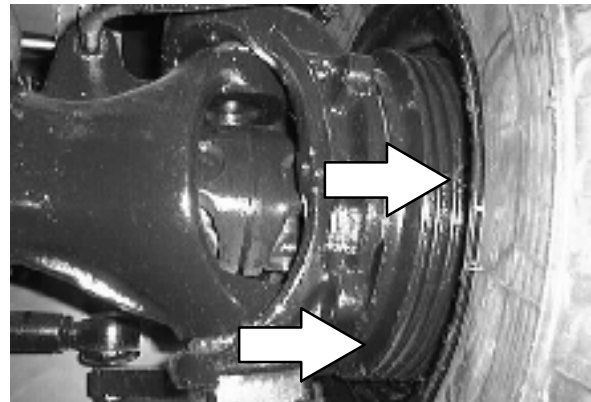

PARKING BRAKE

The parking brake is set with the *parking brake switch*. The dry multi-disk brake unit is located between the differential and the propelling motor.

MAINTENANCE

TIRES

The machine tires are pneumatic. The wheels consist of a 3-piece rim, flap, tube and tire.

Check the tire pressure every 50 hours of operation. The proper tire air pressure is:

bias ply tire	930-1000 kPa (135-145 psi)
radial tire	930-1000 kPa (135-145 psi)

NOTE: The machine is equipped with 3-piece rims. If the tire pressure falls below 550 kPa (80 psi), the tire and wheel assembly should be brought to an industrial tire service center for repair and/or refilling.

Check the tires for wear and rotate every 200 hours of operation.



WHEEL ALIGNMENT

When the machine has been used for some time, a number of things can cause the steering system from tracking properly. Large temperature swings, continual turning in only one direction and cylinder leakage. The front axle is equipped with a hydraulic valve for aligning the wheels. This should be done after every 50 hours of operation or when the machine is not tracking properly.

To align the wheels, start the machine and while moving slowly forward, turn the steering wheel fully right. Stop and apply the parking brake. Find the red valve handle and place it on the steering valve located on the front axle. Open the valve by turning the handle 90° in the counter-clockwise direction. Release the parking brake and while slowly moving forward turn the steering wheel full left then full right. Stop, set the parking brake and close the valve by turning the handle 90° in the clockwise direction.

NOTE: It is important for the machine to be moving while turning so that there is no wind up on the side wall of the tires.

Remove the red valve handle and store for future use. Drive the machine straight forward 100-200 ft before turning. This will settle the system.

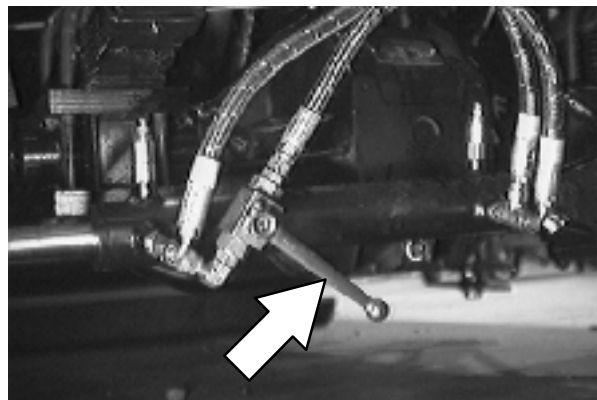

WHEEL NUTS

Check the wheel nut torque on the four wheels every 100 hours of operation. The proper torque is 260 - 305 Nm (190 - 225 ft lb).

PUSHING, TOWING, AND TRANSPORTING THE MACHINE

PUSHING OR TOWING THE MACHINE

If the machine becomes disabled, it can be pushed from the rear or pulled from the front.

The propelling pump has bypass valves to prevent damage to the hydraulic system when the machine is being pushed or towed. **The ignition switch must be turned to the on position to release the parking brake before pushing or towing.** DO NOT exceed 1.6 kmh (1 mph) or 30 meters (100 feet) in distance when moving the machine. The bypass feature is to be used in case of machine breakdown. DO NOT move the machine for any great distance or damage will occur to the propel pump even though the bypass valves are engaged.

ATTENTION! Do not push or tow machine for a long distance and without using the bypass valve, or the machine hydraulic system may be damaged.

Loosen the nuts on the by-pass valves with a 13 mm wrench. Turn in the set screws with a 4 mm allen wrench *until they are below the surface of the nut.* Tighten the nuts.

When finished pushing or towing, loosen the nuts on the bypass valves with a 13 mm wrench. Turn out the set screws with a 4 mm allen wrench until they top out. Tighten the nuts.

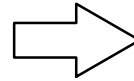
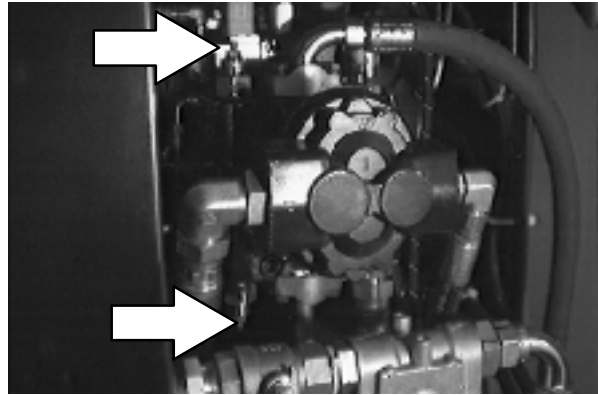

TRANSPORTING THE MACHINE

1. Position the front of the machine at the loading edge of the truck or trailer.

FOR SAFETY: Use truck or trailer that will support the weight of the machine.

NOTE: Empty the hopper and water tank before transporting the machine.

2. If the loading surface is not horizontal or is higher than 380 mm (15 in) from the ground, use a winch to load machine.

If the loading surface is horizontal AND is 380 mm (15 in) or less from the ground, the machine may be driven onto the truck or trailer.

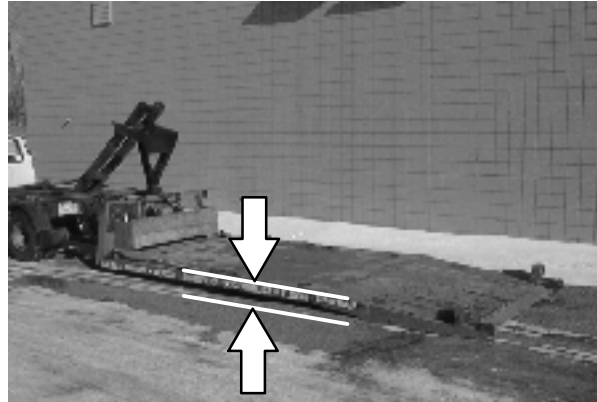

3. To winch the machine onto the truck or trailer, attach the winching chains into the front channel of the machine frame.

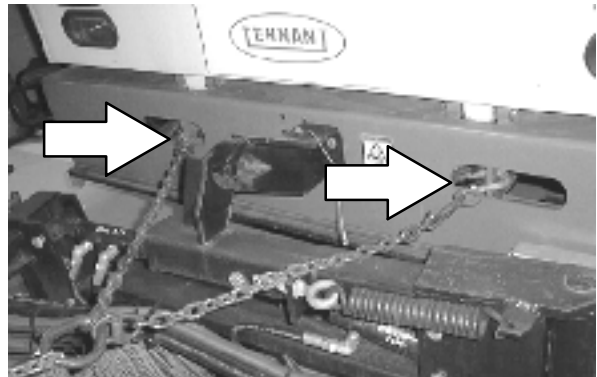

4. Open the bypass valves before winching the machine onto the truck or trailer. See *PUSHING OR TOWING THE MACHINE* section of this manual. Make sure the machine is centered.

FOR SAFETY: When loading machine onto truck or trailer, use winch. Do not drive the machine onto the truck or trailer unless the loading surface is horizontal AND is 380 mm (15 in) or less from the ground.

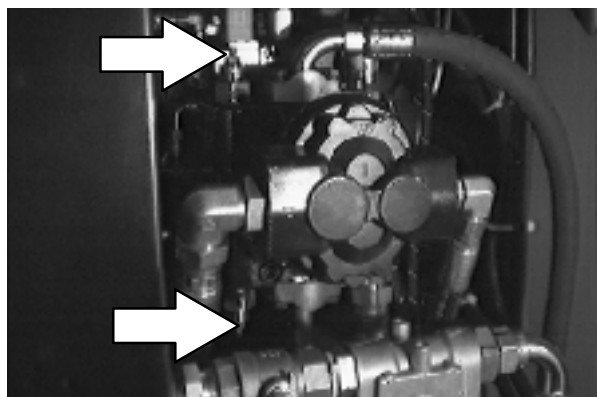

5. Position the machine onto the truck or trailer as far as possible. If the machine starts to veer off the centerline of the truck or trailer, stop and turn the steering wheel to center the machine.

- Set the parking brake and block the machine tires. Tie down the machine to the truck or trailer before transporting.

The front tie-down locations are on the inside channels of the main frame.

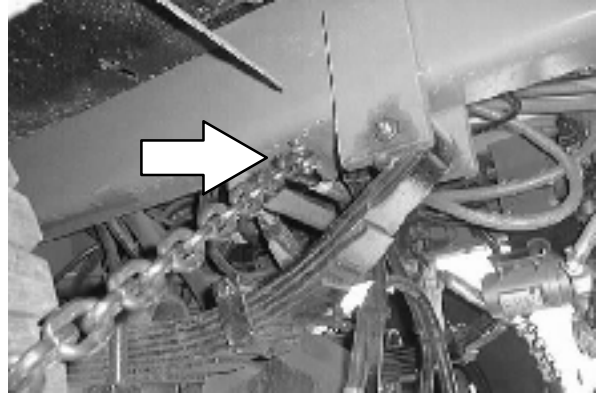

The rear tie-down locations are through the rear channels of the main frame.

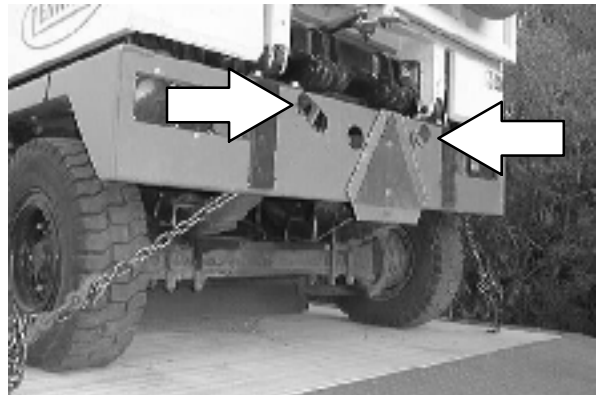

- If the loading surface is not horizontal or is higher than 380 mm (15 in) from the ground, use a winch to unload machine.

If the loading surface is horizontal AND is 380 mm (15 in) or less from the ground, the machine may be driven off the truck or trailer.

FOR SAFETY: When unloading machine off truck or trailer, use winch. Do not drive the machine off the truck or trailer unless the loading surface is horizontal AND 380 mm (15 in) or less from the ground.

MACHINE JACKING

You can jack up the machine for service at the designated locations. Use a Hoist or jack that will support the weight of the machine; a 4-ton jack for empty hopper, and a 6-ton jack with full hopper. It is best to empty the hopper and water tank before jacking the machine.

Always stop the machine on a flat, level surface and block the tires before jacking up the machine.

The front jacking locations are the front axle.

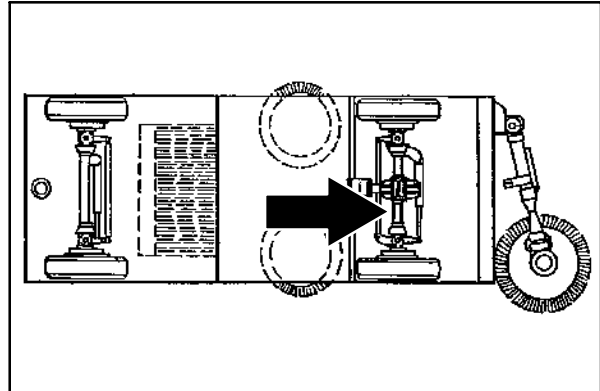

351930

The rear jacking locations are the rear axle.

FOR SAFETY: When servicing machine, block machine tires before jacking machine up.

FOR SAFETY: When servicing machine, jack machine up at designated locations only. Block machine up with jack stands.

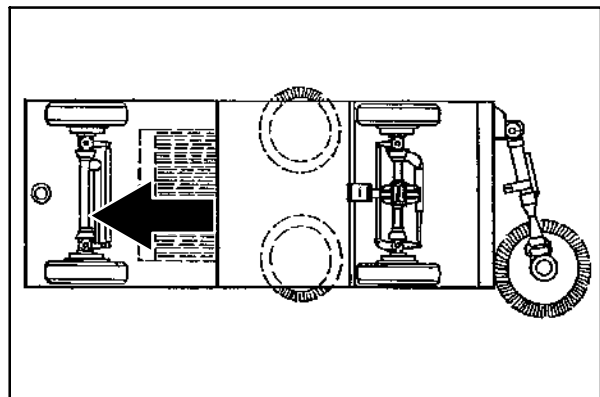

351930

STORING MACHINE

Before storing the machine for an extended period of time, the machine needs to be prepped to lessen the chance of rust, sludge, and other undesirable deposits from forming. Contact TENNANT service personnel.

FREEZE PROTECTION FOR WET DUST CONTROL SYSTEM

1. Open the water valve knobs on the dash panel to drain the lines.
2. Drain the water tank with the drain valve located under the tank.
3. Drain the water lines and pump by opening the drain valve at the water pump under the cab.
4. Remove the water filter cap, located next to the water pump, and empty it.
5. Leave the valves open if the machine is to be stored, or not used for an extended period.

FREEZE PROTECTION FOR THE HIGH PRESSURE WASHER OPTION

1. Flush the pump with a 50/50 mixture of antifreeze and water before winter storage.

SPECIFICATIONS

SPECIFICATIONS

GENERAL MACHINE DIMENSIONS/CAPACITIES

Item	Dimension/capacity
Length	4445 mm (175 in)
Length with vario brush and vac wand options	5460 mm (215 in)
Width	1780mm (70 in)
Height with hazard light	2540 mm (100 in)
Track	1510 mm (59.5 in)
Wheelbase	2970 mm (117 in)
Main brush diameter	610 mm (24 in)
Main brush length	1295 mm (51 in)
Side brush diameter	810 mm (32 in)
Vario Sweeping Brush diameter	965 mm (38 in)
Sweeping path width, main brush only	1295 mm (51 in)
Sweeping path width, main brush and right side brush	1750 mm (69 in)
Sweeping path width, main brush and two side brushes	2210 mm (87 in)
Sweeping path width, main brush, two side brushes, and front Vario Sweeping Brush	3200 mm (126 in)
Main brush pattern width	100 to 125 mm (4 to 5 in)
Hopper weight capacity, Low dump model	3175 kg (7000 lb)
Hopper weight capacity, High dump model	1815 kg (4000 lb)
Hopper volume capacity	2605 L (92ft ³)
Dust filter area	20 m ² (211 sq ft)
Wet dust control water tank (option)	356L (94 gal)
GVWR	9072 kg (20,000 lb)
Axle rating (front and rear)	5000 kg (11,000 lb)
Ceiling height minimum dumping clearance, low dump model	3045 mm (120 in)
Ceiling height minimum dumping clearance, high dump model	5060 mm (199 in)
Hopper dump height (low dump)	1016 mm (40.0 in)
Hopper dump height (high dump)	2895 mm (114 in)
Vibration level at steering wheel does not exceed	2.5 m/s ²
Vibration level at operator seat does not exceed	0.5 m/s ²

GENERAL MACHINE PERFORMANCE

Item	Measure
Maximum forward speed	40.2 kmh (25 mph)
Maximum reverse speed	19.3 kmh (12 mph)
Minimum steering diameter	7.92 m (26 ft)
Minimum turning radius	3.96 m (13 ft)
Maximum rated climb and descent angle	11° (20%)

HYDRAULIC SYSTEM

System	Capacity	Fluid Type
Hydraulic reservoir	68.2 L (18 gal)	ISO Grade 32 - below 7° C (45° F)
Hydraulic total	121 L (32 gal)	ISO Grade 68 (Synthetic) - all temperatures

POWER TYPE (S/N 000000-008499)

Engine	Type	Ignition	Cycle	Aspiration	Cylinders	Bore	Stroke
CAT 3054C	Piston	Diesel	4	Natural (Turbo)	4	105 mm (4.13 in)	127 mm (5.00 in)
	Displacement		Net power, governed		Net power, maximum		
	4.41 L (269 cu in) - (Naturally aspirated)		56 kw (75 hp) @ 2200 rpm (Naturally aspirated)		60 kw (83 hp) @ 2400 rpm (Naturally aspirated)		
	4.41 L (269 cu in) - (Turbo)		89 kw (119 hp) @ 2200 rpm - (Turbo)		95 kw (127 hp) @ 2400 rpm - (Turbo)		
	Fuel		Cooling system		Electrical system		
	Diesel Fuel tank: 90.9 L (24 gal)		Water/ethylene glycol antifreeze w/conditioner		12 V nominal		
			Total capacity: Naturally aspirated 17.8 L (4.7 gal) Turbo 15.52 L (4.1 gal)		130 A alternator		
			Radiator capacity: 5.68 L (1.5 gal)		12V Battery - 1000 cca		
	Idle speed, no load		Governed speed, no load				
	850-900 rpm		Naturally aspirated 2450-2500 rpm Turbo 2250-2350 rpm				
	Engine lubricating oil with filter						
	Naturally aspirated and Turbo: 7.9 L (8.3 qt) w/o filter 10.9 L (11.5 qt) w/filter, Naturally aspirated: API diesel classification CG4 or better Turbo: API diesel classification CG4 or better						
	Air conditioner						
	Refrigerant R134a - total system capacity, 1.9 kg (4 lb)						
PAG - Refrigerant oil, 59.148 ml (2 oz.)							

SPECIFICATIONS

POWER TYPE (S/N 008500-)

Engine	Type	Ignition	Cycle	Aspiration	Cylinders	Bore	Stroke
CAT C4.4L	Piston	Diesel	4	Turbo	4	105 mm (4.13 in)	127 mm (5.00 in)
Displacement		Net power, governed			Net power, maximum		
4.4 L (269 cu in) - (Turbo)		73 kw (91 hp) @ 1800 rpm - (Turbo)			74 kw (99 hp) @ 2200 rpm - (Turbo)		
Fuel		Cooling system			Electrical system		
Diesel Fuel tank: 90.9 L (24 gal)		Water/ethylene glycol antifreeze w/conditioner			12 V nominal		
		Total capacity: Turbo 15.52 L (4.1 gal)			120 A alternator		
		Radiator capacity: 5.68 L (1.5 gal)			12V Battery - 1000 cca		
Idle speed, no load		Governed speed, no load					
850-900 rpm		Turbo 2250-2350 rpm					
Engine lubricating oil with filter							
Turbo: 7.9 L (8.3 qt) w/o filter 10.9 L (11.5 qt) w/filter, Turbo: API diesel classification CH4 or better							
Air conditioner							
Refrigerant R134a - total system capacity, 1.9 kg (4 lb)							
PAG - Refrigerant oil, 59.148 ml (2 oz.)							

STEERING

Type	Power source
Front and rear wheels, hydraulic cylinder, steering rod, and rotary valve controlled	Hydraulic accessory pump

BRAKING SYSTEM

Type	Fluid	Operation
Service brakes	Universal tractor fluid (Mobil 424)	Hydraulic activated wet multi-disc on all four wheels
Parking brake	None	Spring activated dry multi-disc on front axle

TIRES

Location	Type	Size	Ply Rating	Pressure
Front and Rear (4)	Bias Ply Pneumatic	7 x 12 in	16	930-1000 kPa (135-145 psi)
Front and Rear (4)	Radial Pneumatic	7 x 12 in	16	930-1000 kPa (135-145 psi)

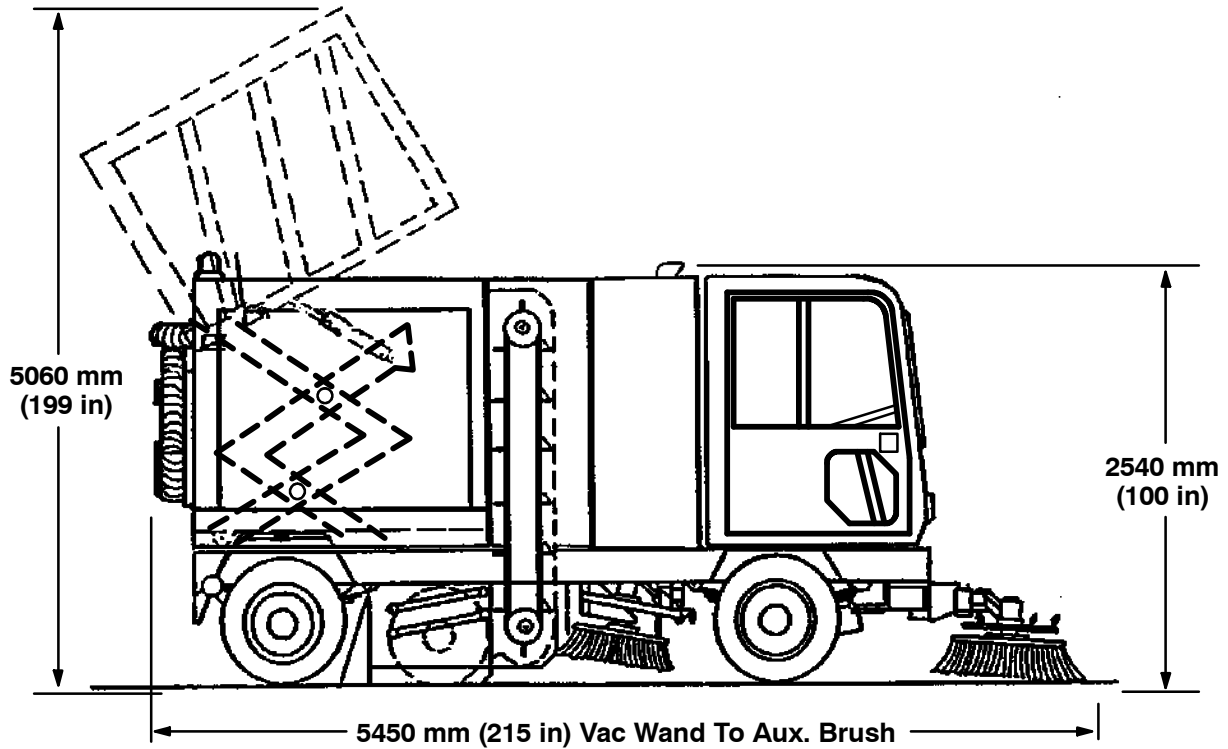

SIDE VIEW

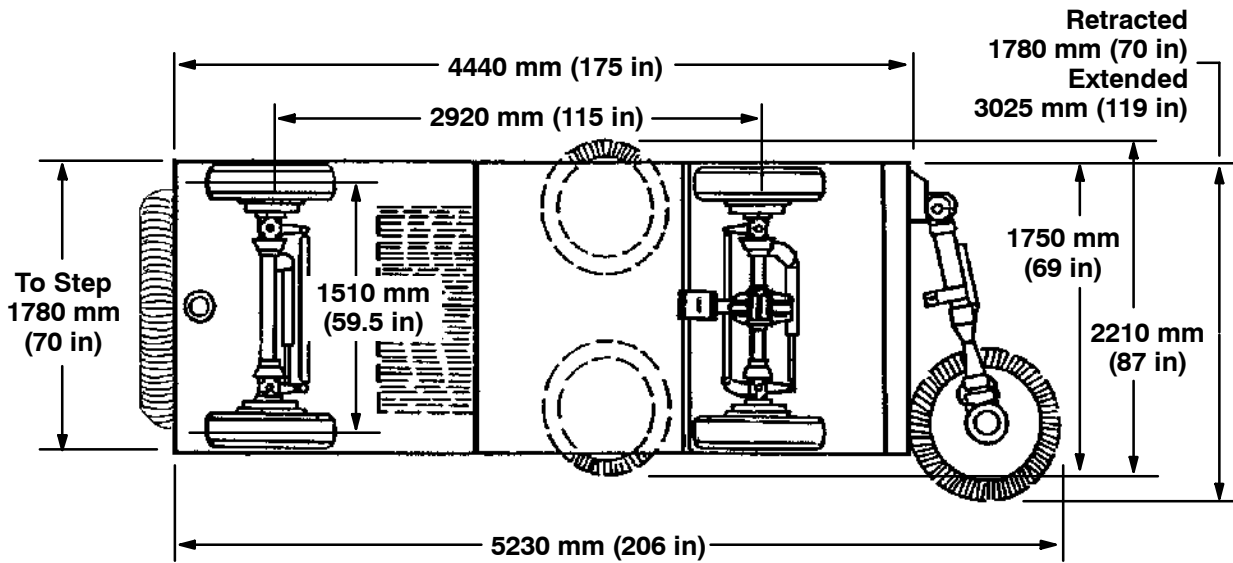

BOTTOM VIEW

MACHINE DIMENSIONS

351930

Numbers

4 way warning lights switch, 43

A

Accessory power socket, 21
Air circulation vents, 28
Air conditioner knob, 28
Air conditioning, Condensor, 101
Air filter, 102
 Dust cap, 102
 Element, 102
 Safety element, 102
Air intake screen, 103
Alarm, Conveyor overload, 58
Axle leaf springs, Lubrication, 92

B

Bar, Hopper support, 48
Battery, 106
 Voltmeter, Light, 35
Belt, Seat, 17
Belts, 107
 Air conditioner belt, 107
 Engine alternator/fan belt, 107
Blades, Windshield wiper, 106
Brackets, Conveyor stop, 55
Brake, Low brake pressure light, 29
Brake pedal, 21
Brakes, 50, 67, 119
 Parking, Adjustment, 119
 Parking brake switch, 30
 Service, 119
 System specifications, 128
Bright headlights light, 25
Brushes, 54–55, 111–116
 Checking main brush pattern, 114
 Checking side brush pattern, 115
 Door latch, 45
 Door skirts, 116
 Main brush, 111–115
 Main brush bristle length, 111
 Maintenance, 50, 67
 Pattern adjustment, 50, 67
 Rear skirt, 116
 Replacing main brush, 111–114
 Replacing side brush, 115
 Side brush, 115
 Side brush bristle length, 115

C

Cab, Filters, 105
Cab Jack, Operation, 82–84
Capacities, 126
Caps
 Engine air filter, 102
 Hydraulic filler, 97
CD player, 45
Chain, Conveyor, 95
Chains, 107
 Conveyor, 110
 Static drag, 107
Charging system, voltmeter, 35
Chart, Maintenance, 89–91
Cigarette, lighter, 21
Clogged engine air filter, 26
Condensor, Air conditioning, 101
Controls, 12–14
 4 way warning lights switch, 43
 Accessory power socket, 21
 Air circulation vents, 28
 Air conditioner knob, 28
 Brake pedal, 21
 Bright headlights light, 25
 Conveyor reverse switch, 41, 58
 Directional lever, 21
 Dome and map light switch, 45
 Engine oil pressure gauge, 34
 Engine shutdown override switch, 30
 Engine water temperature gauge, 34
 Fan knob, 28
 Filter shaker switch, 40
 Front night sweeping light switch, 44
 Fuel level gauge, 34
 Fuse, 33
 Hazard light switch, 43
 Headlights switch, 19
 Heater knob, 27
 High pressure washer switch, 44
 Hopper door close switch, 39
 Hopper door open switch, 39
 Hopper lift switch, 38
 Hopper lower switch, 38
 Hopper overload light, 27
 Hopper tilt back switch, 37
 Hopper tilt forward switch, 37
Horn, 19
Hourmeter, 35
Ignition switch, 20
Incline light, 29
Latches, 45
Left side brush switch, 40
Left side brush water valve knob, 31
Low brake pressure light, 29

Odometer, 35
 Operation, 17
 Parking brake light, 25
 Parking brake switch, 30
 Parking, headlights, signal lights, and horn switch, 19
 Propelling pedal, 20
 Radio and CD player, 45
 Rear night sweeping light switch, 44
 Right side brush switch, 40
 Right side brush water valve knob, 32
 Seat belt, 17
 Side brush spot light(s) switch, 43
 Signal light, 25
 Speedometer, 35
 Steering wheel, 18
 Steering wheel tilt lever (For machines serial number 007053 and below), 18
 Steering wheel tilt lever (For machines serial number 007054 and above), 18
 Sweep switch, 42
 Switch panel, 37
 Symbols, 10–12
 Tachometer, 36
 Throttle lever, 22
 Traffic advisor signal light, 46
 Traffic advisor signal light function knob, 46
 Vacuum fan switch, 41
 Vacuum wand door light, 27
 Vairo sweeping brush lock pin, 22
 Vario sweeping brush joystick, 23
 Vario sweeping brush left water valve knob, 31
 Vario sweeping brush on-off switch, 24
 Vario sweeping brush raise-lower switch, 24
 Vario sweeping brush right water valve knob, 32
 Vario sweeping brush tilt/arm switch, 22
 Voltmeter, 35
 Water pump switch, 39
 Water tank low light, 26
 Windshield wiper and washer switch, 19
 Conveyor, 110
 Bearings, Lubrication, 94
 Chain, Lubrication, 95
 Chains, 110
 Cleaning, 110
 Overload alarm, 58
 Paddles, 110
 Seals, 118
 Skirts, 110, 117
 Conveyor overload alarm, 58
 Conveyor reverse switch, 41, 58
 Conveyor stop brackets, 55
 Cylinder, Steering, Lubrication, 93

D

Debris, Conveyor reverse switch, 58
 Debris hopper, 108–110
 Differential, Lubrication, 96
 Dimensions, 126
 Dimensions, Machine, 129
 Directional lever, 21
 Disengaging hopper support bar, 73–75
 Disengaging hopper support pin, 70–71
 Dome and map light switch, 45
 Doors
 Brush
 Latch, 45
 Skirts, 116
 Cab, Latch, 45
 Seals, 117
 Side, Latch, 45
 Dry dust control (option), Skirts, 116
 Dust Control, Wet
 Left side water valve, 31
 Right side water valve, 32
 Dust control, Wet
 Filter, 105
 Operation, 77–79
 Pump switch, 39
 Dust filter, 108
 Changing, 108–110
 Cleaning, 108–110

E

Electrical
 Battery, 106
 Fuse, 33
 Ignition switch, 20
 Emptying the hopper, 61–63
 Engaging hopper support bar, 71–73
 Engaging hopper support pin, 68–70
 Engine, 101
 Air conditioner belt, 107
 Air filter, 50, 67, 102
 Air filter dust cap, 102
 Air filter element, 102
 Air filter intake screen, 103
 Alternator/fan belt, 107
 Clogged air filter light, 26
 Coolant level, 50, 67
 Cooling system, 101
 Engine shutdown override switch, 30
 engine valve, 104
 Fuel filter, 103

Fuel level, 50, 67
Fuel lines, 104
Fuel water separator, 103
Lubrication, 95
Oil, 95
Oil capacity, 95
Oil level, 50, 67
Oil pressure gauge, Light, 34
Specifications, 127, 128
Tachometer, 36
Water temperature gauge, Gauge, 34
Engine oil pressure gauge, 34
Engine shutdown override switch, 30
Engine water temperature gauge, 34

F

Fan knob, 28
Filter, Clogged engine air, 26
Filter shaker switch, 40
Filters
 Cab, 105
 Hydraulic, 97
 Reservoir, hydraulic, 98
 Wet dust control, 105
Freeze protection
 pressure washer, 125
 Wet dust control, 125
Front night sweeping light switch, 44
Fuel, Level gauge, 34
Fuel filter, 103
Fuel level gauge, 34
Fuel lines, 104
Fuel system, Fuel lines, 104
Fuel water separator, 103
Fuse, 33

G

Gauges
 Engine oil pressure, 34
 Engine water temperature, 34
 Fuel level, 34
 Hourmeter, 35
 Hydraulic filter, 98
 Odometer, 35
 Speedometer, 35
 Tachometer, 36
 Voltmeter, 35
Glow plugs light, 26
GVWR, 8, 54, 126

H

Hazard light switch, 43
Heater knob, 27
High pressure washer switch, 44
Hopper, 108–110
 Changing dust filter, 108–110
 Cleaning dust filter, 108–110
 Disengaging hopper support bar, 73–75
 Disengaging hopper support pin, 70–71
 Door close switch, 39
 Door open switch, 39
 Dust filter, 108
 Engaging hopper support bar, 71–73
 Engaging hopper support pin, 68–70
 Filter cleaning, 108
 Filter shaker switch, 40
 Incline light, 29
 Lift switch, 38
 Lower switch, 38
 Overload light, 27
 Seals, 118
 Support bar, 48
 Support pin, 47
 Thermo-Sentry, 109
 Tilt back switch, 37
 Tilt forward switch, 37
Hopper door close switch, 39
Hopper door open switch, 39
Hopper lift switch, 38
Hopper lift/tilt (high dump), Lubrication, 92
Hopper lower switch, 38
Hopper overload light, 27
Hopper support bar, 48
Hopper support pin, 47
Hopper Tilt, Lubrication, 92
Hopper tilt back switch, 37
Hopper tilt forward switch, 37
Horn, 19
Hoses, Hydraulic, 100
Hourmeter, 35
How the machine works, 49
Hydraulic cooler, Fins, 50, 67
Hydraulic fluid, 99
Hydraulic fluid reservoir, 97
Hydraulic fluid reservoir filter, 98
Hydraulic fluid reservoir filter gauge, 98
Hydraulic hoses, 100

Hydraulics, 97–99

- Cooler, 101
- Filler cap, 97
- Filters, 97
- Fluid, 99
- Fluid filter guage, 98
- Fluid level, 50, 67, 97
- Hoses, 100
- Purging air from the hydraulic lift system, 100
- Reservoir, 97
- Reservoir filter, 98
- System specifications, 127

I

Ignition switch, 20

Incline light, 29, 74

Inclines, Operating on, 74

J

Jack points, 124

Joystick, 8

Joystick, Vario sweeping brush, 23

K

Knobs

- Air conditioner, 28
- Fan, 28
- Heater, 27
- Left side brush water valve, 31
- Right side brush water valve, 32
- Vario sweeping brush left water valve, 31
- Vario sweeping brush right water valve, 32

L

Latches, 45

- Cab doors, 45
- Main brush doors, 45
- Side doors, 45

Left side brush switch, 40

Levers

- Directional, 21
- Steering wheel tilt (For machines serial number 007053 and below), 18
- Steering wheel tilt (For machines serial number 007054 and above), 18
- Throttle, 22

Lighter, cigarett, 21

Lights

- 4 way warning lights, 43
- Bright headlights light, 25
- Clogged engine air filter, 26
- Dome and map light switch, 45
- Front night sweeping light switch, 44
- Glow plugs, 26
- Hazard light switch, 43
- Headlights, 19
- Hopper overload, 27
- Incline, 29
- Low brake pressure, 29
- Parking, 19
- Parking brake light, 25
- Rear night sweeping light switch, 44
- Side brush spot light(s) switch, 43
- Signal, 25
- Signals, 19
- Traffic advisor signal, 46
- Vacuum wand door, 27
- Water tank low, 26

Lock pin, Vairo sweeping brush, 22

Low brake pressure light, 29

Lubrication, 91

- Axle leaf springs, 92
- Conveyor bearings, 94
- Conveyor chain, 95
- Differential, 96
- Engine, 95
- Hopper tilt, 92
- Hopper lift/tilt (high dump), 92
- Main brush support rods, 96
- Side brush pivot, 93
- Steering cylinder, 93
- Vario sweeping brush, 94
- Wheel pivots points, 93

M

Machine components, 9

Machine dimensions, 129

Machine jacking, 124

Machine tie down location, 123

Machine troubleshooting, 86, 87

Main brush, 54, 111–115

- Bristle length, 111
- Checking brush pattern, 114
- Door latch, 45
- Door skirts, 116
- Maintenance, 111
- Replacing, 111–114
- Support rods, 96

Maintenance, 88
 Intervals, 89–91
 Recommended, 8

Maintenance chart, 89–91

O

Odometer, 35
Oil pressure gauge, engine, 34
Operation, 8–60
Operation on inclines, 74
Operator Responsibility, 8
Operator seat, 17
 Seat belt, 17
Options
 Air conditioner belt, 107
 Air conditioner knob, 28
 Cab Jack, Operation, 82–84
 Dry dust control skirts, 116
 Front night sweeping light switch, 44
 High pressure washer switch, 44
 Hopper incline light, 29
 Hopper lift switch, 38
 Hopper lower switch, 38
 Left side brush switch, 40
 Left side brush water valve knob, 31
 Operation, 75–81
 Radio and CD player, 45
 Rear night sweeping light switch, 44
 Right side brush switch, 40
 Right side brush water valve knob, 32
 Tilting the Cab (Manually), Operation, 84–86
 Vacuum wand, Operation, 79–81
 Vacuum wand door light, 27
 Vairo sweeping brush lock pin, 22
 Vairo sweeping brush, 94
 Operation, 75–77
 Vairo sweeping brush joystick, 23
 Vairo sweeping brush left water valve knob, 31
 Vairo sweeping brush on–off switch, 24
 Vairo sweeping brush raise–lower switch, 24
 Vairo sweeping brush right water valve knob, 32
 Vairo sweeping brush tilt/arm switch, 22
 Water pump switch, 39
 Water tank low light, 26
 Wet dust control, Filter, 105
 Wet dust control system, Operation, 77–79

P

Parking brake, 119
 Light, 25
Parking brake light, 25
Parking brake switch, 30
Parking lights, headlights, signal, and horn switch, 19
Pedal, Propelling, 20
Pedals, Brake, 21
Pin, Hopper support pin, 47
Post-operation checklist, 67
Pre-operation checklist, 50–53
Preheat, Glow plugs, 26
Propelling pedal, 20
Purging air from the hydraulic conveyor lift system, 100
Pushing machine, 121
Pushing or towing the machine, 121
Pushing, towing, and transporting machine, 121

R

Radiator
 Coolant level, 101
 Coolant type, 101
 Exterior, 101
 Fins, 50, 67
 Flushing system, 101
 Hoses, 101
Radio, 45
Radio and CD player, 45
Re–phasing the conveyor lift system, 100
Rear night sweeping light switch, 44
Reservoir, hydraulic, 97
Right side brush switch, 40

S

Safety
 4 way warning lights switch, 43
 Disengaging hopper support bar, 73–75
 Disengaging hopper support pin, 70–71
 Engaging hopper support bar, 71–73
 Engaging hopper support pin, 68–70
 Hopper support bar, 48
 Hopper support pin, 47
 Labels, 6
 Precautions, 4
 Vairo sweeping brush lock pin, 22

- Safety element, 102
- Seals, 116–118
 - Conveyor, 118
 - Door, 117
 - Hopper, 118
- Seat, 17
 - Adjustment, 17
- Seat Belt, 17
- Separator, Fuel water, 103
- Service records, 50, 67
- Side brush, 54, 115
 - Bristle length, 115
 - Checking brush pattern, 115
 - Replacing, 115
 - Vario, Lubrication, 94
- Side brush pivot, Lubrication, 93
- Side brush spot light(s) switch, 43
- Side brush switch, left, 40
- Side brush switch, right, 40
- Signal light, 25
- Skids, 119
- Skirts, 116
 - Brush compartment, 116
 - Brush doors, 116
 - Conveyor, 117
 - Dry dust control (option), 116
- Skirts and seals, 50, 67
- Specifications, 126–127
 - Braking system, 128
 - GVWR, 126
 - Hydraulic system, 127
 - Machine capacities, 126
 - Machine dimensions, 126
 - Machine performance, 127
 - Power type, 127, 128
 - Steering, 128
 - Tires, 128
- Speedometer, 35
- Starting the machine, 51–53
- Static drag chain, 107
- Steering, 50, 67
 - Specifications, 128
- Steering cylinder, Lubrication, 93
- Steering wheel, 18
- Steering wheel tilt lever (For machines serial number 007053 and below), 18
- Steering wheel tilt lever (For machines serial number 007054 and above), 18
- Stop sweeping, 59
- Stop the machine, 65–67
- Storing machine, 125
 - Freeze protection, 125
- Sweep switch, 42
- Sweeping, 55–58
- Sweeping and brush information, 54–55
- Switch Panel
 - Conveyor reverse switch, 41
 - Filter shaker switch, 40
 - Hopper door close switch, 39
 - Hopper door open switch, 39
 - Hopper lift switch, 38
 - Hopper lower switch, 38
 - Hopper tilt back switch, 37
 - Hopper tilt forward switch, 37
 - Left side brush switch, 40
 - Right side brush switch, 40
 - Sweep switch, 42
 - Vacuum fan switch, 41
 - Water pump switch, 39
- Switch panel, 37
- Switches
 - 4 way warning lights, 43
 - Conveyor reverse, 41, 58
 - Dome and map light, 45
 - Engine shutdown override switch, 30
 - Filter shaker, 40
 - Front night sweeping light, 44
 - Hazard light, 43
 - Headlights, 19
 - High pressure washer, 44
 - Hopper door close switch, 39
 - Hopper door open switch, 39
 - Hopper lift switch, 38
 - Hopper lower switch, 38
 - Hopper tilt back, 37
 - Hopper tilt forward, 37
 - Horn, 19
 - Ignition, 20
 - Left side brush, 40
 - Parking and signal lights, 19
 - Parking brake, 30
 - Rear night sweeping light, 44
 - Right side brush, 40
 - Side brush spot light(s), 43
 - Sweep, 42
 - Switch panel, 37
 - Traffic advisor signal light, 46
 - Traffic advisor signal light function, 46
 - Vacuum fan, 41
 - Vario sweeping brush on-off, 24
 - Vario sweeping brush raise-lower, 24
 - Vario sweeping brush tilt/arm, 22
 - Water pump, 39
 - Windshield wiper and washer, 19

T

Tachometer, 36
Thermo-sentry, 109
Throttle, Lever, 22
Throttle lever, 22
Tie down location, 123
Tilting the Cab (Manually), Operation, 84–86
Tires, 119–121
 Pressure, 120
 Specifications, 128
Towing machine, 121
Traffic advisor signal light, 46
Traffic advisor signal light function knob, 46
Transporting machine, 121
Transporting the machine, 122
Travel speed, 127
Troubleshooting, 86, 87
Turning radius, 127

V

Vacuum fan switch, 41
Vacuum wand
 Door light, 27
 Operation, 79–81
Vacuum wand door light, 27
Vario sweeping brush
 Joystick, 23
 Left water valve knob, 31
 Lock pin, 22
 Lubrication, 94
 On–off switch, 24
 Operation, 75–77
 Raise–lower switch, 24
 Right water valve knob, 32
 Tilt/arm switch, 22
Vents, Air circulation, 28

W

Washer, High pressure washer switch, 44
Water pump switch, 39
Water separator, Fuel, 103
Water tank low light, 26
Weight limit, 8, 54, 126
Wet dust control filter, Filter, 105
Wet dust control system, Operation, 77–79
Wheel alignment, 120
Wheel nuts, 120
 Torque, 120
Wheel pivots, Lubrication points, 93
Wheels
 Alignment, 120
 Leaf springs, Lubrication, 92
 Nuts, 120
 Pivots points, Lubrication, 93
Windshield washer, 106
Windshield washer and wiper switch, 19
Windshield washer fluid level, 50
Windshield wiper, Blades, 106
Windshield wipers, Switch, 19