

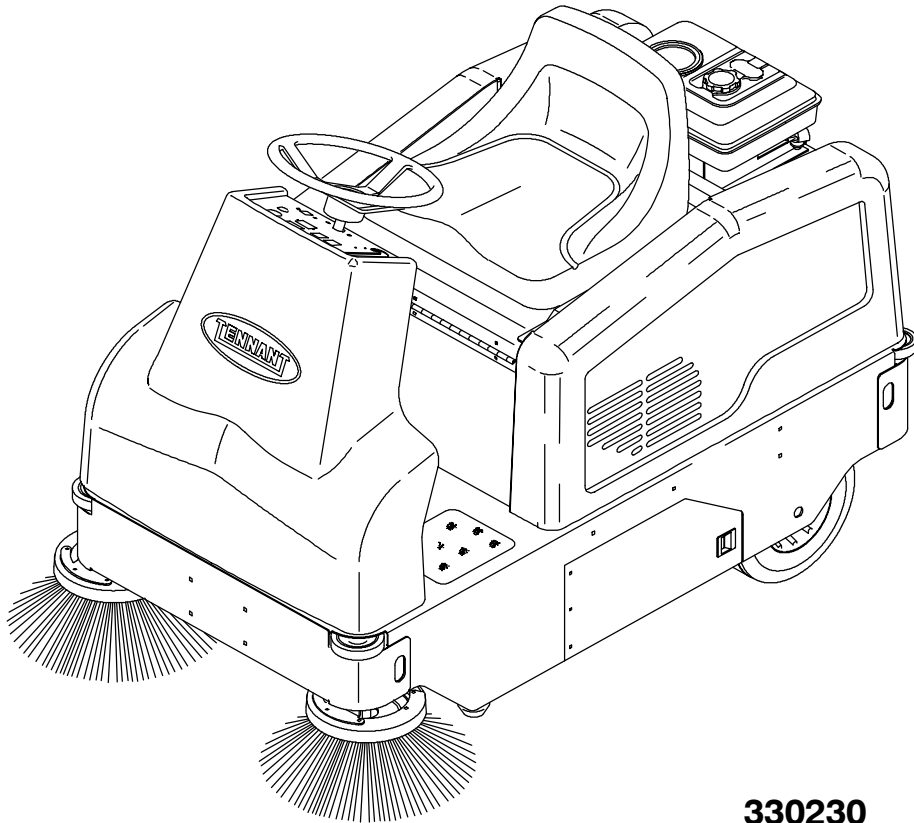

**6100**

**Operator Manual**



**330230**

**Rev. 04**





This manual is furnished with each new TENNANT Model 6100. It provides necessary operating and preventive maintenance instructions. Read this manual completely and understand the machine before operating or servicing it.

This machine will provide excellent service. However, the best results will be obtained at minimum costs if:

- The machine is operated with reasonable care.
- The machine is maintained regularly – per the maintenance instructions provided.
- The machine is maintained with TENNANT supplied or approved parts.

Manual Number - 330230

Revision: 04

Published: 9-02



**CALIFORNIA PROPOSITION 65 WARNING: Engine exhaust from this product contains chemicals known to the State of California to cause cancer, birth defects, or other reproductive harm.**

**CONTENTS**

	Page		Page
SAFETY PRECAUTIONS .....	2	HYDRAULICS .....	40
OPERATION .....	4	HYDRAULIC FLUID RESERVOIR .....	40
OPERATOR RESPONSIBILITY .....	4	HYDRAULIC FLUID .....	41
MACHINE COMPONENTS .....	5	HYDRAULIC HOSES .....	41
SYMBOL DEFINITIONS .....	6	ENGINE .....	42
CONTROLS AND INSTRUMENTS .....	7	AIR FILTER .....	42
OPERATION OF CONTROLS .....	8	FUEL SCREEN .....	43
DIRECTIONAL PEDAL .....	8	FUEL LINES .....	43
BRAKE PEDAL .....	9	CARBURETOR .....	44
PARKING BRAKE PEDAL .....	9	SPARK PLUGS .....	44
LARGE DEBRIS TRAP PEDAL .....	9	BATTERY .....	44
MAIN BRUSH LEVER .....	10	BELTS AND CHAINS .....	45
CHARGING SYSTEM LIGHT .....	10	VACUUM FAN BELT .....	45
ENGINE OIL PRESSURE LIGHT .....	10	MAIN BRUSH BELT .....	45
FUEL LEVEL GAUGE .....	11	HYDRAULIC PUMP BELT .....	46
VACUUM FAN/FILTER SHAKER		JACKSHAFT BELT .....	46
SWITCH .....	12	PROPELLING SYSTEM .....	47
STEERING WHEEL .....	12	STEERING GEAR CHAIN .....	47
HOURMETER .....	12	STATIC DRAG CHAIN .....	47
IGNITION SWITCH .....	13	DEBRIS HOPPER .....	48
HORN BUTTON .....	13	INSTANT ACCESS™ HOPPER FILTER ..	48
SIDE BRUSH LEVER .....	13	REMOVING INSTANT ACCESS™	
OPERATING LIGHTS SWITCH		FILTER .....	49
(OPTION) .....	14	THERMO SENTRY™ .....	53
OPERATING/HAZARD LIGHTS SWITCH		BRUSHES .....	54
(OPTION) .....	14	MAIN BRUSH .....	54
FUSES .....	15	REPLACING MAIN BRUSH .....	54
CIRCUIT BREAKERS .....	15	CHECKING AND ADJUSTING MAIN	
OPERATOR SEAT .....	16	BRUSH PATTERN .....	55
ADJUSTABLE OPERATOR SEAT		SIDE BRUSH .....	57
(OPTION) .....	16	REPLACING SIDE BRUSH .....	58
HOPPER .....	17	SIDE BRUSH GUARD .....	58
HOW THE MACHINE WORKS .....	18	SKIRTS AND SEALS .....	59
PRE-OPERATION CHECKLIST .....	18	REAR SKIRTS .....	59
CHANGING AN LPG FUEL TANK .....	20	SIDE SKIRTS .....	60
STARTING THE MACHINE .....	22	LARGE DEBRIS TRAP SKIRT .....	60
OPERATION ON INCLINES .....	24	HOPPER SEALS .....	60
SWEEPING AND BRUSH INFORMATION	25	BRAKES AND TIRES .....	61
SWEEPING .....	26	PUSHING, TOWING, AND TRANSPORTING	
STOP SWEEPING .....	28	THE MACHINE .....	63
STOPPING THE MACHINE .....	29	PUSHING OR TOWING THE MACHINE	63
EMPTYING THE HOPPER .....	31	TRANSPORTING THE MACHINE ..	63
POST-OPERATION CHECKLIST .....	32	MACHINE JACKING .....	65
OPTIONS .....	33	STORING MACHINE .....	65
QUICK MOP™ .....	33	SPECIFICATIONS .....	66
MACHINE TROUBLESHOOTING .....	35	GENERAL MACHINE PERFORMANCE ..	66
MAINTENANCE .....	36	POWER TYPE .....	67
MAINTENANCE CHART .....	36	STEERING .....	67
LUBRICATION .....	38	HYDRAULIC SYSTEM .....	67
ENGINE .....	38	BRAKING SYSTEM .....	67
PROPELLING SYSTEM .....	38	TIRES .....	67
STEERING GEAR CHAIN .....	39	MACHINE DIMENSIONS .....	68
STEERING CASTOR PIVOT BEARING	39	INDEX .....	69

## SAFETY PRECAUTIONS

The following symbols are used throughout this manual as indicated in their description:



**WARNING:** To warn of hazards or unsafe practices that could result in severe personal injury or death.

**FOR SAFETY:** To identify actions that must be followed for safe operation of equipment.

The machine is suited to sweep disposable debris. Do not use the machine other than described in this Operator Manual. The machine is not designed for use on public roads.

The following information signals potentially dangerous conditions to the operator or equipment:



**WARNING:** Engine emits toxic gases. Severe respiratory damage or asphyxiation can result. Provide adequate ventilation. Consult with your regulatory authorities for exposure limits. Keep engine properly tuned.



**WARNING:** Brush throws debris. Stop motor before lifting hopper.

### FOR SAFETY:

1. **Do not operate machine:**
  - Unless trained and authorized.
  - Unless operation manual is read and understood.
  - In flammable or explosive areas unless designed for use in those areas.
  - In areas with possible falling objects unless equipped with overhead guard.
2. **Before starting machine:**
  - Check for fuel leaks.
  - Keep sparks and open flame away from refueling area.
  - Make sure all safety devices are in place and operate properly.
  - Check brakes and steering for proper operation.
3. **When starting machine:**
  - Keep foot on brake and directional pedal in neutral.
4. **When using machine:**
  - Use brakes to stop machine.
  - Go slowly on inclines and slippery surfaces.
  - Use care when reversing machine.
  - Do not carry riders on machine.
  - Always follow safety and traffic rules.
  - Report machine damage or faulty operation immediately.
5. **Before leaving or servicing machine:**
  - Stop on level surface.
  - Set parking brake.
  - Turn off machine and remove key.
6. **When servicing machine:**
  - Avoid moving parts. Do not wear loose jackets, shirts, or sleeves when working on machine.
  - Block machine tires before jacking up machine.
  - Jack up machine at designated locations only. Block machine up with jack stands.
  - Use hoist or jack that will support the weight of the machine.
  - Wear eye and ear protection if using pressurized air or water.
  - Disconnect battery connections before working on machine.
  - Avoid contact with battery acid.
  - Use cardboard to locate leaking hydraulic fluid under pressure.
  - Use Tennant supplied or equivalent replacement parts.
7. **When loading/unloading machine onto/off truck or trailer:**
  - Turn off machine.
  - Use truck or trailer that will support the weight of the machine.
  - Use winch. Do not drive the machine onto/off the truck or trailer unless the load height is 380 mm (15 in) or less from the ground.
  - Set parking brake after machine is loaded.
  - Block machine tires.
  - Tie machine down to truck or trailer.

The following safety labels are mounted on the machine in the locations indicated. If these or any labels become damaged or illegible, install a new label in its place.

**FOR SAFETY LABEL - LOCATED ON THE SIDE OF THE OPERATOR COMPARTMENT.**



**FLYING DEBRIS LABEL - LOCATED ABOVE HOPPER.**

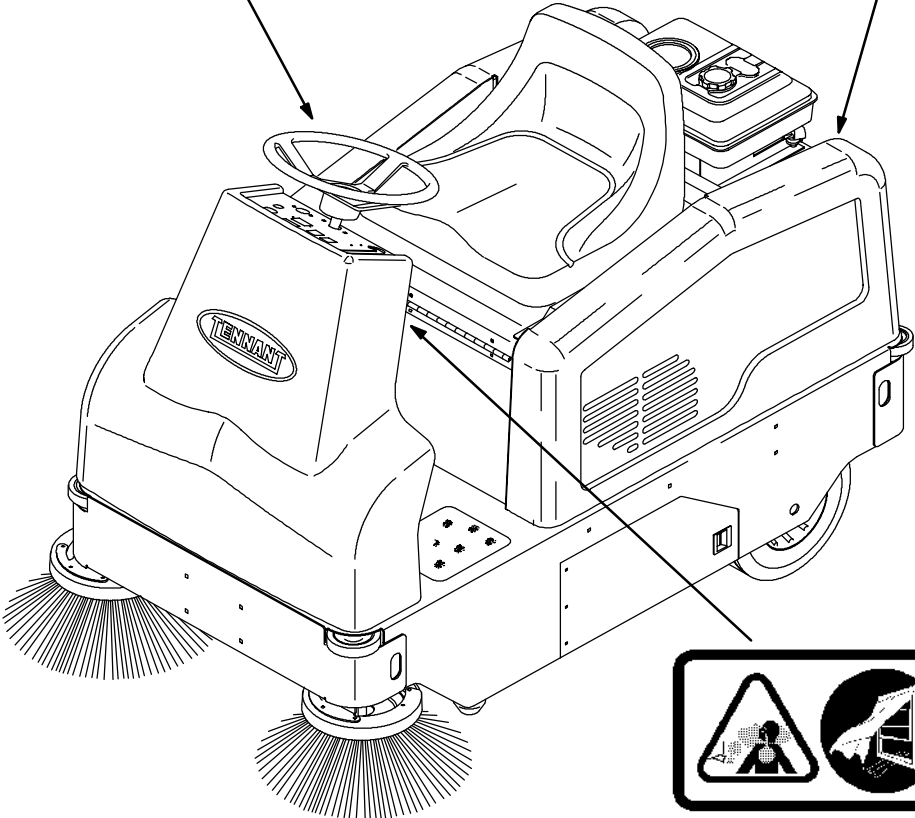

**EMISSIONS LABEL - LOCATED BELOW CONTROL PANEL.**

### OPERATOR RESPONSIBILITY

- The operator's responsibility is to take care of the daily maintenance and checkups of the machine to keep it in good working condition. The operator must inform the service mechanic or supervisor when the maintenance intervals are required as stated in the *MAINTENANCE* section of this manual.

- Read this manual carefully before operating the machine. View the operation video supplied with the machine.

**FOR SAFETY: Do not operate machine, unless operation manual is read and understood.**

- Check the machine for shipping damage. Check to make sure the machine is complete per shipping instructions.
- Keep your machine regularly maintained by following the maintenance information in this manual. We recommend taking advantage of a regularly scheduled service contract from your Tennant representative.
- Order parts and supplies directly from your authorized Tennant representative. Use the parts manual provided when ordering parts.
- After the first 50 hours of operation, follow the recommended daily and hourly procedures stated in the *MAINTENANCE CHART*.

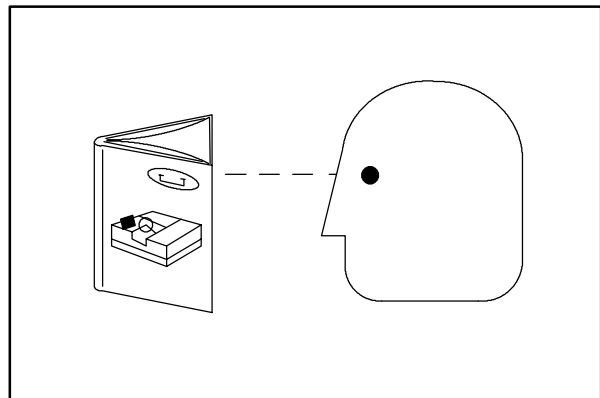

07324

## MACHINE COMPONENTS

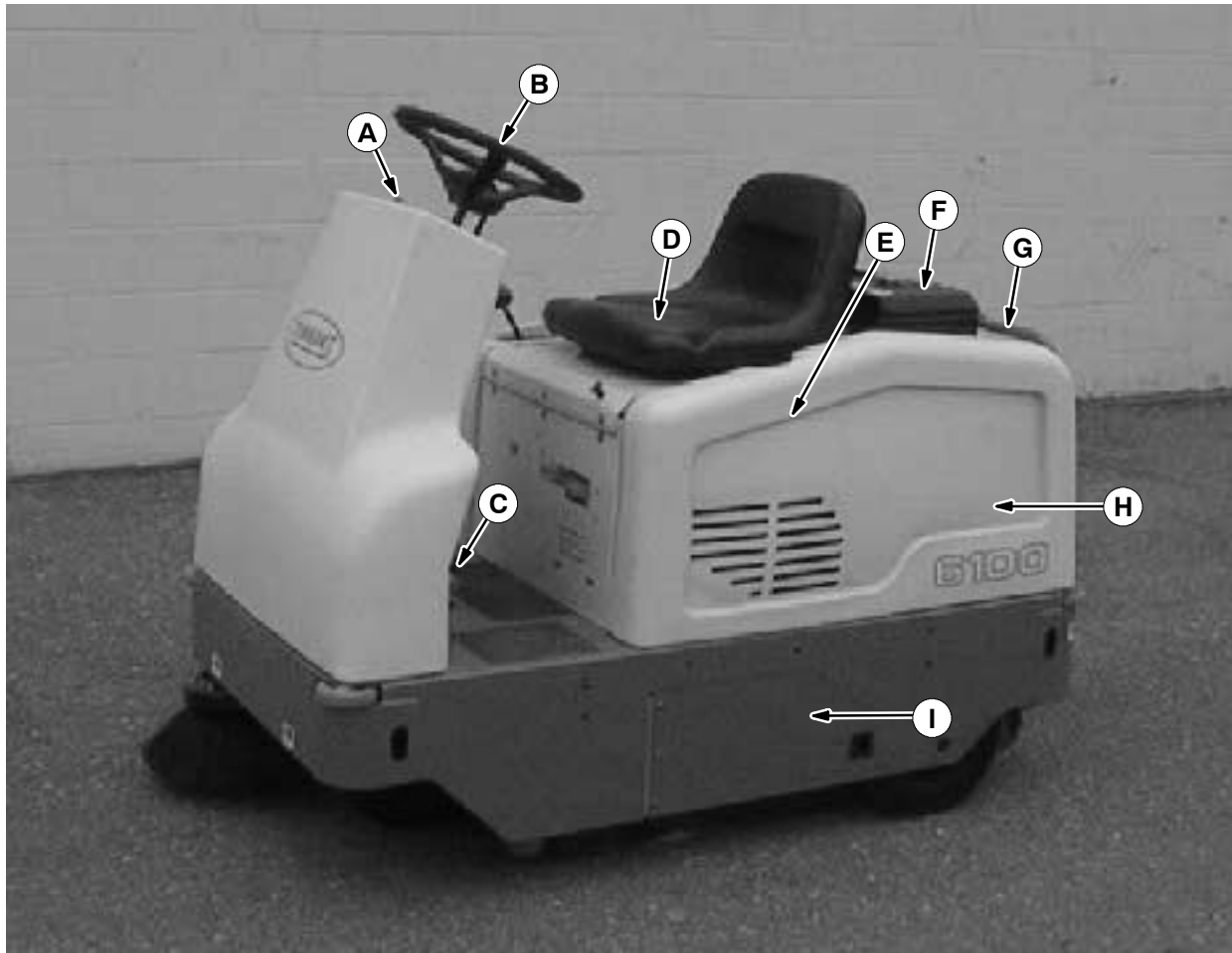

















- A. Instrument panel
- B. Steering wheel
- C. Operator pedals
- D. Operator seat
- E. Engine
- F. Fuel tank
- G. Hopper
- H. Instant Access™ filter
- I. Brush door

# OPERATION

## SYMBOL DEFINITIONS

These symbols identify controls, displays, and features on the machine:

	On		Start
	Off		Operating lights
	Main brush down		Hazard light
	Main brush up		Engine Oil Pressure
	Circuit breaker #1		Battery charging system
	Circuit breaker #2		Filter shaker
	Circuit breaker #3		Side brush down and on
	Horn		Side brush up and off
	Choke		



## CONTROLS AND INSTRUMENTS

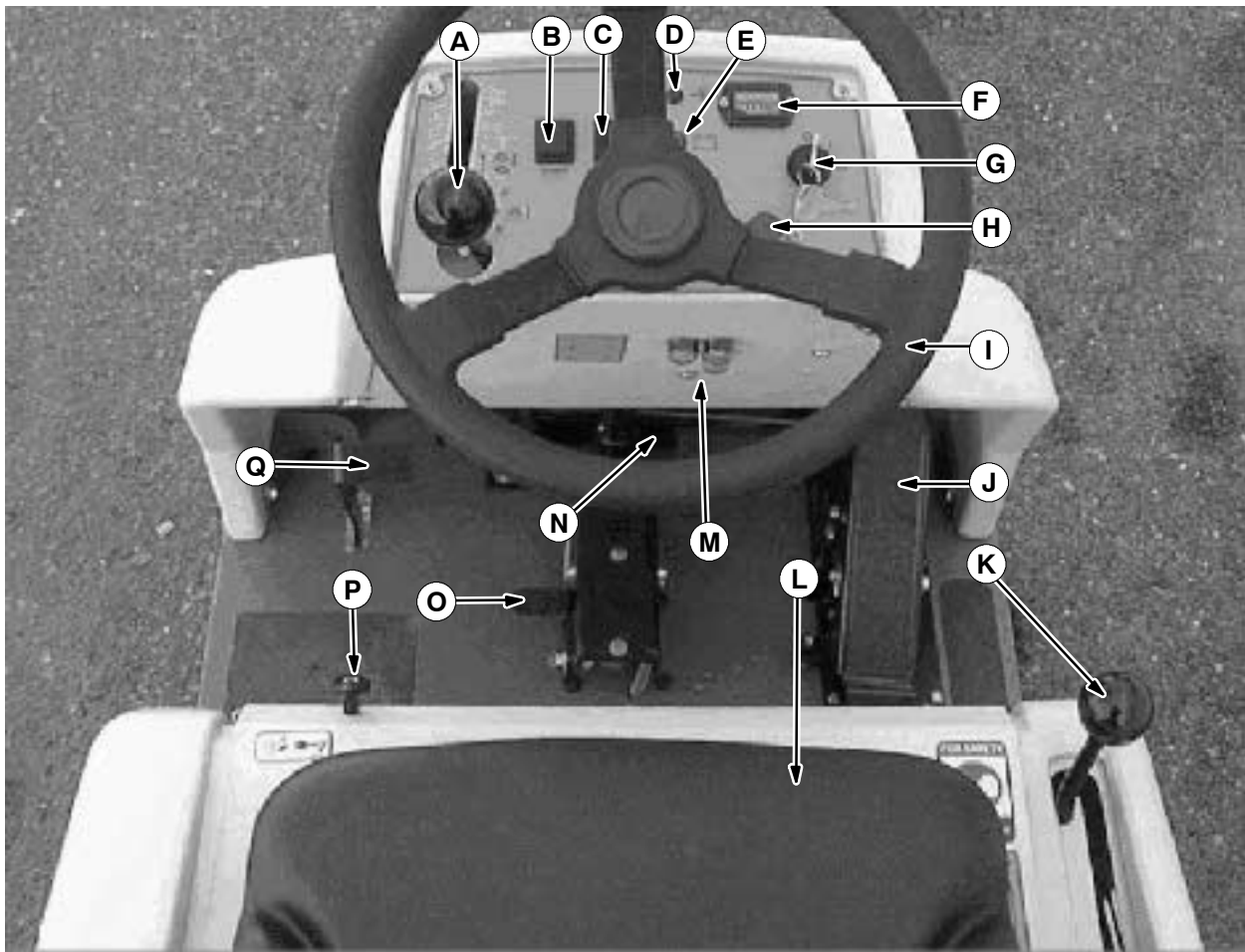

- A. Side brush lever
- B. Vacuum fan/Filter shaker switch
- C. Operating/Hazard lights switch (option)
- D. Engine oil pressure light
- E. Charging system light
- F. Hourmeter
- G. Ignition switch
- H. Horn button
- I. Steering wheel
- J. Directional pedal
- K. Main brush lever
- L. Operator seat
- M. Circuit breaker panel
- N. Brake pedal
- O. Parking brake pedal
- P. Choke knob (gasoline)
- Q. Large debris trap pedal

## OPERATION OF CONTROLS

### DIRECTIONAL PEDAL

The *directional pedal* controls the direction of travel and the propelling speed of the machine. Change the speed of the machine with the pressure of your foot on the pedal; the harder you press the faster the machine travels.

Use the brake pedal to stop the machine.

Forward: Press the top of the directional pedal with the toe of your foot.

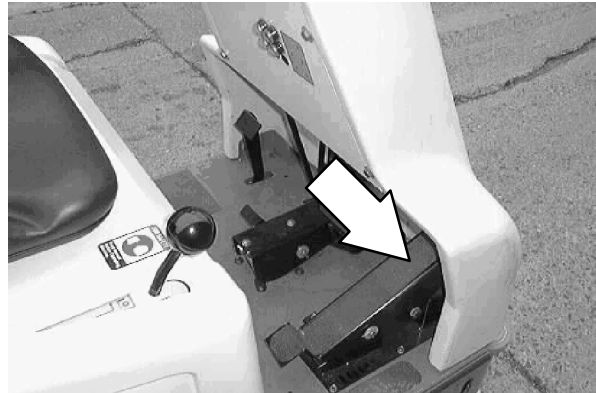

Reverse: Press the bottom of the directional pedal with the heel of your foot.

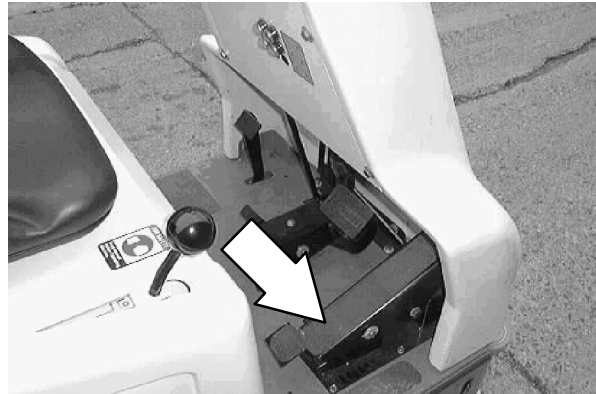

Neutral: Take your foot off the directional pedal and it will return to the **Neutral** position.

*NOTE: The machine may coast when the foot is taken off the directional pedal. Be prepared to step on the brake pedal when removing foot from directional pedal.*



**BRAKE PEDAL**

The *brake pedal* stops the machine.

Stop: Remove your foot from the directional pedal and let it return to the **Neutral** position. Step on the brake pedal to prevent the machine from rolling.

*NOTE: Machine may roll a slight distance when turned off. Keep foot on brake until machine stops moving.*

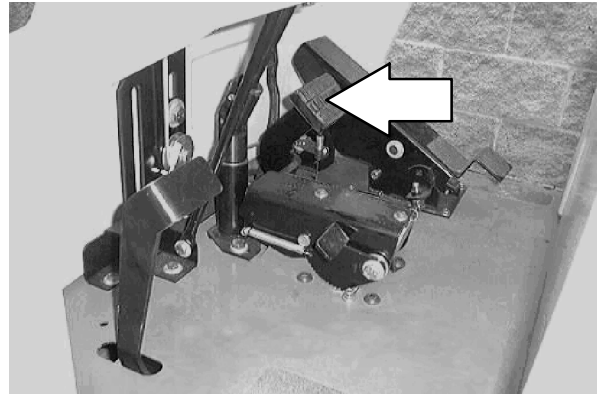
**PARKING BRAKE PEDAL**

The *parking brake pedal* sets and releases the front wheel brake.

Set: Hold the brake pedal with the right foot. Press on the parking brake pedal with the left foot to lock the parking brake pedal in place.

**FOR SAFETY: Before leaving or servicing machine, stop on level surface, set parking brake, turn off machine, and remove key.**

Release: Press down on the brake pedal until the parking brake releases.

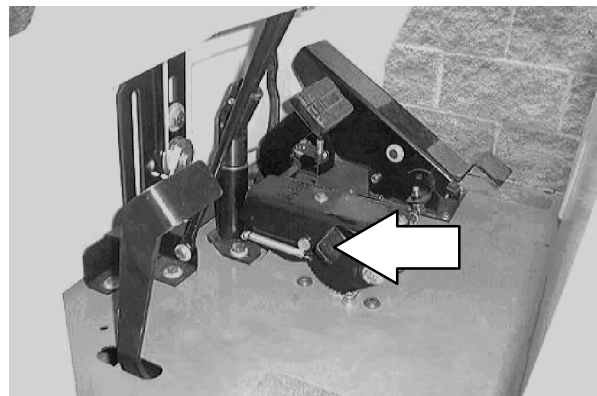
**LARGE DEBRIS TRAP PEDAL**

The *large debris trap pedal* opens the trap flap in front of the main sweeping brush.

Open: Press on the trap pedal when sweeping up larger debris. The flap in front of the main sweeping brush will open.

Close: Release the pedal and the flap will close, trapping larger debris into the hopper.

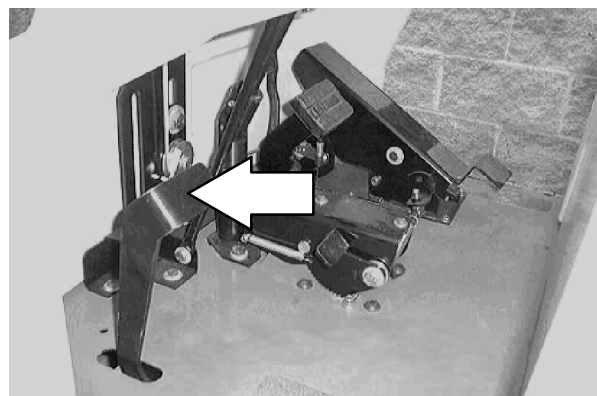

## OPERATION

### MAIN BRUSH LEVER

The *main brush lever* controls the position of the main brush.

Main brush down: Pull the lever to the right and back into the **Main brush down** position.

Main brush up: Push the lever up and to the left into the **Main brush up** position.



### CHARGING SYSTEM LIGHT

The *charging system light* comes on when the alternator is not operating within the normal range; 13.5 to 14.5 V. If the light comes on, stop operating the machine. Locate the problem and have it corrected.

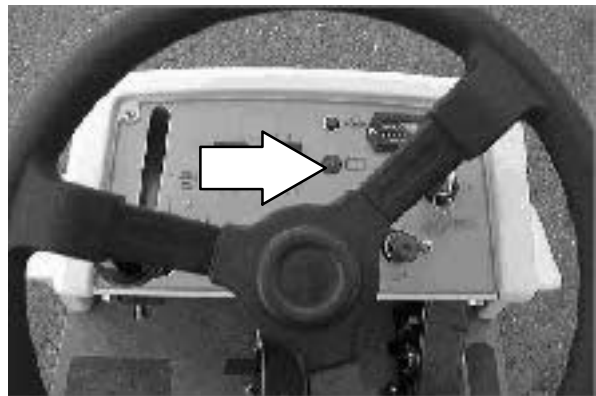

### ENGINE OIL PRESSURE LIGHT

The *engine oil pressure light* comes on when the engine oil pressure falls below 40kPa (5 psi). If the light comes on, stop operating the machine. Locate the problem and have it corrected.

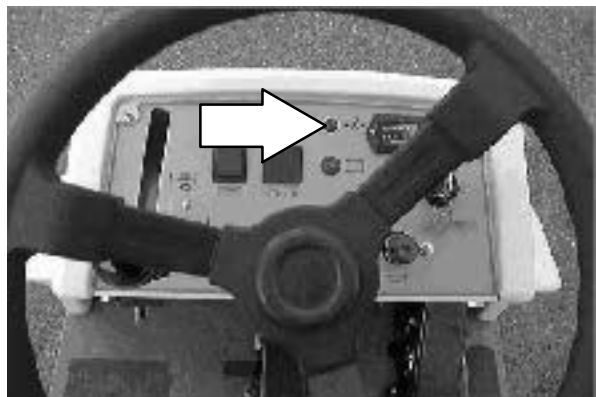

**FUEL LEVEL GAUGE**

The *fuel level gauge* indicates how much fuel is left in the fuel tank.

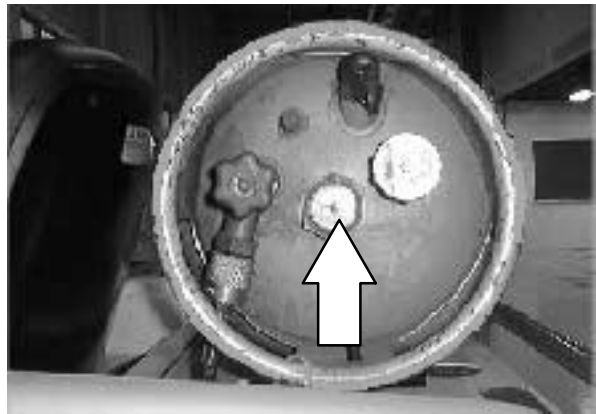
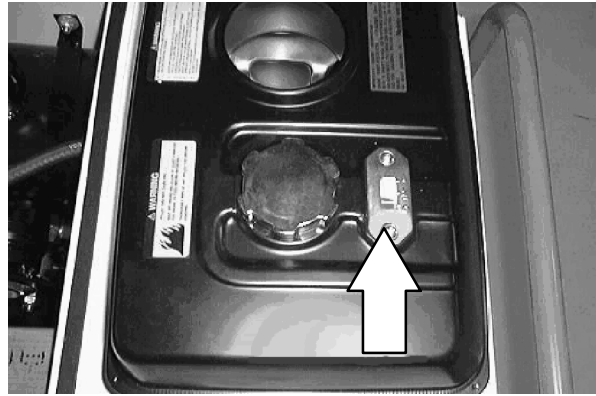
**ENGINE CHOKE KNOB**

The *engine choke knob* controls the engine choke on gasoline powered machines.

On: For cold starting, pull the engine choke knob out.

Off: Push the engine choke knob in.

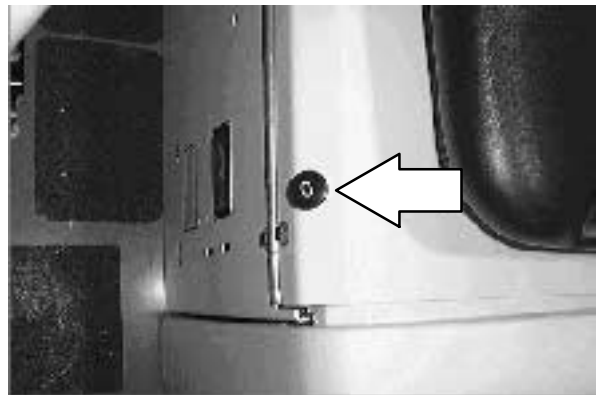

## OPERATION

### VACUUM FAN/FILTER SHAKER SWITCH

The *vacuum fan/filter shaker switch* controls both the vacuum fan damper and the VCS™ *Vibrating Comb Shaker*. The vacuum fan damper should be open when sweeping dry debris, and closed when sweeping wet debris.

Vacuum fan on: Press the top of the switch to the **vacuum fan on** position for dry sweeping.

Vacuum fan off: Press the switch to the middle **vacuum fan off** position for wet sweeping.

Start filter shaker: **Press and hold** the bottom of the switch for eight to ten seconds.

*NOTE: Excessive heat in the hopper will cause the Thermo Sentry™ to close the vacuum fan damper. If this happens, stop the machine, eliminate the source of heat, and reset the switch to the **vacuum fan on** position.*

 **WARNING: Brush throws debris. Stop motor before lifting hopper.**

### STEERING WHEEL

The *steering wheel* controls the machine's direction. The machine is very responsive to the steering wheel movements.

Left: Turn the steering wheel to the left.

Right: Turn the steering wheel to the right.

### HOURMETER

The *hourmeter* records the number of hours the machine has been operated. The hourmeter displays the number of hours in tenths of an hour. Use this information to determine machine maintenance intervals.

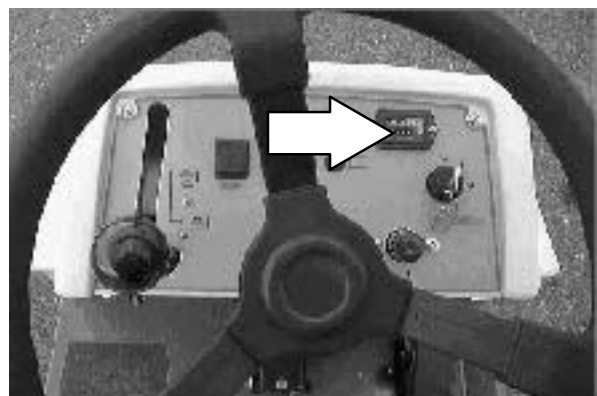
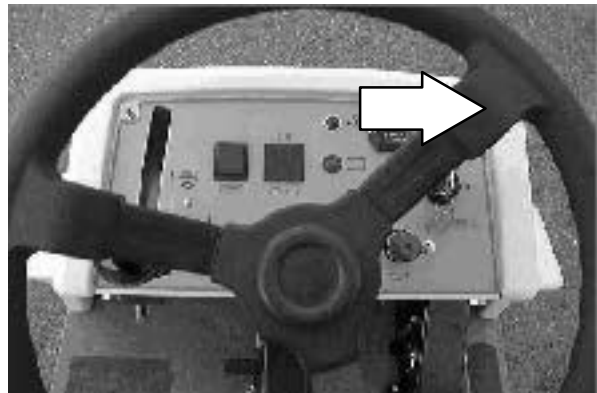
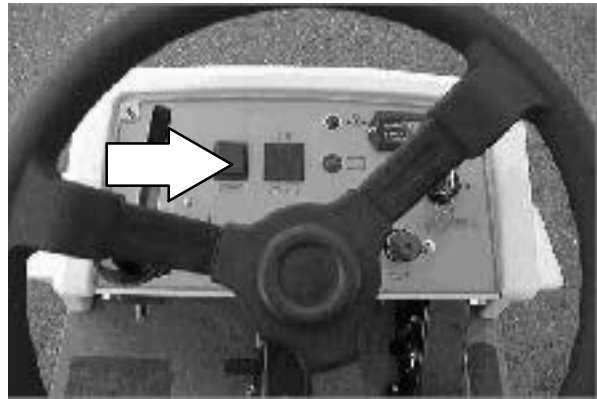

## IGNITION SWITCH

The *ignition switch* controls machine power and main sweeping brush with a key.

**Start:** Turn the key all the way clockwise, and release the key as soon as the engine starts. The vacuum fan and main brush both operate while the engine is running.

**FOR SAFETY: When starting machine, keep foot on brake and directional pedal in neutral.**

**Stop:** Turn the key counterclockwise.

 **WARNING: Brush throws debris. Stop motor before lifting hopper.**

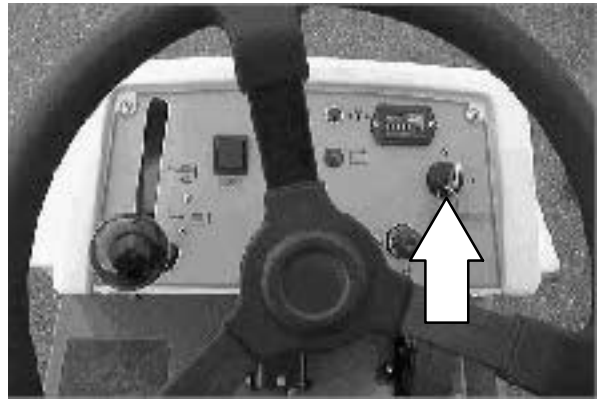

## HORN BUTTON

The *horn button* operates the horn.

**Sound:** Press the button.

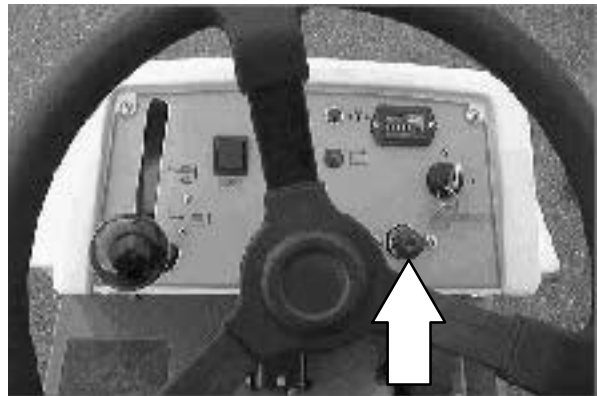

## SIDE BRUSH LEVER

The *side brush lever* controls the position and the power of the side brush.

**Side brush down and on:** Pull the lever left and forward into the **Side brush down and on** position. The brush will automatically start rotating.

**Side brush up and off:** Pull the lever back and to the right into the **Side brush up and off** position.

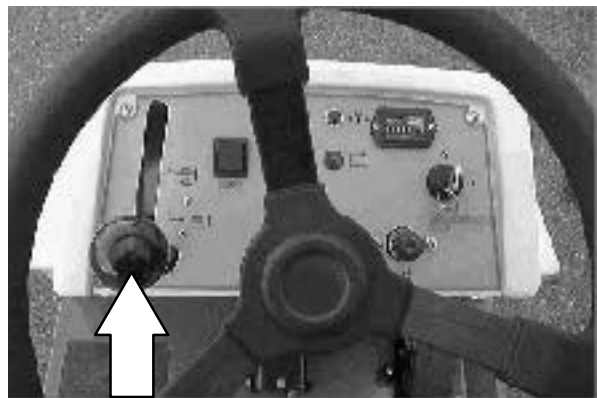

## OPERATION

### OPERATING LIGHTS SWITCH (OPTION)

The *operating lights switch* powers on and off the headlights and taillights option.

On: Press the top of the operating lights switch.

Off: Press the switch to the middle position.

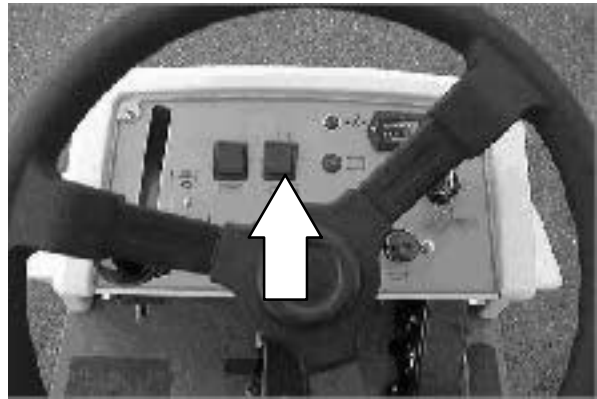

### OPERATING/HAZARD LIGHTS SWITCH (OPTION)

The *operating/hazard lights switch* powers on and off the headlights and taillights option and the hazard light option.

Operating lights on: Press the top of the operating/hazard lights switch.

Operating/Hazard lights on: Press the bottom of the operating/hazard lights switch.

Off: Press the operating/hazard lights switch to the middle off position.

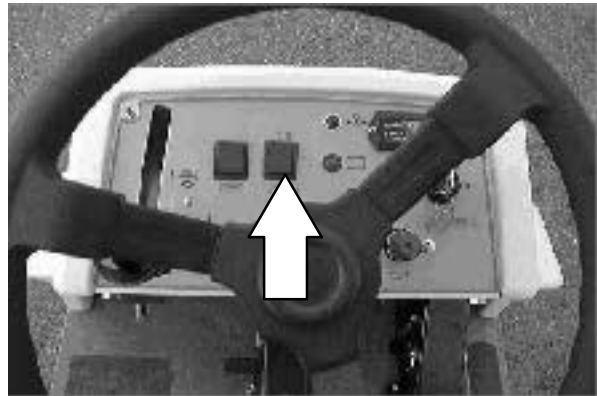



**FUSES**

*Fuses* are one-time protection devices designed to stop the flow of current in the event of a circuit overload. Never substitute higher value fuses than specified.

The fuse is located behind the circuit breaker panel.

Fuse	Rating	Circuit Protected
FU-1	40 A	Main



**CIRCUIT BREAKERS**

The *circuit breakers* are resettable electrical circuit protection devices. Their design stops the flow of current in the event of a circuit overload. Once a circuit breaker is tripped, it must be reset manually. Press the reset button after the breaker has cooled down. The circuit breakers will not reset until they have had a chance to cool down.

If the overload that caused the circuit breaker to trip is still there, the circuit breaker will continue to stop current flow until the problem is corrected.

Circuit breakers 1 through 3 are located above the foot pedals in the circuit breaker panel.

The chart lists the circuit breakers and the electrical components they protect.

Circuit Breaker	Rating	Circuit Protected
CB-1	15 A	Horn / Back up alm
CB-2	15 A	Filter shaker
CB-3	10 A	Main

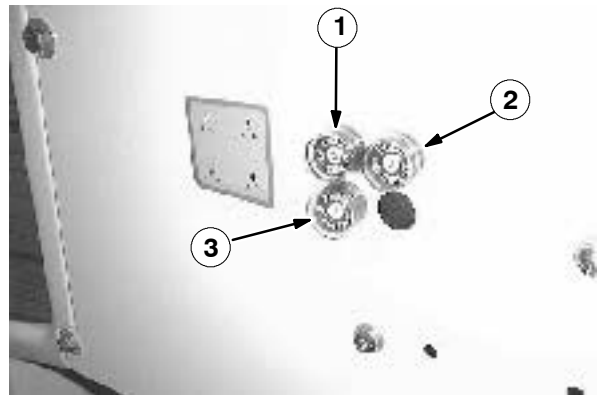

## OPERATION

### OPERATOR SEAT

The *operator seat* is a stationary fixed back style.



### ADJUSTABLE OPERATOR SEAT (OPTION)

This *operator seat* is a fixed back style with a forward-backward adjustment.

Adjust: Pull the lever in, slide the seat backward or forward to the desired position, and release the lever to lock the seat in place.



## HOPPER

The *hopper* is located in the rear of the machine under the hopper filter. The hopper rolls in and out of position and rests in grooves that hold the hopper in place.

The hopper is held in operating position with a retaining clip.

*NOTE: Check that the hopper retaining clip is securely in place each time before operating machine.*



**Remove hopper:** Turn the hopper retaining clip to the horizontal open position. Lift up on the hopper handle. Pull the hopper back out of the machine.

**Replace hopper:** Push hopper back into position under hopper filter. Secure hopper in position with hopper retaining clip.



# OPERATION

---

## HOW THE MACHINE WORKS

---

The steering wheel controls the direction of machine travel. The directional pedal controls the speed and forward/reverse direction. The brake pedal slows and stops the machine.

The side brush sweeps debris into the path of the main sweeping brush. The main brush sweeps debris from the floor into the hopper. The large debris trap pedal opens and closes the large debris trap, trapping large debris into the hopper. The vacuum system pulls dust and air into the hopper through the Instant Access™ filter.

When sweeping is finished, clean the Instant Access™ filter and empty the hopper.

---

## PRE-OPERATION CHECKLIST

---

- Check under the machine for leaks (fuel, oil or hydraulic fluid).

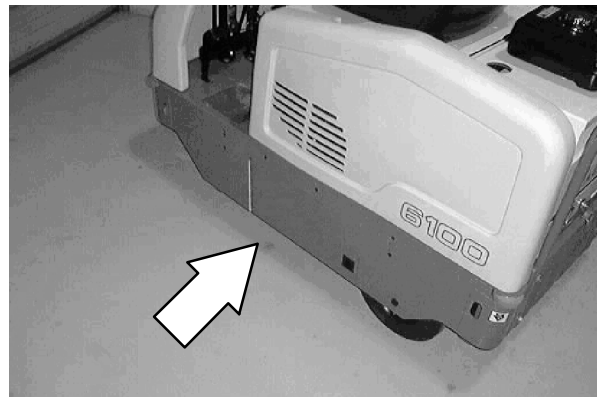

- Check the engine air filter.

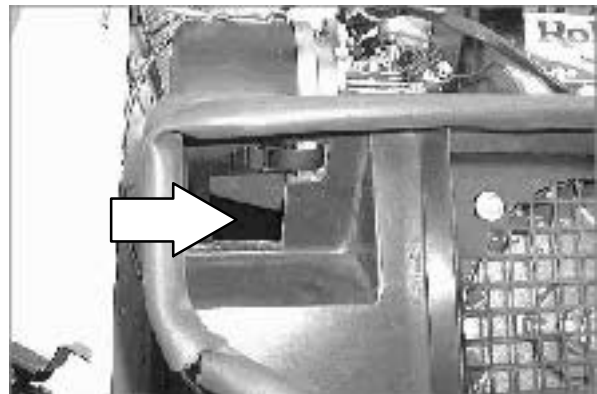

- Check the engine oil level.

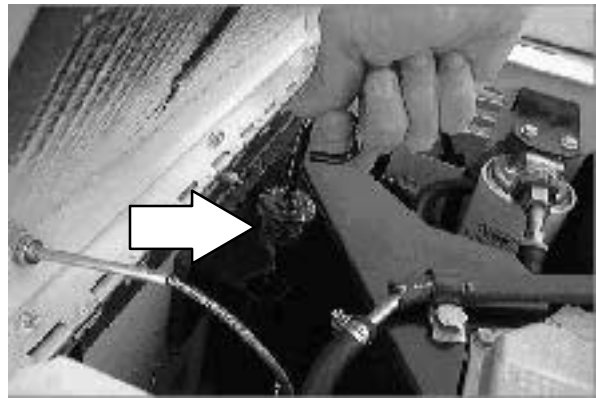

- Check the fuel level gauge.

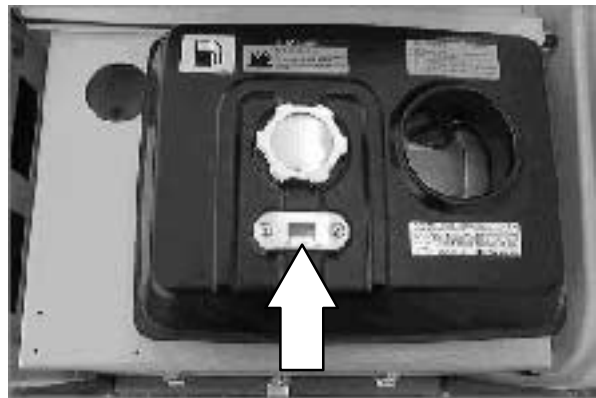

- LPG powered machines: When checking the fuel gauge on the tank, check for LPG odor or frosting on hoses or components indicating an LPG leak.

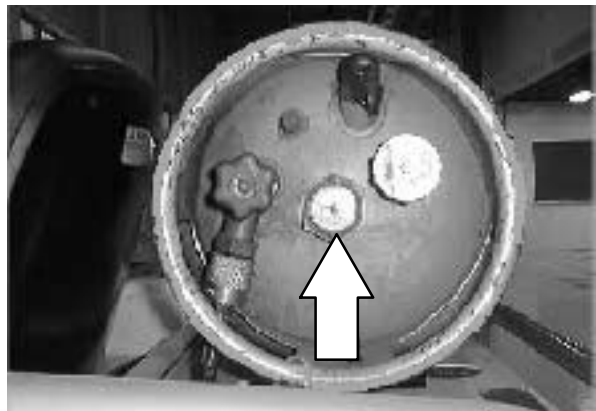

- Check the brakes and steering for proper operation.

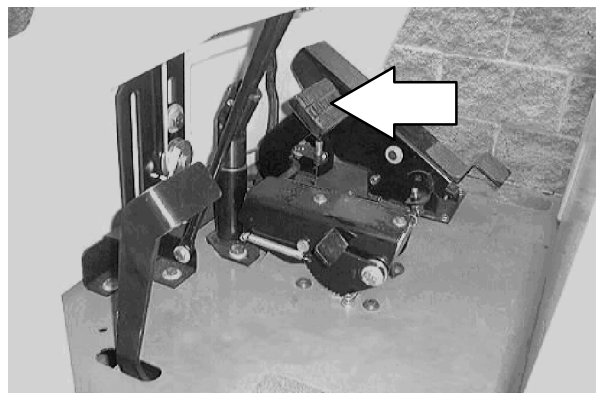

## OPERATION

### CHANGING AN LPG FUEL TANK

1. Park the machine in a designated safe area.
2. Close the tank service valve on the LPG tank located behind the operator seat.
3. Operate the engine until it stops from lack of fuel, then set the machine parking brake.

**FOR SAFETY: When servicing machine, keep flames and sparks away from fuel system service area. Keep area well ventilated.**

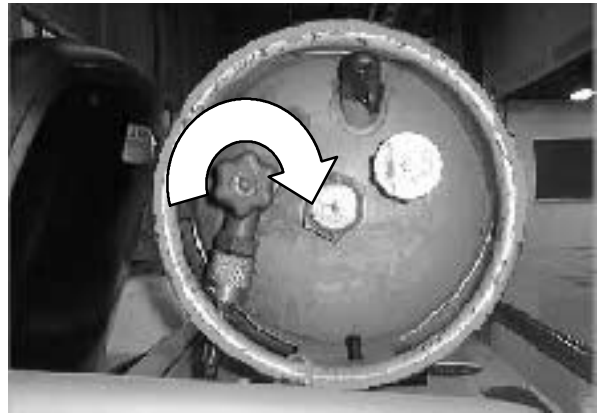

4. Put on gloves and remove the quick-disconnect tank coupling.
5. Unlatch and remove the empty LPG fuel tank from the machine and store the tank in a designated, safe area.



6. Carefully put the filled LPG tank in the machine so that the tank centering pin enters the aligning hole in the tank collar.

*NOTE: Make sure the LPG fuel tank matches the fuel system (vapor tank with vapor system).*

7. Fasten the tank hold-down clamp to lock the tank in position.

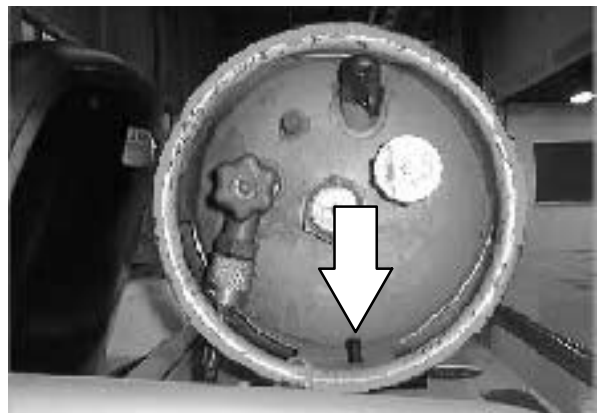

8. Connect the LPG fuel line to the tank service coupling. Make sure the service coupling is clean and free of damage. Also make sure it matches the machine service coupling.



9. Open the tank service valve slowly and check for leaks. Close the service valve immediately if an LPG leak is found, and tell the appropriate personnel.

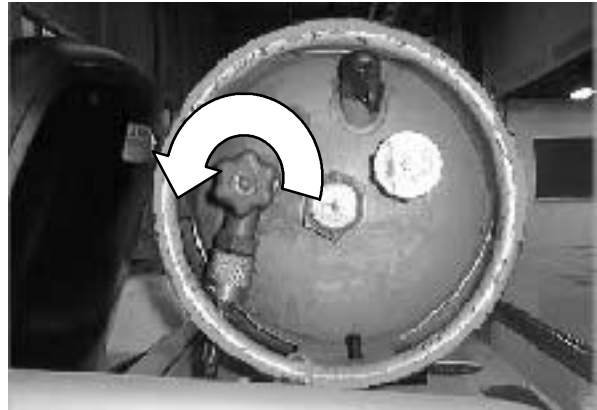

# OPERATION

## STARTING THE MACHINE

1. LPG powered machines: Open the vapor service valve slowly.

*NOTE: Opening the service valve too quickly may cause the service check valve to stop the flow of LPG fuel. If the check valve stops the fuel flow, close the service valve, wait a few seconds and open the valve slowly again.*



2. Sit in the operator's seat and engage the brakes with the directional pedal in neutral.

**FOR SAFETY: When starting machine, keep foot on brake and directional pedal in neutral.**

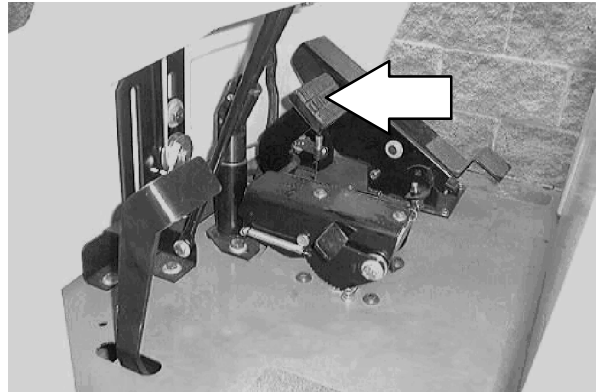

3. Gasoline powered machines: Pull out the choke knob when the engine is cold. Push in the choke knob after the engine is running smoothly.

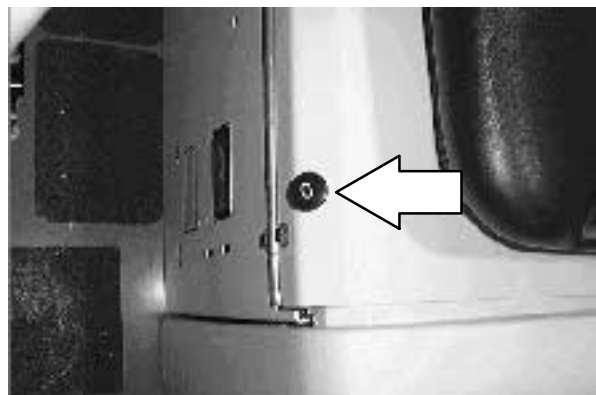



4. Turn the ignition switch key clockwise until the engine starts

*NOTE: Do not operate the starter motor for more than 10 seconds at a time or after the engine has started. Allow the starter to cool between starting attempts or damage to the starter motor may occur.*

5. Allow the engine to warm up two to three minutes.

**⚠ WARNING: Engine emits toxic gases. Severe respiratory damage or asphyxiation can result. Provide adequate ventilation. Consult with your regulatory authorities for exposure limits. Keep engine properly tuned.**

6. Release the machine parking brake.

7. Drive the machine to the area to be cleaned.

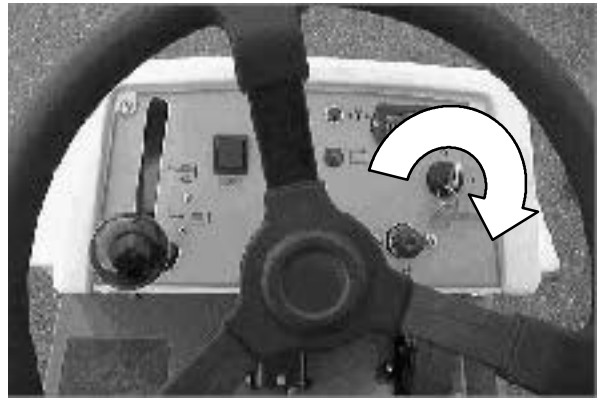

---

## OPERATION ON INCLINES

---

Drive the machine slowly on inclines. Use the brake pedal to control machine speed when descending inclines.

The maximum rated incline is 8° with a full hopper and 10° with an empty hopper.

**FOR SAFETY: When using machine, go slowly on inclines and slippery surfaces.**

---

## SWEEPING AND BRUSH INFORMATION

---

Pick up oversized debris before sweeping. Flatten or remove bulky cartons from aisles before sweeping. Pick up pieces of wire, twine, string, etc., which could become entangled in the brush or brush plugs.

Plan the sweeping in advance. Try to arrange long runs with minimum stopping and starting. Do an entire floor or section at one time. Drive the straightest path possible. Avoid bumping into posts or scraping the sides of the machine. Overlap the brush paths.

Avoid turning the steering wheel too sharply when the machine is in motion. The machine is very responsive to the movement of the steering wheel. Avoid sudden turns, except in emergencies.

For best results, use the correct brush type for your sweeping application. The following are recommendations for main sweeping and side brush applications.

***Polypropylene 8-single row main brush*** – Superior pick-up of sand, gravel, and paper litter. Polypropylene retains its stiffness when wet and can be used indoors or outdoors with equal performance. Not recommended for high-temperature debris.

***Natural Fiber main brush*** – The natural choice for cleaning fine debris on carpet and sweeping very heavy dust and other fine particles on hard surfaces. When cleaning carpet, check brush and perma filter panel regularly for carpet debris.

***Sand wedge main brush*** – A fine brush that handles large quantities of dust and sand with ease.

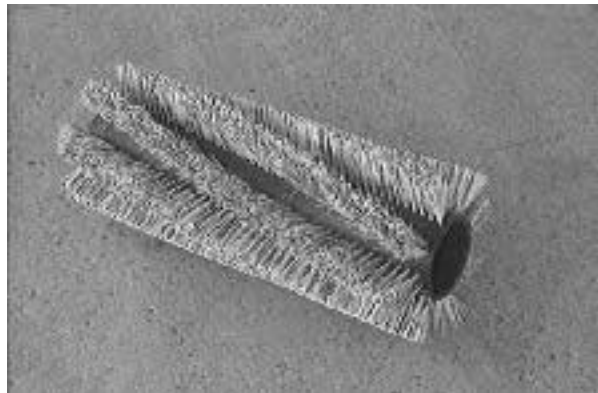

## OPERATION

**Side Brush (2 Row)** – A good general purpose brush for sweeping of light to medium debris in both indoor and outdoor applications. This brush is recommended when bristles may get wet.

**Side Brush (3 Row)** – Improved sweeping performance of fine materials on smooth indoor surfaces.

**Stiff Side Brush** – A longer life, general purpose brush that is recommended for rough surfaces.



---

## SWEEPING

---

1. Press the top of the vacuum fan/filter shaker switch to the vacuum fan damper open position.

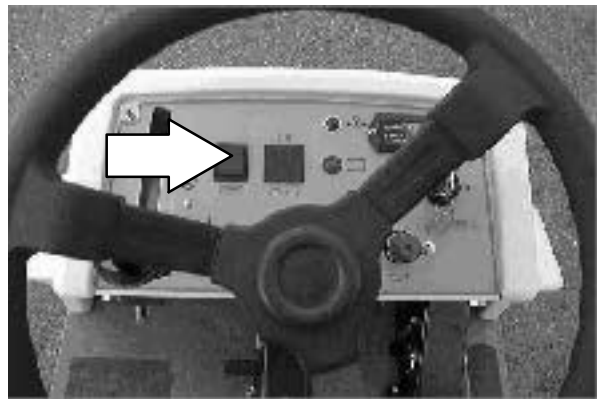

2. Lower the main brush with the main brush lever.



3. Lower and start the side brush with the side brush lever.
4. Begin sweeping.



5. Press down on the large debris trap pedal when sweeping **large debris**.



6. Release the pedal, and the flap will lower over the debris.

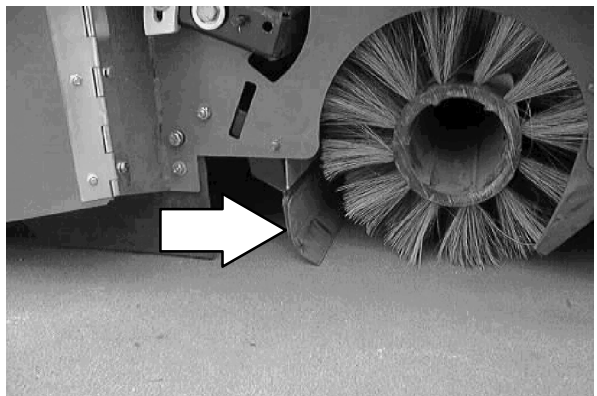

7. The flap will trap large debris back into the hopper.

## OPERATION

### STOP SWEEPING

1. Raise and stop the side brush with the side brush lever.



2. Raise the main brush with the main brush lever.

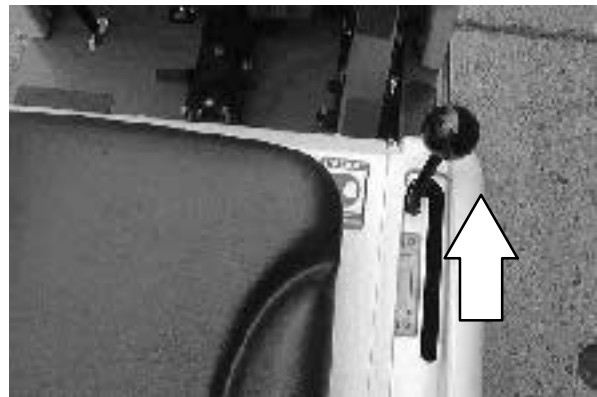

3. Close the vacuum fan damper by pressing the vacuum fan/filter shaker switch to the **middle off position**.

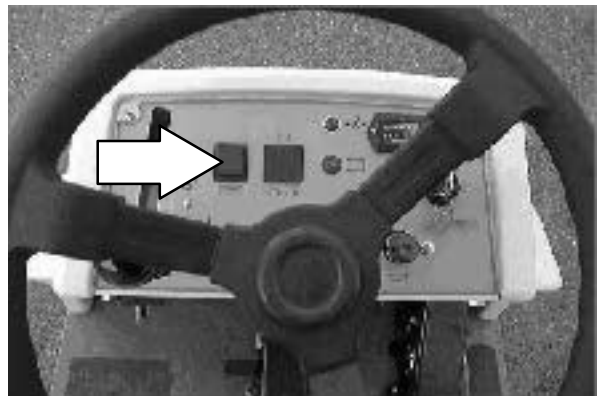

4. Activate the filter shaker by **pressing down and holding** the bottom of the vacuum fan/filter shaker switch for eight to ten seconds.

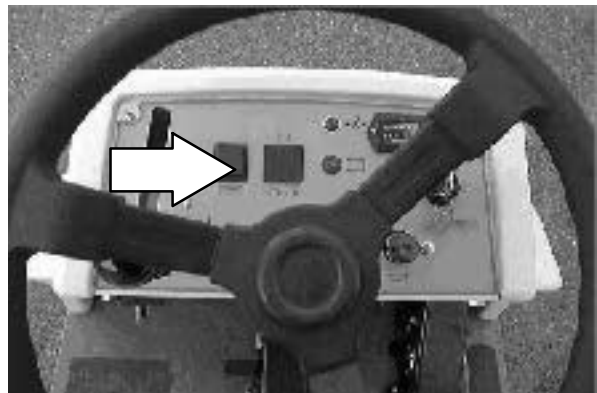

---

**STOPPING THE MACHINE**

---

1. Stop sweeping. See the STOP SWEEPING section of the manual.
2. Take your foot off the directional pedal. Step on the brake pedal.

*NOTE: The machine may coast for a short distance when your foot is removed from the directional pedal. Use the brake pedal to stop the machine.*



3. Set the machine parking brake.

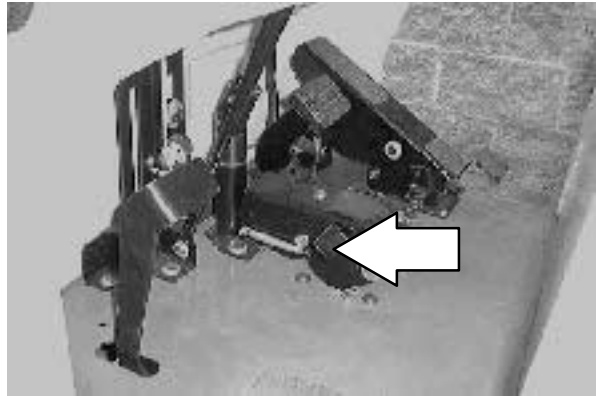

## OPERATION

4. Turn the ignition switch key counterclockwise to turn the machine power off. Remove the switch key.

**FOR SAFETY: Before leaving or servicing machine, stop on level surface, set parking brake, turn off machine, and remove key.**

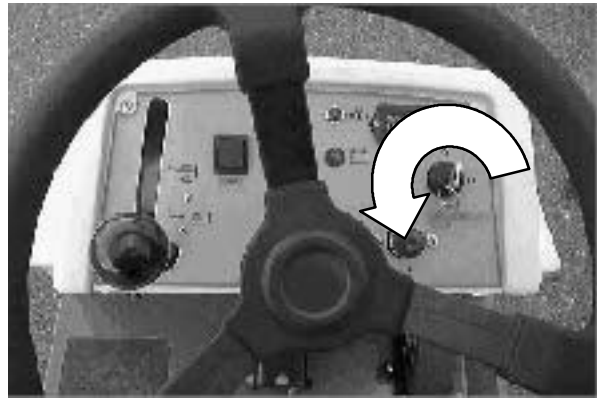

5. LPG powered machines: Close the LPG tank's vapor service valve.

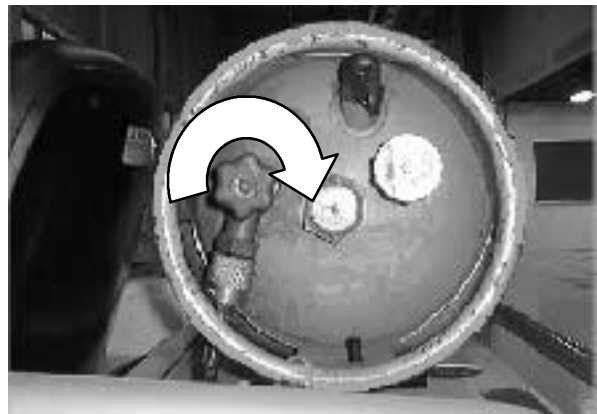



---

**EMPTYING THE HOPPER**

---

1. Stop sweeping. See the STOP SWEEPING section of the manual.

**⚠ WARNING: Brush throws debris. Stop motor before lifting hopper.**

2. Drive the machine to the debris site or debris container.
3. Stop the machine. See the STOP THE MACHINE section of the manual.

**FOR SAFETY: Before leaving or servicing machine, stop on level surface, set parking brake, turn off machine, and remove key.**

4. Turn the hopper retaining clip up into the open position.
5. Firmly lift the hopper handle.



6. Pull back on the hopper handle. Roll the hopper out of machine.



7. Roll the hopper to debris container. Empty the hopper.

**FOR SAFETY: Use care when emptying hopper. Hopper can hold up to 200lbs. Lifting heavy material improperly can result in back strain or other personal injury.**



# OPERATION

## POST-OPERATION CHECKLIST

Check this list of items after you have finished sweeping:

- Check the brush adjustments. See MAIN BRUSH and SIDE BRUSH ADJUSTMENT in the maintenance section of this manual.
- Check the brush skirts for damage, wear, and adjustment.

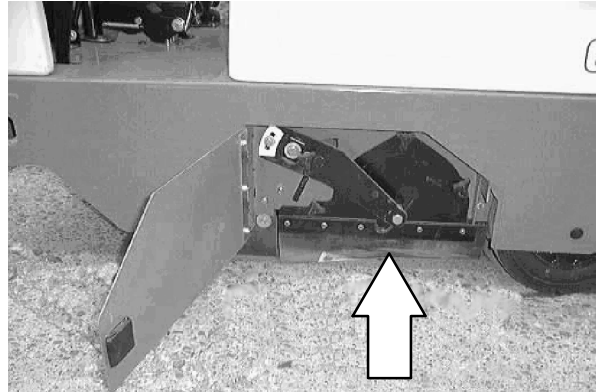

- Check for wire or string tangled on the main brush and side brush.



- LPG powered machines: Check to make sure the LPG tank vapor service valve is closed.
- Check for fuel odor that indicates a fuel leak.
- Check under the machine for leak spots (fuel, oil).
- Check the service records to determine maintenance requirements.

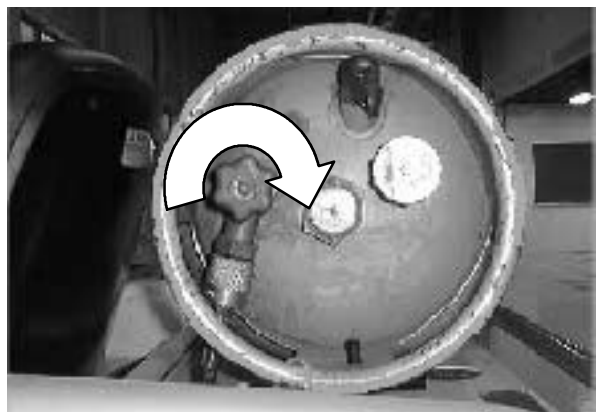

---

**OPTIONS**

---

**QUICK MOP™**

The *QuickMop™* is a front end sweeping attachment that widens the machine's sweeping path.

1. Drive the machine close to QuickMop™ attachment.
2. Set the machine parking brake and turn the machine power off.

**FOR SAFETY: Before leaving or servicing machine, stop on level surface, set parking brake, turn off machine, and remove key.**

3. Connect the QuickMop™ attachment to the mounting bracket on the front of the machine.

4. On older machines, hand tighten the threaded connector knob on the front of the mounting bracket. Release the parking brake and drive to the designated area to be swept.

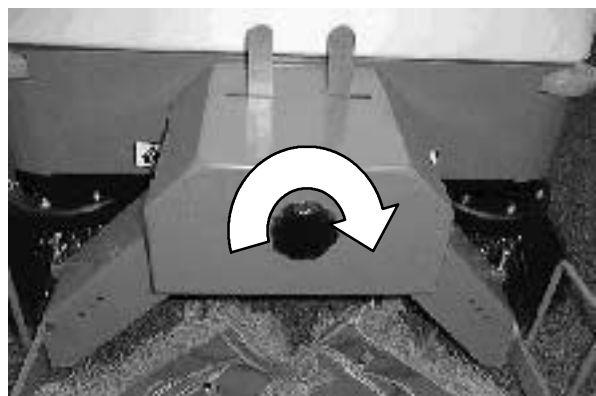
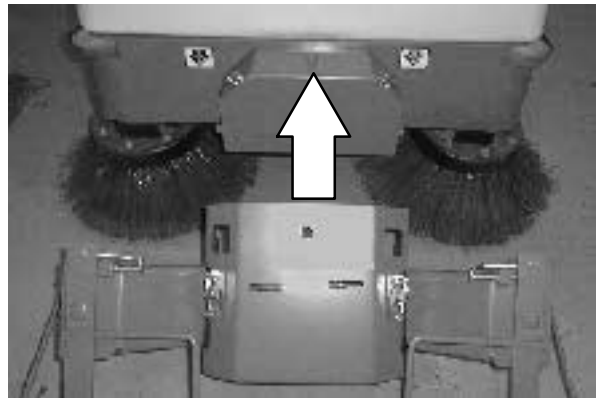

## OPERATION

5. On newer machines, fasten the latches on the front of the mounting bracket. Release the parking brake and drive to the designated area to be swept.

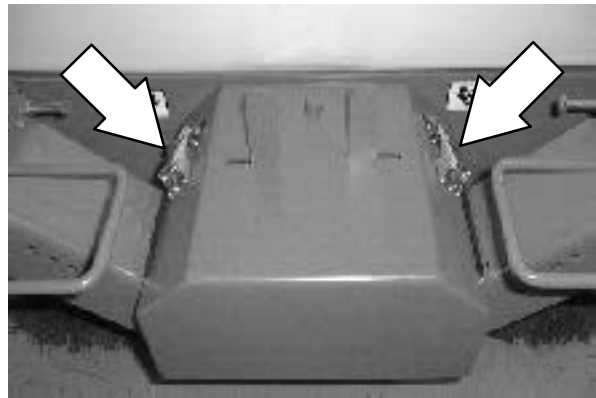

6. Pull the release lever to raise or lower each side of the QuickMop™.



7. Turn the vacuum and brushes on, lower brushes and begin sweeping.



8. Remove and refasten the QuickMop™ head covers with the easy to remove snaps. Remove the head covers to rotate, shake and clean at regular intervals.

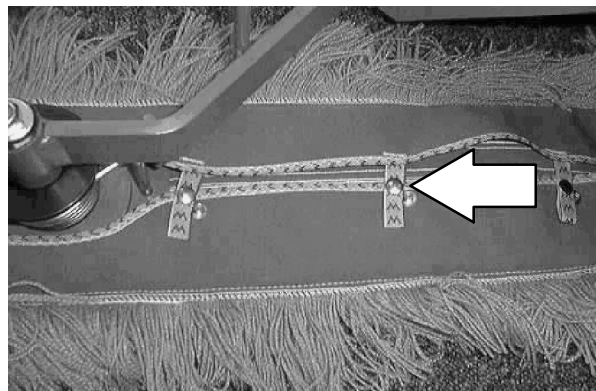

**MACHINE TROUBLESHOOTING**

Problem	Cause	Remedy
Excessive dusting	Vacuum fan damper closed	Press the vacuum fan / filter shaker switch to the on position
	Brush skirts and dust seals worn, damaged, out of adjustment	Replace or adjust brush skirts or dust seals
	Hopper dust filter clogged	Shake and/or clean or replace dust filter
	Hopper full	Empty hopper
	Vacuum fan failure	Contact Tennant service personnel
Poor sweeping performance	Brush bristles worn	Replace brushes
	Main and side brushes not adjusted properly	Adjust main and side brushes
	Debris caught in main brush drive mechanism	Remove debris from drive mechanism
	Main brush drive failure	Contact Tennant service personnel
	Side brush drive failure	Contact Tennant service personnel
	Hopper full	Empty hopper
	Hopper lip skirts worn or damaged	Replace lip skirts
	Wrong sweeping brush	Contact Tennant representative for recommendations
	Large debris trap damaged	Repair or replace large debris trap
	Hopper dust filter clogged	Shake and/or clean or replace dust filter
Machine will not start	Engine oil level low	Check and fill
	Fuel tank valve closed	Open valve - LPG tank valve or valve below gasoline tank

**MAINTENANCE**

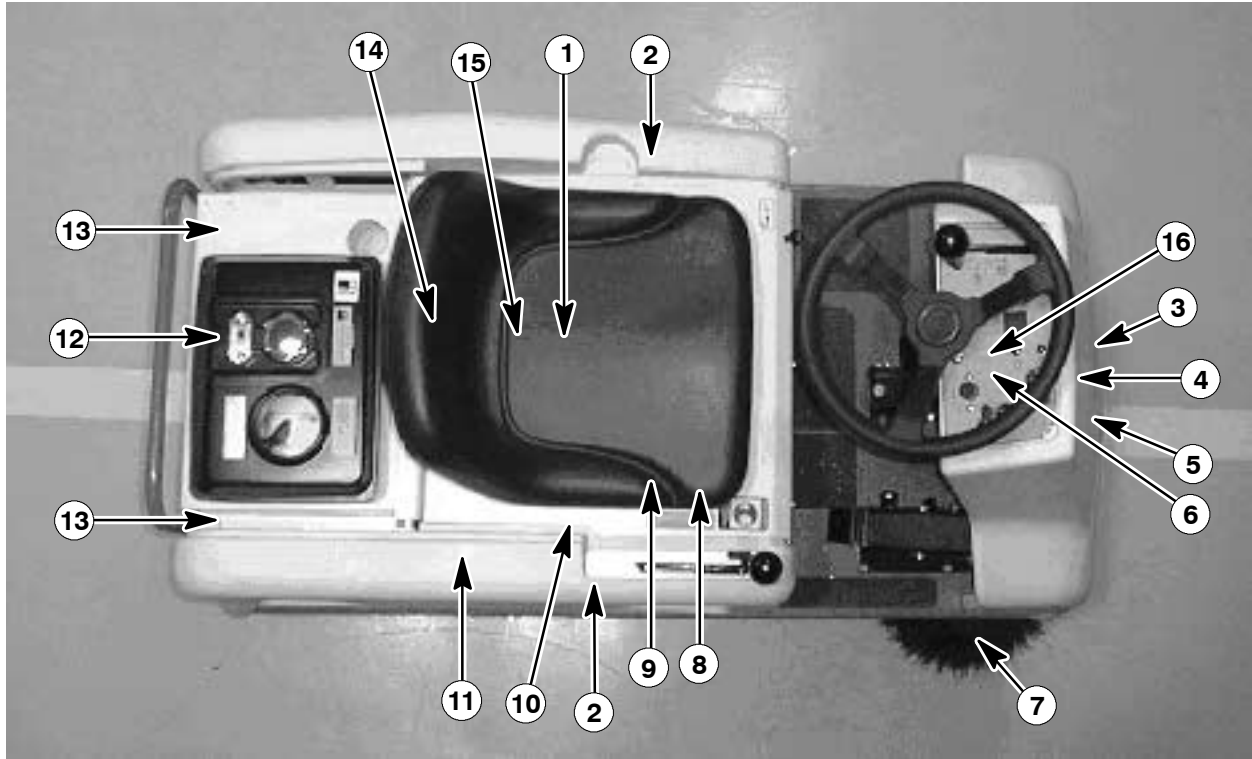

**MAINTENANCE CHART**

Interval	Key	Description	Procedure	Lubricant/ Fluid	No. of Service Points
Daily	1	Engine	Check oil level	EO	1
			Check air intake and cooling areas for debris	-	1
	2	Brush compartment skirts and seals	Check for damage, wear, and adjustment	-	6
	10	Main brush	Check for damage or wear	-	1
	7	Side brush(es)	Check for damage or wear	-	1 (2)
Check brush pattern			-	1 (2)	
13	Hopper dust filter	Shake	-	1	
25 Hours	1	Engine	Clean and re-oil air filter pre-cleaner element	EO	1
50 Hours	1	Engine oil	Change	EO	1
	1	Engine air filter	Replace	-	1
	2	Vacuum fan belt	Check tension and wear	-	1
	10	Main brush	Rotate end-for-end	-	1
			Check brush pattern	-	1
	-	QuickMop™ broom (Option)	Rotate or wash sweep heads	-	2
1	Fuel lines	Check for damage and wear	-	1	

Interval	Key	Description	Procedure	Lubricant/ Fluid	No. of Service Points
100 Hours	1	Engine	Change oil	EO	1
			Clean or replace spark plugs	-	1
			Replace air filter element	-	1
			Clean cooling fins	-	-
	13	Hopper dust filter	Check for damage, clean or replace	-	1
	5	Tires	Check for damage or wear	-	3
	2	Large Debris Trap	Check for damage or wear	-	1
	13	Hopper Seals	Check for damage or wear	-	4
	3	Propelling chain	Check tension and lubricate	EO	1
	11	Vacuum fan belt	Check for tension and wear	-	1
	10	Main brush belt	Check for tension and wear	-	1
	14	Hydraulic pump belt	Check for tension and wear	-	1
	15	Jackshaft belt	Check for tension and wear	-	1
9	Hydraulic fluid reservoir	Check fluid level	HYDO	1	
16	Steering caster pivot bearing	Lubricate and check for wear	SPL	1	
200 Hours	1	Engine	Clean or replace spark plugs	-	1
	12	Fuel tank	Clean fuel screen	-	1
	4	Brake	Check adjustment	-	1
	7	Side brush(es) guard	Check for damage or wear	-	1 (2)
	6	Steering gear chain	Lubricate	EO	1
800 Hours	9	Hydraulic fluid reservoir	Replace filler cap.	-	1
			Replace suction strainer	-	1
			Change hydraulic fluid	HYDO	1
	9	Hydraulic fluid filter	■Change filter element	-	1
	9	Hydraulic hoses	Check for wear and damage	-	-
	3	Propelling motor	■Torque shaft nut	-	3
	8	Battery	■Clean and tighten battery cable connections	-	3

**LUBRICANT/FLUID**

EO . . . Engine oil, SAE 10W30-SG/SH rated

HYDO . TENNANT or approved hydraulic fluid

SPL . . . Special lubricant, Lubriplate EMB grease (TENNANT part no. 01433-1

*NOTE: More frequent intervals may be required in extremely dusty conditions.*

*NOTE: Also check procedures indicated (■) after the first 50 hours of operation.*

## LUBRICATION

---

### ENGINE

Check the engine oil level daily. Change the engine oil after every 100 hours of operation. Use SAE 10W30-SG/SH rated engine oil.

Fill the engine with oil to the level indicated on the oil dipstick. The engine oil capacity is 1.2 L (1.3 qt).

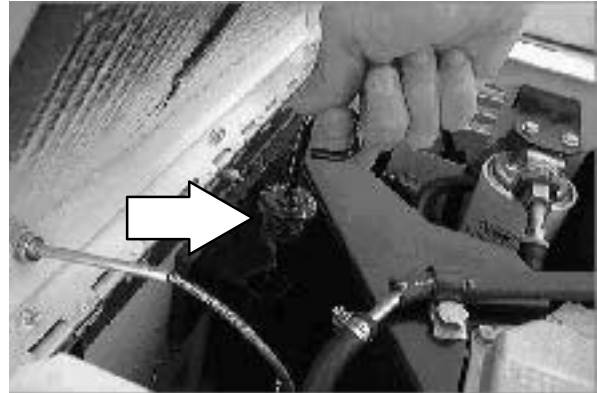

### PROPELLING SYSTEM

The front wheel chain drive/support propels the front wheel to drive the machine. Check the propelling system and chain tension every 100 hours. Proper chain tension is 3 mm (.125 in) from slight tension applied at the midpoint of the longest span. Lubricate the propelling chain with SAE 10W30 weight engine oil after every 100 hours of operation.

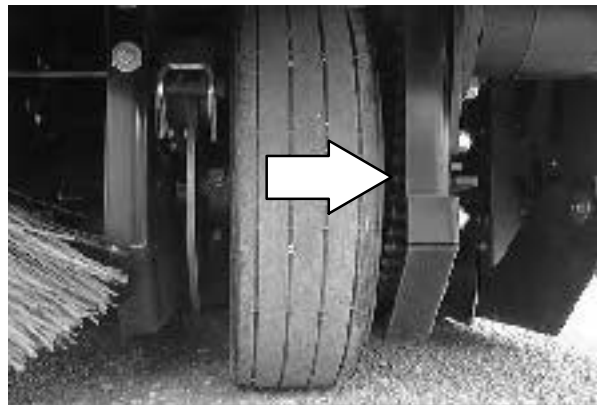



**STEERING GEAR CHAIN**

The steering chain turns the front wheel as the steering wheel is turned. Lubricate the steering chain with SAE 10W30-weight engine oil every 200 hours of operation.

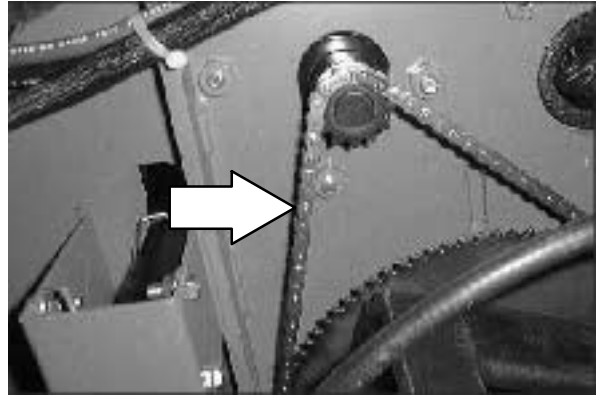
**STEERING CASTOR PIVOT BEARING**

The steering castor bearing is located under the front wheel housing. Lubricate the bearing with Lubriplate EMB grease (TENNANT part no. 01433-1) every 100 hours.

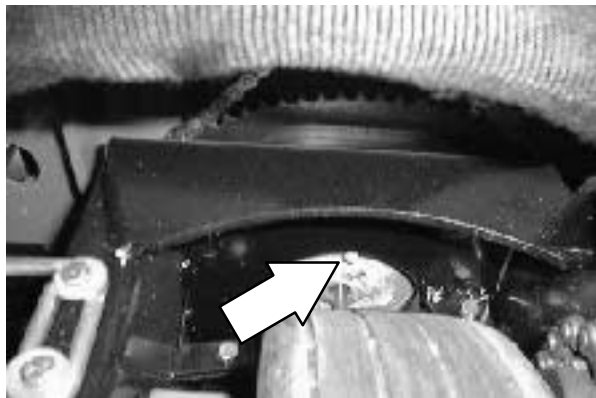

## HYDRAULICS

### HYDRAULIC FLUID RESERVOIR

The reservoir is located in the engine compartment.

A filler cap is mounted on top of the reservoir. It has a built-in breather and fluid level dipstick. Replace the cap after every 800 hours of operation.

Check the hydraulic fluid level at operating temperature after every 100 hours of operation. The end of the dipstick is marked with FULL and ADD levels to indicate the level of hydraulic fluid in the reservoir.

Lubricate the filler cap gasket with a film of hydraulic fluid before putting the cap back on the reservoir.

**ATTENTION! Do not overfill the hydraulic fluid reservoir or operate the machine with a low level of hydraulic fluid in the reservoir. Damage to the machine hydraulic system may result.**

Drain and refill the hydraulic fluid reservoir with new hydraulic fluid after every 800 hours of operation.

The hydraulic fluid filter is located in the engine compartment. Replace the filter element after every 800 hours of operation.

The reservoir has a built-in strainer outlet that filters hydraulic fluid before it enters the system. Replace the strainer after every 800 hours of operation.

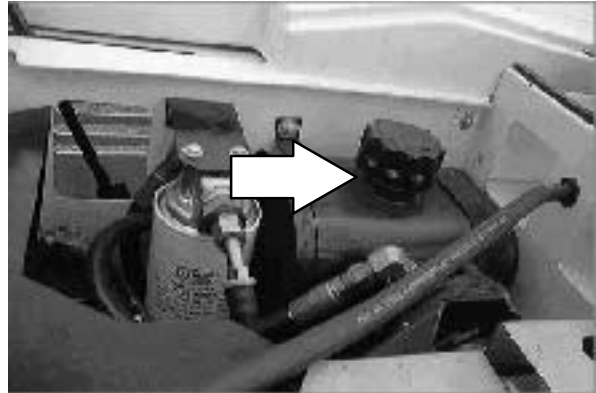

**HYDRAULIC FLUID**

The quality and condition of the hydraulic fluid play a very important role in how well the machine operates. Tennant's hydraulic fluid is specially selected to meet the needs of Tennant machines.

Tennant's hydraulic fluids provide a longer life for the hydraulic components. There are two fluids available for different temperature ranges:

Tennant hydraulic fluid	
Part number	Ambient temperature
65869	above 7° C (45° F)
65870	below 7° C (45° F)

The higher temperature fluid has a higher viscosity and should not be used at the lower temperatures. Damage to the hydraulic pumps may occur because of improper lubrication.

The lower temperature fluid is a thinner fluid for colder temperatures.

If a locally available hydraulic fluid is used, make sure the specifications match Tennant hydraulic fluid specifications. Using substitute fluids can cause premature failure of hydraulic components.

**ATTENTION! Hydraulic components depend on system hydraulic fluid for internal lubrication. Malfunctions, accelerated wear, and damage will result if dirt or other contaminants enter the hydraulic system.**

**HYDRAULIC HOSES**

Check the hydraulic hoses after every 800 hours of operation for wear or damage.

Fluid escaping at high pressure from a very small hole can be almost invisible, and can cause serious injuries.

See a doctor at once if injury results from escaping hydraulic fluid. Serious infection or reaction can develop if proper medical treatment is not given immediately.

**FOR SAFETY: When servicing machine, use cardboard to locate leaking hydraulic fluid under pressure.**

If you discover a fluid leak, contact your mechanic or supervisor.

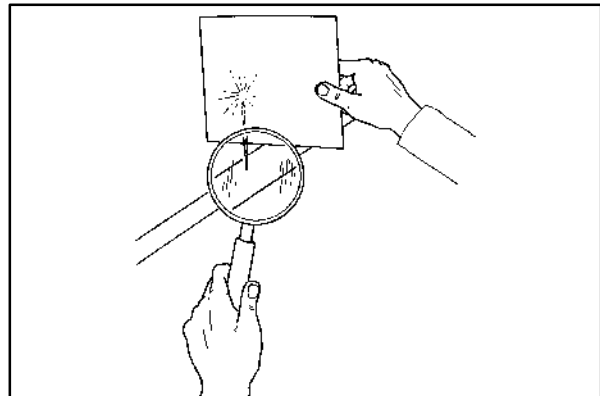

00002

## ENGINE

Maintaining cooling system efficiency is important. Engine temperatures must be brought up to and maintained within the satisfactory range for efficient operation. However, the engine must be kept from overheating in order to prevent damage to the valves, pistons, and bearings. Check the air intake and cooling areas for debris, clean if necessary.

Clean the cooling fins and external surfaces after every 100 hours of operation by removing the blower housing and cooling shrouds. Make sure the cooling shrouds are reinstalled.

**FOR SAFETY: When servicing machine, wear eye and ear protection if using pressurized air or water.**

### AIR FILTER

The engine air filter is made up of two parts, an outer precleaner element and an inner air filter element. The precleaner element must be cleaned and re-oiled after every 25 hours of operation. The air filter element should be replaced after every 100 hours of operation. The air filter element must be replaced if it is damaged.

To clean the precleaner element, remove the air filter cover. Remove the precleaner element, wash in liquid detergent and water, and squeeze it dry in a cloth. After cleaning the precleaner element, inspect it for damage.

Oil the precleaner element with 30cc (1oz) of clean engine oil. Squeeze the precleaner element to distribute the oil evenly throughout the foam.

Remove the air filter element. Carefully clean the covers and the interior of the housing with a damp cloth. Clean the housing sealing surfaces. Inspect the inner air filter element for damage. The slightest rupture requires replacement of the element. Inspect the seals on the ends of the element. They should be flexible and undamaged.



**FUEL SCREEN**

There is a fuel screen on the inside of the fuel tank. Remove and clean the screen every 200 hours of machine use.

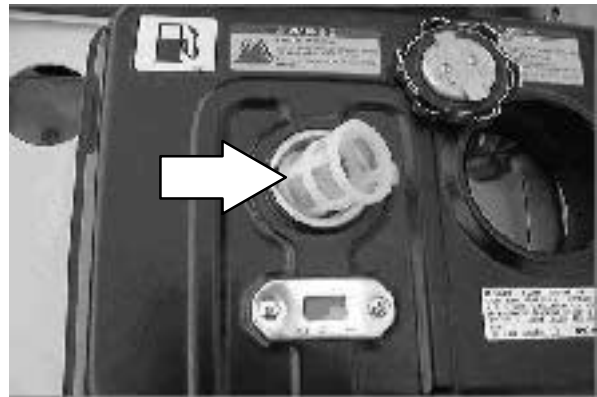

**FUEL LINES**

Check the fuel lines every 50 hours of operation. If any band clamps are loose, apply oil to the screw of the band, and securely tighten the band.

Made of rubber, the fuel lines may become worn out wether the engine has been used much or not. Replace the fuel lines and hose clamps every two years.

**FOR SAFETY: When servicing machine, keep flames and sparks away from fuel system service area. Keep area well ventilated**

If the fuel lines and hose clamps are found worn or damaged before two years' time, replace or repair them at once. Bleed the fuel system after replacement of any fuel lines. When the fuel lines are not installed, plug both ends with clean cloth or paper to prevent dirt from entering the lines.



## MAINTENANCE

---

### CARBURETOR

The carburetor is designed to deliver the correct fuel-to-air mixture to the engine under all operating conditions. The high idle is set at the factory and cannot be adjusted. The low idle fuel adjusting needle is also set at the factory and normally does not need adjustment.

If the engine is hard-starting, hard starting or stalls at low idle speed, it may be necessary to adjust or service the carburetor.

### SPARK PLUGS

Clean or replace and set the gap of the spark plugs after every 100 hours of operation.

The proper spark plug gap is .6 mm (0.024 in) for gasoline engines and LPG engines.

### BATTERY

The battery for the machine is a low maintenance battery. Do not add water to the battery, or remove the battery vent plugs.

The battery is located in the engine compartment.

After the first 50 hours of operation, and after every 800 hours after that, clean and tighten the battery connections.

**FOR SAFETY: When servicing machine, avoid contact with battery acid.**

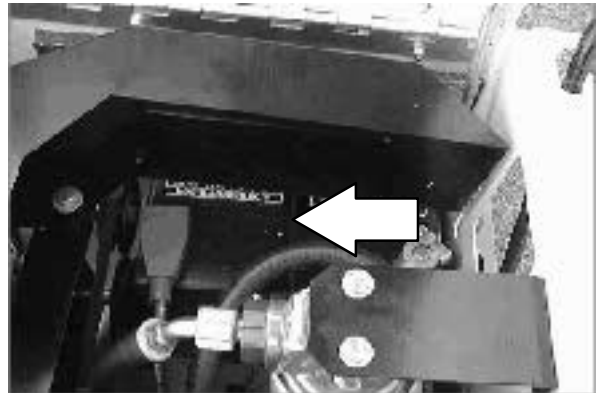

---

**BELTS AND CHAINS**

---

**VACUUM FAN BELT**

The vacuum fan belt drives the vacuum system. Check the belt for wear and tension after every 100 hours of operation.

The correct tension is when the belt deflects 12.7 mm (0.50 in) from a force of 15 kg (30 to 40 lb) at belt midpoint.

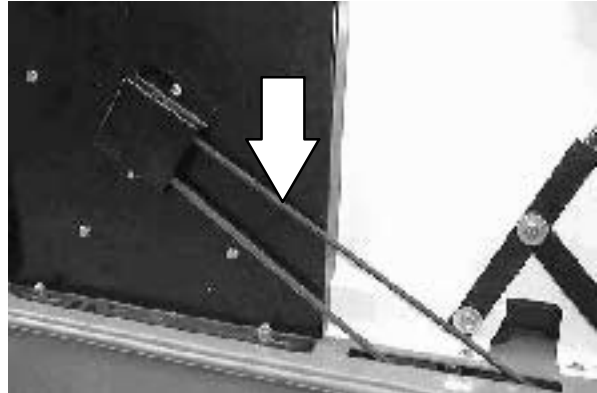
**MAIN BRUSH BELT**

Check the main brush belt for wear after every 100 hours of operation. The idler keeps tension on the belt.

The correct static tension on the main belt is 7.63 kg (16.95 lb.) with 6.14 kg (13.65 lb) of force from the idler pulley.

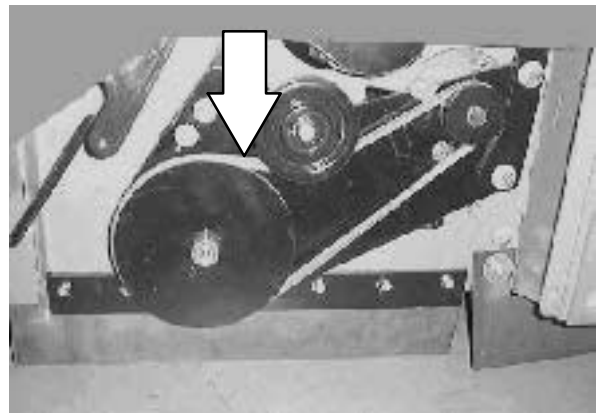

## MAINTENANCE

### HYDRAULIC PUMP BELT

The hydraulic pump belt drives the hydraulic pump. Check the belt for tension and wear every 100 hours of operation.

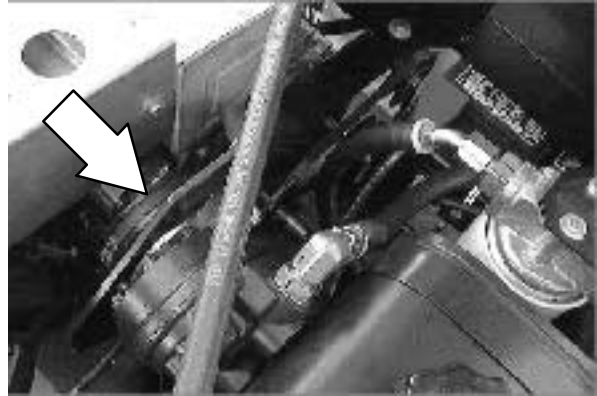

### JACKSHAFT BELT

The jackshaft belt turns the jackshaft that drives the main brush and vacuum fan belts. Check the belt for tension and wear every 100 hours of operation.

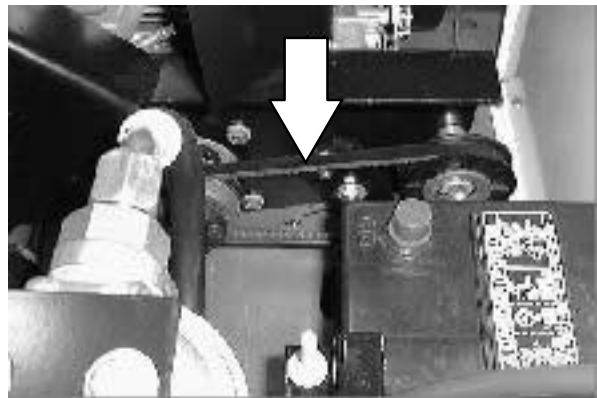



**PROPELLING SYSTEM**

The front wheel chain drive/support propels the front wheel to drive the machine. Check the propelling system and chain tension every 100 hours. Proper chain tension is 3 mm (.125 in) from slight tension applied at the midpoint of the longest span. Lubricate the propelling chain with SAE 10W30-weight engine oil after every 100 hours of operation.

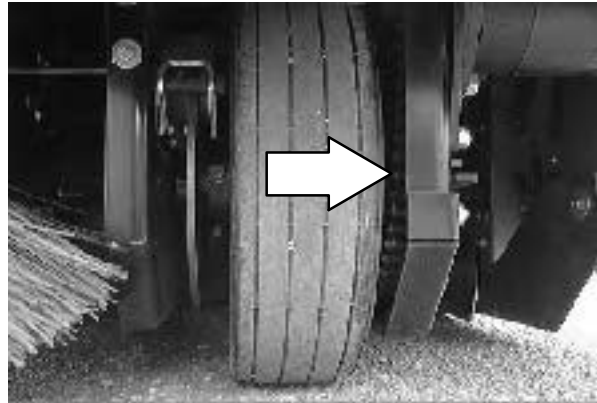

**STEERING GEAR CHAIN**

The steering chain turns the front wheel as the steering wheel is turned. Lubricate the steering chain with SAE 10W30-weight engine oil every 200 hours of operation.

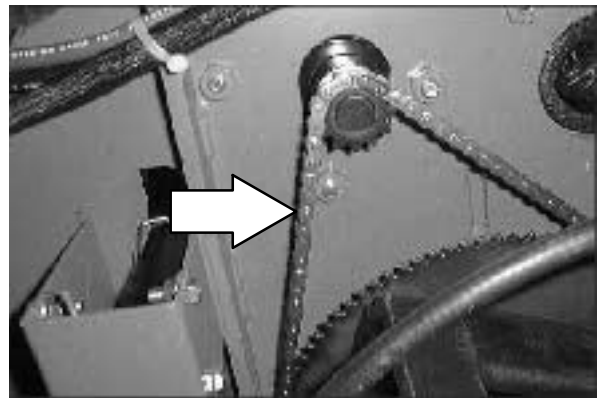

**STATIC DRAG CHAIN**

A static drag chain prevents the buildup of static electricity in the machine. The chain is attached to the machine by a rear main brush skirt retaining bolt.

Make sure the chain is touching the floor at all times.



## DEBRIS HOPPER

---

### INSTANT ACCESS™ HOPPER FILTER

The Instant Access™ hopper filter filters the air pulled up from the hopper. The dust filter is equipped with a VCS™ *Vibrating Comb Shaker* system to remove the accumulated dust particles. The VCS™ shaker system is operated by the vacuum fan/filter shaker switch.

Shake the dust filter before emptying the hopper and at the end of every work shift. Check and clean or replace the dust filter after every 100 hours of operation.

To clean the Instant Access™ filter, use one of the following methods:

- **SHAKING** - Press and hold the main brush, vacuum and filter shaker switch to the **Filter shaker** position.
- **TAPPING** - Remove the filter and tap the filter gently on a flat surface with the dirty side down. Do not damage the edges of the filter element and seals, or the filter will not seat properly in the filter frame.
- **AIR** - Blow air through the dust filter, opposite the direction of the arrows. This may be done with the dust filter in the machine. Always wear eye protection when using compressed air.

**FOR SAFETY: When servicing machine, wear eye and ear protection if using pressurized air or water.**

- **WATER** - Soak the dust filter in a water and mild detergent solution. Rinse the dust filter until it is clean. Air dry the wet dust filter; do not use compressed air to dry a wet filter.

*NOTE: Be sure the dust filter is completely dry before reinstalling it in the machine.*



**REMOVING INSTANT ACCESS™ FILTER**

1. Stop the machine, set the parking brake and turn the machine power off.

**FOR SAFETY: Before leaving or servicing machine, stop on level surface, set parking brake, turn off machine, and remove key.**

2. Turn the hopper retaining clip and remove hopper.

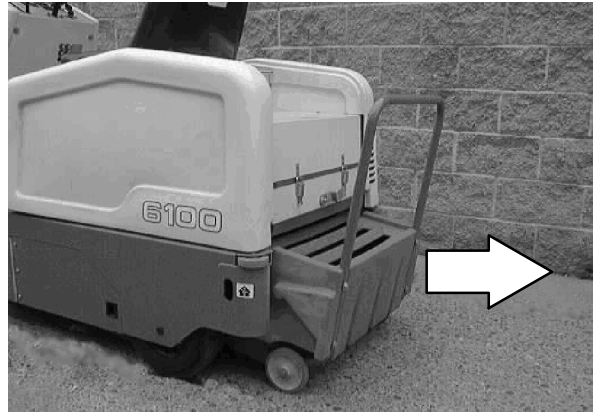

3. Unlatch the two dust filter securing latches above the hopper storage area.

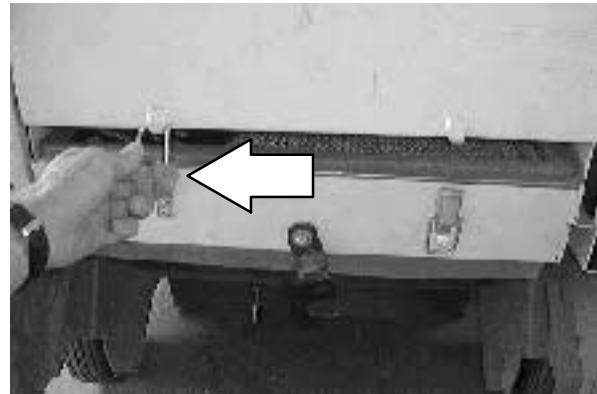

4. Lower the hopper filter down to access the VCS™ filter shaker.

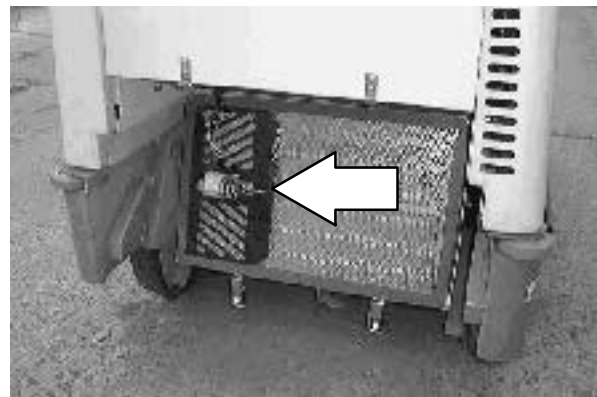

## MAINTENANCE

5. Unplug the electrical harness connection from the VCS™ system filter shaker.

*NOTE: Carefully pull the wires apart from the bodies of the plugs. Do not unplug the connections from the shaking mechanism. Do not pull on the wires. Damage could occur to the wires or the shaking mechanism.*

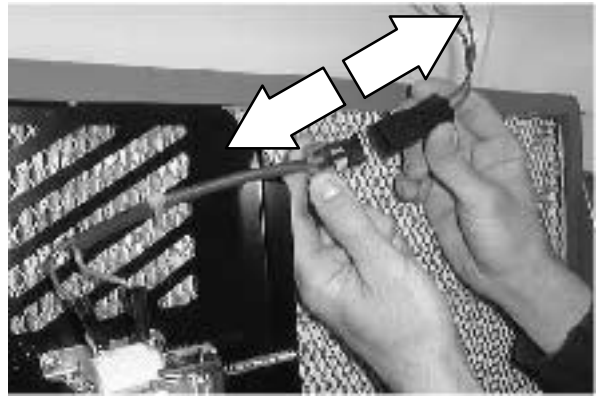

6. Lift the Instant Access™ filter from filter tray.



7. Lift the VCS™ system filter shaker off of the filter.

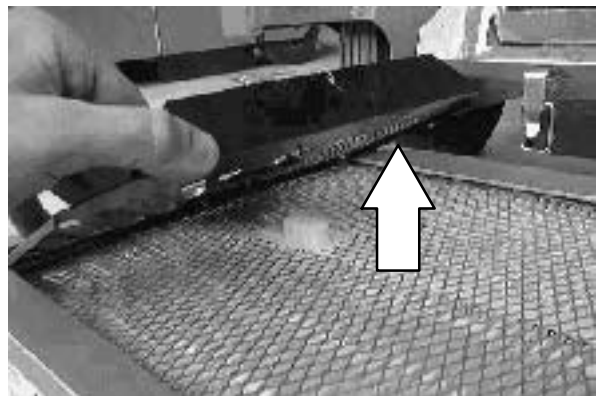

8. Clean or discard the Instant Access™ filter as required.

9. Replace the VCS™ system filter shaker. Use care to insert the shaking pin into the filter comb correctly.

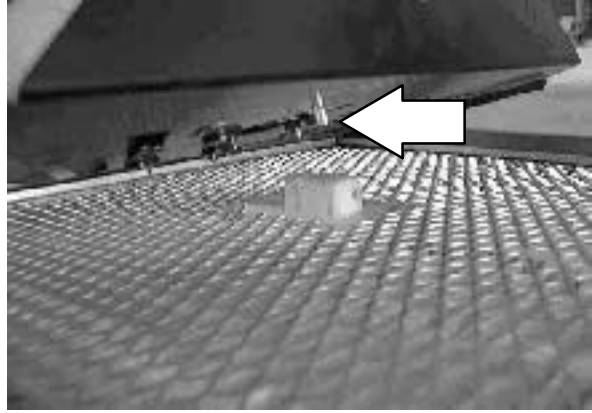

10. Place the edges of the shaker firmly between the filter and the filter seal.

*NOTE: When installed properly, the shaker plate cannot move in either front-to-back or side-to-side directions. If the shaker is loose, it will not function properly.*

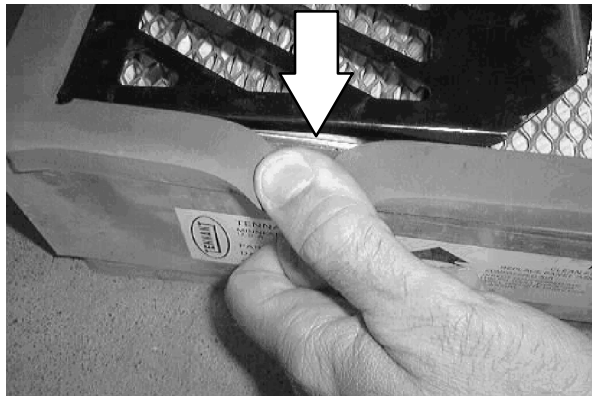

11. The filter shaker should lay flat against the filter. Check to make sure the comb tab is not caught below the filter shaker plate.

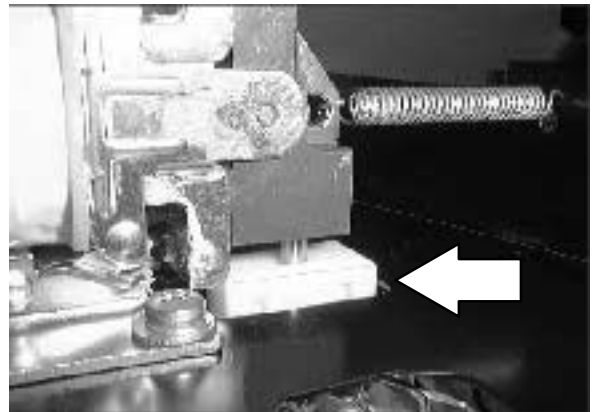

## MAINTENANCE

12. Check the shaker solenoid gap with the end of the shipping tab. The gap should be the same width as the tab. If it is not, loosen the mounting screws, adjust the gap by repositioning the shaker solenoid, then retighten the screws.

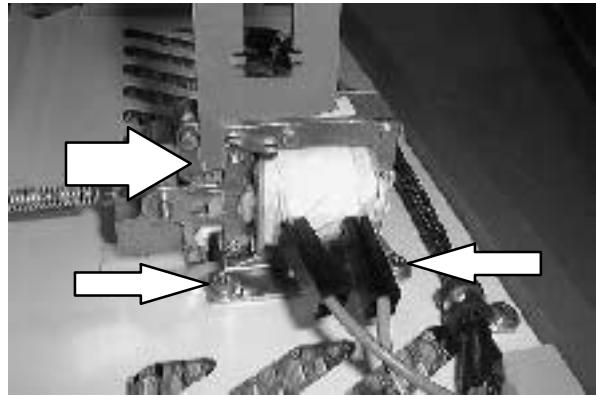

13. Return the filter to the hopper filter weldment.



14. Reconnect the electrical harness to the shaker mechanism harness.

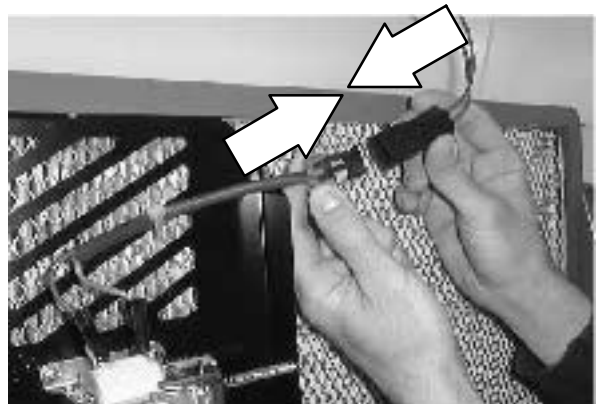

15. Close hopper filter tray and secure with tray latches.

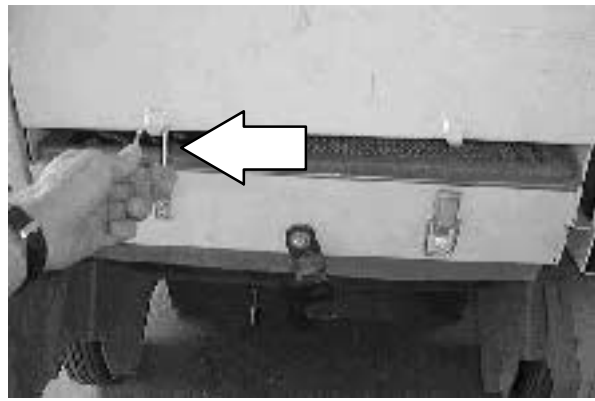

16. Check all of the hopper seals for wear.

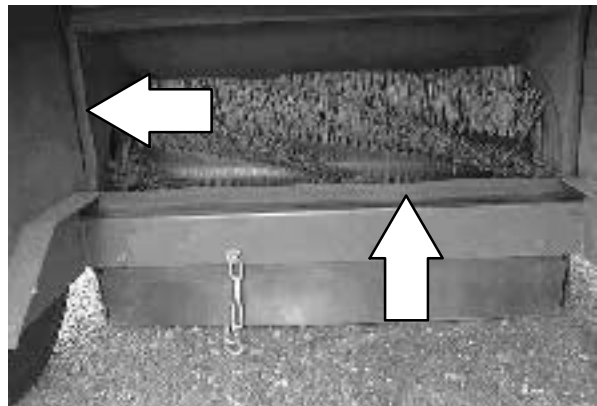

17. Replace the hopper.

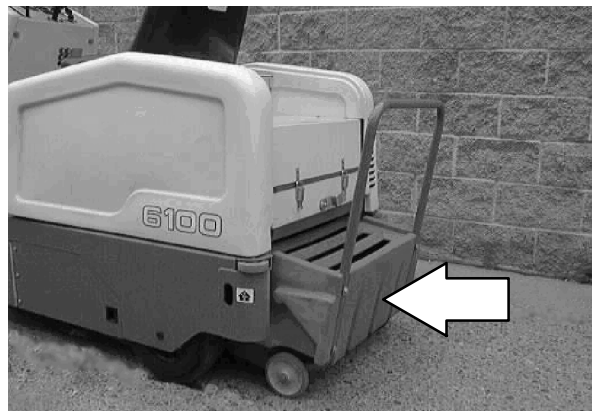

**THERMO SENTRY™**

The Thermo Sentry™ is located inside the debris hopper.

If a fire ignites in the hopper, the Thermo Sentry™ will close the vacuum fan damper. The damper will cut off air flow and help extinguish the fire. If this occurs, drive the machine to a safe location, remove the hopper and eliminate the source of heat.

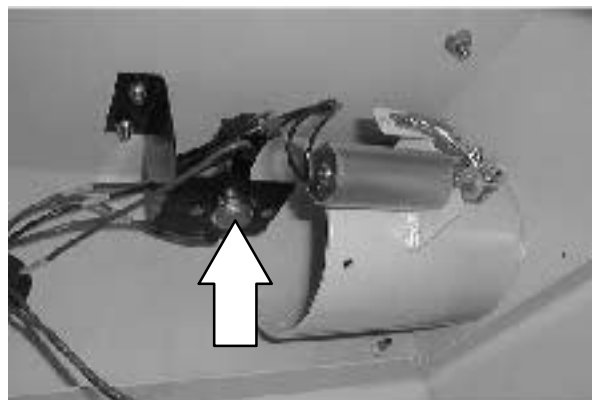

## BRUSHES

### MAIN BRUSH

The main brush is cylindrical and spans the width of the machine, sweeping debris into the hopper.

Check the brush daily for wear or damage. Remove any string or wire tangled on the main brush, main brush drive hub, or main brush idler hub.

Check the main brush pattern weekly. The pattern should be 50 to 75 mm (2 to 3 in) wide with the main brush in the lowered position.

Rotate the main brush end-for-end after every 50 hours of operation for maximum brush life and best sweeping performance.

Replace the main brush when the remaining bristles measure 25 mm (1 in) in length.



### REPLACING MAIN BRUSH

1. Stop the machine, set the parking brake and turn the machine power off.

**FOR SAFETY: Before leaving or servicing machine, stop on level surface, set parking brake, turn off machine, and remove key.**

2. Open the left side main brush access door.

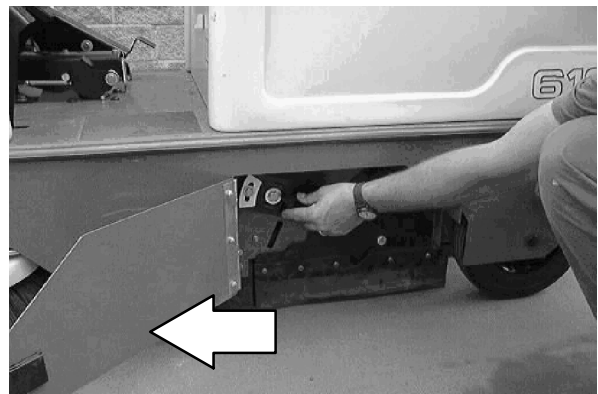

3. Loosen the idler arm mounting knob and three other side skirt mounting knobs. Remove the brush idler arm assembly.





4. Grasp the main brush; pull it off the brush drive plug and out of the main brush compartment.
5. Put the new or rotated end-for-end main brush on the floor next to the access door.
6. Slide the main brush onto the drive plug. Rotate the brush until it engages the drive plug, and push it all the way onto the plug.



7. Check that the recirculation skirt is tucked in behind the frame.
8. Slide the main brush idler arm plug onto the main brush.

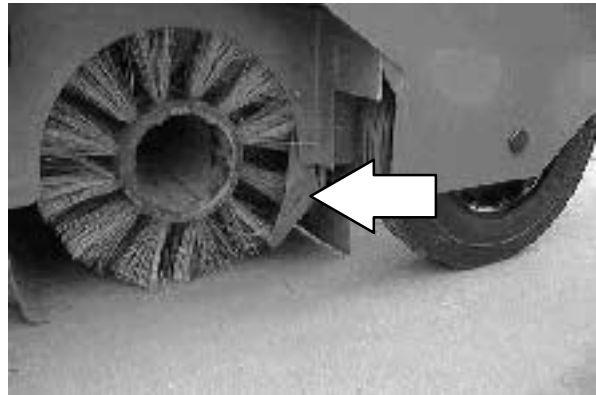

9. Secure the idler arm on the bolts. Hand tighten the mounting knobs.
10. Close the main brush access door.

## CHECKING AND ADJUSTING MAIN BRUSH PATTERN

1. Apply chalk, or some other material that will not blow away easily, to a smooth, level floor.
2. Raise the side brush and main brush and position the main brush over the chalked area.
3. Start and lower the main brush for 15 to 20 seconds while keeping a foot on the brakes to keep the machine from moving.

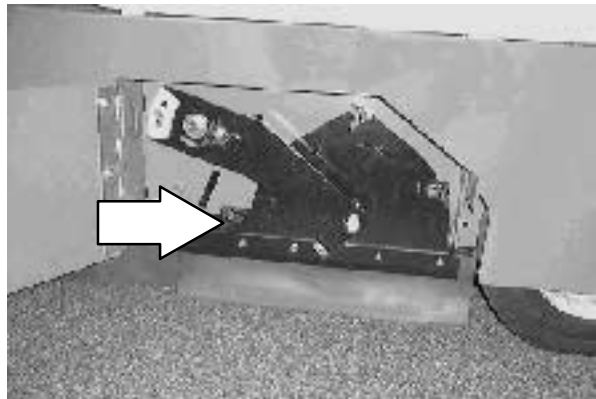

*NOTE: If chalk or other material is not available, allow the brushes to spin on the floor for two minutes. A polish mark will remain on the floor.*

4. Raise the main brush.
5. Drive the machine off the test area.

## MAINTENANCE

6. Observe the width of the brush pattern. The proper brush pattern width is 50 to 75 mm (2 to 3 in).

The brush taper is factory set and should not need adjustment unless parts of the brush system have been replaced.

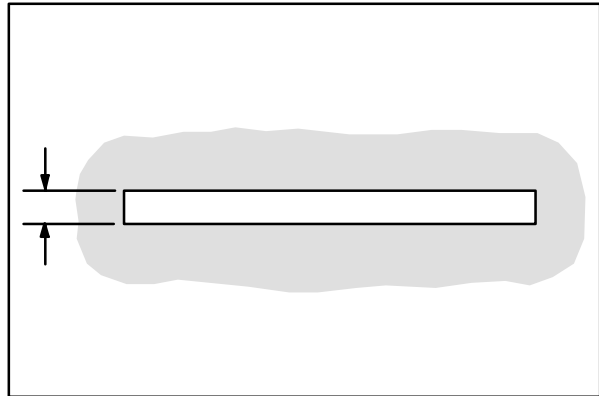

00582

If the main brush pattern is tapered, more than 15 mm (0.5 in) on one end than the other, adjust the taper as follows:

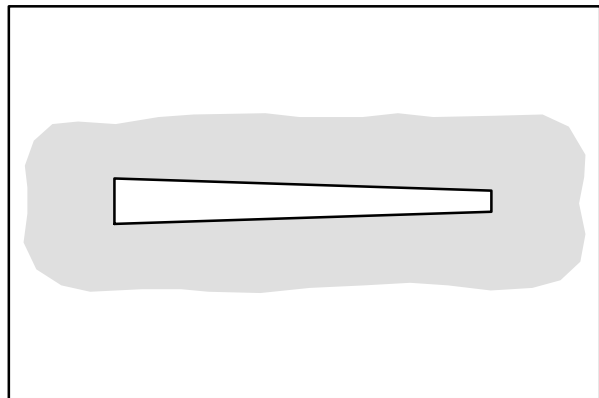

00601

- A. Loosen the brush shaft bearing bracket mounting bolt and the idler arm securing head.
- B. Allow the brush to operate and float into position for approximately 30 seconds.
- C. Tighten the adjustment bolt and idler arm securing knob.
- D. Check the main brush pattern and readjust as necessary.

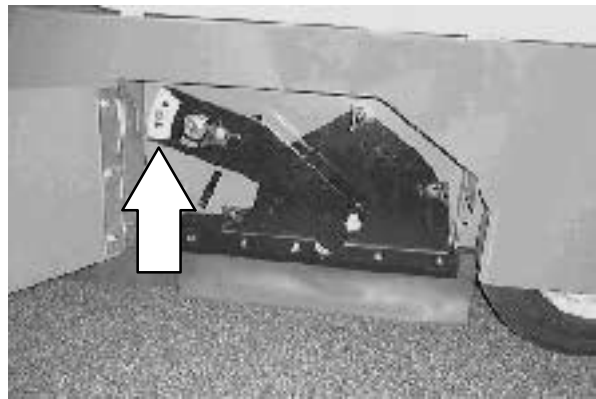

**SIDE BRUSH**

The side brush sweeps debris along edges into the path of the main brush.

Check the brush daily for wear or damage. Remove any string or wire found tangled on the side brush or side brush drive hub.

Check the side brush pattern daily. The side brush bristles should contact the floor in a 10 o'clock to 3 o'clock pattern when the brush is in motion.

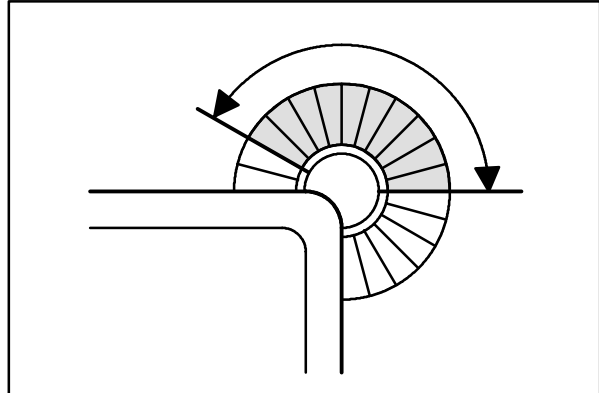

350327

Adjust the side brush pattern by loosening the hex screw located above the side brush pulley. Move the pulley mount bracket up or down to achieve the proper side brush pattern. Retighten the hex screw.

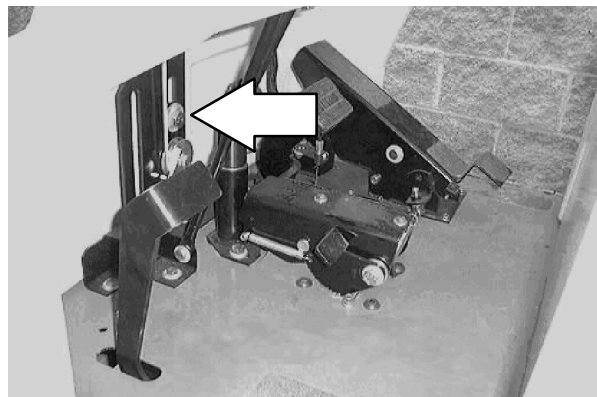

The side brush should be replaced when it no longer sweeps effectively for your application. A guideline length is when the remaining bristles measure 50 mm (2 in) in length. You may need to replace the side brush sooner if you are sweeping light litter or use a brush with shorter bristles if you are sweeping heavy debris.

## MAINTENANCE

### REPLACING SIDE BRUSH

1. Stop the machine, set the parking brake and turn the machine power off.

**FOR SAFETY: Before leaving or servicing machine, stop on level surface, set parking brake, turn off machine, and remove key.**

2. Remove the side brush retaining pin from the side brush drive shaft by pulling the pin keeper off over the end of the pin.
3. Slide the side brush off the side brush drive shaft.
4. Slide the new side brush onto the side brush drive shaft.
5. Insert the side brush retaining pin through the side brush hub and shaft.
6. Secure the pin by clipping the pin keeper over the end of the pin.
7. Adjust the side brush pattern with the side brush pulley mount bracket.



### SIDE BRUSH GUARD

Check the side brush guard after every 200 hours of operation. Replace the brush guard after it begins to show serious wear.



---

**SKIRTS AND SEALS**

---

**REAR SKIRTS**

The two rear skirts are located on the bottom rear of the main brush compartment. The vertical skirt should clear the floor up to 5 mm (0.25 in). The recirculation skirt requires no adjustment.

Check the skirts for wear or damage and adjustment daily.

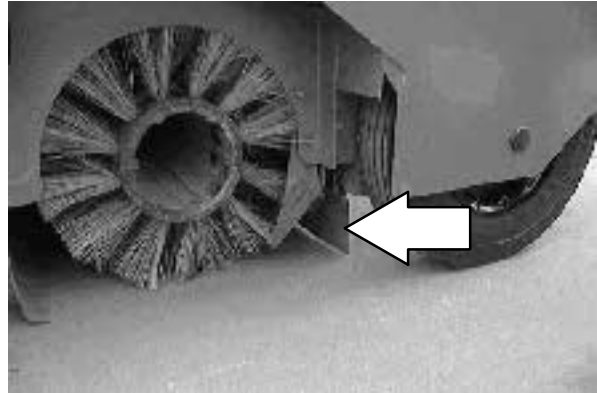

*NOTE: The recirculation skirt must be folded in between the brush and the machine frame before the brush door is mounted for the machine to work properly.*

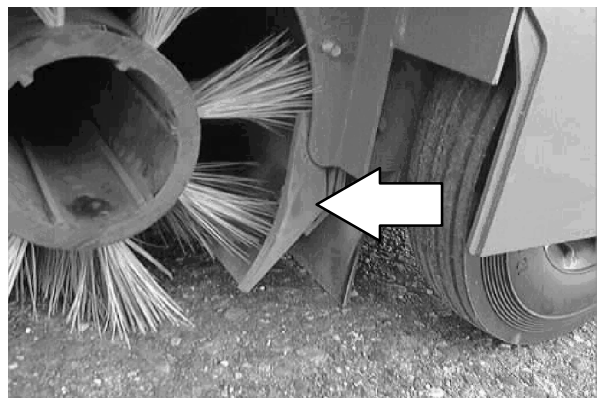
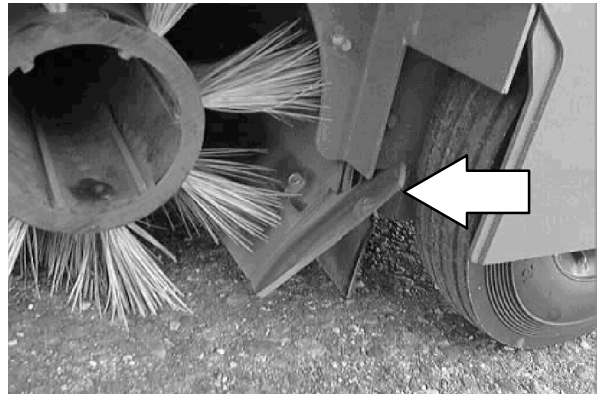

## MAINTENANCE

### SIDE SKIRTS

The side skirts are located on both sides of the main brush compartment. The skirts should clear the floor up to 5 mm.

Check the skirts for wear or damage daily.

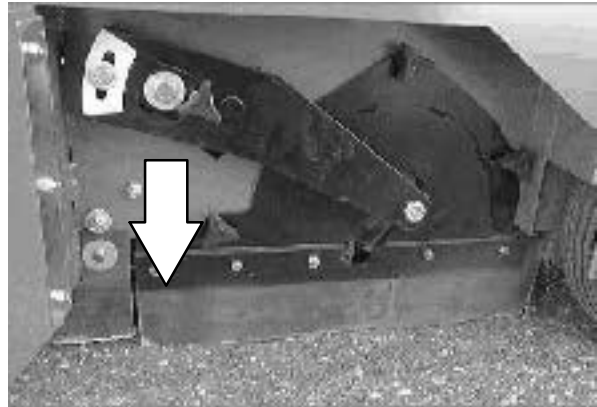

### LARGE DEBRIS TRAP SKIRT

The large debris trap skirt is located along the front of the main brush. This skirt is raised and lowered by the large debris trap pedal, allowing larger debris to be trapped and swept up into the hopper.

Check the skirt for wear or damage after every 100 hours of operation.

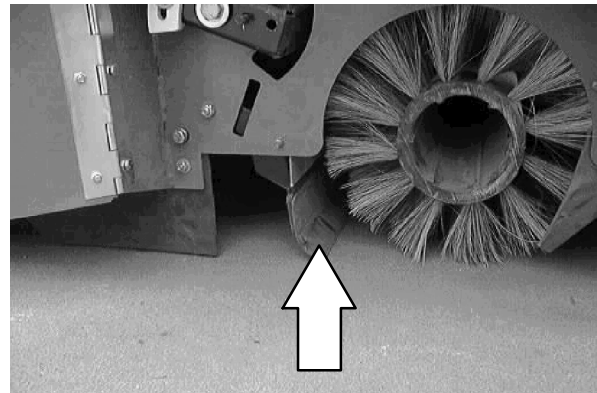

### HOPPER SEALS

The lower hopper seals are located around the back side of the brush compartment. The hopper rests on the seals when the hopper is setting in proper sweeping position.

Check the seals for wear or damage after every 100 hours of operation.

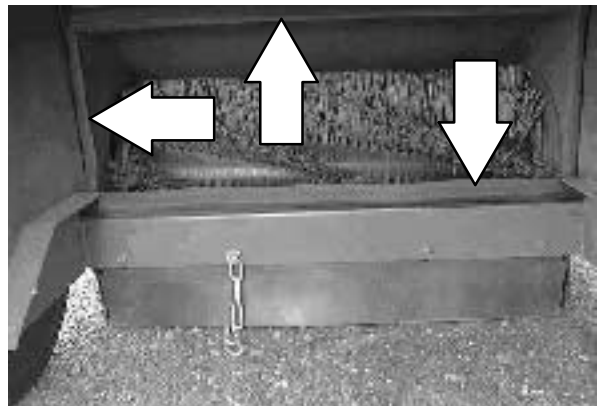

The upper hopper seal is located above the hopper on the bottom of the filter weldment. Check the seal for wear or damage after every 100 hours of operation.

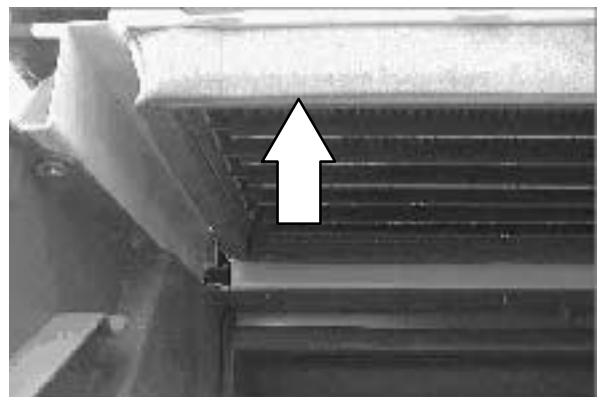

---

**BRAKES AND TIRES**

---

**BRAKES**

The mechanical disc brake is located on the front wheel. The brake is operated by the brake foot pedal.

Check the brake adjustment after every 200 hours of operation. If the brake does not respond well to pressure on the brake pedal, you may need to adjust the brake.

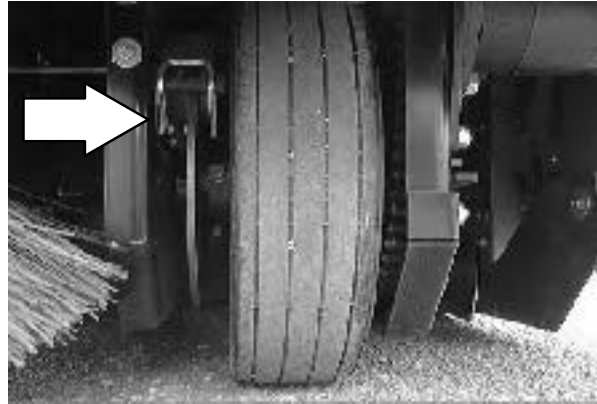

To Adjust Brakes:

Remove the cotter key from the brake extension arm, and position the extension arm in the next adjustment hole in the brake link.



Insert the cotter key back into the brake extension arm, and check the brake for proper operation.



### TIRES

The tires on the machine are solid. Check the tires after every 100 hours of operation for damage.

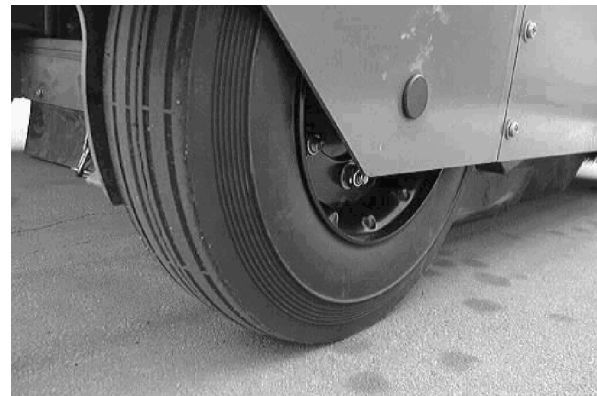



**PUSHING, TOWING, AND TRANSPORTING THE MACHINE**

**PUSHING OR TOWING THE MACHINE**

If the machine becomes disabled, it can be pushed or towed from the front or rear, but it is easier and more stable to tow from the front end.

Only push or tow the machine for a *very short distance* and do not exceed 1.6 kp/h (1 mph). It is NOT intended to be pushed or towed a long distance or at a high speed.

**ATTENTION! Do not push or tow machine for a long distance or damage may occur to the propelling system.**

**TRANSPORTING THE MACHINE**

1. Position the front of the machine at the loading edge of the truck or trailer.

**FOR SAFETY: Use truck or trailer that will support the weight of the machine.**

*NOTE: Empty the hopper before transporting the machine.*

2. If the loading surface is not horizontal or is higher than 380 mm (15 in) from the ground, use a winch to load machine.

If the loading surface is horizontal AND is 380 mm (15 in) or less from the ground, the machine may be driven onto the truck or trailer.

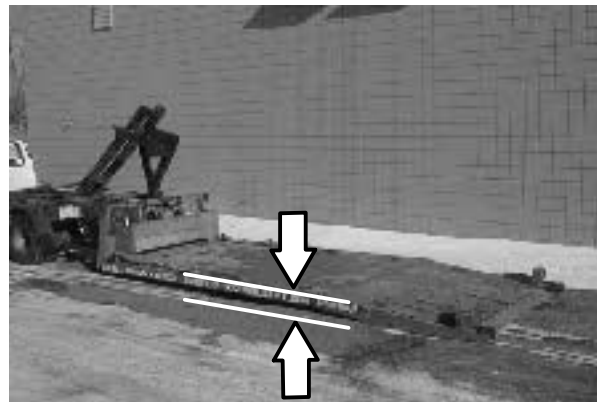

3. To winch the machine onto the truck or trailer, attach the winching chains to the front tie down located in the front of the machine frame.

**FOR SAFETY: When loading machine onto truck or trailer, use winch. Do not drive the machine onto the truck or trailer unless the loading surface is horizontal AND is 380 mm (15 in) or less from the ground.**

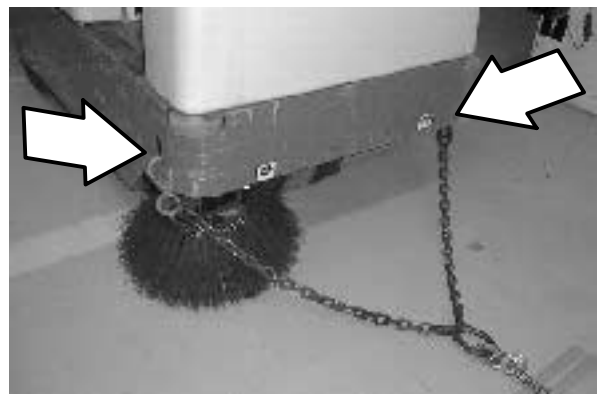

## MAINTENANCE

4. Position the machine onto the truck or trailer as far as possible. If the machine starts to veer off the centerline of the truck or trailer, stop and turn the steering wheel to center the machine.
5. Set the parking brake and block the machine tires. Tie down the machine to the truck or trailer before transporting.

The front tie-down locations are the holes in the front of the machine frame.



The rear tie-down locations are the holes in the sides of the machine frame near the rear bumper.

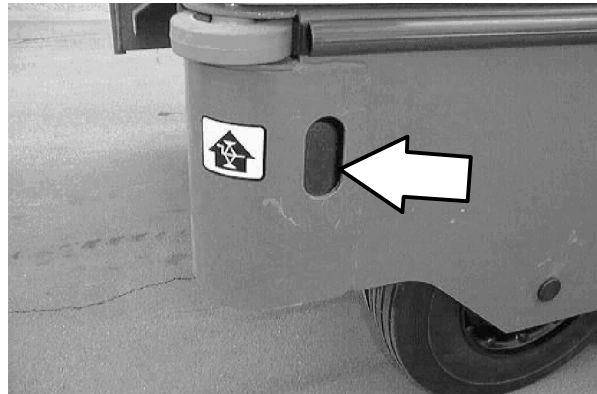

6. If the loading surface is not horizontal or is higher than 380 mm (15 in) from the ground, use a winch to unload machine.

If the loading surface is horizontal AND is 380 mm (15 in) or less from the ground, the machine may be driven off the truck or trailer.

**FOR SAFETY: When unloading machine off truck or trailer, use winch. Do not drive the machine off the truck or trailer unless the loading surface is horizontal AND 380 mm (15 in) or less from the ground.**

---

**MACHINE JACKING**

---

Empty the hopper before jacking the machine. You can jack up the machine for service at the designated locations. Use a hoist or jack that will support the weight of the machine. Always stop the machine on a flat, level surface and block the tires before jacking up the machine.

**FOR SAFETY: Before leaving or servicing machine, stop on level surface, set parking brake, turn off machine, and remove key.**

The front jacking locations are on the flat bottom edge of the front of the machine frame.

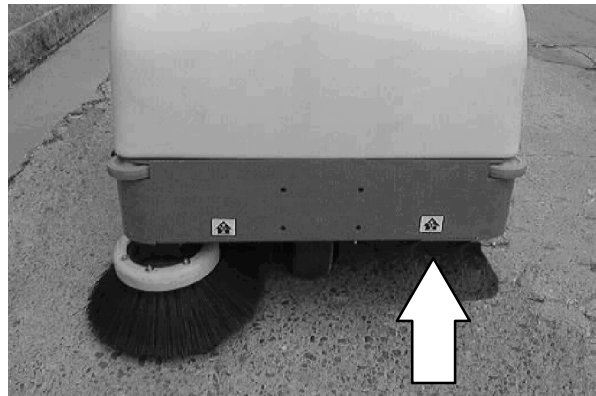

The rear jacking locations are on the corners of the rear frame.

**FOR SAFETY: When servicing machine, block machine tires before jacking up machine.**

**FOR SAFETY: When servicing machine, jack up machine at designated locations only. Block machine up with jack stands.**

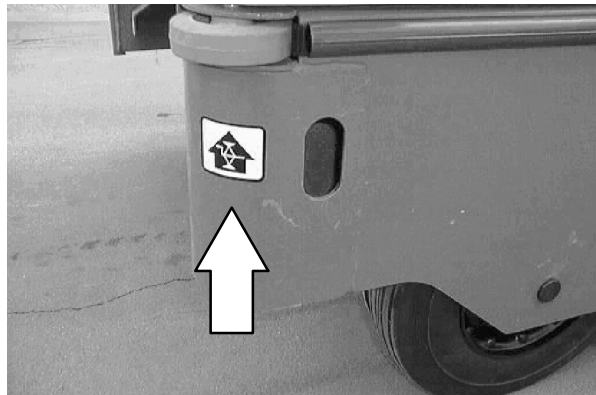

---

**STORING MACHINE**

---

Before storing the machine for an extended time, the machine needs to be serviced to lessen the chance of rust, sludge, and other undesirable deposits from forming.

# SPECIFICATIONS

## SPECIFICATIONS

### GENERAL MACHINE DIMENSIONS/CAPACITIES

Item	Dimension/capacity	
Length	1524 mm	(60 in)
Width	813 mm	(32 in)
Height	1270 mm	(50 in)
Track	880 mm	(35 in)
Wheelbase	682 mm	(27 in)
Main sweeping brush diameter	280 mm	(11 in)
Main sweeping brush length	560 mm	(22 in)
Side brush diameter	406 mm	(16 in)
Sweeping path width	560 mm	(22 in)
Sweeping path width with one side brush	762 mm	(30 in)
Sweeping path width with two side brushes	965 mm	(38 in)
Main sweeping brush pattern width	50 mm	(2 in)
Hopper weight capacity	90 kg	(200 lb)
Hopper volume capacity	85 L	(3 cu ft)
Dust filter area	3.2 sq m	(34 sq ft)
GVWR	458 kg	(1009 lb)

### GENERAL MACHINE PERFORMANCE

Item	Measure	
Maximum forward speed	8 km/h	(5 mph)
Maximum reverse speed	4.8 km/h	(3 mph)
Minimum aisle turn	1830 mm	(72 in)
Minimum turning radius	1725 mm	(68 in)
Maximum rated incline with empty hopper	10° / 17.5%	
Maximum rated incline with full hopper	8° / 14%	

**POWER TYPE**

Engine	Type	Ignition	Cycle	Aspiration	Cylinders	Bore	Stroke
Robin	Piston	Breakerless-type spark	4	Natural	1	84 mm (3.31 in)	61 mm (2.40 in)
	Displacement		Net power, governed		Net power, maximum		
	338 cc (20.6 cu in)		5.4 kw (7.5 hp) @ 2200 rpm		8.2 kw (11 hp) @ 3600 rpm		
	Fuel		Cooling system		Electrical system		
	Gasoline, 87 octane minimum, unleaded. Fuel tank: 6 L (1.5 gal)		Air cooled		12 V nominal		
	LPG, Fuel tank: 9 kg ( 20 lb) Vapor				12.5 A alternator		
	Idle speed		(Fast) governed speed		Firing order		
	2200 rpm (gov)		2200 rpm (gov)		1		
	Spark plug gap		Valve clearance, cold		Engine lubricating oil		
.6 mm (0.024 in) Gasoline and LPG		0.145 to 0.185 mm (0.0057 to 0.0072 in) intake and exhaust		1.20 L (1.3 qt) 10W30 SAE-SG/SH			

**STEERING**

Type	Power source	Emergency steering
Front wheel, manual controlled	Manual steering	Manual

**HYDRAULIC SYSTEM**

System	Capacity	Fluid Type
Hydraulic reservoir	7.58 L (2 gal)	TENNANT part no. 65869-above 7° C (45° F)
Hydraulic total	9.48 L (2.5 gal)	

**BRAKING SYSTEM**

Type	Operation
Service brakes	Mechanical disc brake (1), one front wheel, cable actuated
Parking brake	Utilizes service brakes, cable actuated

**TIRES**

Location	Type	Size
Front (1)	Solid	90 x 305 mm (3.5 in x12 in OD)
Rear (2)	Solid	76 x 305 mm (3 in x 12 in OD)

# SPECIFICATIONS

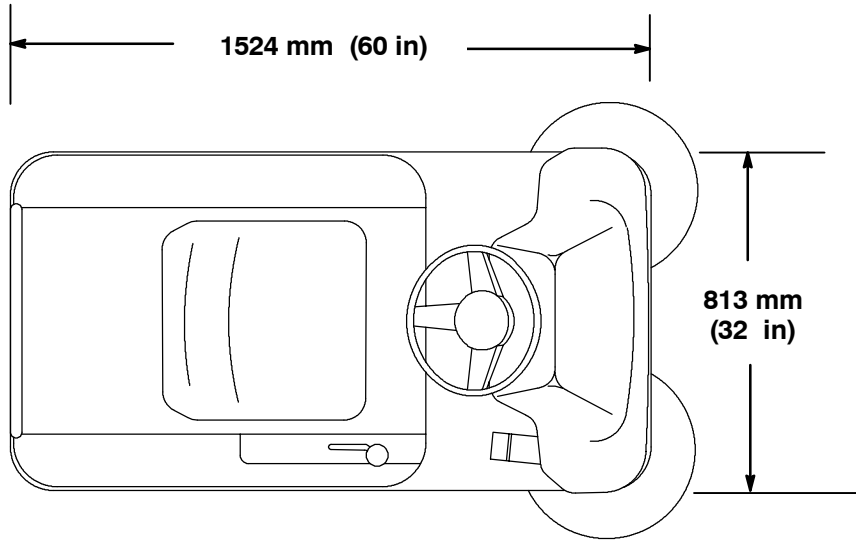

TOP VIEW

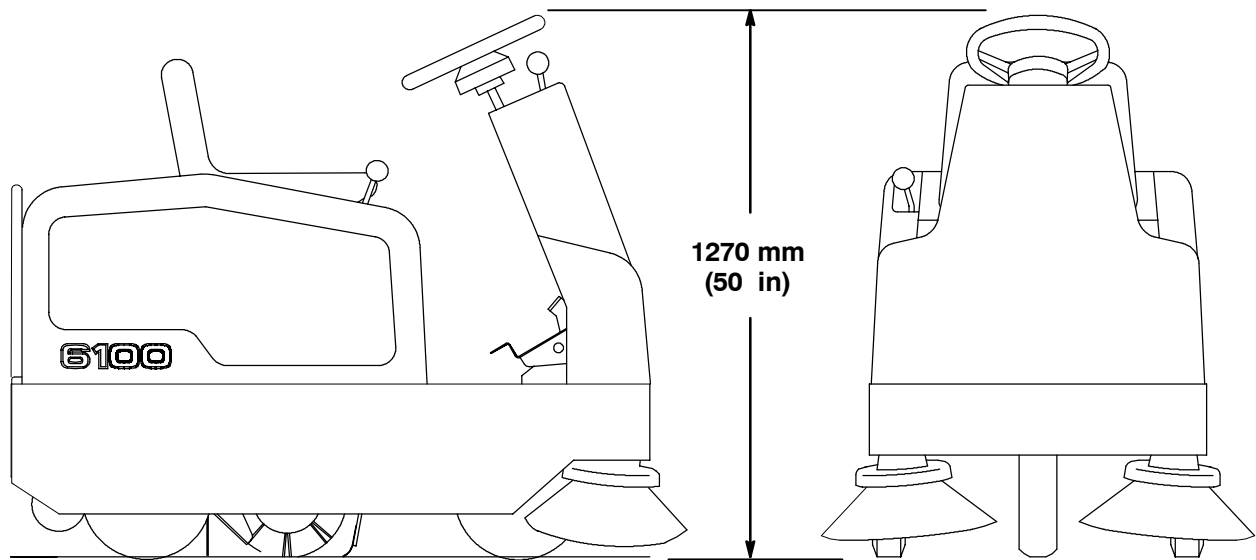

SIDE VIEW

FRONT VIEW

## MACHINE DIMENSIONS

352185

**A**

Air filter, 18  
 Air filter, 42  
   Filter element, 42  
   Precleaner element, 42  
 Aisle turn, 66

**B**

Batteries  
   Charger specifications, 67  
   Specifications, 67  
 Battery, 44  
 Belts, 45  
   Hydraulic pump, 46  
   Jackshaft, 46  
   Main brush, 45  
   Vacuum Fan, 45  
 Brake adjustment, 61  
 Brake pedal, 9  
 Brakes, 19, 61  
   System specifications, 67  
 Brush adjustments, 32  
 Brush door seals, 60  
 Brushes, 25–28, 32, 54–59  
   Adjusting main brush taper, 56  
   Checking main brush pattern, 55–57  
   Checking side brush pattern, 57  
   Door seals, 60  
   Main brush, 25, 54–57  
   Main brush bristle length, 54  
   Main brush lever, 10  
   Rear skirts, 59  
   Replacing main brush, 54–56  
   Replacing side brush, 58  
   Side brush, 26, 57–59  
   Side brush bristle length, 57  
   Side brush guard, 58  
   Side brush lever, 13  
 Button, Horn, 13

**C**

Capacities, 66  
 Carburetor, 44  
 Chains, 45  
   Propelling, 38, 47  
   Static drag, 47  
   Steering gear, 39, 47

Changing LPG fuel tank, 20–22  
 Charging system light, 10  
 Circuit breakers, 15  
 Cleaning carpet, 25  
 Control panel  
   Hourmeter, 12  
   Operating lights switch, 14  
   Operating/hazard lights switch, 14  
 Controls, 7  
   Brake pedal, 9  
   Charging system light, 10  
   Circuit breakers, 15  
   Directional pedal, 8  
   Engine choke knob, 11  
   Engine oil pressure light, 10  
   Fuel level gauge, 11  
   Fuse, 15  
   Horn button, 13  
   Hourmeter, 12  
   Large debris trap pedal, 9  
   Main brush lever, 10  
   On-off key switch, 13  
   Operating lights switch, 14  
   Operating/hazard lights switch, 14  
   Operation, 8  
   Parking brake pedal, 9  
   Side brush lever, 13  
   Steering wheel, 12  
   Symbols, 6–8  
   Vacuum fan/Filter shaker switch, 12

**D**

Debris hopper, 48–50  
 Dimensions, 66  
 Directional pedal, 8  
 Doors, Brush, Seals, 60  
 Dust filter  
   Changing, 49–51  
   Cleaning, 48

**E**

Electric motors, 67  
 Electrical  
   Circuit breakers, 15  
   Fuse, 15  
   On-off key switch, 13

Emptying the hopper, 31–34  
Engine choke knob, 11  
Engine lubrication, 38  
Engine oil level, 19  
Engine oil pressure light, 10

**F**

Filter , Air, 42  
Fuel level gauge, 11, 19  
Fuel lines, 43  
Fuel screen, 43  
Fuel tank, Changing LPG, 20–22  
Fuses, 15

**G**

Gauges, Fuel level, 11

**H**

Hopper  
  Changing dust filter, 49–51  
  Cleaning dust filter, 48  
  Debris, 48–50  
  Dust filter, 48–50  
  Emptying the hopper, 31–34  
  Seals, 60  
Hopper , 17  
Hopper filter, 48–50  
Hopper seals, 60  
Horn button, 13  
Hourmeter, 12  
How the machine works, 18  
Hydraulic fluid, 41  
Hydraulic fluid reservoir, 40  
Hydraulic hoses, 41  
Hydraulic pump , Belt, 46  
Hydraulic pump belt, 46  
Hydraulic system, 67  
Hydraulics, 40–44  
  Fluid, 41–43  
  Fluid filter, 40  
  Fluid level, 40  
  Hoses, 41  
  Reservoir, 40

**J**

Jack points, 65  
Jacking up the machine, 65  
Jackshaft, Belt, 46  
Jackshaft belt, 46

**L**

Large debris trap pedal, 9  
Large debris trap skirt, 60  
Leaking fluid, 18  
Levers  
  Main brush, 10  
  Side brush, 13  
Lights  
  Charging system, 10  
  Engine oil pressure, 10  
  Operating lights switch, 14  
  Operating/hazard lights switch, 14  
Lower hopper seals, 60  
LPG, Changing the fuel tank, 20–22  
LPG odor, 19  
LPG tank, Frosted components, 19  
Lubrication, 38–40  
  Engine, 38  
  Propelling system, 38, 47  
  Steering castor pivot bearing, 39  
  Steering gear chain, 39, 47

**M**

Machine, Troubleshooting, 35  
Machine components, 5  
Machine dimensions, 68  
Machine jacking, 65  
Machine tie down location, 64  
Main brush, 25, 54–57  
  Adjust brush taper, 56  
  Belt, 45  
  Bristle length, 54  
  Checking brush pattern, 55–57  
  Door seals, 60  
  Hopper seals, 60  
  Maintenance, 54  
  Rear skirts, 59  
  Replacing, 54–56  
  Sand wedge, 25



Main brush , Natural fiber, 25  
 Main brush belt, 45  
 Main brush lever, 10  
 Maintenance, 36  
   Intervals, 36–38  
   Recommended, 4  
 Maintenance chart, 36–38  
 Motors, Electric, 67

**N**

Natural fiber main brush, 25

**O**

On-off key switch, 13  
 Operating lights switch, 14  
 Operating/hazard lights switch, 14  
 Operation on inclines, 24  
 Operator Responsibility, 4  
 Operator Seat, 16  
 Operator seat, 16  
 Option, Operator seat, Adjustment, 16  
 Options, 33–35  
   Operating lights switch, 14  
   Operating/hazard lights switch, 14  
   QuickMop, 33

**P**

Parking brake pedal, 9  
 Pedal, Directional, 8  
 Pedals  
   Brake, 9  
   Large debris trap pedal, 9  
   Parking brake, 9  
 Post-operation checklist, 32  
 Pre-operation checklist, 18  
 Propelling system, 38, 47  
 Pushing machine, 63  
 Pushing or towing the machine, 63  
 Pushing, towing, and transporting machine, 63

**Q**

QuickMop™ Option, 33

**R**

Rear skirts, 59  
 Recirculation skirt, Tucking in skirt, 55, 59

**S**

Operation, 4  
   Hopper , 17  
   QuickMop, 33  
 Safety  
   Labels, 3  
   Precautions, 2–4  
 Sand wedge main brush, 25  
 Seals, 59–62  
   Brush doors, 60  
 Seat  
   Adjustment, 16  
   Operator, 16  
 Service records, 32  
 Side brush, 26, 57–59  
   Bristle length, 57  
   Checking brush pattern, 57  
   Guard, 58  
   Lever, 13  
   Replacing, 58  
 Side brush guard, 58  
 Side brush lever, 13  
 Skirts, 32, 59–62  
   Large debris trap, Seals, 60  
   Rear, 59  
 Spark plugs, 44  
 Specifications, 66–69  
   Braking system, 67  
   Chargers, 67  
   Electric motors, 67  
   Machine capacities, 66  
   Machine dimensions, 66  
   Machine performance, 66  
   Power type, 67  
   Steering, 67  
   Tires, 67  
 Starting the machine, 22  
 Static drag chain, 47

Steering, 19  
  Specifications, 67  
Steering castor pivot bearing, 39  
Steering gear chain, 39, 47  
Steering wheel, 12  
Stop sweeping, 28  
Stop the machine, 29  
Storing machine, 65  
Sweeping, 26  
Sweeping and brush information, 25–28  
Switch, Vacuum fan/Filter shaker, 12  
Switches  
  On-off key, 13  
  Operating lights, 14  
  Operating/hazard lights, 14  
Systems, Hydraulic, 67

### T

Thermo Sentry, 53  
Tie down location, 64  
Tires, 61, 62  
  Specifications, 67  
Towing machine, 63  
Transporting machine, 63  
Transporting the machine, 63  
Travel speed, 66  
Troubleshooting, 35

### U

Upper hopper seals, 60

### V

Vacuum fan, Belt, 45  
Vacuum fan belt, 45  
Vacuum Fan/Filter shaker switch, 12