



# 5700

(Electric)

(000000-029999)

## Walk-Behind Scrubber Operator Manual

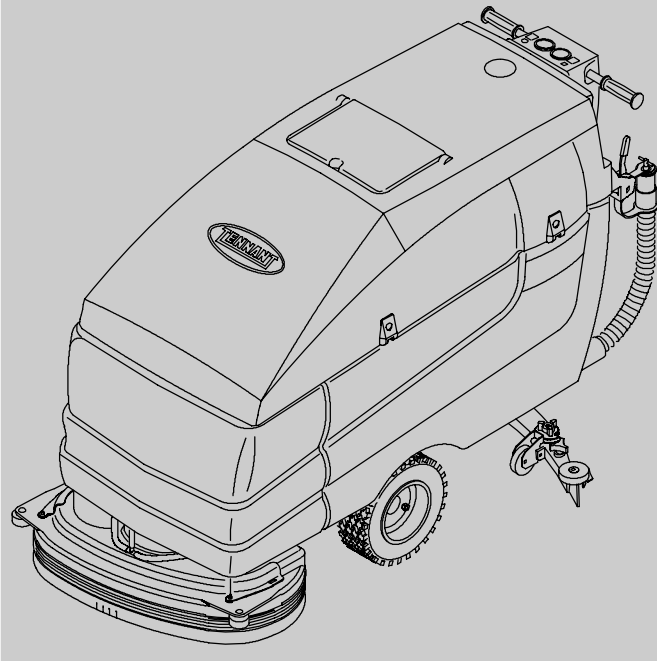

***FaST***  
Foam Scrubbing Technology  
The Safe Scrubbing Alternative®

**ES® Extended Scrub System**

**North America / International**

[www.tennantco.com](http://www.tennantco.com)

**MM400**  
Rev. 20 (09-2006)





This manual is furnished with each new model. It provides necessary operation and maintenance instructions.

**Read this manual completely and understand the machine before operating or servicing it.**

This machine will provide excellent service. However, the best results will be obtained at minimum costs if:

- The machine is operated with reasonable care.
- The machine is maintained regularly - per the machine maintenance instructions provided.
- The machine is maintained with manufacturer supplied or equivalent parts.

	<b>PROTECT THE ENVIRONMENT</b> Please dispose of packaging materials, old machine components such as batteries, hazardous fluids such as antifreeze and oil, in an environmentally safe way according to local waste disposal regulations.
	Always remember to recycle.

<b>MACHINE DATA</b>	
Please fill out at time of installation for future reference.	
Model No. -	_____
Serial No. -	_____
Machine Options -	_____
Sales Rep. -	_____
Sales Rep. phone no. -	_____
Customer Number -	_____
Installation Date -	_____

**Tennant Company**

PO Box 1452

Minneapolis, MN 55440

Phone: (800) 553-8033 or (763) 513-2850

[www.tennantco.com](http://www.tennantco.com)

Specifications and parts are subject to change without notice.

Copyright © 1998-2000, 2002-2006 TENNANT, Printed in U.S.A.

**CONTENTS**

	Page		Page
SAFETY PRECAUTIONS .....	3	MAINTENANCE .....	52
OPERATION .....	5	MAINTENANCE CHART .....	52
OPERATOR RESPONSIBILITY .....	5	LUBRICATION .....	54
MACHINE COMPONENTS .....	6	REAR CASTERS .....	54
CONTROL PANEL SYMBOLS .....	7	TRANSAXLE .....	54
CONTROLS AND INSTRUMENTS .....	8	BATTERIES .....	54
STEERING HANDLES .....	9	CHARGING THE BATTERIES .....	55
SOLUTION FLOW LEVER .....	10	ELECTRIC MOTORS .....	57
POWER WAND SWITCH (OPTION) ..	10	SCRUB HEAD .....	58
FaST SWITCH (OPTION) .....	11	DISK BRUSH SCRUB HEAD SKIRT ..	58
RECOVERY TANK FULL LIGHT .....	11	ADJUSTING THE SCRUB	
ES SWITCH (OPTION) .....	12	HEAD SKIRT .....	58
BATTERY DISCHARGE INDICATOR ..	12	REPLACING THE SCRUB	
BRUSH PRESSURE GAUGE .....	12	HEAD SKIRT .....	59
SCRUB BRUSHES DOWN LIGHT ....	13	CYLINDRICAL BRUSH SCRUB	
SCRUB BRUSHES SWITCH .....	13	HEAD SKIRTS .....	60
HOURMETER .....	14	ADJUSTING THE SCRUB	
MACHINE ON LIGHT .....	14	HEAD SKIRTS .....	60
ON-OFF KEY SWITCH .....	14	REPLACING THE SCRUB	
SQUEEGEE LEVER .....	15	HEAD SKIRTS .....	60
SPEED REDUCTION KNOB (OPTION)	15	REMOVING OR REPLACING THE	
POWER KILL SWITCH (OPTION) ....	15	SCRUB HEAD .....	61
CIRCUIT BREAKERS .....	16	SCRUB HEAD/CIRCUIT BREAKERS ..	61
FUSES (OPTION) .....	17	LEVELING THE SCRUB HEAD .....	63
SOLUTION TANK HOSE .....	17	SCRUB BRUSHES .....	65
RECOVERY TANK DRAIN HOSE ....	18	DISK BRUSHES .....	65
SUPPORT ARM .....	18	REPLACING THE DISK BRUSHES	65
STOP ARM .....	18	CYLINDRICAL BRUSHES .....	67
SQUEEGEE DOWN PRESSURE		REPLACING THE CYLINDRICAL	
CAMS .....	19	BRUSHES .....	67
SQUEEGEE LEVELING KNOB .....	19	CHECKING AND ADJUSTING	
PARKING BRAKE (OPTION) .....	19	CYLINDRICAL BRUSH	
HOW THE MACHINE WORKS .....	20	PATTERN .....	68
FaST SCRUBBING SYSTEM (OPTION) ..	21	SOLUTION SYSTEM .....	70
PRE-OPERATION CHECKLIST .....	22	RECOVERY TANK .....	70
INSTALLING FaST PAK AGENT (OPTION)	23	SOLUTION TANK .....	71
STARTING THE MACHINE .....	25	FaST SYSTEM (OPTION) .....	72
FILLING THE TANKS .....	25	FaST SYSTEM FILTER SCREEN ..	72
NORMAL SCRUBBING .....	28	FaST SUPPLY HOSE CONNECTOR	72
DOUBLE SCRUBBING .....	31	FaST SYSTEM AIR PUMP FILTER	72
STOP SCRUBBING .....	32	SQUEEGEE .....	73
DRAINING AND CLEANING THE TANKS	33	REMOVING THE SQUEEGEE	
STOP THE MACHINE .....	38	ASSEMBLY .....	73
OPERATION ON INCLINES .....	38	INSTALLING THE SQUEEGEE	
POST-OPERATION CHECKLIST .....	39	ASSEMBLY .....	74
MACHINE TROUBLESHOOTING .....	40	LEVELING THE SQUEEGEE .....	74
OPTIONS .....	42	ADJUSTING SQUEEGEE BLADE	
VACUUM WAND .....	42	DEFLECTION .....	75
POWER WAND .....	46	ADJUSTING THE SQUEEGEE GUIDE	
		ROLLERS .....	76
		SQUEEGEE BLADES .....	76
		REPLACING OR ROTATING THE	
		REAR SQUEEGEE BLADE ....	76
		REPLACING OR ROTATING THE	
		FRONT SQUEEGEE BLADE ...	77

# CONTENTS

---

	Page
BELTS AND CHAINS .....	79
BRUSH DRIVE BELT .....	79
STATIC DRAG CHAIN .....	79
TIRES .....	80
PUSHING AND TRANSPORTING THE MACHINE .....	80
PUSHING THE MACHINE .....	80
TRANSPORTING THE MACHINE ....	81
MACHINE JACKING .....	83
STORAGE INFORMATION .....	83
FREEZE PROTECTION .....	83
SPECIFICATIONS .....	84
GENERAL MACHINE DIMENSIONS/CAPACITIES .....	84
FaST SYSTEM (OPTION) .....	85
GENERAL MACHINE PERFORMANCE ..	85
POWER TYPE .....	86
TIRES .....	86
MACHINE DIMENSIONS .....	87
INDEX .....	88

## SAFETY PRECAUTIONS

The following symbols are used throughout this manual as indicated in their description:



**WARNING:** To warn of hazards or unsafe practices that could result in severe personal injury or death.

**FOR SAFETY:** To identify actions that must be followed for safe operation of equipment.

This machine is designed solely for scrubbing dirt and dust in an indoor environment. Tennant does not recommend using this machine in any other environment.

The following information signals potentially dangerous conditions to the operator or equipment. Read this manual carefully. Know when these conditions can exist. Locate all safety devices on the machine. Then, take necessary steps to train machine operating personnel. Report machine damage or faulty operation immediately. Do not use the machine if it is not in proper operating condition.



**WARNING:** Batteries emit hydrogen gas. Explosion or fire can result. Keep sparks and open flame away. Keep covers open when charging.



**WARNING:** Flammable materials can cause an explosion or fire. Do not use flammable materials in tank(s).



**WARNING:** Flammable materials or reactive metals can cause an explosion or fire. Do not pickup.

**FOR SAFETY:**

1. **Do not operate machine:**
  - Unless trained and authorized.
  - Unless operation manual is read and understood.
  - In flammable or explosive areas unless designed for use in those areas.
2. **Before starting machine:**
  - Make sure all safety devices are in place and operate properly.
  - Check brakes and steering for proper operation (if so equipped).

3. **When using machine:**
  - Go slow on inclines and slippery surfaces.
  - Use care when backing machine.
  - Follow mixing and handling instructions on chemical containers.
4. **Before leaving or servicing machine:**
  - Stop on level surface.
  - Set parking brake (if equipped).
  - Turn off machine and remove key.
5. **When servicing machine:**
  - Avoid moving parts. Do not wear loose jackets, shirts, or sleeves when working on machine.
  - Block machine tires before jacking machine up.
  - Jack machine up at designated locations only. Block machine up with jack stands.
  - Use hoist or jack that will support the weight of the machine.
  - Wear eye and ear protection when using pressurized air or water.
  - Disconnect battery connections before working on machine.
  - Avoid contact with battery acid.
  - Use Tennant supplied or equivalent replacement parts.
6. **When loading/unloading machine onto/off truck or trailer:**
  - Turn off machine.
  - Use truck or trailer that will support the weight of the machine.
  - Use winch. Do not push the machine onto/off the truck or trailer unless the load height is 380 mm (15 in) or less from the ground.
  - Set parking brake after machine is loaded (option).
  - Block machine tires.
  - Tie machine down to truck or trailer.

# SAFETY PRECAUTIONS

The safety labels appear on the machine in the locations indicated. If these or any label becomes damaged or illegible, install a new label in its place.

**FLAMMABLE MATERIALS LABEL - LOCATED ON THE UNDERSIDE OF THE SOLUTION TANK COVER.**



**FOR SAFETY LABEL - LOCATED ON THE OPERATOR CONSOLE.**

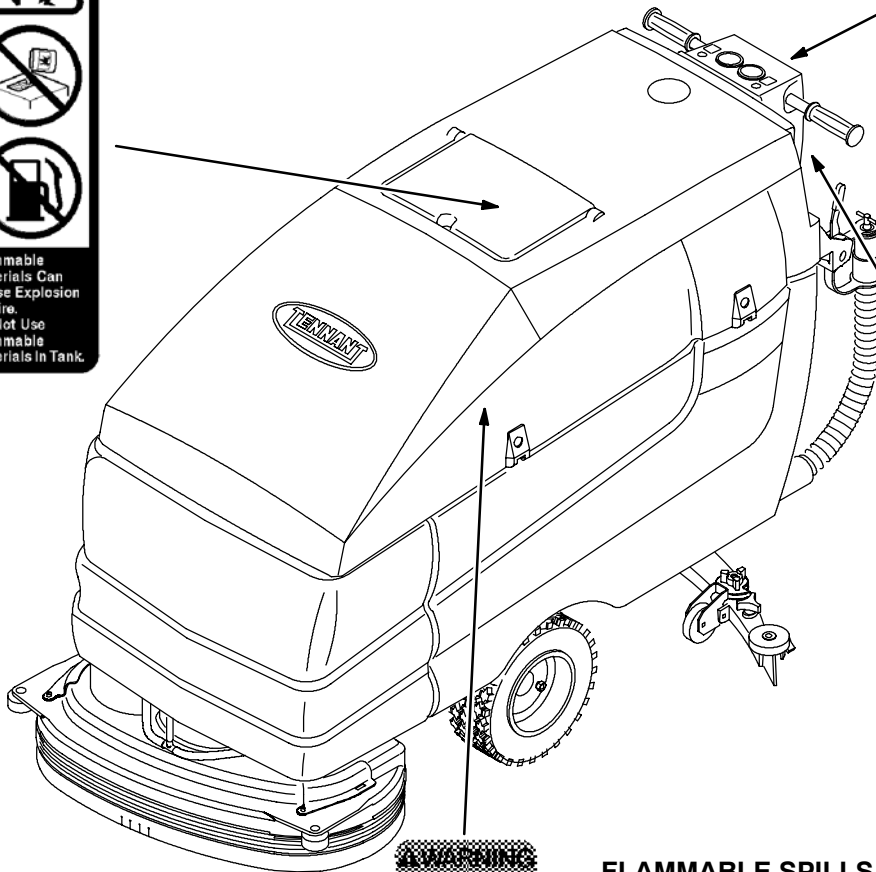

10066



**FLAMMABLE SPILLS LABEL - LOCATED ON THE OPERATOR CONSOLE.**



**BATTERY CHARGING LABEL - LOCATED ON THE UNDERSIDE OF THE SOLUTION TANK.**

## OPERATION

---

**OPERATOR RESPONSIBILITY**

---

- The operator's responsibility is to take care of the daily maintenance and checkups of the machine to keep it in good working condition. The operator must inform the service mechanic or supervisor when the maintenance intervals are required as stated in the MAINTENANCE section of this manual.
- Read this manual carefully before operating this machine.

**FOR SAFETY: Do not operate machine, unless operation manual is read and understood.**

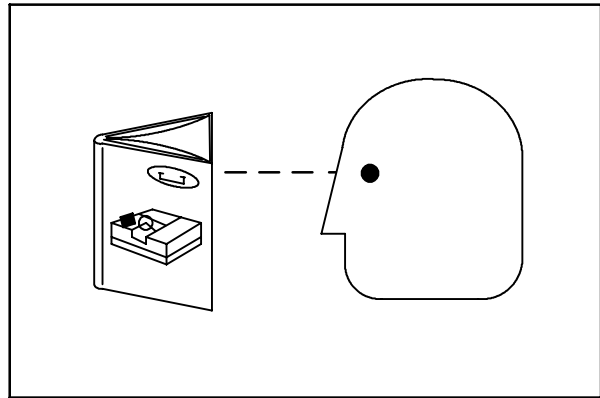

07324

- Check the machine for shipping damage. Check to make sure the machine is complete per shipping instructions.
- Keep your machine regularly maintained by following the maintenance information in this manual. We recommend taking advantage of a regularly scheduled service contract from your Tennant representative.
- Order parts and supplies directly from your authorized Tennant representative. Use the parts manual provided when ordering parts.
- After operation, follow the recommended daily and hourly procedures stated in the *MAINTENANCE CHART*.

# OPERATION

## MACHINE COMPONENTS

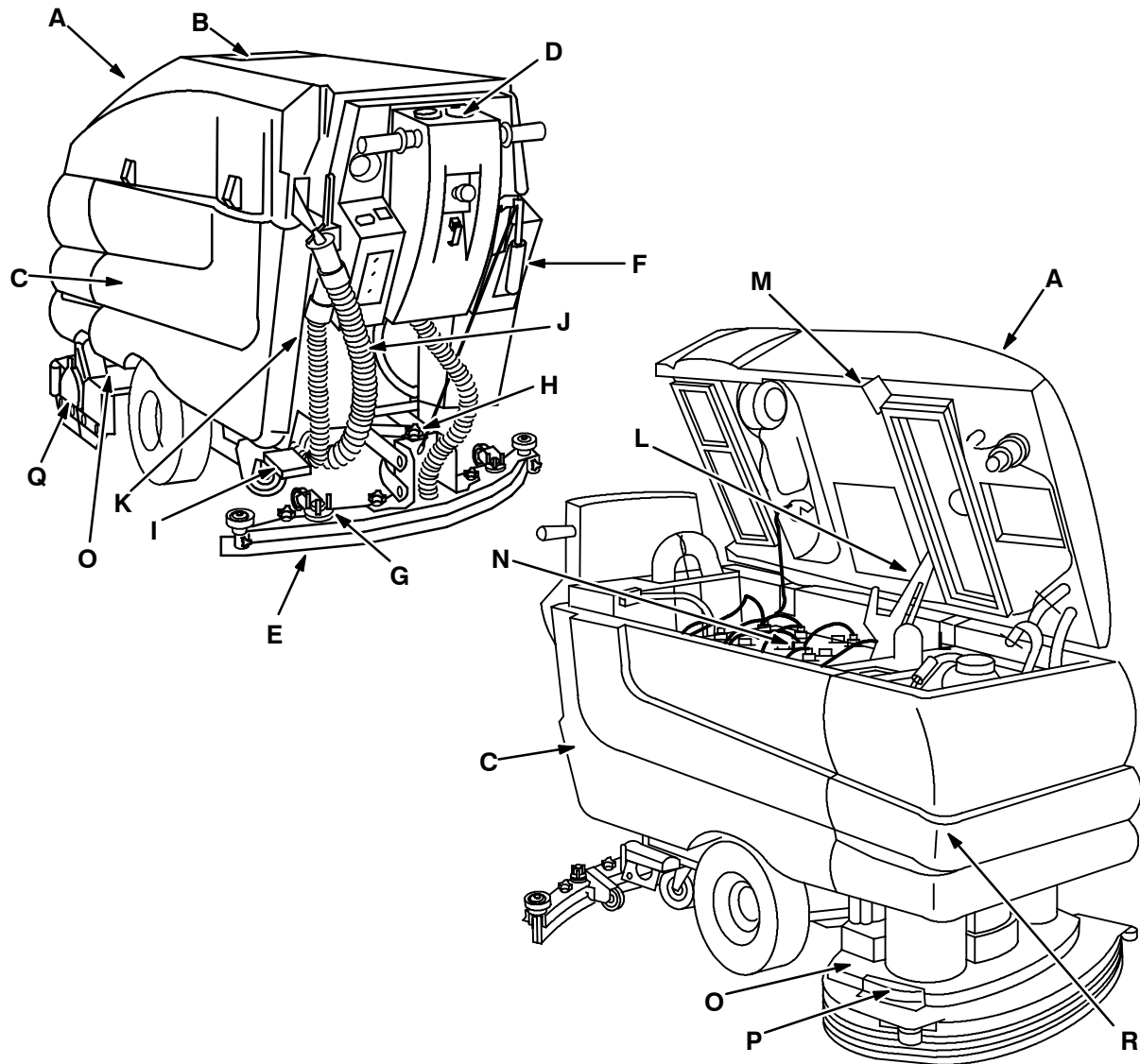

- A. Solution tank
- B. Solution tank fill opening
- C. Recovery tank
- D. Console panel
- E. Squeegee
- F. Squeegee lever
- G. Squeegee down pressure cams
- H. Squeegee leveling knob
- I. Parking brake (option)
- J. Recovery tank drain hose
- K. Solution tank hose
- L. Support arm
- M. Stop arm
- N. Batteries
- O. Scrub head
- P. Scrub brush access cover
- Q. Scrub brush idler door
- R. FaST solution system (option)

10344  
10343



**CONTROL PANEL SYMBOLS**

These symbols identify controls and displays on the machine:

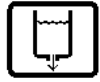

Solution flow



Key switch



Power wand



Variable flow or rate



ES (Extended Scrub)



Circuit breaker #1



Recovery tank full



Circuit breaker #2



Scrub brushes down and on



Circuit breaker #3



Scrub brushes up and off



Circuit breaker #4

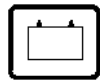

Battery charge



Circuit breaker #5



Scrub brush pressure



Circuit breaker #6

# OPERATION

## CONTROLS AND INSTRUMENTS

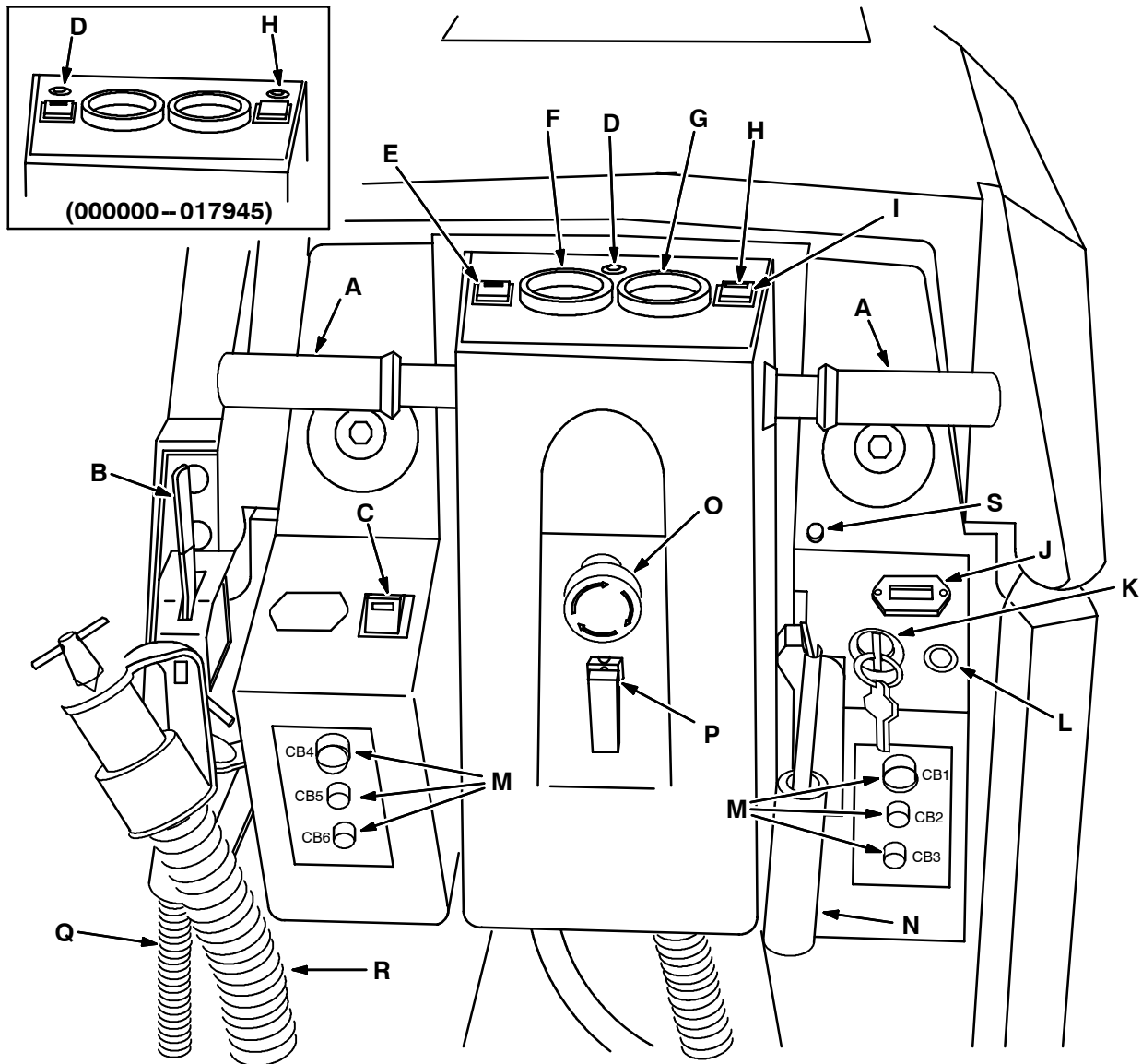

10345

- A. Steering handles
- B. Solution flow lever
- C. FaST switch (option) or Power wand switch (option)
- D. Recovery tank full light
- E. ES switch (option)
- F. Battery discharge indicator
- G. Brush pressure gauge
- H. Scrub brushes down light
- I. Scrub brushes switch
- J. Hourmeter
- K. On-off key switch
- L. Machine on light
- M. Circuit breakers
- N. Squeegee lever
- O. Power kill switch (option)
- P. Steering height adjustment latch
- Q. Solution tank hose
- R. Recovery tank drain hose
- S. Speed reduction knob (option)

**STEERING HANDLES**

The steering handles control the machine speed and direction.

**Forward:** Rotate the handles forward. The further forward you rotate the handles, the faster the machine will go.

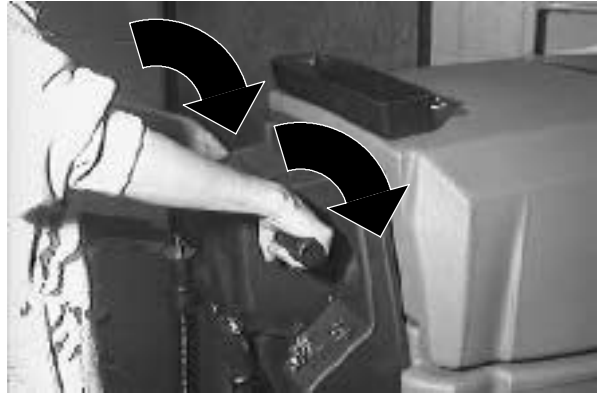

**Backward:** Rotate the handles toward you.



**Turning:** Push the machine in the direction of the turn with the steering handles. The machine will turn on the swivel casters.



**Stopping:** Release the handles.



## OPERATION

The steering handles and console height is adjustable.

**Adjust:** Pull up on the height adjustment latch, move the console up or down to the desired height. Then push down the latch to lock the console in position.

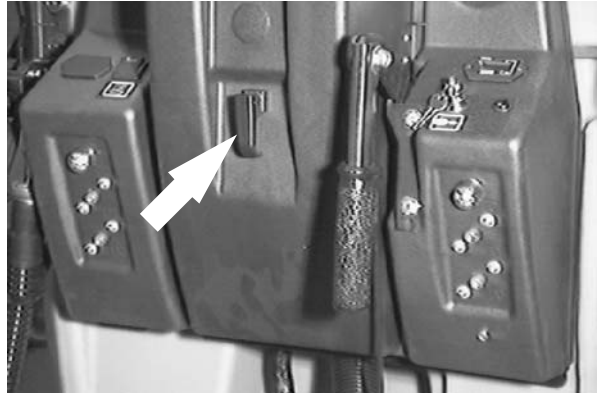

### SOLUTION FLOW LEVER

The solution flow lever controls the amount of solution flow to the floor.

**Increase:** Push the lever forward.

**Decrease:** Pull the lever backward.

*NOTE: A solenoid valve dispenses the solution to the scrub head. The valve opens when the steering handles are rotated forward, and closes when the steering handles are released in neutral position.*

*NOTE: When using the FaST system (option), the solution flow lever is nonfunctional. The FaST system flow rate is pre-set.*

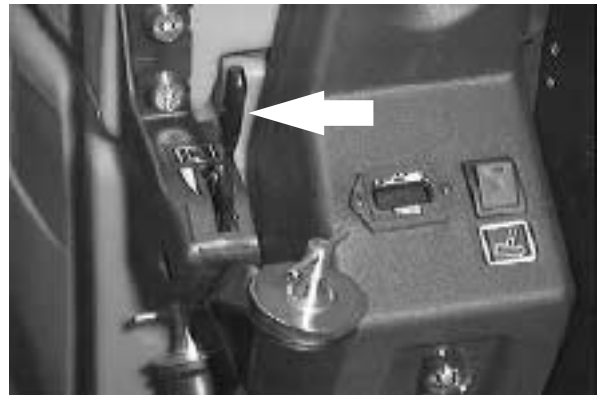

### POWER WAND SWITCH (OPTION)

The power wand switch turns on and off the power wand solution system.

**On:** Press the top of the switch. The switch will light up.

**Off:** Press the bottom of the switch.



### FaST SWITCH (OPTION)

The FaST switch (option) enables the FaST (Foam Scrubbing Technology) system. When the FaST system is enabled, it is turned on and off with the scrub switch.

Enable the FaST system: Press the top of the FaST switch.

Enable conventional scrubbing: Press the bottom of the FaST switch.

*NOTE: Disable the FaST system before using the machine for conventional scrubbing.*

*NOTE: The FaST system will not start until the steering handles are rotated forward or backward.*

*NOTE: Do not enable the FaST system with conventional cleaning detergents in the solution tank. Drain, raise and refill the solution tank with clear cool water only before operating the FaST system. Conventional cleaning detergents/restorers may cause failure to the FaST solution system.*

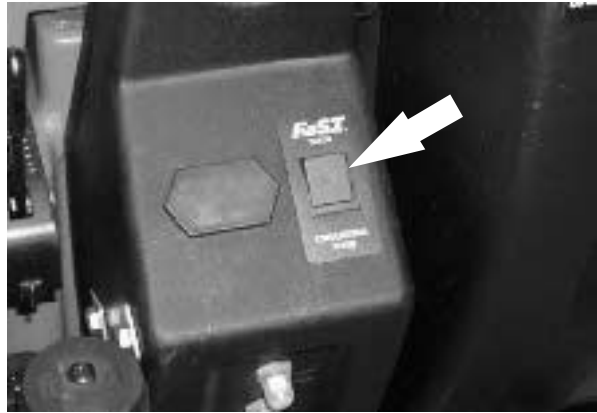

### RECOVERY TANK FULL LIGHT

The recovery tank full indicator comes on when the recovery tank is full. When the light comes on, the vacuum fan shuts off after a short delay.

On machines serial number 017946 and above, the light is located in the center of the console panel.



On machines below serial number 017946, the light is located in the upper left of the console panel.



## OPERATION

### ES SWITCH (OPTION)

The ES switch turns on and off the solution recycling system.

On: Press the top of the switch. The switch will light up.

Off: Press the bottom of the switch.



### BATTERY DISCHARGE INDICATOR

The battery discharge indicator shows the charge level of the batteries. The meter's needle should be at the top of the **green** zone when the batteries are fully charged. As the batteries discharge, the needle will move into the bottom **red** zone.

Recharge the batteries when the needle remains in the bottom **red** zone.

*NOTE: The reading on the battery discharge indicator is not accurate when the machine is first powered on. Operate the machine a few minutes before reading the charge level of the batteries.*



### BRUSH PRESSURE GAUGE

The brush pressure gauge shows how hard the scrub brush motors are working. The brush pressure should be operated in the **green** zone. Operating in the **red** zone indicates excessive brush pressure, and will cause the scrub brush circuit breakers to trip.

Adjust the brush pressure during scrubbing with the scrub brushes switch.



### SCRUB BRUSHES DOWN LIGHT

The scrub brushes down light comes on when the scrub brushes are lowered enough to touch the floor. The light goes off when the scrub brushes are raised off the floor.

On machines serial number 017946 and above, the light is located in the scrub brush switch.



On machines below serial number 017946, the light is located above the scrub brush switch.



### SCRUB BRUSHES SWITCH

The scrub brushes switch controls the scrub brushes position and down pressure.

Lower brushes: Press and hold the top of the switch until the scrub brush down light comes on.

Raise brushes: Press and hold the bottom of the switch until the scrub brush down light goes off.

Increase brush pressure: Press the top of the switch. Watch the brush pressure gauge.

Decrease brush pressure: Press the bottom of the switch. Watch the brush pressure gauge.

*NOTE: The scrub brushes do not start until the steering handles are rotated forward or backward.*

*NOTE: The scrub switch also controls the FaST system (option) when the FaST system is enabled with the FaST switch.*



## OPERATION

### HOURLMETER

The hourmeter records the number of hours the machine has been powered on. This information is useful when servicing the machine.

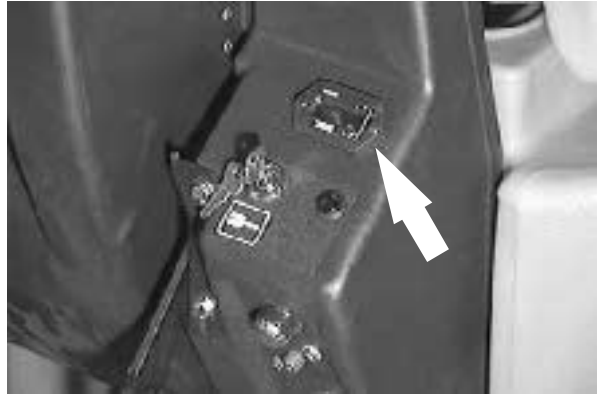

### MACHINE ON LIGHT

The machine on light comes on when the machine is powered on with the on-off key switch. The machine on light goes off when the machine is powered off.

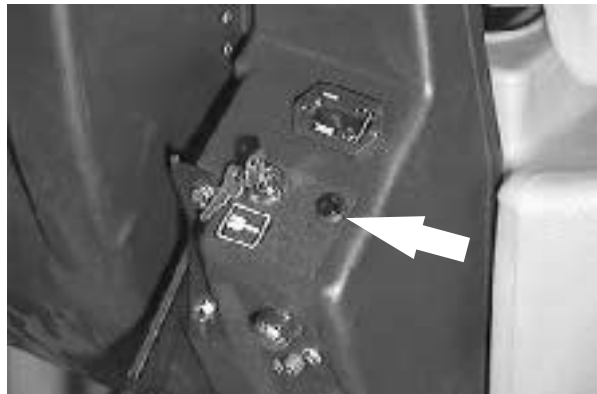

### ON-OFF KEY SWITCH

The on-off key switch controls machine power with a key.

On: Turn the key to the right.

Off: Turn the key to the left.





**SQUEEGEE LEVER**

The squeegee lever controls the squeegee and the vacuum system.

Lower squeegee and start vacuum: Move the squeegee lever up and to the left to unlock it, and then release the lever.

Raise squeegee and stop vacuum: Pull the lever up and move it to the right to lock the lever in the up position.

*NOTE: Raise the squeegee before reversing the machine.*

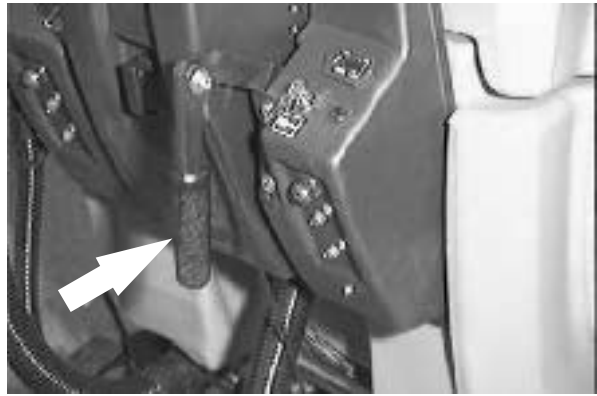
**SPEED REDUCTION KNOB (OPTION)**

The speed reduction knob adjusts the machine's maximum travel speed.

To reduce the maximum travel speed, turn the knob to the left.

To increase the maximum travel speed, turn the knob to the right.

**POWER KILL SWITCH (OPTION)**

The power kill switch halts all power to the machine.

Halt: Hit the power kill switch.

Restart: Turn the power kill switch to the right to release the switch. Turn off the machine power, then turn on the machine power.



## OPERATION

### CIRCUIT BREAKERS

The circuit breakers are resettable electrical circuit protection devices. They stop the flow of current in the event of a circuit overload. Once a circuit breaker is tripped, reset manually by pressing the reset button after the breaker has cooled down.

If the overload that caused the circuit breaker to trip is still there, the circuit breaker will continue to stop current flow until the problem is corrected.

The circuit breakers are located on each side of the operator console.

The chart shows the circuit breakers and the electrical components they protect.



<b>Circuit Breaker</b>	<b>Rating</b>	<b>Circuit Protected</b>
CB1	2.5 A	Machine power
CB2	25 A	Vacuum fan
CB2	40 A	Heavy duty vacuum fan
CB3	25 A	Machine propel
CB4	10 A	Machine controls
CB5	20 A	Scrub brush
CB5	35 A	Heavy duty disk scrub brush
CB6	20 A	Scrub brush
CB6	35 A	Heavy duty disk scrub brush

**FUSES (OPTION)**

The *fuse* is a one-time protection device designed to stop the flow of current in the event of a circuit overload.

*NOTE: Always replace the fuse with a fuse of the same amperage.*



The *fuse* is in-line and located near the air pump on the front of the recovery tank.

Fuse	Rating	Circuit Protected
FU-1	10 A	FaST (option)



**SOLUTION TANK HOSE**

The solution tank hose is used to drain the solution tank. The drain hose plug is removed by turning the plug latch to loosen the plug and pulling the plug out of the drain hose. The drain hose is plugged by placing the hose plug in the end of the hose and turning the plug latch to tighten the plug.

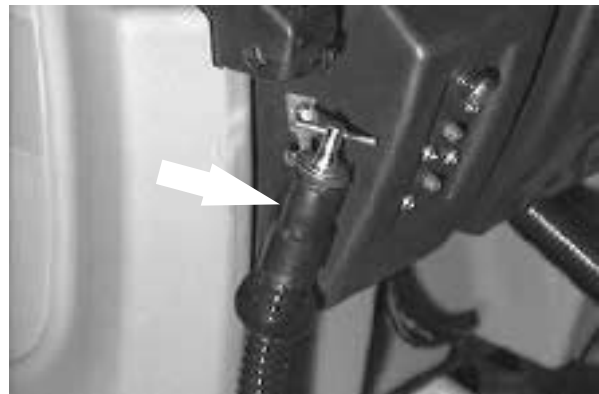

## OPERATION

### RECOVERY TANK DRAIN HOSE

The recovery tank drain hose is used to drain the recovery tank. The drain hose plug is removed by turning the plug latch to loosen the plug and pulling the plug out of the drain hose. The drain hose is plugged by placing the hose plug in the end of the hose and turning the plug latch to tighten the plug.



### SUPPORT ARM

The support arm holds up the solution tank when the tank is lifted. The support arm engages when the solution tank is lifted all the way open. The arm is released by pulling up on it.



### STOP ARM

The stop arm prevents the solution tank from fully closing when the tank is lowered. Push the arm in to lower the solution tank completely.

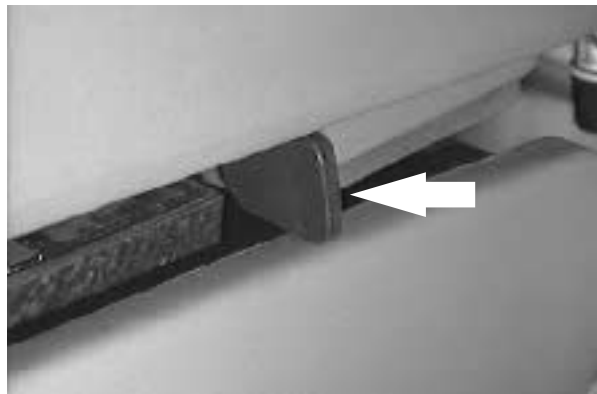

**SQUEEGEE DOWN PRESSURE CAMS**

The squeegee down pressure cams adjust the squeegee deflection along the entire length of the squeegee.

Increase: Turn the cams clockwise.

Decrease: Turn the cams counter-clockwise.

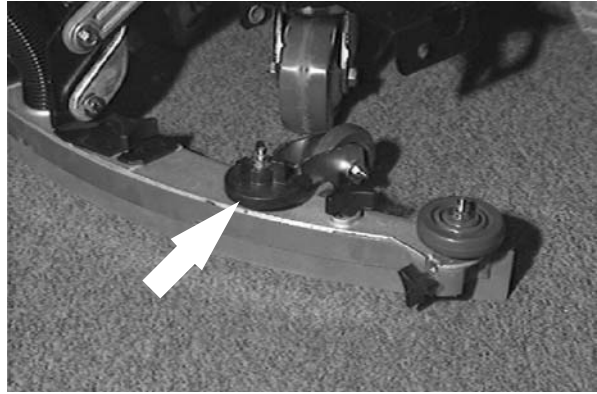
**SQUEEGEE LEVELING KNOB**

The squeegee leveling knob adjusts the deflection at the ends of the squeegee.

Increase: Turn the squeegee leveling knob counter-clockwise to increase the deflection at the end of the squeegees.

Decrease: Turn the squeegee leveling knob clockwise to decrease the deflection at the end of the squeegees.

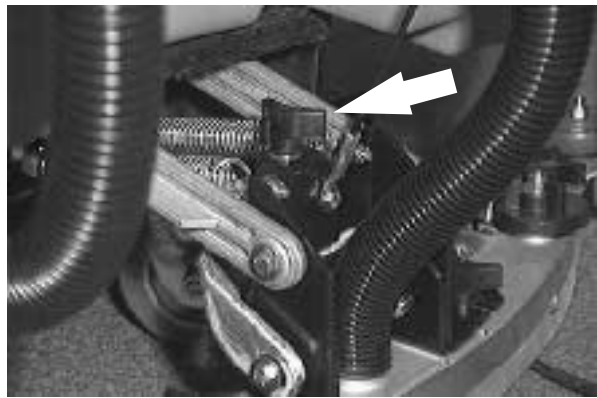
**PARKING BRAKE (OPTION)**

The parking brake is controlled with a foot pedal and a release lever located by the squeegee.

Set: Push down on the foot pedal.

Release: Pull up on the release lever.



## HOW THE MACHINE WORKS

---

The scrub components of the machine are a solution tank, scrub brushes, a squeegee, a vacuum fan, and a recovery tank.

Water and detergent, from the solution tank, flow to the floor through a solution valve to the scrub brushes. The brushes scrub the floor. As the machine is moved forward the squeegee wipes the dirty solution off the floor, which is then picked up and drawn into the recovery tank.

The steering handles control the direction and speed of the machine in forward or reverse. By rotating the steering handles forward, the machine propels forward. By rotating the handles towards you the machine propels backward.

When using the ES mode, the dirty solution in the recovery tank is filtered and returned to the solution tank to be reused.

Three different widths of scrub heads and squeegees are available for the machine, along with two different brush types.

The scrub head widths are as follows; the model 700 (700 mm (28 in)), the model 800 (800 mm (32 in)), and the model 900 (900 mm (36 in)). The 700 mm (28 in) squeegee is used with the 700 model scrub head, as well as the 800 mm (32 in) with the model 800, and the 900 mm (36 in) with the model 900. The two available brush types are disk and cylindrical.



### FaST SCRUBBING SYSTEM (OPTION)

The FaST (Foam Scrubbing Technology) system operates by injecting the FaST PAK concentrate agent (A) into the system with a small amount of water and compressed air. This mixture creates a large volume of expanded wet foam.

The expanded foam mixture is then dispersed onto the floor (B) while the machine is scrubbing. When the squeegee picks up the mixture, the patented foaming agent has collapsed and is recovered into the recovery tank.

The FaST system can be used with all double scrubbing and heavy duty scrubbing applications.

Using the FaST system can increase productivity by 30% by reducing your dump/fill cycle. It will also reduce chemical usage and storage space. One FaST PAK of concentrated agent can scrub up to 1 million sq. ft.

*NOTE: Do not enable the FaST system with conventional cleaning detergents in the solution tank. Drain, raise and refill the solution tank with clear cool water only before operating the FaST system. Conventional cleaning detergents/restorers may cause failure to the FaST solution system.*

*NOTE: Storage or transporting machines equipped with FaST in freezing temperatures requires special procedures. Check with a TENNANT representative for advice.*

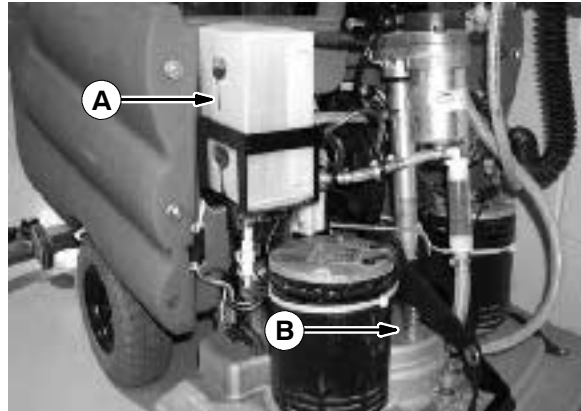

**FaST**  
Foam Scrubbing Technology

**The safe scrubbing alternative™**

## PRE-OPERATION CHECKLIST

---

Check over this list of items before operating the machine:

- Check the battery fluid and charge level.
- Check the tank cover seals for damage and wear.
- Clean the vacuum fan inlet filter.
- Check the condition of the scrubbing brushes. Remove any string, banding, plastic wrap, or other debris wrapped around them.
- Check the squeegees for damage, wear and for deflection adjustment.
- Check the vacuum hose for debris or blockage.
- ES machines; check the detergent tank level.
- Drain and clean the recovery tank.
- ES machines; drain and clean the solution tank and ES filter. Rinse level sensors.
- Empty and clean the debris tray. (if applicable).
- Check the service records to determine maintenance requirements.
- FaST SCRUBBING: Check the FaST PAK (option) concentrate agent level, replace carton as needed. See the INSTALLING THE FaST PAK AGENT section of the manual.
- FaST SCRUBBING: Check that all conventional cleaning agents/restorers are drained and rinsed from the solution tank.
- FaST SCRUBBING: Check that the solution tank is filled with **clear cool water only**.



## INSTALLING FaST PAK AGENT (OPTION)

*NOTE: Machine must be equipped with the FaST option before the FaST PAK agent can be installed.*

1. Remove the perforated knock-outs from the FaST PAK Floor Cleaning Concentrate carton. Do not remove the bag from the carton. Pull out the bag's hose connector on the bottom of the bag and remove the hose cap from the connector.

***NOTE: The FaST PAK Floor Cleaning Concentrate is specifically designed for use with the FaST system scrubbing application. NEVER use a substitute, machine damage will result.***

**FOR SAFETY: When using machine, always follow the handling instructions on chemical container.**

2. Empty the solution tank. See the DRAINING AND CLEANING THE TANKS section of the manual.

*NOTE: When scrubbing with the FaST system option, use clean water only. Do not add cleaning agents/restorers in the solution tank. Conventional cleaning agents/restorers may cause failure to the FaST solution system..*

3. Raise the solution tank and remove the front cover to access the FaST PAK carton.



## OPERATION

4. Place the FaST PAK carton in the carton holder under the front cover of the machine. Connect the supply hose to the FaST PAK bag.

*NOTE: If any dried concentrate is visible on the supply hose connector or the on the FaST PAK connector, soak and clean with warm water.*

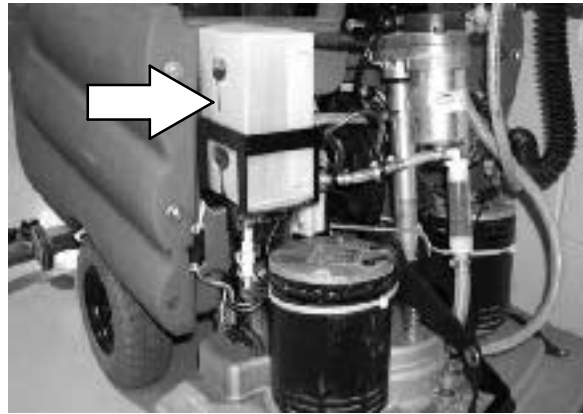

5. Make sure to connect the supply hose onto the hose storing plug when the supply hose is not connected to the FaST PAK. This will prevent the FaST solution system from drying out and clogging up the hose.

6. When replacing an empty FaST PAK carton, allow the new FaST PAK detergent to gravity feed into the system for several minutes prior to operating the FaST system. If the detergent does not flow out of the FaST PAK, simply squeeze and release the hose several times. If the previous FaST PAK was run dry, it may take up to 3 minutes of operation to remove any air pockets in the system before you achieve maximum foaming.



---

**STARTING THE MACHINE**

---

6. Turn the machine power on.



7. Release the machine parking brake, if your machine has this option.



---

**FILLING THE TANKS**

---

1. Start the machine.
2. Drive the machine to the filling site.



## OPERATION

3. Turn the machine power off.

**FOR SAFETY:** Before leaving or servicing machine, stop on level surface, set parking brake (if so equipped), turn off machine, and remove key.



4. Set the parking brake, if your machine has this option.

*NOTE: If you are going to scrub in the ES mode, the recovery tank can be partially filled to extend scrub time. Make sure the ES system is on.*

*If you **do not** want to use the ES system, make sure the ES system is off. DO NOT fill the recovery tank.*



5. ES mode: Lift up the solution tank. Fill the recovery tank with water 50 mm (2 in) below the top of the ES filter located on the bottom of the tank, approximately 87 L (23 gal) of water.



6. ES mode: Lower the solution tank.



7. CONVENTIONAL SCRUBBING: Open the solution tank cover and partially fill the solution tank with water. Pour the required amount of detergent into the solution tank fill opening. Continue filling the solution tank with water 25 mm (1 in) below the bottom of the solution fill opening channel.

**FOR SAFETY: Follow mixing and handling instructions on chemical containers.**

8. FaST SCRUBBING: Open the solution tank cover and fill the solution tank with clear cool water only.



**NOTE: When cleaning using FaST option, USE CLEAR COOL WATER ONLY. DO NOT add cleaning agents in solution tank. Conventional cleaning agents/restorers may cause failure to the FaST solution system.**

*NOTE: Floor conditions, water condition, amount of soilage, types of soilage, and brush action all play an important role in determining the type and concentration of detergent used. For specific recommendations, contact your Tennant representative.*



**WARNING: Flammable materials can cause an explosion or fire. Do not use flammable materials in tank(s).**

## NORMAL SCRUBBING

- Pick up oversized debris before scrubbing. Pick up pieces of wire, string, twine, etc., which could become wrapped around the scrub brush.
- Plan the scrubbing in advance. Try to arrange long runs with minimum stopping and starting. Do an entire floor or section at one time.
- Try to scrub as straight a path as possible. Avoid bumping into posts or scraping the sides of the machine. When scrubbing dead end aisles, start at the closed end of the aisle and scrub your way out. Overlap the scrub paths by a few centimeters (inches).
- If you see poor scrubbing performance, stop scrubbing and refer to *MACHINE TROUBLESHOOTING*.

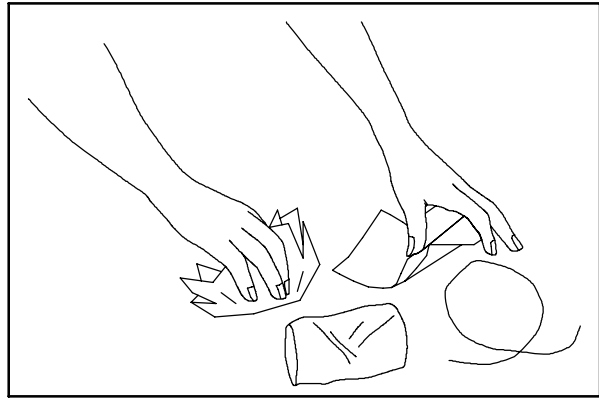

07218

**Non-scuff polypropylene scrub brush** - This brush uses a softer, general purpose polypropylene bristle to lift lightly compacted soilage without scuffing high-gloss coated floors.

**Nylon scrub brush** - Recommended for scrubbing coated floors. Cleans without scuffing.

**Super abrasive bristle scrub brush** - Nylon fiber impregnated with abrasive grit to remove stains and soilage. Strong action on any surface, performing well on buildup, grease, or tire marks.

**Heavy duty stripping pad** - This black pad is for stripping floors. Cuts through old heavy finishes easier, to prepare the floor for re-coating.

**Stripping pad** - This brown pad is for stripping floors. Quickly and easily cuts through old finish to prepare the floor for re-coating.

**Scrubbing pad** - This blue pad is for scrubbing floors. Removes dirt, spills and scuffs, leaving a clean surface ready for re-coating.

**Buffing pad** - This red pad is for buffing floors. Quickly cleans and removes scuff marks while polishing the floor to a high gloss.

**Polishing pad** - This white pad is for polishing floors. Maintains a high gloss. Use for buffing very soft finishes and lower traffic areas, or use for polishing soft waxes on wood floors.

**Cylindrical polypropylene scrub brush** – This cylindrical brush uses a softer, general purpose polypropylene bristle to lift lightly compacted soilage without scuffing high-gloss coated floors.

**Cylindrical nylon scrub brush** – This cylindrical brush is recommended for scrubbing coated floors. Cleans without scuffing.

**Cylindrical super abrasive bristle scrub brush** – Nylon fiber impregnated with abrasive grit to remove stains and soilage. Strong action on any surface, performing well on buildup, grease, or tire marks.

*NOTE: Cylindrical scrub brushes must be installed with the herringbone patterns on the brushes pointing towards each other for best debris pick up.*

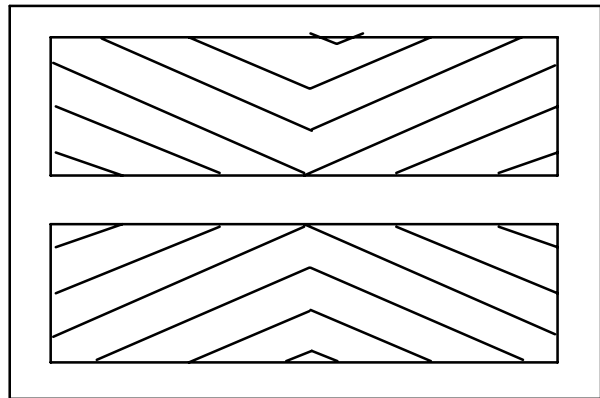

1. Start the machine.
2. Drive the machine to the area to be scrubbed.



3. Lower the squeegee to the floor with the squeegee lever.

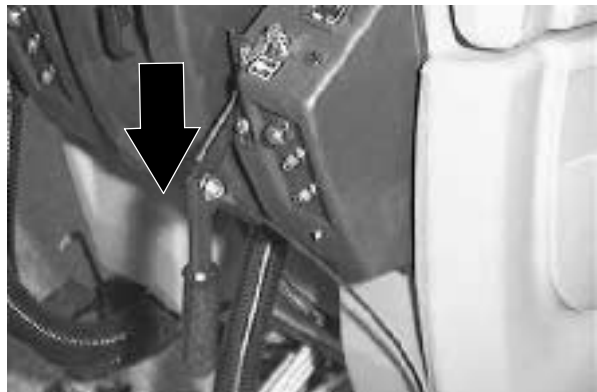

## OPERATION

4. FaST SCRUBBING: Press the top of the FaST switch to start the FaST system.

*NOTE: When using the FaST system (option), the solution flow lever is nonfunctional. The FaST system flow rate is pre-set.*

*NOTE: Leave the FaST switch in the CONVENTIONAL SCRUBBING position if not using the FaST system.*

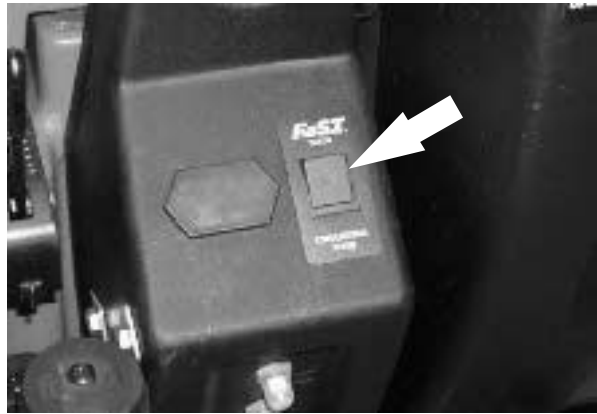

5. Press the top of the scrub brushes switch until the scrub brush down light comes on.



6. CONVENTIONAL SCRUBBING: Adjust the solution flow to the floor as needed.

*NOTE: When using the FaST system (option), the solution flow lever is nonfunctional. The FaST system flow rate is pre-set.*

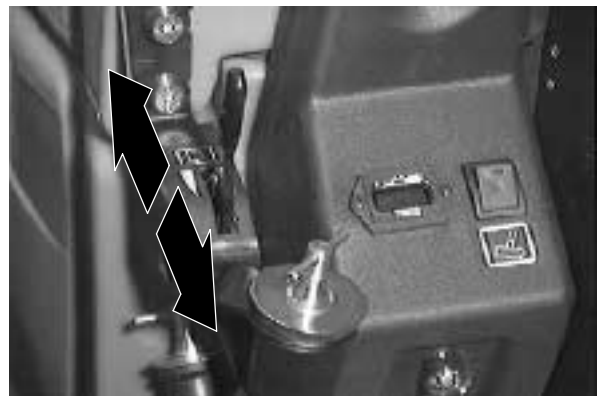



7. Drive the machine forward and scrub as required.

**⚠ WARNING: Flammable materials or reactive metals can cause an explosion or fire. Do not pickup.**



8. Adjust brush pressure for cleaning application with the scrub brushes switch, while watching the brush pressure gauge.

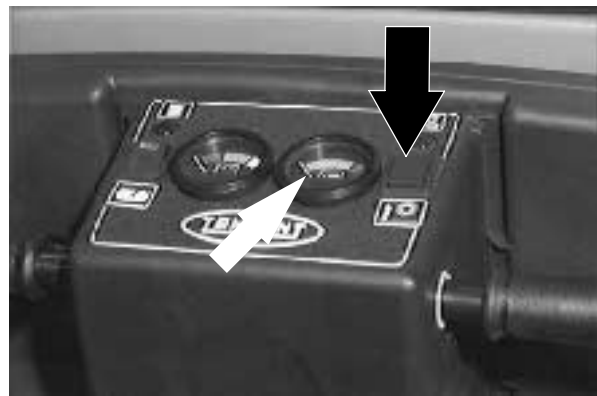

---

**DOUBLE SCRUBBING**

---

Double scrubbing is a method for removing heavy floor accumulations. This is done by making two passes over the area to be cleaned with the machine.

Double scrubbing can be performed using the FaST SCRUBBING SYSTEM (option) or CONVENTIONAL SCRUBBING methods.

First, make a pass over the area scrubbing with the squeegee up. This dispenses solution over the area allowing the solution to soak on the floor. Let the solution remain on the floor for 15 to 20 minutes. Then make a second pass scrubbing with the squeegee down.

*NOTE: When using the FaST system (option), the solution flow lever is nonfunctional. The FaST system flow rate is pre-set.*

**FOR SAFETY: When using machine, go slow on inclines and slippery surfaces.**

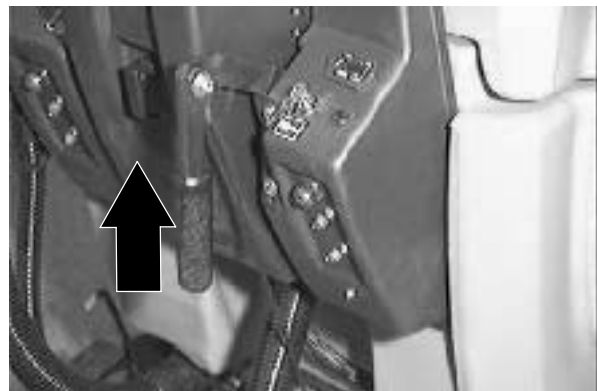

## STOP SCRUBBING

1. Release the steering handles.



2. Raise the scrub brushes with the scrub brushes switch until the scrub brushes down light goes off.



3. Raise the squeegee with the squeegee lever.

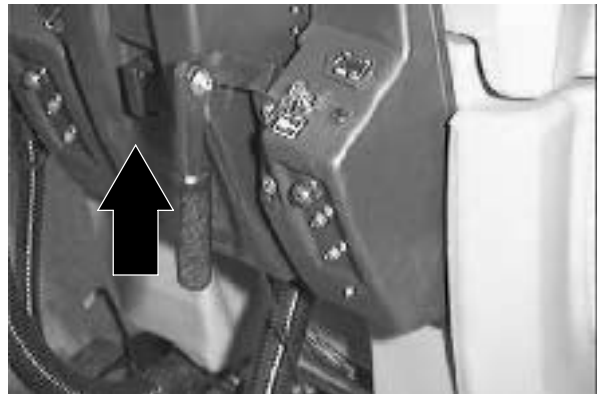

---

**DRAINING AND CLEANING THE TANKS**

---

When you are finished scrubbing, or when the recovery tank full light comes on, the recovery tank should be drained and cleaned. The solution tank then can be filled again for additional scrubbing.

If you used the machine in ES mode, the solution tank should also be drained and cleaned when you are finished scrubbing.

1. Stop scrubbing.
2. Drive the machine next to a floor drain or sink.



3. Turn the machine power off.

**FOR SAFETY: Before leaving or servicing machine, stop on level surface, and turn off machine.**



4. Set the parking brake, if your machine has this option.



## OPERATION

5. ES mode: Remove the solution tank drain hose from the mounting clip.



6. ES mode: Remove the drain hose plug while holding the hose up, then slowly lower the drain hose to the floor drain.



7. ES mode: Lift the solution tank cover and flush out the solution tank with clean water through the fill opening and the top access hole. Rinse the filter(s) at the bottom of the solution tank.

**NOTE:** *Do not* use steam to clean the tank.

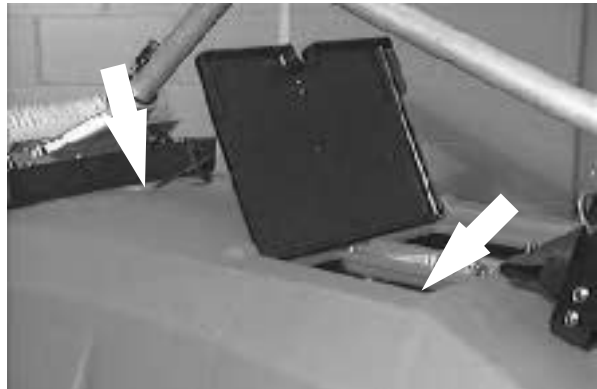

8. ES mode: When the solution tank has completely drained, replace the drain hose plug in the solution tank drain hose and place the solution tank drain hose back onto the mounting clip on the machine.

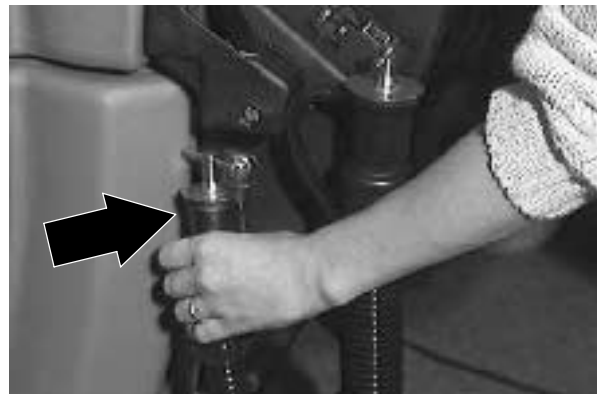

9. Remove the recovery tank drain hose from the mounting clip.



10. Remove the drain hose plug while holding the hose up, then slowly lower the drain hose to the floor drain or sink.



11. Lift the solution tank to reach the recovery tank.



12. Flush out the inside of the recovery tank with clean water.

**NOTE:** *Do not* use steam to clean the tank.



## OPERATION

13. ES mode: Rinse the ES filter.

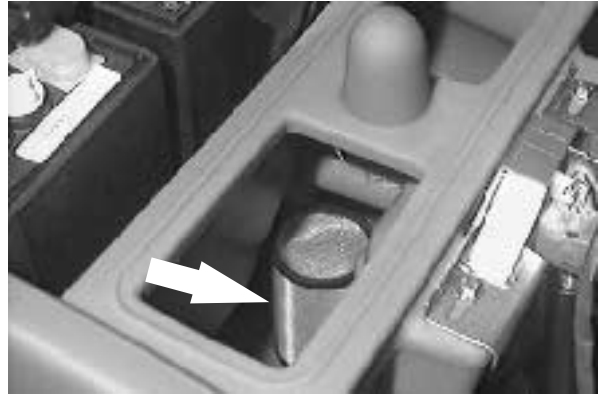

14. Rinse and wipe off the level sensor(s) on the side of the recovery tank.



15. For machines below serial number 006956, remove and clean the vacuum fan screen located in the solution tank. Insert the screen back in to vacuum inlet when finished.



For machines serial number 006956 and above, remove and clean the vacuum fan filter located in the recovery tank. Clean by shaking dust or rinsing pleats with low pressure water. Insert the filter back in to the recovery tank when finished.



*NOTE: Be sure the vacuum filter is dry before reinstalling it in the machine.*

16. When the tank has completely drained, replace the drain hose plug in the recovery tank drain hose. Place the recovery tank drain hose back onto the mounting clip on the machine.



17. Pull up on the support arm and lower the solution tank. Push the stop arm in to completely lower the solution tank.



18. Cylindrical scrub head: Remove and clean the debris trough. Place the trough back in the scrub head.

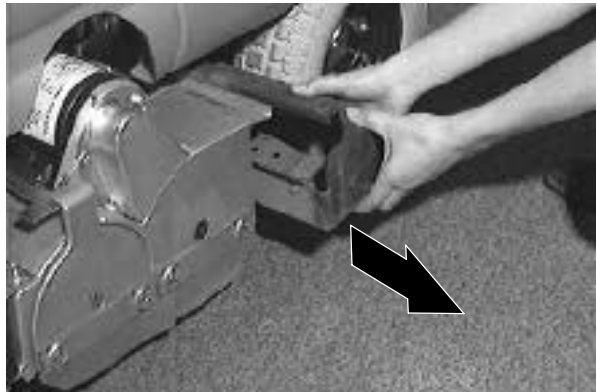

## OPERATION

---

### STOP THE MACHINE

---

1. Stop scrubbing.
2. Turn the machine power off.



3. Set the parking brake, if your machine has that option.

**FOR SAFETY: Before leaving or servicing machine, stop on level surface, set parking brake (if so equipped), turn off machine, and remove key.**



---

### OPERATION ON INCLINES

---

Drive the machine slowly on inclines.

**FOR SAFETY: When using machine, go slow on inclines and slippery surfaces.**

The maximum rated climb and descent incline with empty tanks is 8°, with full tanks is 6°.



---

**POST-OPERATION CHECKLIST**

---

Check over this list of items after you have finished scrubbing with the machine powered on:

- Check the battery fluid and charge level.

*NOTE: The reading on the battery discharge indicator is not accurate when the machine is first powered on. Operate the machine a few minutes before reading the charge level of the batteries.*

Check over this list of items with the machine powered off:

- Check the tank cover seals for damage and wear.
- Clean the vacuum fan inlet filter.
- Check the condition of the scrubbing brushes. Remove any string, banding, plastic wrap, or other debris wrapped around them.
- Check the squeegees for damage, wear and for deflection adjustment.
- Check the vacuum hose for debris or blockage.
- ES machines; check the detergent tank level.
- Drain and clean the recovery tank.
- ES machines; drain and clean the solution tank and ES filter. Rinse level sensors.
- Empty and clean the debris tray. (if applicable).
- Check the service records to determine maintenance requirements.
- FaST scrubbing: If FaST PAK is empty after scrubbing, install a new FaST PAK or connect supply hose to the storage plug.

# OPERATION

## MACHINE TROUBLESHOOTING

Problem	Cause	Remedy	
Trailing water - poor or no water pickup	Worn squeegee blades	Rotate or replace squeegee blades	
	Squeegee out of adjustment	Adjust squeegee	
	Vacuum hose clogged	Flush vacuum hoses	
	Vacuum fan screen dirty	Clean inlet screen	
	Debris caught on squeegee	Remove debris	
	Vacuum hose to squeegee or recovery tank disconnected or damaged	Reconnect or replace vacuum hose	
	Solution tank not completely closed	Check for obstructions	
		Heavy duty batteries posts too tall, file down posts	
Machine front cover mounted too high, mount cover lower			
Torn seals on solution tank	Replace seals		
Vacuum fan will not turn on	Recovery tank full	Drain recovery tank	
	Foam filling recovery tank	Empty recovery tank	
		Use less or change detergent	
		Use a defoamer	
Vacuum fan circuit breaker tripped	Reset circuit breaker		
Vacuum fan will not turn on, optical sensor(s)	Recovery tank full sensor(s) dirty	Clean sensor(s) and reset key switch	
	Oily/ink film buildup on recovery tank sensor(s)	Use correct detergent	
		Change to magnetic sensor(s)	
Operating in bright sunlight	Install sensor sun shield(s)		
Little or no solution flow to the floor	Solution tank empty	Fill solution tank	
	Solution control cable broken or out of adjustment	Replace and/or adjust cable	
	Solution flow turned off	Turn solution flow on	
	Solution supply lines plugged	Flush solution supply lines	
	Solution supply line filter dirty	Clean filter	
	Solution solenoid clogged or stuck	Clean or replace	
	ES mode: ES switch off	Turn ES switch on	
	Poor scrubbing performance	Debris caught on scrub brushes	Remove debris
Improper detergent, brush, or pad used		Check with TENNANT representative for advice	
Worn scrub brush(es) or pad(s)		Replace scrub brush(es) or pad(s)	
Scrub brush motor circuit breaker(s) tripped		Reset circuit breaker(s)	
		Reduce scrub brush down pressure	
		Uneven brush pressure, level scrub head	
		Broken brush drive belts on cylindrical scrub head, replace belt	
		Check with TENNANT representative for advice	
Low battery charge		Charge batteries until the charger automatically turns off	
Tire pressure low		Increase tire pressure	

Problem	Cause	Remedy
Poor propelling traction	Brush pressure set too high	Decrease brush pressure
	Tires slip on oily or waxed floors	Check with TENNANT representative for advice
	Uneven brush down pressure	Level scrub head
Broken brush drive belts on cylindrical scrub head, replace belt		
FaST System (option) does not operate	FaST switch is set for Conventional scrubbing	Set the FaST switch for FaST system scrubbing
	FaST fuse blown	Determine cause and replace the 10A fuse
	Clogged FaST PAK supply hose and/or connectors	Soak connector and hose in warm water and clean
	FaST PAK carton is empty or not connected	Replace FaST PAK carton and/or connect supply hose
	Clogged flow control orifice and/or screen	Remove and clean orifice and/or screen
	Faulty pump or air compressor	Contact TENNANT representative
	Clogged filter screen	Drain solution tank, remove and clean filter screen
	FaST system is not primed	To prime, operate the FaST solution system for 3 minutes.

## OPTIONS

---

### VACUUM WAND

The vacuum wand uses the machine's vacuum system. The vacuum hose allows pick-up of spills that are out of reach of the machine.

 **WARNING: Flammable materials or reactive metals can cause an explosion or fire. Do not pickup.**

1. Turn the machine power off.

**FOR SAFETY: Before leaving or servicing machine, stop on level surface, and turn off machine.**

2. Set the parking brake, if your machine has this option.



3. Remove the squeegee suction hose from the top of the squeegee.

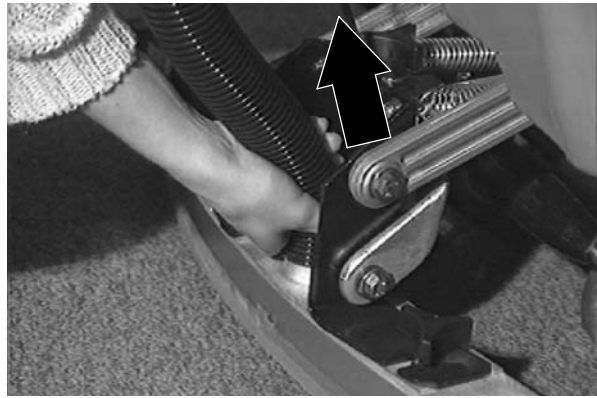

4. Put together the wand and the wand hose.

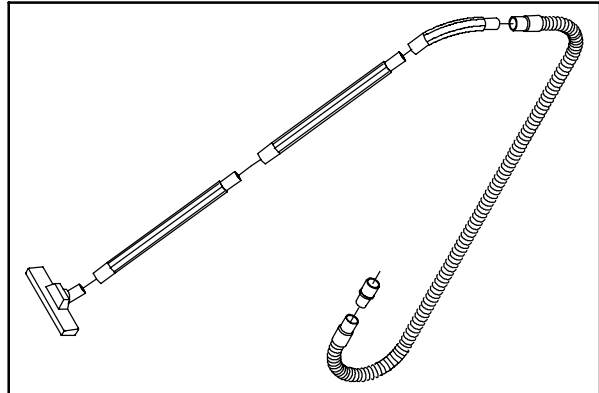

10080

5. Connect the vacuum wand hose and the squeegee suction hose with the adapter.



6. Turn the machine power on.



## OPERATION

7. Lower the squeegee with the squeegee lever to turn the vacuum system on.

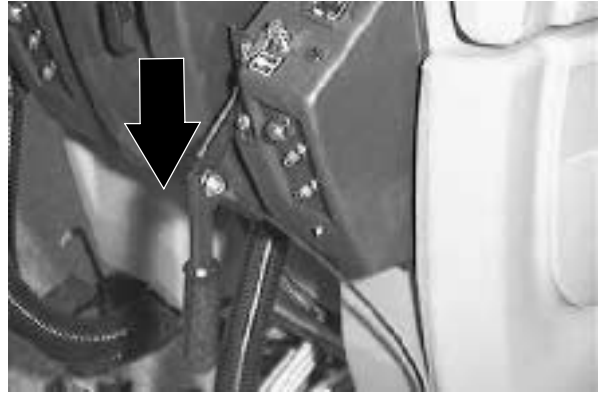

8. Vacuum the floor.

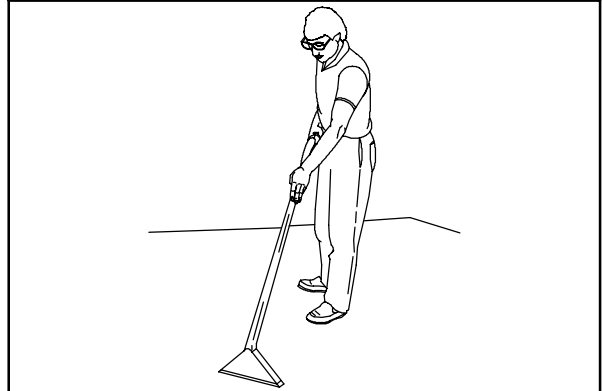

06599

9. When finished, raise the squeegee to shut off the vacuum.

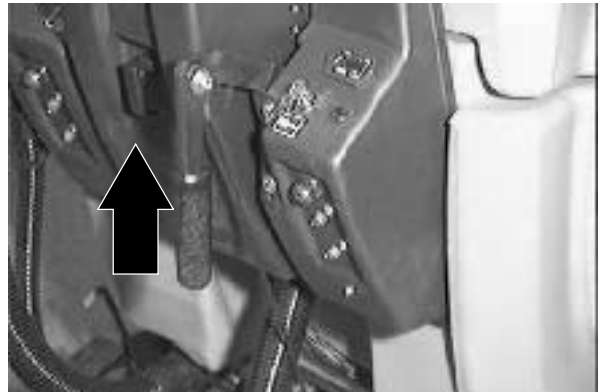

10. Turn the machine power off.



11. Remove the vacuum hose from the squeegee suction hose.



12. Reconnect the squeegee suction hose to the top of the squeegee.

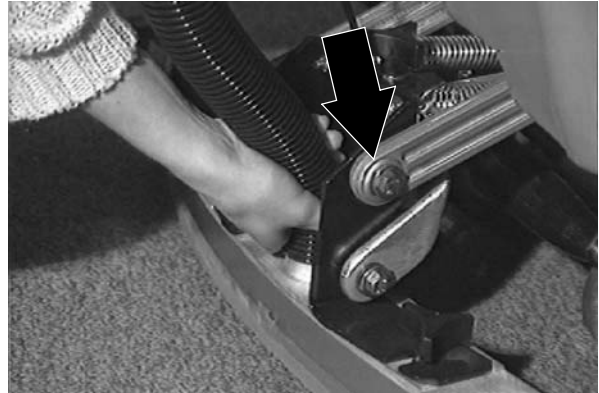

## OPERATION

### POWER WAND

The power wand uses the machine's vacuum and solution systems. The power wand allows scrubbing of floors that are out of reach of the machine.

 **WARNING: Flammable materials or reactive metals can cause an explosion or fire. Do not pickup.**

1. Turn the machine power off.

**FOR SAFETY: Before leaving or servicing machine, stop on level surface, and turn off machine.**

2. Set the parking brake, if your machine has this option.

3. Remove the squeegee suction hose from the top of the squeegee.

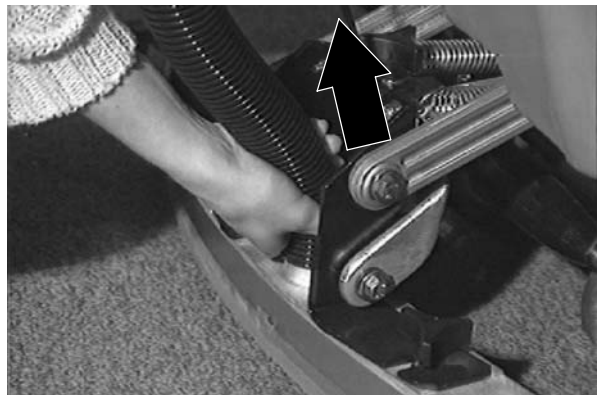
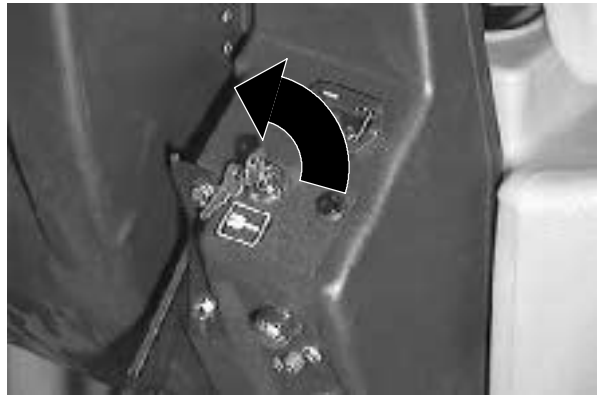



4. Connect the vacuum wand hose and the squeegee suction hose with the adapter.



5. Open the solution tank cover. Attach the end of solution hose to the quick-disconnect. Push the connector in until it stops. Pull on the hose to make sure it is connected.



6. Attach the other ends of the solution and vacuum hoses to the power wand.

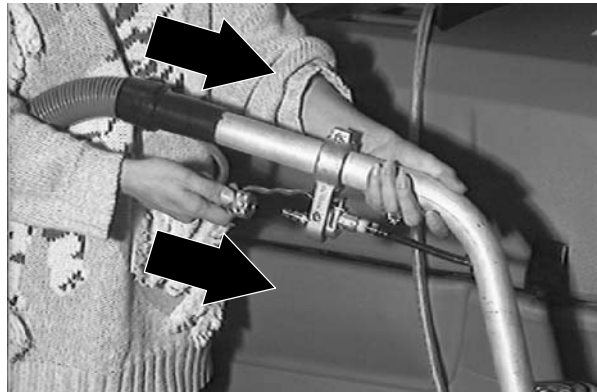

7. Turn the machine power on.



## OPERATION

- Lower the squeegee with the squeegee lever to turn the vacuum system on.

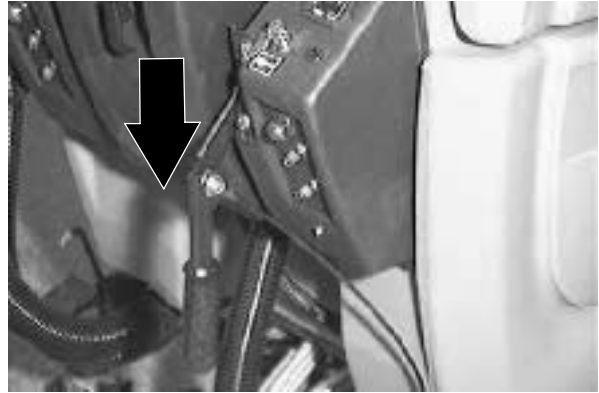

- Switch the power wand on.



- Squeeze the solution lever on the power wand to spray solution on the floor. Scrub the floor with the brush side of the cleaning tool.



- Vacuum up the solution by turning over the cleaning tool so the squeegee side is down.

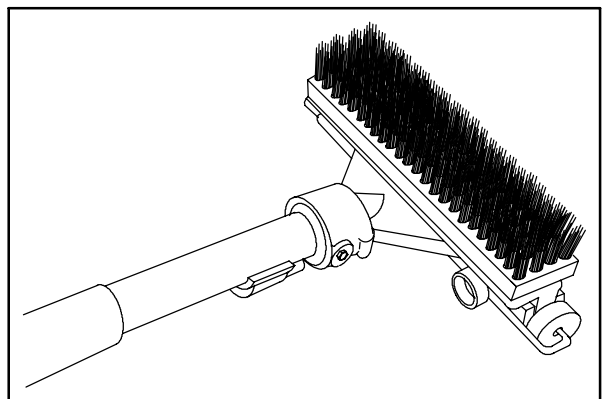

06202

If the cleaning tool is hard to push or is not picking up the solution very well, adjust the roller wheels on the tool by turning the black adjustment knob.

*NOTE: The wheels are properly adjusted when the squeegee blades deflect slightly while the tool is pushed back and forth.*

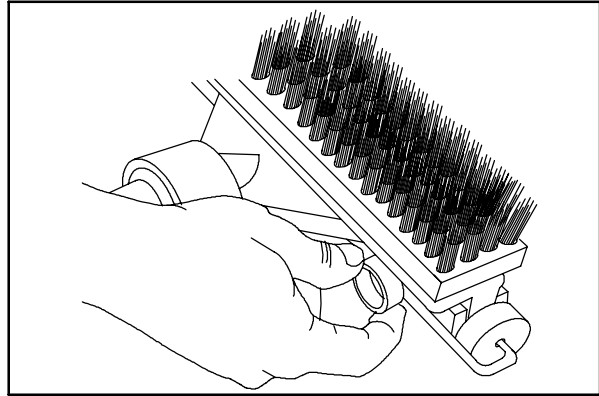

06604

12. When finished, switch the power wand off.



13. When finished, raise the squeegee to shut off the vacuum.

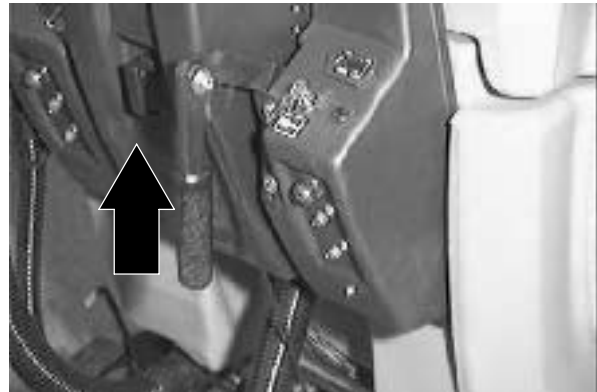

14. Disconnect the solution hose from the machine.

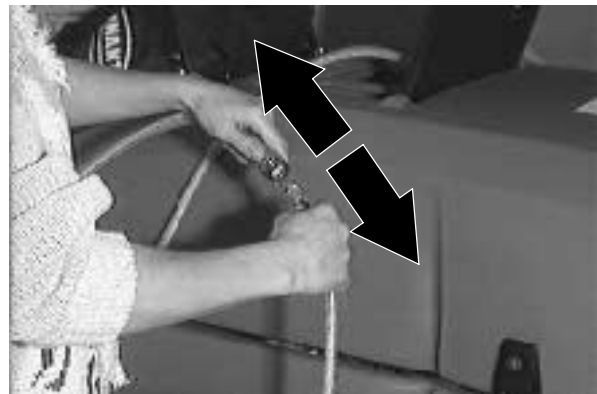

## OPERATION

15. Remove the vacuum hose from the squeegee suction hose.



16. Disconnect the other ends of the solution and vacuum hoses from the power wand.

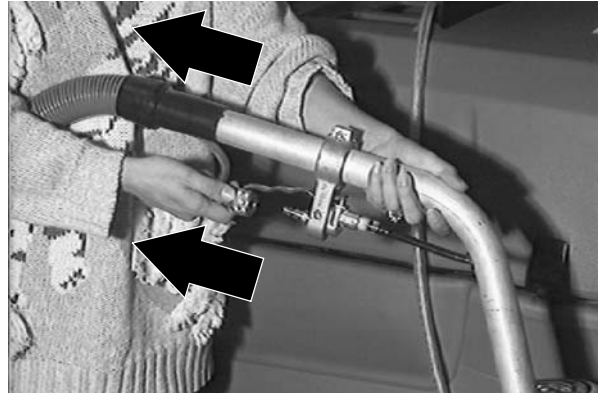

17. Turn the machine power off.

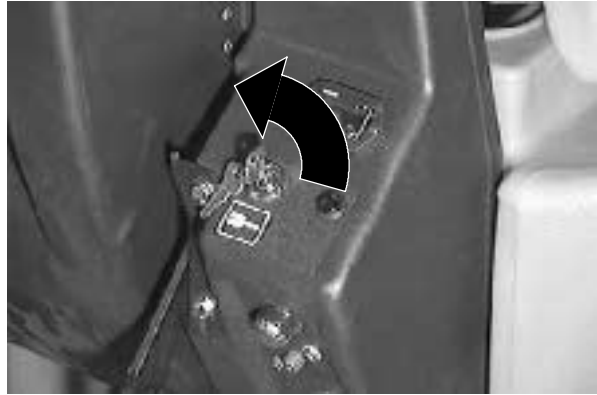

18. Reconnect the squeegee suction hose to the squeegee.

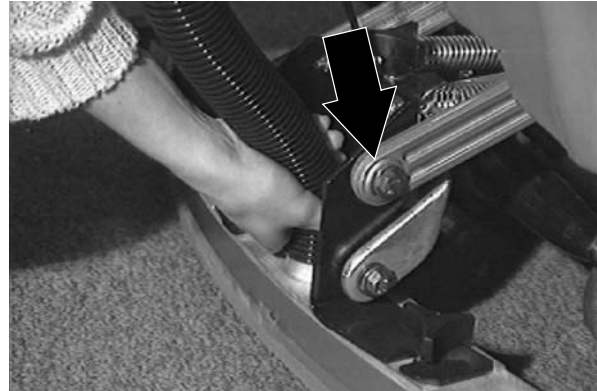

**MAINTENANCE**

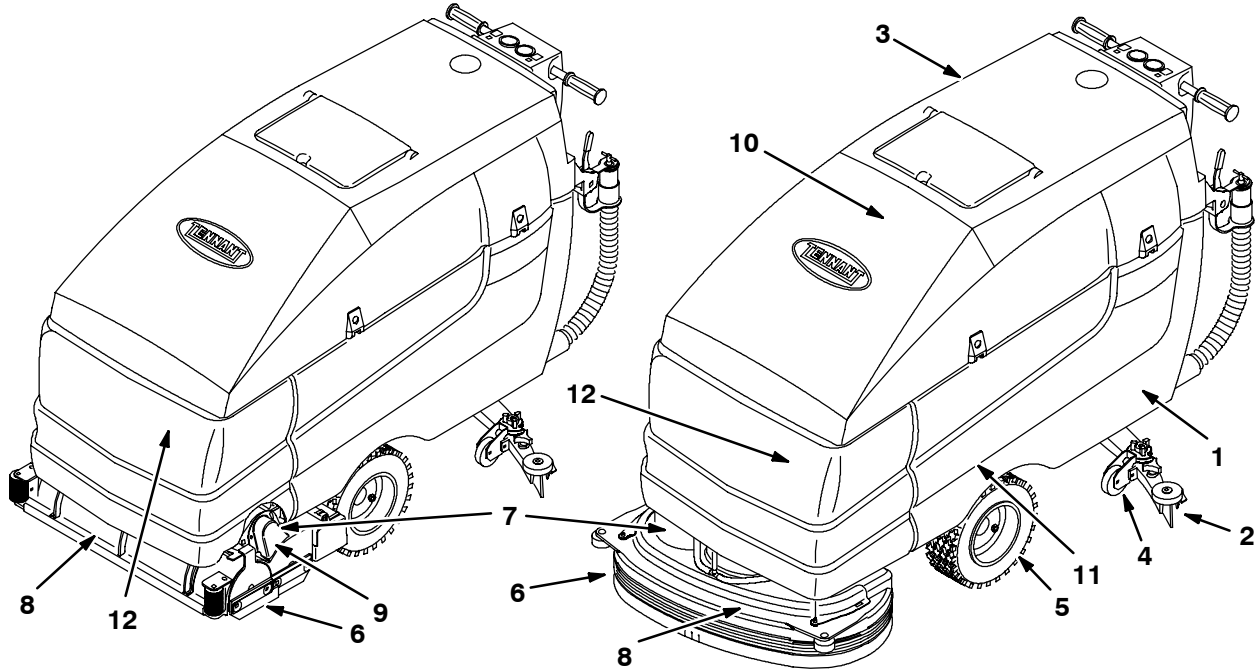

10066, 10190

**MAINTENANCE CHART**

Interval	Key	Description	Procedure	Lubricant/ Fluid	No. of Service Points
Daily	2	Squeegee	Check for damage and wear	-	1
			Check deflection and leveling	-	1
	8	Scrub brushes or pads	Check for damage and wear	-	2
	1	Recovery tank	Clean tank	-	1
			Clean level sensor	-	1(2)
	1	Recovery tank, ES mode	Clean ES filter	-	1
	3	Solution tank, ES mode	Clean	-	1
	3	Vacuum fan filter	Clean	-	1
		Machine	Check for leaks	-	1
	6	Disk scrub head skirt	Check adjustment	-	1
			Check for damage and wear	-	1
	6	Cylindrical scrub head skirts	Check adjustment	-	4
Check for damage and wear			-	4	
12	FaST PAK supply hose and connector (option)	Clean and connect hose to storing plug when not in use	-	1	
50 Hours	5	Front tires	Check air pressure	-	2
	8	Cylindrical brushes	Check taper and rotate front to rear	-	2
	12	FaST Filter screen (option)	Clean	-	1

<b>Interval</b>	<b>Key</b>	<b>Description</b>	<b>Procedure</b>	<b>Lubricant/ Fluid</b>	<b>No. of Service Points</b>
100 Hours	4	Rear casters	Lubricate	SPL	2
	9	Cylindrical scrub brush drive belts	Check tension	-	2
200 Hours	12	FaST Air filter (option)	Clean	-	1
500 Hours	10	Vacuum fan motor	Check motor brushes	-	1
1000 Hours	7	Scrub brush motors	Check motor brushes	-	2
	11	Propelling motor	Check motor brushes	-	1
	11	Transaxle	Check lubricant level	GL	1

SPL - Special lubricant, Lubriplate EMB grease (TENNANT part no. 01433-1)

GL - SAE 90 weight gear lubricant

## LUBRICATION

---

### REAR CASTERS

The rear casters each have one grease fitting on the caster swivel. Lubricate the caster with a grease gun containing Lubriplate EMB grease (TENNANT part no. 01433-1) every 100 hours of machine operation.

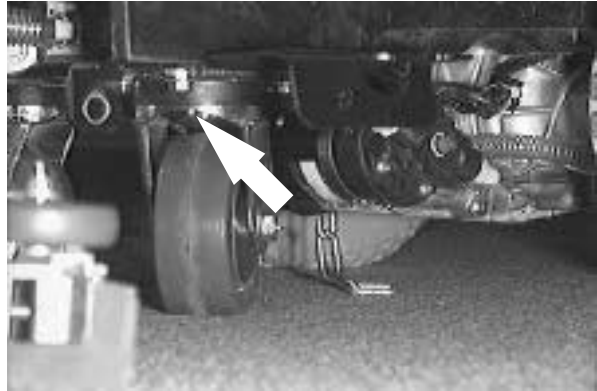

### TRANSAXLE

Check the transaxle lubricant level every 1000 hours of operation by removing one of the orange filler plugs. If needed, add SAE 90 weight gear lubricant.

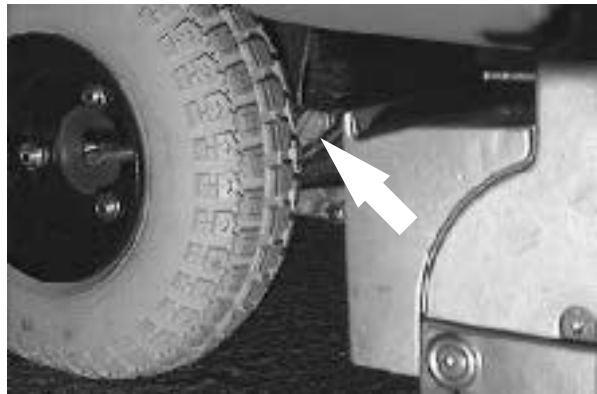

---

## BATTERIES

---

The batteries are unique in that they hold their power for long periods of time. The lifetime of the batteries is limited by the number of charges the batteries receive. To get the most life from the batteries, charge them when the battery discharge indicator's needle remains in the **red** zone of the indicator.

Periodically clean the top surface of the batteries and the terminals, and check for loose connections. Use a strong solution of baking soda and water. Brush the solution sparingly over the battery tops, terminals, and cable clamps. Do not allow any baking soda solution to enter the batteries. Use a wire brush to clean the terminal posts and the cable connectors. After cleaning, apply a coating of clear battery post protectant to the terminals and the cable connectors. Keep the tops of the batteries clean and dry.



Keep all metallic objects off the top of the batteries, which may cause a short circuit. Replace any worn or damaged wires.

Check the electrolyte level in each battery cell before and after charging, and after every 50 hours of operation. Do not charge the batteries unless the fluid is slightly above the battery plates. If needed, add just enough distilled water to cover the plates. Never add acid to the batteries. Do not overfill. Always keep the battery caps on, except when adding water or taking hydrometer readings.

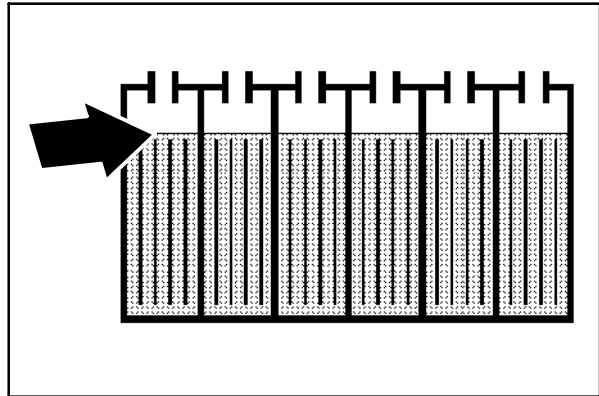

Measuring the specific gravity, using a hydrometer, is a way to determine the charge level and condition of the batteries. If one or more of the battery cells test lower than the other battery cells (0.050 or more), the cell is damaged, shorted, or is about to fail.

*NOTE: Do not take readings immediately after adding distilled water. If the water and acid are not thoroughly mixed, the readings may not be accurate. Check the hydrometer readings against the following chart to determine the remaining battery charge level:*

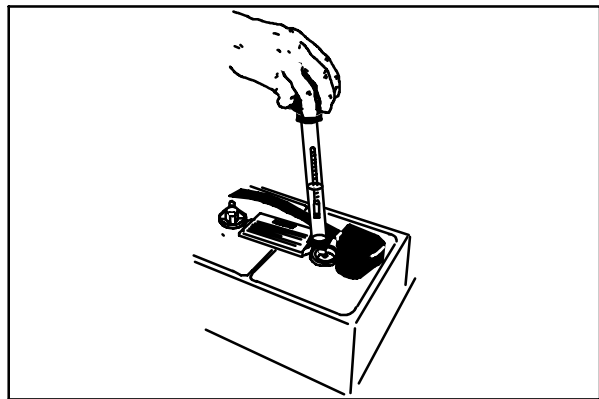

04380

SPECIFIC GRAVITY at 27° C (80° F)	BATTERY CHARGE
1.265	100% Charged
1.223	75% Charged
1.185	50% Charged
1.148	25% Charged
1.110	Discharged

*NOTE: If the readings are taken when the battery electrolyte is any temperature other than 27° C (80° F), the reading must be temperature corrected. Add or subtract to the specific gravity reading 0.004, 4 points, for each 6° C (10° F) above or below 27° C (80° F).*

**CHARGING THE BATTERIES**

1. Drive the machine to a flat, dry surface in a well-ventilated area.
2. Turn the machine power off and set the parking brake if your machine has this option.

## MAINTENANCE

**FOR SAFETY: Before leaving or servicing machine, stop on level surface, and turn off machine.**

3. Lift up the solution tank to get access to the batteries.

*NOTE: The solution tank must be empty.*



4. Check the water level in all the battery cells.

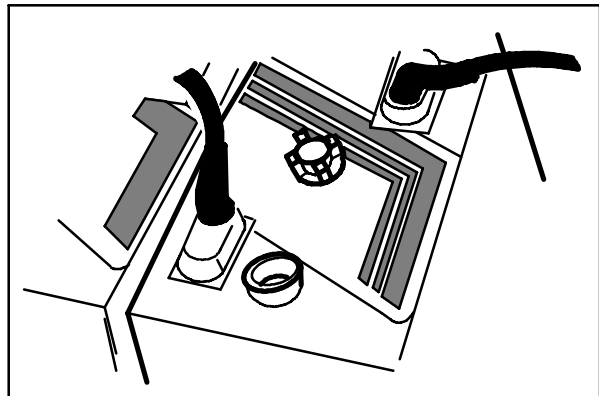

00879

5. If the level is low, add just enough distilled water to cover the battery plates. DO NOT OVERFILL. The batteries can overflow during charging due to expansion.

*NOTE: Make sure the battery caps are in place while charging.*

**FOR SAFETY: When maintaining or servicing machine, avoid contact with battery acid.**

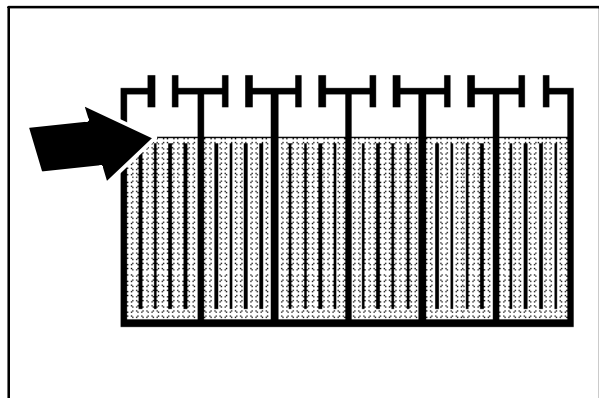

6. Plug the charger connector into the battery connector.



**WARNING: Batteries emit hydrogen gas. Explosion or fire can result. Keep sparks and open flame away. Keep covers open when charging.**

7. Plug the battery charger into the wall outlet.

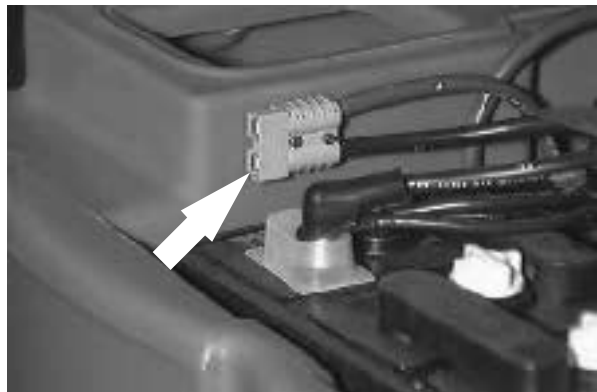

*NOTE: If the red "ABNORMAL CYCLE" lamp lights when the TENNANT charger is plugged into a wall outlet, the charger cannot charge the battery and there is something wrong with the battery.*

8. The TENNANT charger will start automatically. When the batteries are fully charged, the TENNANT charger will automatically turn off.
9. After the charger has turned off, unplug the charger from the wall outlet.
10. Unplug the charger connector from the battery connector on the machine.

**FOR SAFETY: When maintaining or servicing machine, avoid contact with battery acid.**

11. Check the electrolyte level in each battery cell after charging. If needed, add distilled water to raise the electrolyte level to about 12 mm (0.4 in) below the bottom of the sight tubes.
12. Lower the solution tank.
13. Pull up on the support arm and rotate the stop arm out of the way to allow the solution tank to close completely.



---

## **ELECTRIC MOTORS**

---

The carbon brushes on the vacuum fan motor should be inspected after every 500 hours of machine operation. The carbon brushes on the scrub brush motors and propelling motor should be inspected after every 1000 hours of machine operation.

## SCRUB HEAD

The machine can be equipped with either a disk brush, or cylindrical brush scrub head. Both scrub heads contain skirts to control over-spray from the scrub brushes.

### DISK BRUSH SCRUB HEAD SKIRT

Make sure the scrub head skirt touches the floor all the way around when the scrub head is lowered. Check the skirt for damage or wear daily.

### ADJUSTING THE SCRUB HEAD SKIRT

1. Lower the scrub head on a level floor.
2. Turn the machine power off.

**FOR SAFETY: Before leaving or servicing machine, stop on level surface, and turn off machine.**

3. Check to see if the scrub head skirt touches the floor all the way around the scrub head.



4. If the skirt needs to be adjusted, pull the strap end away from the skirt. Loosen the strap from the buckle, and move the skirt up or down to touch the floor.

*NOTE: Replace the scrub head skirt when it is damaged or no longer is able to touch the floor.*

5. Pull the strap tight through the buckle, and attach the strap end to the skirt using the hook and loop fastener.
6. Raise the scrub head.



**REPLACING THE SCRUB HEAD SKIRT**

1. Lower the scrub head.
2. Turn the machine power off.

**FOR SAFETY: Before leaving or servicing machine, stop on level surface, and turn off machine.**

3. Pull the strap end away from the skirt.  
Loosen and pull the strap from the buckle.



4. Pull the old skirt off the scrub head.
5. Put the new skirt on the scrub head, lining up the notches under the rollers.
6. Pull the strap tight through the buckle, and attach the strap end to the skirt using the hook and loop fastener.
7. Adjust the skirt as stated in *ADJUSTING THE SCRUB HEAD SKIRT*.

## MAINTENANCE

---

### CYLINDRICAL BRUSH SCRUB HEAD SKIRTS

The four head skirts should just touch the floor. Check the skirts for damage or wear daily.

### ADJUSTING THE SCRUB HEAD SKIRTS

1. Lower the scrub head on a level floor.
2. Turn the machine power off.

**FOR SAFETY: Before leaving or servicing machine, stop on level surface, and turn off machine.**

3. Check to see if the scrub head skirts touch the floor.
4. If any of the skirts needs adjusting, loosen the retainer strip hardware and slide the skirt to the proper adjustment. Tighten the retainer strip hardware.

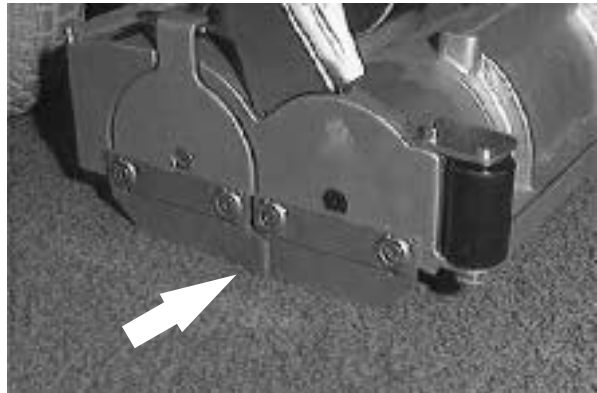

### REPLACING THE SCRUB HEAD SKIRTS

1. Raise the scrub head.
2. Turn the machine power off.

**FOR SAFETY: Before leaving or servicing machine, stop on level surface, and turn off machine.**

3. Remove the retainer strip and hardware.
4. Replace the old skirt with a new skirt and mount in place with the retainer strip and hardware.

**REMOVING OR REPLACING THE SCRUB HEAD**

The scrub heads are available in two brush types, and three widths. The scrub heads are interchangeable when the scrub brush motor circuit breakers, installed in the operator console, match the circuit breakers needed as shown in the following chart:

**SCRUB HEAD/CIRCUIT BREAKERS**

Scrub head	Disk	HD Disk	Cylindrical
Model 700 700 mm (28 in)	20 A	-	20 A
Model 800 800 mm (32 in)	20 A	35 A	20 A
Model 900 900 mm (36 in)	-	35 A	20 A

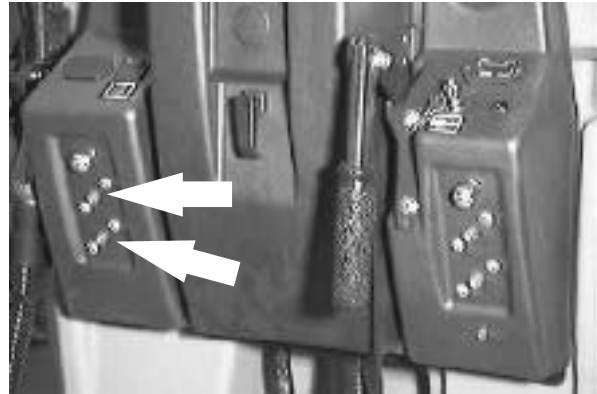

*NOTE: To interchange the model 800 or the model 900 heavy duty disk head with one of the other available scrub heads, you must change the scrub brush motor circuit breakers in the operator console. Interchanging the scrub heads without changing the scrub brush motor circuit breakers will cause the scrub brush motors or circuit breakers to fail.*

*NOTE: When you change to a different width scrub head, be sure to install the appropriate width squeegee and machine front cover.*

1. Lower the scrub head.
2. Turn the machine power off.

**FOR SAFETY: Before leaving or servicing machine, stop on level surface, and turn off machine.**

3. Remove the machine front cover.



## MAINTENANCE

4. Disconnect the solution line from the scrub head tee fitting.

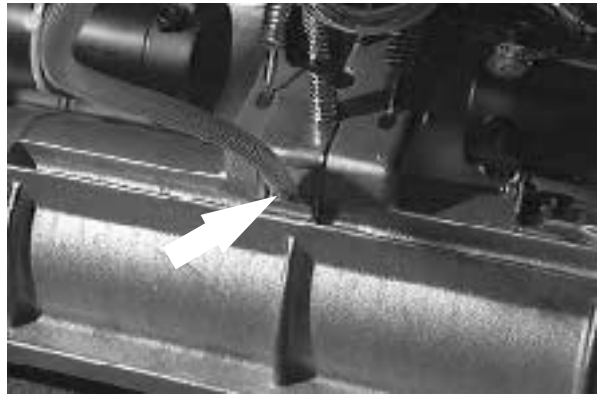

5. Disconnect the wire harness.



6. Disconnect the scrub head from the guide by removing the clevis pin.

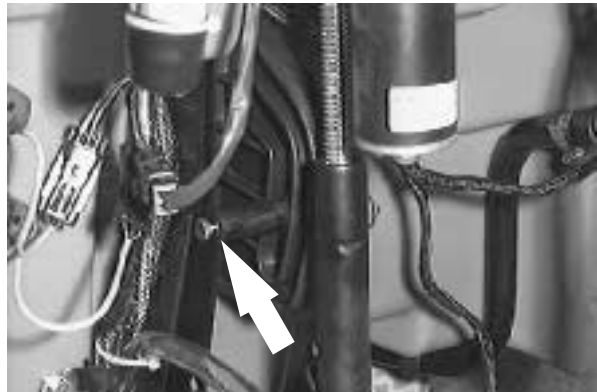

7. Disconnect the lift arms from the scrub head by removing the two clevis pins.

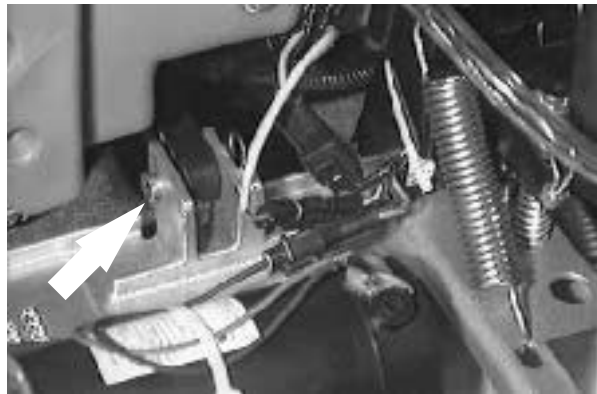



8. Mark the location on the actuator tube on the actuator shaft before disconnecting the actuator. Disconnect the actuator from the scrub head by removing the clevis pin.

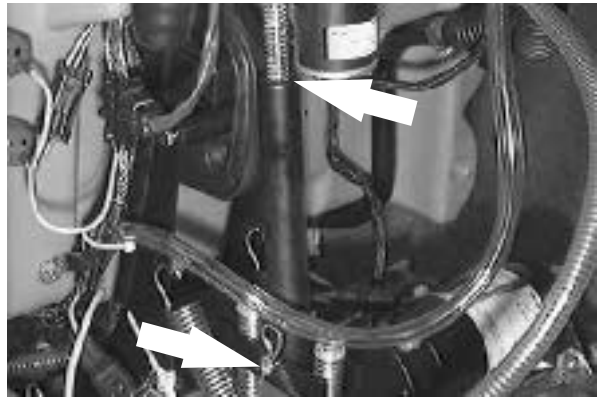

9. To install the scrub head, connect the lift arms to the scrub head with the two clevis pins.
10. Connect the scrub head to the guide with the clevis pin.
11. Make sure the actuator tube lines up with the mark made earlier on the actuator shaft. If not, turn the actuator tube until it does. Connect the actuator to the scrub head with the clevis pin.
12. Connect the wire harness.
13. Connect the solution line to the scrub head tee fitting.

#### LEVELING THE SCRUB HEAD

*NOTE: Check the tires for correct tire pressure before leveling the scrub head.*

1. Make sure the scrub head is lowered to the floor.
2. Check the level of the scrub head by measuring the distance from the top of the scrub head, to the floor at all four corners. The scrub head should measure the same on all four corners.

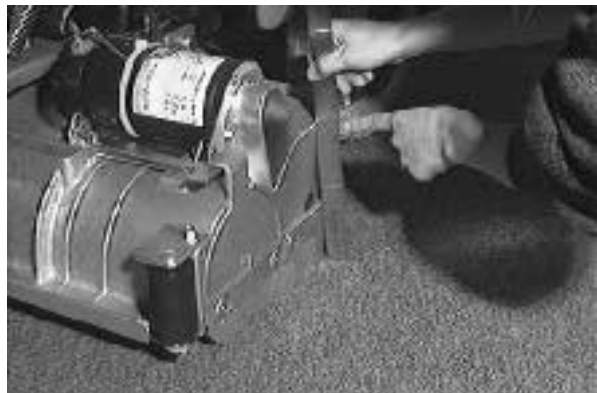

## MAINTENANCE

---

3. If the scrub head is not level at all four corners, loosen the jam nut on the adjustment screw located on the top of the scrub head. Turn the adjustment screw until the scrub head measures level. Tighten the jam nut.
4. Install the machine front cover.
5. Cylindrical scrub head: Check the brush pattern as described in *CHECKING AND ADJUSTING CYLINDRICAL BRUSH PATTERN*.

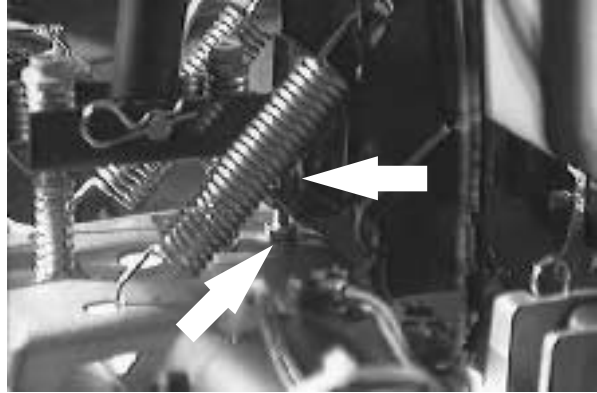

---

## SCRUB BRUSHES

---

The scrub brushes should be checked daily for wire or string tangled around the brush or brush drive hub. The brushes should also be checked for any damage and wear.

## DISK BRUSHES

The disk brushes should be replaced if large amounts of bristles are missing, or if the remaining bristles' length is less than 10 mm (0.38 in).

*NOTE: Be sure to replace brushes in sets. Otherwise one brush will be more aggressive than the other.*

Cleaning pads must be placed on pad drives before they are ready to use. The cleaning pad is held in place by a pad holder.

Cleaning pads need to be cleaned immediately after using with soap and water. Do not wash the pads with a pressure washer. Hang dry pads, or lie flat to dry.

## REPLACING THE DISK BRUSHES

1. Raise the scrub head.
2. Turn the machine power off and set the parking brake if your machine has this option.

**FOR SAFETY: Before leaving or servicing machine, stop on level surface, and turn off machine.**

3. Open the access cover on either corner of the scrub head.

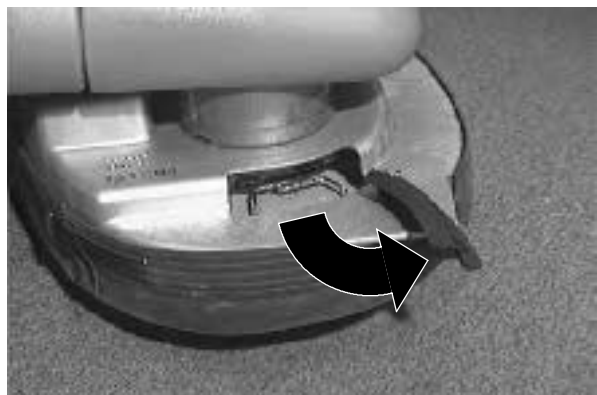

## MAINTENANCE

4. Turn the brush until you can see the brush spring clip.

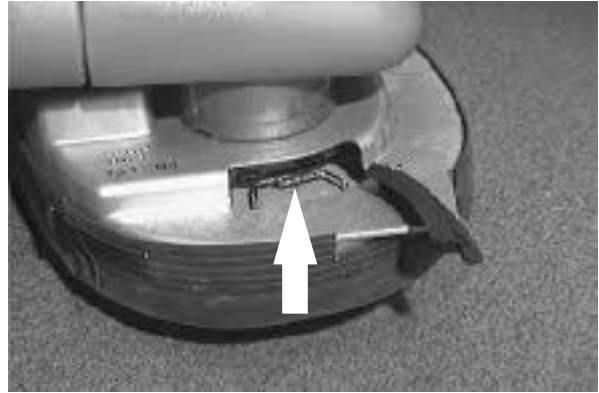

5. Press the brush spring clip together with your thumb and index finger. The brush will drop off the brush drive hub.



6. Pull the brush out from under the scrub head.



7. Place the new scrub brush on the floor in front of the scrub head. Push the brush under the scrub head.

8. Line up the brush drive socket with the drive plug.

9. Lift the scrub brush into the drive plug.

10. Check to make sure the brush is securely mounted on the brush drive hub.

11. Close the scrub head access cover.

12. Repeat for the other brush.



**CYLINDRICAL BRUSHES**

Check the brush taper and rotate the brushes from front-to-rear every 50 hours of operation, for maximum brush life and best scrubbing performance.

The cylinder brushes should be replaced if large amounts of bristles are missing, or if the remaining bristles' length is less than 10 mm (0.38 in).

*NOTE: Be sure to replace brushes in sets. Otherwise one brush will be more aggressive than the other.*

**REPLACING THE CYLINDRICAL BRUSHES**

1. Raise the scrub head.
2. Turn the machine power off and set the parking brake if your machine has this option.

**FOR SAFETY: Before leaving or servicing machine, stop on level surface, and turn off machine.**

3. Push down on the mounting spring and the idler door, then pull out on the bottom of the door. Push down on the spring until the door releases from the scrub head. Pull the idle plug off the brush.



4. Pull the brush out of the scrub head.
5. With the double row end of the brush towards you, guide the brush onto the drive hub.



*NOTE: Use the double rows on the idler end of the brush.*

## MAINTENANCE

6. Insert the Idler plug of the idler door into the brush.

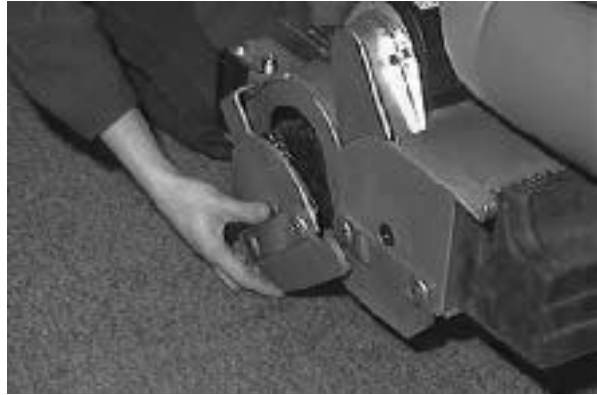

7. Push down on the door to catch the door in the scrub head, then pull up on the door to latch it in the spring.
8. Repeat for the other brush on the other side of the scrub head.

*NOTE: The idler doors have stamped letters that correspond with letters on the scrub head. Make sure the idler doors are placed back on the same side of the scrub head that they were originally removed from.*



### CHECKING AND ADJUSTING CYLINDRICAL BRUSH PATTERN

*NOTE: Check the tires for correct tire pressure and make sure the solution tank is full before checking or adjusting the brush pattern.*

1. Apply chalk, or some other material that will not blow easily away, to a smooth, level floor.
2. Raise the scrub head. Position the scrub head over the chalked area.
3. Set the parking brake if your machine has this option.
4. Lower the scrub head for 15 to 20 seconds while keeping the scrub head in one spot in the chalked area.

*NOTE: If chalk or other material is not available, allow the brushes to spin on the floor for two minutes. A polish mark will remain on the floor.*

5. Raise the scrub head and move the machine away from the chalked area. Turn the machine power off.

6. Observe the shape of the brush patterns. If the brush patterns have parallel sides, the brushes do not need taper adjustment.

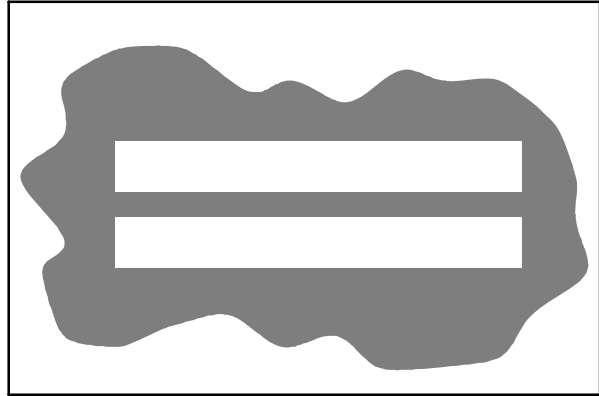

10355

If one or both of the brush patterns are tapered, the brushes will have to be adjusted to straighten the brush pattern.

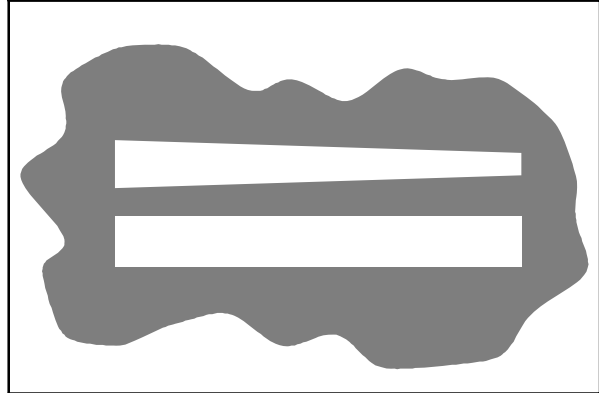

10356

- A. Remove the idler door by pushing down on the mounting spring and the idler door, then pulling out on the bottom of the door. Push down on the spring until the door releases from the scrub head. Pull the idle plug off the brush.



- B. While holding the flat end of the idler shaft with a wrench, loosen the mounting screw on the outside of the idler door.



## MAINTENANCE

- C. Turn the idler shaft to raise or lower the end of the brush as needed to straighten the brush pattern. Tighten the mounting screw.
- D. Check the brush patterns again and readjust as necessary.

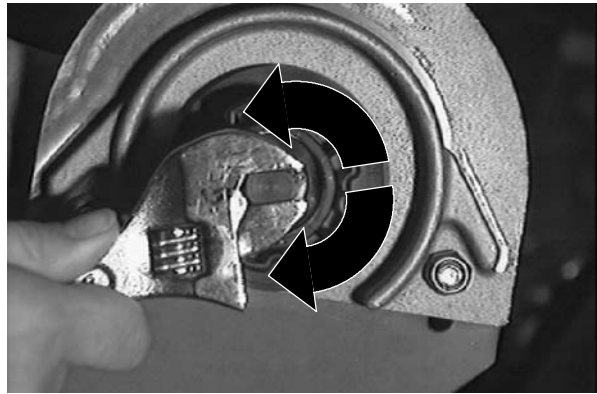

The brush patterns should be the same width. If one is narrower than the other, loosen the jam nut on the adjustment screw located on the top of the scrub head.

Turn the adjustment screw clockwise to increase the front brush pattern width. Turn the adjustment screw counter-clockwise to increase the back brush pattern width. Check the brush patterns again. Adjust until the front and back patterns are the same width.

Tighten the jam nut.

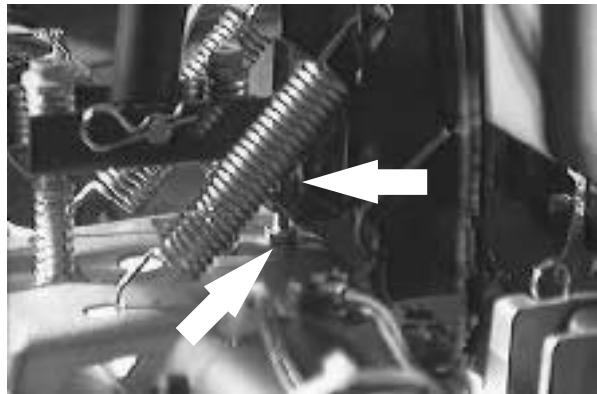

---

## SOLUTION SYSTEM

---

### RECOVERY TANK

The recovery tank stores recovered solution. The recovery tank should be drained and cleaned daily. The outside of the tank can be cleaned with vinyl cleaner.

Rinse and wipe off the level sensors daily. The level sensors are located inside the recovery tank.





ES option: The ES filter should be cleaned daily.

*NOTE: Do not use steam to clean the tank.*

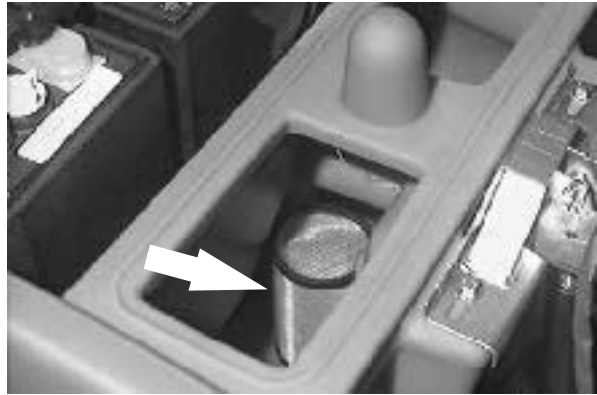

A vacuum fan filter is located in the recovery tank, for machines serial number 006956 and above. Remove and clean this filter daily. Clean by shaking dust or rinsing pleats with low pressure water. For machines below serial number 006956, a screen is located in the solution tank.

*NOTE: Be sure the vacuum filter is dry before reinstalling it in the machine.*



**SOLUTION TANK**

The solution tank stores the cleaning solution.

The solution tank does not require regular maintenance. If deposits form on the bottom of the tank, rinse the tank with a strong blast of warm water. The tank can be flushed through the fill opening and top access hole.

ES option: The solution tank should be drained and cleaned daily.

The solution tank contains one standard solution line filter, and one solution line filter for the power wand option. If the filters become dirty, the solution flow will be reduced. Check and clean these filters if necessary.

*NOTE: Do not use steam to clean the tank.*

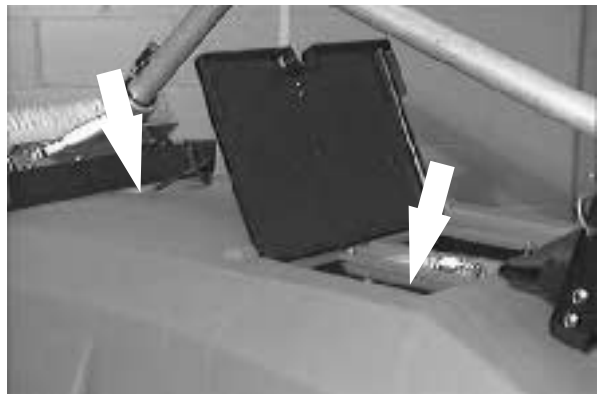

A vacuum fan screen is located in the solution tank, for machines below serial number 006956. Remove and clean this screen daily. For machines serial number 006956 and above, a filter is located in the recovery tank.



### FaST SYSTEM (OPTION)

#### FaST SYSTEM FILTER SCREEN

The FaST system filter screen is located under the solution tank and filters the water from the solution tank as it flows into the FaST system.

Remove the filter screen bowl and clean the filter screen after every 50 hours of machine operation. Empty the solution tank before removing the filter.



#### FaST SUPPLY HOSE CONNECTOR

The FaST supply hose connector is located below the FaST PAK holder. Soak the connector in warm water if detergent buildup is visible. When a FaST PAK carton is not installed, store the supply hose connector on the storing plug to prevent the hose from clogging.



#### FaST SYSTEM AIR PUMP FILTER

The FaST system air filter is located on top of the air pump.

Remove and clean out the air filter with compressed air after every 200 hours of FaST scrubbing.

**FOR SAFETY: When servicing machine, stop on level surface, wear eye protection when using pressurized air.**

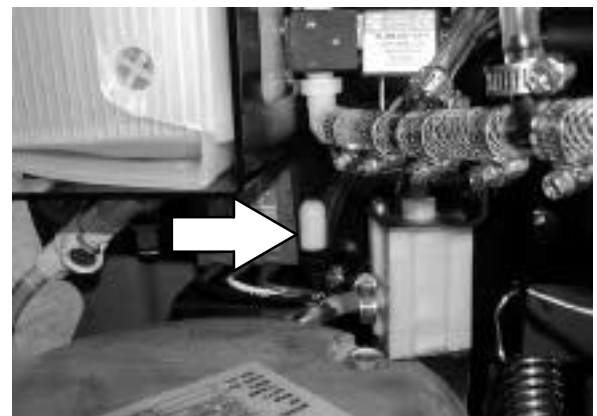

---

## SQUEEGEE

---

The squeegee assembly channels water into the vacuum fan suction. The front blade channels the water, and the rear blade wipes the floor.

Check the squeegee blades for damage and wear daily. Rotate or replace either of the squeegee blades if the leading edge is torn or worn half-way through the thickness of the blade.

The squeegee can be adjusted for leveling and deflection. The deflection and leveling of the squeegee blades should be checked daily, or when scrubbing a different type of floor.

The squeegee assembly can be removed from the squeegee pivot to prevent damage during transport of the machine, or when changing to a different squeegee width. The squeegees are available in three widths to be used with the three different model scrub heads; model 700 (700 mm (28 in)), model 800 (800 mm (32 in)), and model 900 (900 mm (36 in)).

### REMOVING THE SQUEEGEE ASSEMBLY

1. Raise the squeegee.
2. Turn the machine power off and set the parking brake if your machine has this option.

**FOR SAFETY: Before leaving or servicing machine, stop on level surface, and turn off machine.**

3. Remove the squeegee suction hose from the squeegee.



## MAINTENANCE

4. Loosen the two mounting knobs.
5. Pull the squeegee off the machine.

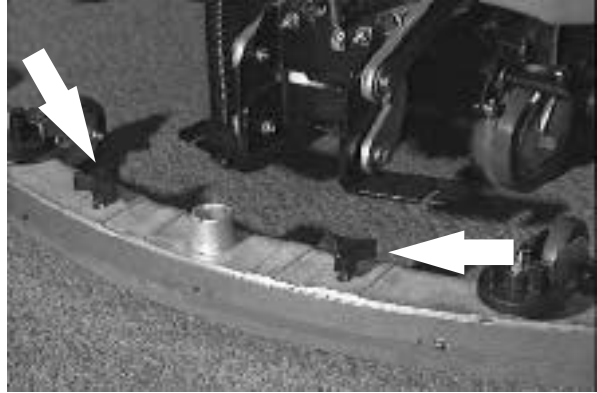

### INSTALLING THE SQUEEGEE ASSEMBLY

1. Make sure the squeegee is raised.
2. Place the squeegee under the squeegee pivot.
3. Slide the squeegee frame onto the squeegee pivot.
4. Tighten the mounting knobs.
5. Push the squeegee suction hose on the squeegee.



### LEVELING THE SQUEEGEE

Leveling of the squeegee assures even contact the length of the squeegee blade with the surface being scrubbed. Make sure this adjustment is done on an even, level floor.

1. Turn the machine power on.
2. Lower the squeegee.
3. Drive the machine forward, then turn the machine power off.
4. Look at the deflection of the squeegee blade, over the full length of the squeegee blade.



5. If the deflection is not the same over the full length of the blade, turn the squeegee leveling knob counter-clockwise to increase the deflection at the ends of the squeegee.

Turn the squeegee leveling knob clockwise to decrease the deflection at the ends of the squeegee blade.

6. Drive the machine forward again with the squeegee down to check the squeegee blade deflection.
7. Readjust the squeegee blade deflection if necessary.



**ADJUSTING SQUEEGEE BLADE DEFLECTION**

Deflection is the amount of curl the squeegee blade has when the machine moves forward with the squeegee lowered to the floor. The best deflection is when the squeegee wipes the floor just dry with a minimum amount of deflection.

1. Turn the machine power on.
2. Lower the squeegee.
3. Drive the machine forward, and look at the deflection of the squeegee blade. The correct amount of deflection is 12 mm (0.50 in) for scrubbing smooth floors and 15 mm (0.62 in) for rough floors.

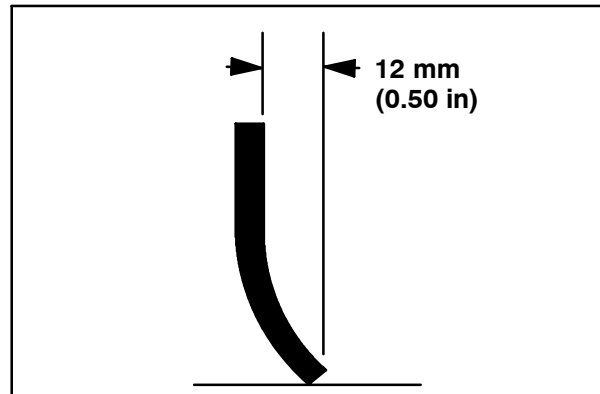

03719

4. Turn the machine power off.
5. To adjust the amount of deflection, turn the squeegee deflection cams counter-clockwise to decrease the blade deflection.

Turn the squeegee deflection cams clockwise to increase blade deflection.

6. Drive the machine forward again to check the squeegee blade deflection.
7. Readjust the squeegee blade deflection if necessary.

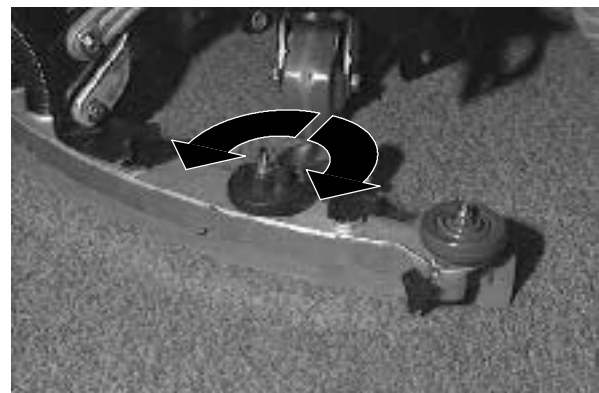

## MAINTENANCE

### ADJUSTING THE SQUEEGEE GUIDE ROLLERS

At each end of the squeegee are guide rollers to guide the squeegee blade end along a wall. Loosen the nut at the top of the guide roller and move the roller in or out to adjust how close the end of the squeegee blade comes to the wall. The squeegee blade end should be further away from the wall when the floor curves up into the wall.

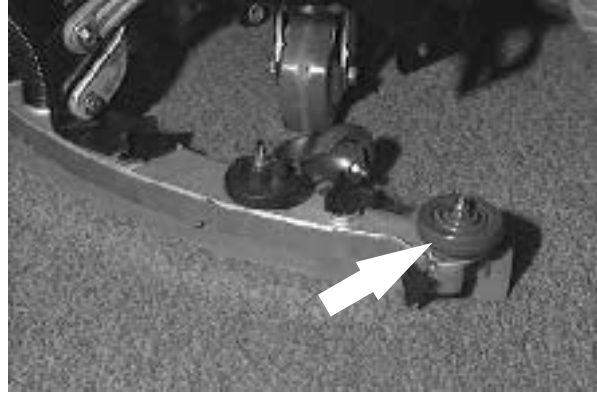

---

### SQUEEGEE BLADES

---

The squeegee has two squeegee blades, the front and back. Each blade has four wiping edges. To use them all, start with one wiping edge. To use the next wiping edge, rotate the blade end-for-end. To use the next wiping edge, rotate the top edges down, bottom edges up. To use the last edge, rotate the blade end-for-end.

Replace any worn or damaged squeegee blades.

### REPLACING OR ROTATING THE REAR SQUEEGEE BLADE

1. Make sure the squeegee is raised off the floor.
2. Turn the machine power off and set the parking brake if your machine has this option.

**FOR SAFETY: Before leaving or servicing machine, stop on level surface, and turn off machine.**

3. Loosen the two retention knobs, one at each end on the squeegee.

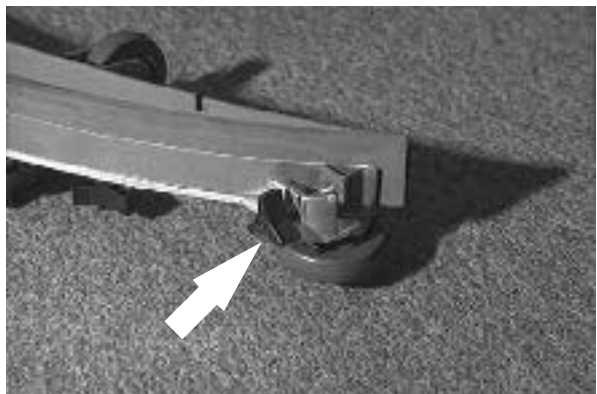

4. Pull off the rear retaining band.



5. Pull off the rear squeegee blade.
6. Insert the rotated or new squeegee blade and then insert the retainer band.
7. Tighten the two retention knobs until the ends of the front and rear squeegee blades touch. Do not overtighten.



**REPLACING OR ROTATING THE FRONT SQUEEGEE BLADE**

1. Make sure the squeegee is raised off the floor.
2. Turn the machine power off and set the parking brake if your machine has this option.

**FOR SAFETY: Before leaving or servicing machine, stop on level surface, and turn off machine.**

3. Remove the squeegee from the machine. See *REMOVING THE SQUEEGEE ASSEMBLY*.
4. Remove the rear squeegee blade and retainer. See *REPLACING OR ROTATING THE REAR SQUEEGEE BLADE*.

## MAINTENANCE

5. Loosen the two remaining knobs on top of the squeegee assembly.
6. Pull the retainer plate back and pull out the front squeegee blade of the squeegee frame.
7. Insert the rotated or new squeegee blade in the squeegee frame, lining up the slots in the blade with the tabs on the retainer plate.



8. Push the retainer plate forward. Tighten the two outside knobs on top of the squeegee assembly.
9. Insert the rear squeegee blade and retainer. Tighten the two rear blade retention knobs until the ends of the front and rear squeegee blades touch. Do not overtighten.
10. Install the squeegee assembly on the squeegee pivot. See *INSTALLING THE SQUEEGEE ASSEMBLY*.
11. Adjust the squeegee blade leveling and deflection as stated in *LEVELING THE SQUEEGEE* and *ADJUSTING SQUEEGEE BLADE DEFLECTION*.





**BELTS AND CHAINS**

**BRUSH DRIVE BELT**

The two brush drive belts are located on the cylindrical brush scrub head. The belts drive the cylindrical brushes. Proper **new** belt tension is a 3 mm (0.1 in) deflection from a force of 1.37 to 1.48 kg (3.0 to 3.26 lb) at the belt midpoint.

When reusing an old belt, measure and record the belt tension before removal, so that the belt can be reinstalled at the same tension.

If the old belt tension was not recorded, the recommended force per old belts is 1.03 to 1.14 kg (2.28 to 2.52 lb) with a deflection of 3 mm (0.1 in).

Check the belt tension and wear every 100 hours of operation.

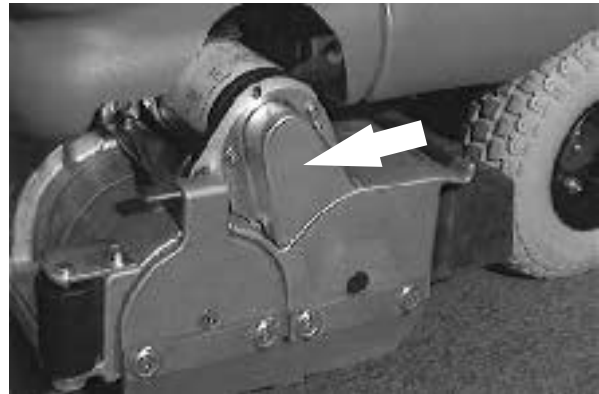

**STATIC DRAG CHAIN**

A static drag chain prevents the buildup of static electricity in the machine. The chain is attached to the transaxle.

Make sure the chain is always touching the floor.

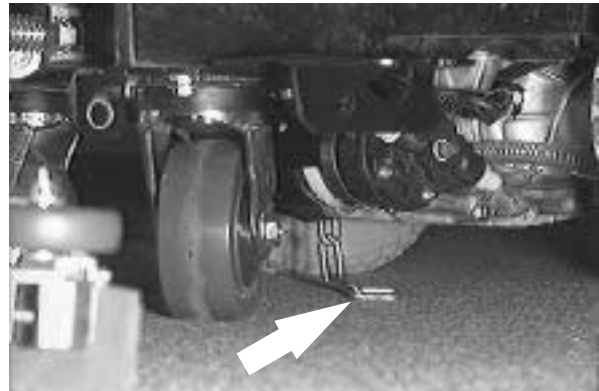

# MAINTENANCE

---

## TIRES

---

The standard front tires are pneumatic.

Check the front tire pressure every 50 hours of operation. The proper tire air pressure is 415 to 450 kPa (60 to 65 psi).

The front wheel lug nuts should be tightened to 102 to 115 Nm (75 to 85 ft lb).

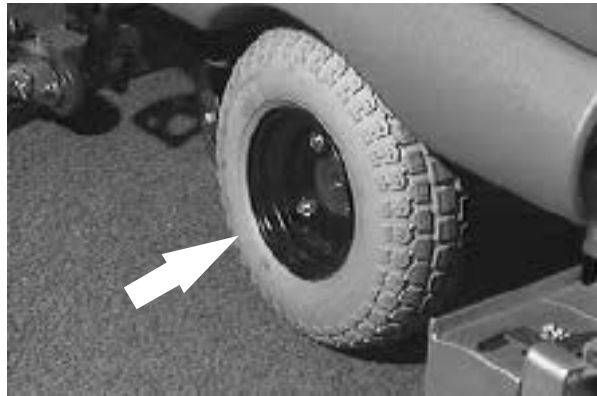

---

## PUSHING AND TRANSPORTING THE MACHINE

---

### PUSHING THE MACHINE

If the machine becomes disabled, it can be pushed if necessary.

Unplug the drive motor from the electrical harness before attempting to push a disabled machine. The machine will become easier to maneuver when it is unplugged.

**ATTENTION! Do not push the machine for a long distance and without unplugging the drive motor or damage may occur to the propelling system.**

Only push a disabled machine for a *very short distance* and do not exceed 3.2 kp/h (2 mph). It is NOT intended to be pushed for a long distance or at a high speed.

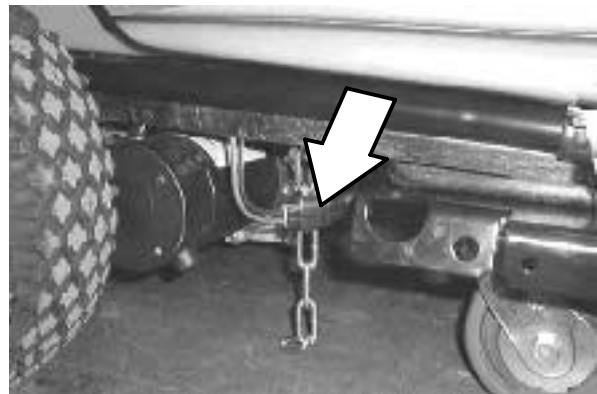

**TRANSPORTING THE MACHINE**

1. Position the rear of the machine at the loading edge of the truck or trailer.

**FOR SAFETY: Use truck or trailer that will support the weight of the machine.**

*NOTE: Empty the recovery and solution tanks before transporting the machine.*

2. If the loading surface is not horizontal or is higher than 380 mm (15 in) from the ground, use a winch to load machine.

If the loading surface is horizontal AND is 380 mm (15 in) or less from the ground, the machine may be pushed onto the truck or trailer.

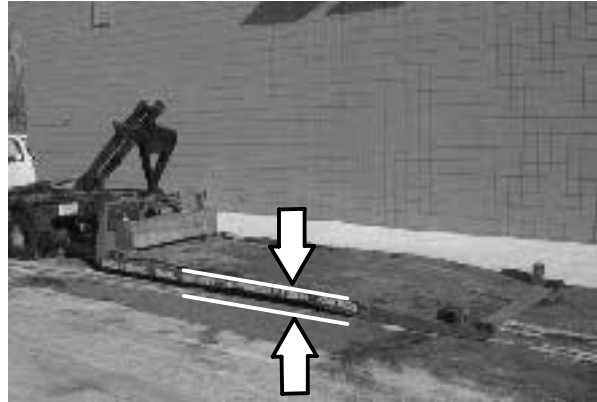

3. To winch the machine onto the truck or trailer, attach the winching chains to the rear tie down locations on either side of the machine frame by the rear casters.

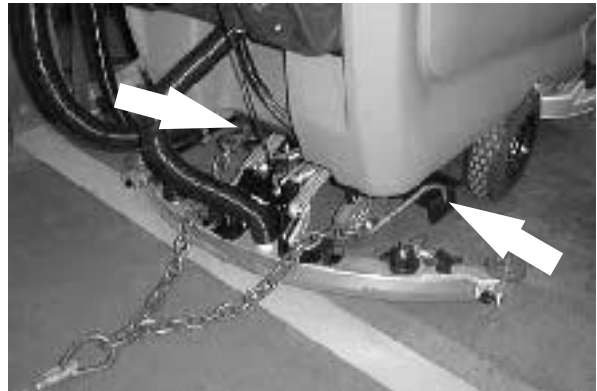

4. Unplug the drive motor from the electrical harness before attempting to winch the machine. The machine will become easier to maneuver when it is unplugged.

**FOR SAFETY: When loading machine onto truck or trailer, use winch. Do not push the machine onto the truck or trailer unless the loading surface is horizontal AND is 380 mm (15 in) or less from the ground.**

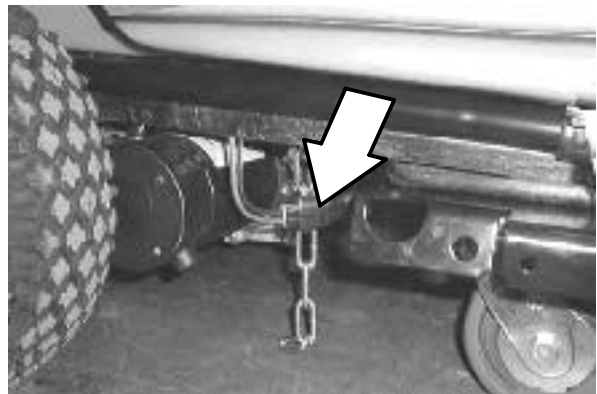

5. Position the machine onto the truck or trailer as far as possible. If the machine starts to veer off the centerline of the truck or trailer, stop and straighten the machine.

## MAINTENANCE

6. Lower the scrub head with the brushes installed, lower the squeegee, and set the machine parking brake, if equipped when transporting the machine. Block the machine tires and tie down the machine to the truck or trailer before transporting.

**NOTE:** *Do not use the steering handles to secure the machine for transport.*

Secure a strap over the top of the machine to prevent the machine from tipping.



The rear tie-down locations are on either side of the machine frame by the rear casters.

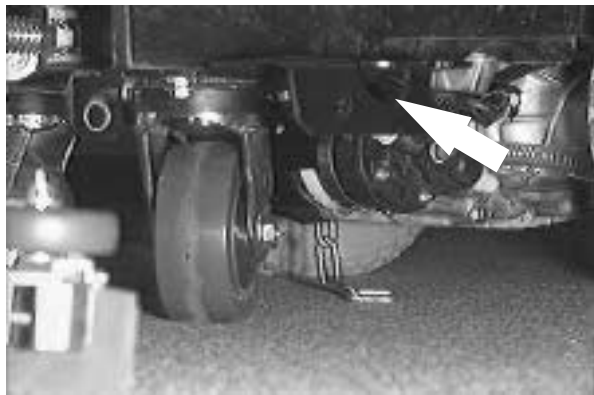

7. If the loading surface is not horizontal or is higher than 380 mm (15 in) from the ground, use a winch to unload machine.

If the loading surface is horizontal AND is 380 mm (15 in) or less from the ground, the machine may be pushed off the truck or trailer.

**FOR SAFETY: When unloading machine off truck or trailer, use winch. Do not push the machine off the truck or trailer unless the loading surface is horizontal AND 380 mm (15 in) or less from the ground.**

---

**MACHINE JACKING**

---

Empty the recovery and solution tanks before jacking the machine. You can jack up the machine for service anywhere under the recovery tank. Use a hoist or jack that will support the weight of the machine. Use a piece of wood to distribute the machine weight load.

Always stop the machine on a flat level surface and block the machine tires before jacking up the machine.

**FOR SAFETY: When servicing machine, block machine tires before jacking machine up.**

**FOR SAFETY: When servicing machine, jack machine up at designated locations only. Block machine up with jack stands.**

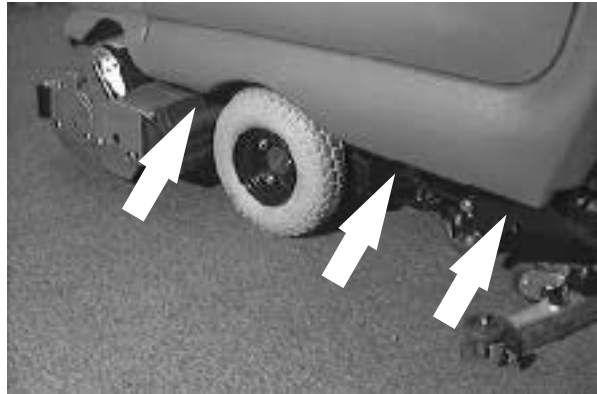

---

**STORAGE INFORMATION**

---

The following steps should be taken when storing the machine for extended periods of time.

1. Drain and clean the solution and recovery tanks.
2. Park the machine in a cool, dry area.
3. Remove the batteries, or charge them after every three months.

**FREEZE PROTECTION**

1. Be sure the solution tank is empty.
2. Pour 3.8 L (1 gal) of pre-mixed automotive-type windshield washer solution into the solution tank.
3. Turn the machine power on.
4. Start the solution flow. Start the power wand solution system or ES™ system to circulate the washer solution through the components.
5. The washer solution does not need to be drained from the solution tank.

## SPECIFICATIONS

### SPECIFICATIONS

#### GENERAL MACHINE DIMENSIONS/CAPACITIES

Item	Dimension/capacity
Length with cylindrical scrub head	1600 mm (63 in)
Length with 700 mm (28 in) disk scrub head	1625 mm (64 in)
Length with 800 mm (32 in) disk scrub head	1660 mm (65.25 in)
Length with 900 mm (36 in) disk scrub head	1690 mm (66.5 in)
Width (less squeegee and scrub head)	720 mm (28.25 in)
Height	1090 mm (43 in)
Disk brush diameter for 700 mm (28 in) scrub head	355 mm (14 in)
Disk brush diameter for 800 mm (32 in) scrub head	405 mm (16 in)
Disk brush diameter for 900 mm (36 in) scrub head	455 mm (18 in)
Cylindrical brush diameter	150 mm (6 in)
Cylindrical brush length for 700 mm (28 in) scrub head	700 mm (28.00 in)
Cylindrical brush length for 800 mm (32 in) scrub head	800 mm (32.00 in)
Cylindrical brush length for 900 mm (36 in) scrub head	900 mm (36.00 in)
Squeegee width for 700 mm (28 in) scrub head	950 mm (37.5 in)
Squeegee width for 800 mm (32 in) scrub head	1070 mm (42 in)
Squeegee width for 900 mm (36 in) scrub head	1160 mm (45.5 in)
Scrubbing path width for 700 mm (28 in) scrub head	700 mm (28 in)
Scrubbing path width for 800 mm (32 in) scrub head	800 mm (32 in)
Scrubbing path width for 900 mm (36 in) scrub head	900 mm (36 in)
Solution tank capacity (recommended usage)	114 L (30 gal)
Solution tank capacity (maximum)	133 L (35 gal)
Recovery tank capacity to full sensor	114 L (30 gal)
Recovery tank capacity to top of tank	152 L (40 gal)
Transaxle 90 weight gear lubricant capacity	1.42 L (1.5 qt)
GVWR	690 kg (1520 lb)

**FaST SYSTEM (OPTION)**

Item	Measure
Solution pump	36 Volt DC, 5A, 5.7 LPM (1.5 GPM) open flow, 45 psi bypass setting
Solution flow rate	0.83 LPM (0.22 GPM)
Detergent pump	36 Volt DC
Concentrate flow rate	0.9 CC/Minute (0.03 Ounces/Minute)
Concentrate to water dilution ratio	1:1000
Air pump	36 Volt DC, 0.6 Maximum Amp draw
Air pump flow rate	8.7 LPM (0.3 CFM) open flow

**GENERAL MACHINE PERFORMANCE**

Item	Measure
Aisle turnaround width with 700 mm (28 in) scrub head	1680 mm (66.25 in)
Aisle turnaround width with 800 mm (32 in) scrub head	1700 mm (67 in)
Aisle turnaround width with 900 mm (36 in) scrub head	1725 mm (67.5 in)
Maximum rated climb and descent angle with empty tanks	8°
Maximum rated climb and descent angle with full tanks	6°

## SPECIFICATIONS

### POWER TYPE

Type	Quantity	Volts	Ah Rating	Weight
Batteries	6	6	235 @ 20 hr rate	30 kg (67 lb)
	6	6	335 @ 20 hr rate	47 kg (104 lb)

Type	Use	VDC	Kw (hp)
Electric Motors	Scrub brush (disk)	36	0.45 (0.60)
	Heavy duty scrub brush (disk)	36	0.75 (1)
	Scrub brush (cylindrical)	36	0.56 (0.75)
	Vacuum fan	36	0.63 (0.85)
	Propelling	36	0.37 (0.50)

Type	VDC	amp	Hz	Phase	VAC
Chargers (Smart)	36	20	60	1	115
	36	30	60	1	115
Chargers (International)	36	20	50	1	230
	36	20	50	1	245
	36	30	50	1	230
	36	30	50	1	245

### TIRES

Location	Type	Size	Pressure
Front (2)	Pneumatic	4.10/3.5 - 6	415 to 450 kPa (60 to 65 psi)
Front (2)	Solid (option)	1.2/3.0-6	-
Rear, casters (2)	Solid, non-marking	5 x 2 in	-



# SPECIFICATIONS

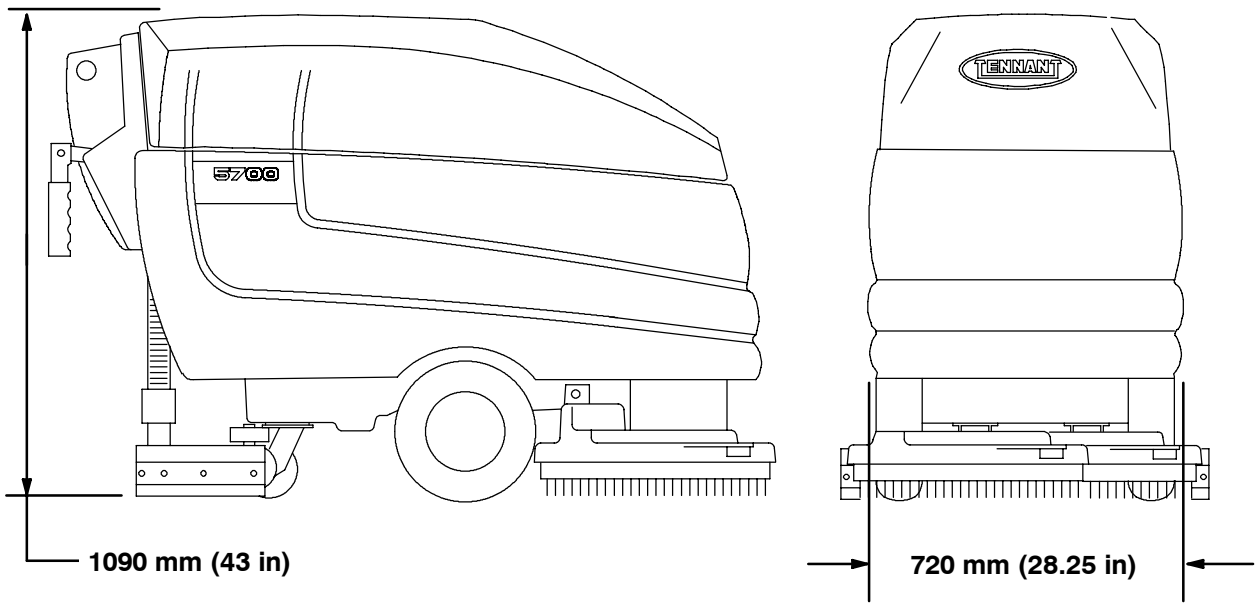
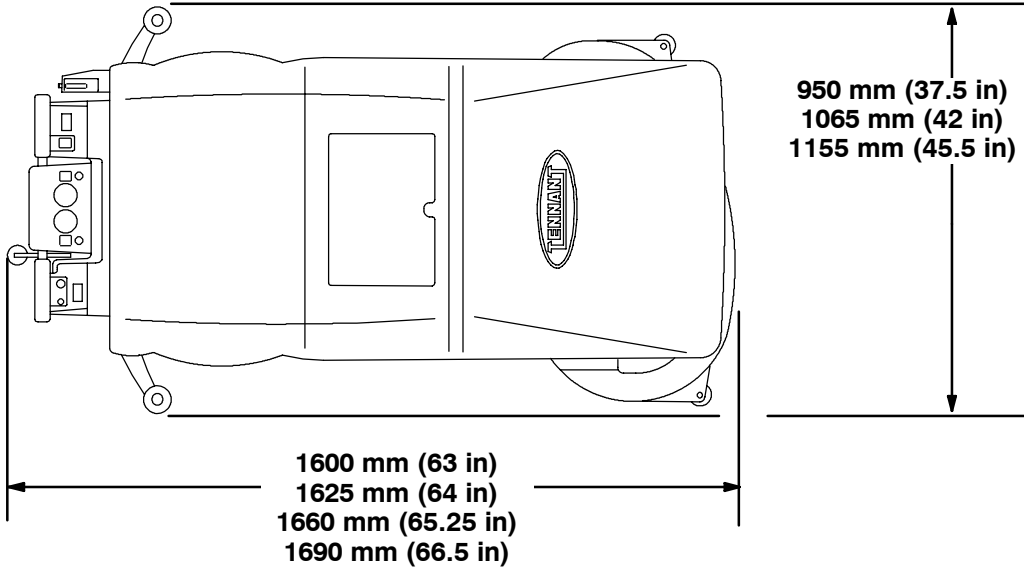

**MACHINE DIMENSIONS**

10189

**A**

Adjusting brush pattern, Cylindrical, 68–70  
Adjusting squeegee deflection, 75  
Adjusting squeegee guide rollers, 76  
Aisle turn, 85

**B**

Batteries, 54–56  
  Charger specifications, 86  
  Charging, 55–57  
  Discharge indicator, 12  
  Maintenance, 54  
  Specifications, 86  
Battery, Fluid level, 22, 39  
Battery discharge indicator, 12  
Belts, 79  
  Brush drive belt, 79  
Brakes, Parking, 19  
Brush, 39  
  Pressure gauge, 12  
Brush pressure gauge, 12  
Brushes, 65–70  
  Cylindrical, 67  
    Adjusting pattern, 68–70  
  Disk, 65  
  Light, 13  
  Maintenance, 22, 39  
  Scrubbing, 28  
  Switch, 13

**C**

Cams, Squeegee down pressure, 19  
Capacities, 84  
Chains, 79  
  Static drag, 79  
Circuit breakers, 16  
  Scrub brushes, 61

Controls, 8  
  Battery discharge indicator, 12  
  Brush pressure gauge, 12  
  Circuit breakers, 16  
  ES switch, 12  
  FaST switch (option), 11  
  Fuse, 17  
  Height adjustment latch, 10  
  Hourmeter, 14  
  Machine on light, 14  
  On-off key switch, 14  
  Power kill switch, 15  
  Power wand switch, 10  
  Recovery tank full light, 11  
  Scrub brushes down light, 13  
  Scrub brushes switch, 13  
  Solution flow lever, 10  
  Squeegee down pressure cams, 19  
  Squeegee leveling knob, 19  
  Squeegee lever, 15  
  Steering handles, 9  
  Symbols, 7  
Cylindrical brushes  
  Adjusting scrub head skirt, 60  
  Replacing scrub head skirts, 60  
Cylindrical scrub head, Debris trough, 37

**D**

Debris tray, Clean, 22, 39  
Debris trough, 37  
Dimensions, 84  
Disk brushes  
  Adjusting the scrub head skirt, 58  
  Replacing scrub head skirt, 59  
Double scrubbing, 31  
Draining and cleaning the tanks, 33–37

**E**

Electric motors, 57, 86  
 Electrical  
   Batteries, 54–56  
   Charging batteries, 55–57  
   Circuit breakers, 16  
 Electrical system, Fuse, 17  
 ES  
   Clean tanks, 22, 39  
   Detergent level, 22, 39  
   Draining and cleaning tanks, 34  
   Filling tanks, 26  
 ES switch, 12

**F**

FaST, System, 72  
 FaST pak agent (option), Installing, 23–25  
 FaST pak agent installation, 23–25  
 FaST Supply Hose Connector, 72  
 FaST switch (option), 11  
 FaST System, 72  
 FaST system (option), 21  
 FaST System Air Pump Filter, 72  
 FaST System Filter Screen, 72  
 Filling the tanks, 25–27  
 Filter  
   FaST System Air Pump Filter, 72  
   FaST System Filter Screen, 72  
   Vacuum fan inlet, 22, 39  
 Freeze protection, 83  
 Front wheel, Tires, 80  
 Front wheels, Lug nuts, 80  
 Fuse, 17

**G**

Gauge, Brush pressure, 12  
 Grease fittings, Rear casters, 54

**H**

Hoses  
   Recovery tank drain, 18  
   Solution tank, 17  
 Hourmeter, 14  
 How the machine works, 20

**I**

Installing the squeegee, 74

**J**

Jack points, 83  
 Jacking, 83

**K**

Knob, Speed reduction, 15  
 Knobs, Squeegee leveling, 19

**L**

Latch, Steering height adjustment, 10  
 Leveling the scrub head, 63  
 Leveling the squeegee, 74  
 Levers  
   Parking brake, 19  
   Solution flow, 10  
   Squeegee, 15  
 Lights  
   Machine on, 14  
   Recovery tank full, 11  
   Scrub brushes down, 13  
 Lubrication, 54  
   Rear casters, 54  
   Transaxle, 54  
 Lug nuts, Front wheel, 80

**M**

Machine, Jacking, 83  
 Machine components, 6  
 Machine dimensions, 87  
 Machine tie down location, 82  
 Maintenance, 52–76  
   Intervals, 52  
   Recommended, 5  
 Maintenance chart, 52  
 Motors, Electric, 57, 86

**N**

Normal scrubbing, 28

**O**

On-off key switch, 14  
Operation, 5–42  
Operation on inclines, 38  
Operator Responsibility, 5  
Options, 42–49  
    ES switch, 12  
    FaST pak agent installation , 23–25  
    FaST switch, 11  
    FaST System, 72  
    FaST System specifications, 85  
    Power wand, 46–50  
    Power wand switch, 10  
    Vacuum wand, 42–45

**P**

Parking brake, 19  
Post-operation checklist, 39  
Power kill switch, 15  
Power wand switch, 10  
Pre-operation checklist, 22  
Pushing and transporting machine, 80  
Pushing machine, 80  
Pushing the machine, 80

**R**

Rated incline and descent, 85  
Recovery tank, Drain and clean, 22, 39  
Recovery tank, 70  
    Draining and cleaning, 33–37  
    Full light, 11  
    Hose, 18  
    Optical sensors, Cleaning, 70  
    Sensors, Cleaning, 36  
Recovery tank drain hose, 18  
Recovery tank full light, 11  
Recovery tank optical sensor, 70  
Recovery tank sensor, 36  
Removing or replacing scrub head, 61–63  
Removing the squeegee, 73  
Replacing cylindrical brushes, 67  
Replacing front squeegee blades, 77  
Replacing rear squeegee blades, 76  
Replacing the disk brush, 65

Rotating front squeegee blades, 77  
Rotating rear squeegee blades, 76

**S**

Safety  
    Labels, 4  
    Precautions, 3  
    Stop arm, 18  
    Support arm, 18  
Screen, FaST System Filter Screen, 72  
Scrub brushes, 65–70  
    Cylindrical, 67  
        Adjusting pattern, 68–70  
        Replacing, 67  
    Disk, 65  
        Replacing, 65  
Scrub brushes down light, 13  
Scrub brushes switch, 13  
Scrub head, 58–64  
    Brush drive belt, 79  
    Cylindrical brushes, 60  
        Adjusting skirts, 60  
        Replacing skirts, 60  
    Disk brushes, 58  
        Replacing skirt, 59  
        Skirt adjusting, 58  
    Leveling, 63  
    Removing or replacing, 61–63  
Scrubbing  
    Double, 31  
    Normal, 28  
    Stop, 32  
Scrubbing brushes, 28  
Scrubbing pads, 28  
Seals, Tank Cover, 22, 39  
Sensors  
    Optical, Recovery tank, 70  
    Recovery tank, 36  
Service records, 22, 39  
Skirts  
    Cylindrical brushes, 60  
    Disk brushes, 58  
Solution  
    Filling the tanks, 25–27  
    Flow lever, 10  
    System, 70  
    Tank hose, 17

- Solution flow lever, 10
  - Solution System, 70
  - Solution Tank, 71
  - Solution tank
    - Draining and cleaning, 33–37
    - Filling, 25–27
    - Hose, 17
    - Stop arm, 18
    - Support arm, 18
  - Solution tank hose, 17
  - Specifications, 84–86
    - Chargers, 86
    - Electric motors, 86
    - FaST System, 85
    - Machine capacities, 84
    - Machine dimensions, 84
    - Machine performance, 85
    - Power type, 86
    - Tires, 86
  - Speed reduction knob, 15
  - Squeegee, 73–76
    - Adjustment, 22, 39
    - Blades, 76
      - Replacing or rotating front, 77
      - Replacing or rotating rear, 76
    - Deflection, 22
      - Adjusting, 75
    - Down pressure cams, 19
    - Guide rollers, Adjusting, 76
    - Leveling, 74
    - Leveling knob, 19
    - Lever, 15
  - Squeegee assembly
    - Installing, 74
    - Removing, 73
  - Squeegee blades, 76
  - Squeegee down pressure cams, 19
  - Squeegee leveling knob, 19
  - Squeegee lever, 15
  - Starting the machine, 25
  - Static drag chain, 79
  - Steering handles, 9
    - Height adjustment, 10
  - Stop arm, 18
  - Stop scrubbing, 32
  - Stop the machine, 38
  - Storage information, 83
    - Freeze protection, 83
  - Support arm, 18
  - Switches
    - ES, 12
    - FaST, 11
    - On-off key, 14
    - Power kill, 15
    - Power wand, 10
    - Scrub brushes, 13
- T**
- Tanks
    - Recovery, 70
    - Solution, 71
  - Tie down location, 82
  - Tires, 80–81
    - Pressure, 80
    - Specifications, 86
  - Transaxle, 54
  - Transporting machine, 80
  - Transporting the machine, 81
  - Troubleshooting, 40
- V**
- Vacuum wand, 42–45

