

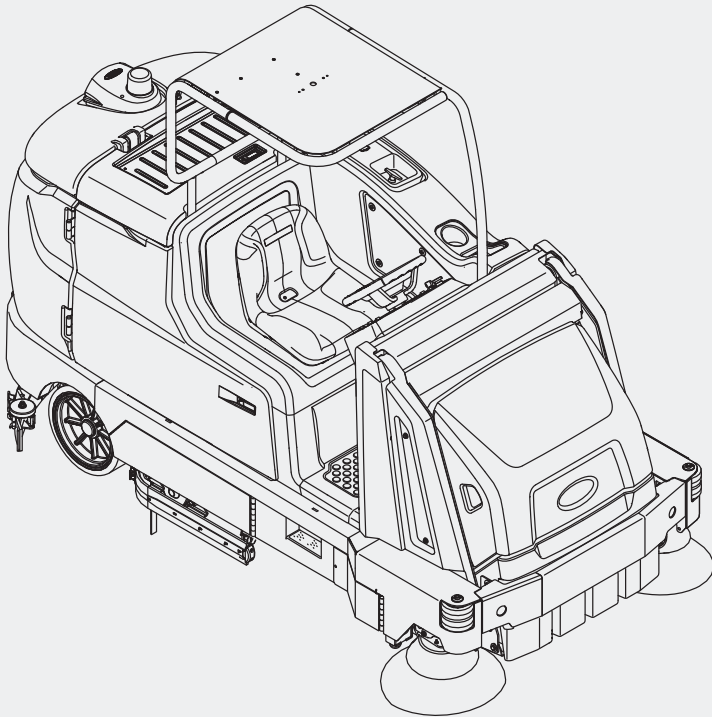

M17

(Battery)

Sweeper Scrubber Operator Manual



ES[®] Extended Scrub System
Tennant True[®] Parts
IRIS[®] a Tennant Technology
Pro-Panel[™] Controls
Insta-Fit[™] Adapter



North America / International



For the latest Parts Manuals and other
language Operator Manuals, visit:

www.tennantco.com/manuals

9017351
Rev. 03 (5-2017)



INTRODUCTION

This manual is furnished with each new model. It provides necessary operation and maintenance instructions.



Read this manual completely and understand the machine before operating or servicing it.

This machine will provide excellent service. However, the best results will be obtained at minimum costs if:

- The machine is operated with reasonable care.
- The machine is maintained regularly - per the machine maintenance instructions provided.
- The machine is maintained with manufacturer supplied or equivalent parts.

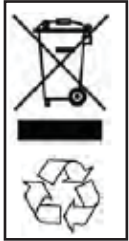

PROTECT THE ENVIRONMENT

Please dispose of packaging materials, used components such as batteries and fluids in an environmentally safe way according to local waste disposal regulations.

Always remember to recycle.

MACHINE DATA

Please fill out at time of installation for future reference.

Model No. - _____

Serial No. - _____

Installation Date - _____

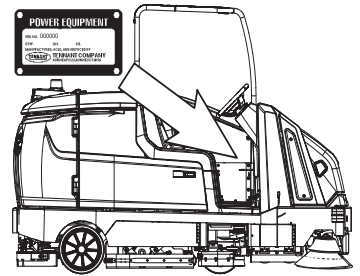

INTENDED USE

The M17 is an industrial rider machine designed to wet scrub and sweep both rough and smooth hard surfaces (concrete, tile, stone, synthetic, etc). Typical applications include schools, hospitals / health care facilities, office buildings, and retail centers. Do not use this machine on soil, grass, artificial turf, or carpeted surfaces. This machine is intended for indoor use only. This machine is not intended for use on public roadways. Do not use this machine other than described in this Operators Manual.

Tennant Company

PO Box 1452
Minneapolis, MN 55440
Phone: (800) 553-8033
www.tennantco.com

DFS (Dual Force Sweeping), PerformanceView, Pro-ID, Pro-Check, Perma-Filter, ShakeMax, Zone Settings, SmartRelease, QA Controls, 1-Step, Dura-Track, Touch-N-Go, Duramer, are trademarks of Tennant Company.

Specifications and parts are subject to change without notice.

Original Instructions, copyright® 2016, 2017 TENNANT Company, Printed in U.S.A.

CONTENTS

Contents	3	Pre-Operation Checklist	33
Important Safety Instructions - Save These Instructions	7	Operation Of Controls - All Machines.....	34
For Safety:	7	Emergency Shut-Off Button	34
Operation.....	12	Directional Switch.....	34
Machine Components	12	Operating / Hazard Light Switch (Option)	34
Controls And Instruments.....	13	Propel Pedal.....	35
Standard Control Panel.....	14	Brake Pedal.....	35
Pro-Panel Controls.....	15	Parking Brake Pedal	35
Symbol Definition	16	Operator Seat.....	35
Operation Of Controls - Standard Panel	19	Seat Belts (Deluxe Seat Option Only).....	35
Battery Discharge Indicator.....	19	Rear Bumper Door / Step.....	36
Hour Meter	19	How The Machine Works	37
Recovery Tank Full Indicator	19	Brush And Pad Information	38
Solution Tank Indicator.....	19	While Operating The Machine.....	39
Contrast Control Button.....	20	Pre-Operation Checklist.....	40
Configuration Mode Button	20	Starting The Machine	41
1-Step Button	20	Filling The Detergent Tank (Option)	41
Sweeping Side Brush Button	21	Filling The Solution Tank	42
Sweeping Vacuum Fan Button.....	21	Conventional Scrubbing Mode.....	42
Sweeping Main Brush Button.....	21	Ec-H2o Scrubbing (Ec-H2o Mode).....	42
Scrubbing Side Brush Button (Option)	21	Es (Extended Scrub) Mode -	
Scrubbing Vacuum Fan / Squeegee Button.....	22	Manual Tank Fill	43
Scrubbing Main Brush Button	22	Auto-Fill (Option)	43
Solution On / Off Button	22	Ec-H2o Button (Option)	44
Severe Environment Switch (Option).....	23	Es (Extended Scrub) Button (Option)	45
Filter Shaker Switch	23	Scrub Brush Pressure	46
Operation Of Controls - Pro-Panel.....	24	Setting The Brush Pressure - Standard Panel	46
Pro-Id Login Screen	24	Setting The Brush Pressure - Pro-Panel	46
Machine Status Button	24	Solution Flow	47
Changing The Default Button.....	25	Setting The Solution Flow - Standard Panel.....	47
1-Step Button	26	Setting The Solution Flow - Pro-Panel	47
Sweeping Main Brush Button.....	26	Scrubbing / Sweeping - Standard Panel	48
Sweeping Vacuum Fan Button.....	26	Scrubbing / Sweeping - Pro-Panel.....	49
Sweeping Side Brush Button	27	Double Scrubbing	50
Scrubbing Main Brush Button	27	Water Pickup Mode (No Scrubbing).....	52
Scrubbing Vacuum Fan / Squeegee Button.....	27	Stop Cleaning	52
Scrubbing Side Brush Button (Option)	27	Emptying The Hopper	53
Solution On / Off Button	28	Emptying The Hopper - Standard Panel.....	53
Filter Shaker Button	28	Emptying The Hopper - Pro-Panel	54
Severe Environment Button (Option)	28	Engaging The Hopper Support Bar.....	56
Zone Control Buttons	29	Disengaging The Hopper Support Bar.....	56
Rearview Camera Button.....	29	Draining And Cleaning The Recovery Tank ..	57
Help Button	30	Draining And Cleaning The Solution Tank.....	60
Video Help Button	32		
Completing The Pro-Check			

CONTENTS

Turn Off The Machine	61	Inspecting / Cleaning The Perma-Filter....	92
Faults / Alerts	62	Main Scrub Brushes.....	93
Fault / Alert Indicators -		Disk Brushes And Pads.....	93
Standard Panel.....	62	Replacing Disk Scrub Brushes Or Pad	
Fault / Alert Indicators -		Drivers	93
Pro-Panel	62	Replacing Disk Scrub Pads.....	94
Fault / Alert Indicators	63	Cylindrical Scrub Brushes	95
Options.....	64	Replacing Cylindrical Scrub Brushes	95
Spray Nozzle (Option).....	64	Main Sweep Brushes	97
Vacuum Wand (Option).....	65	Replacing The Main Sweeping Brush	97
Slide Out Battery (Option).....	67	Side Brush(Es).....	98
Rear Squeegee Guard (Option).....	68	Replacing The Sweeping Side Brushes...98	
Adjusting Backup Alarm Volume (Option)	68	Adjusting The Sweeping Side Brushes ...98	
Machine Troubleshooting.....	69	To Adjust Sweeping Side Brush -	
Maintenance.....	72	Standard Panel.....	99
Yellow Touch Points	75	To Adjust Sweeping Side Brush -	
Lubrication	75	Pro-Panel	100
Steering Chain	75	Replacing The Scrubbing Side Brush	
Steering Gear Chain	75	(Option)	101
Drive Wheel Pivot.....	75	Squeegee Blades.....	102
Hopper Chains	75	Replacing (Or Rotating) The Rear	
Hopper Lift Arm Pivots	76	Squeegee Blades.....	102
Hopper Chains	76	Leveling The Rear Squeegee	106
Hydraulics	77	Adjusting The Rear Squeegee Blade	
Hydraulic Fluid	78	Deflection	107
Hydraulic Hoses	78	Replacing Or Rotating The Side	
Battery.....	79	Squeegee Blades.....	108
Checking The Electrolyte Level.....	79	Replacing Or Rotating The Scrubbing	
Maintenance-Free Batteries.....	80	Side Brush Squeegee Blades	
Checking Connections / Cleaning.....	80	(Option)	109
Charging The Battery	81	Skirts And Seals.....	111
To Charge With Tennant Branded		Sweeping Recirculation Skirts.....	111
Charger	81	Sweeping Side Skirts	111
To Charge With Energys Battery		Recovery Tank Seal	111
Charger	83	Solution Tank Seal	111
Opportunity Charging (Option).....	85	Scrub Head Skirts	
Weekly Equalization Charge	86	(Disk Scrub Heads Only).....	112
Battery Watering System (Option).....	88	Hopper Dust Filter Seal.....	112
Circuit Breakers, Fuses, And Relays	89	Hopper Seals	112
Circuit Breakers.....	89	Belts	113
Fuses	90	Cylindrical Brush Drive Belts.....	113
Relays	90	Sweeping Brush Drive Belts.....	113
Electric Motors	90	Brakes.....	113
Solution Supply Filter	90	Tires	113
Hopper Dust Filter / Perma-Filter	91	Pushing, Towing, And Transporting The	
Removing / Replacing The Hopper Dust		Machine.....	114
Filter	91	Pushing Or Towing The Machine	114
Cleaning The Hopper Dust Filter.....	92	Transporting The Machine	114
Thermo-Sentry	92		

Unloading The Machine	115
Machine Jacking	116
Ec-H2o Module Flush Procedure	117
Storage Information	119
Freeze Protection	119
Preparing The Machine For Operation After Storage.....	121
Priming The Ec-H2o System.....	123
Specifications	125
General Machine Dimensions/Capacities ...	125
General Machine Performance	126
Power Type	126
Tires	127
Scrubbing Side Brush Solution Flow Rate (Option).....	127
Ec-H2o System (Option).....	127
Machine Dimensions.....	128
Supervisor Controls.....	129
Pro-Panel Supervisor Controls	129
Entering The Supervisor Mode - First Time Use Only.....	129
Entering The Supervisor Mode	130
Supervisor Setting Screen / Screen Icons	131
Adding / Editing Profiles	132
Enabling The Login	134
Disabling The Login	135
Changing Battery Type.....	136
Calibrating The Touch	136
Exporting Checklists.....	137
Checklist Setup	138
Disabling / Enabling The Pre-Operation Checklist.....	139
Changing The Rear View Camera Settings.....	140
Programming The Zone Control Buttons	140
Setting / Changing The Date And Time..	142
Index.....	143

IMPORTANT SAFETY INSTRUCTIONS - SAVE THESE INSTRUCTIONS

The following precautions are used throughout this manual as indicated in their descriptions:



WARNING: To warn of hazards or unsafe practices that could result in severe personal injury or death.



CAUTION: To warn of unsafe practices that could result in minor or moderate personal injury.

FOR SAFETY: To identify actions that must be followed for safe operation of equipment.

The following information signals potentially dangerous conditions to the operator. Know when these conditions can exist. Locate all safety devices on the machine. Report machine damage or faulty operation immediately..



WARNING: Batteries emit hydrogen gas. Explosion or fire can result. Keep sparks and open flame away. Keep covers open when charging.



WARNING: Flammable materials can cause an explosion or fire. Do not use flammable materials in tank(s).



WARNING: Flammable materials or reactive metals can cause an explosion or fire. Do not pick up.



WARNING: Raised hopper may fall. Engage hopper support bar.



WARNING: Lift arm pinch point. Stay clear of hopper lift arms.



WARNING: Electrical Hazard

– Disconnect Battery Cables and Charger Plug Before Servicing Machine.

– Do Not Charge Batteries with Damaged Power Supply Cord. Do Not Modify Plug.

If the charger supply cord is damaged or broken, it must be replaced by the manufacturer or its service agent or a similarly qualified person in order to avoid a hazard.

WARNING: This machine contains chemicals known to the state of California to cause cancer, birth defects, or other reproductive harm.

This machine may be equipped with technology that automatically communicates over the cellular network. If this machine will be operated where cell phone use is restricted because of concerns related to equipment interference, please contact a Tennant representative for information on how to disable the cellular communication functionality.

FOR SAFETY:

1. Do not operate machine:
 - Unless trained and authorized.
 - Unless operator manual is read and understood.
 - Under the influence of alcohol or drugs.
 - While using a cell phone or other types of electronic devices.
 - Unless mentally and physically capable of following machine instructions.
 - With brake disabled.
 - Without filters in place or with clogged filters.
 - In dusty environments without the vacuum fan on.
 - If it is not in proper operating condition.
 - With pads or accessories not supplied or approved by Tennant. The use of other pads may impair safety.
 - In outdoor areas. This machine is for indoor use only.
 - In areas where flammable vapors/liquids or combustible dusts are present.
 - In areas that are too dark to safely see the controls or operate the machine unless operating / headlights are turned on.
 - In areas with possible falling objects unless equipped with overhead guard.
 - With the rear bumper door / step in the lowered position.
2. Before Starting Machine:
 - Check machine for fluid leaks.
 - Make sure all safety devices are in place and operate properly.
 - Check brakes and steering for proper operation.
 - Check parking brake pedal for proper operation.
 - Adjust seat and fasten seat belt (if equipped).

SAFETY

3. When using machine:
 - Use only as described in this manual.
 - Use brakes to stop machine.
 - Do not pick up burning or smoking debris, such as cigarettes, matches or hot ashes.
 - Go slowly on inclines and slippery surfaces.
 - Do not scrub on ramp inclines that exceed 11% grade or transport (GVWR) on ramp inclines that exceed 13% grade.
 - Reduce speed when turning.
 - Keep all parts of body inside operator station while machine is moving.
 - Always be aware of surroundings while operating machine.
 - Do not access the video / help screens while the machine is moving. (Pro-Panel)
 - Use care when reversing machine.
 - Move machine with care when hopper is raised.
 - Make sure adequate clearance is available before raising hopper.
 - Do not raise hopper when machine is on an incline.
 - Keep children and unauthorized persons away from machine.
 - Do not carry passengers on any part of the machine.
 - Always follow safety and traffic rules.
 - Report machine damage or faulty operation immediately.
 - Follow mixing, handling and disposal instructions on chemical containers.
 - Follow site safety guidelines concerning wet floors.
 - Do not leave machine unattended when filling solution tank with auto-fill feature.
 - Park machine on level surface when filling solution tank with auto-fill feature.
 4. Before leaving or servicing machine:
 - Stop on level surface.
 - Set parking brake.
 - Turn off machine and remove key.
 5. When servicing machine:
 - All work must be done with sufficient lighting and visibility.
 - Keep work area well ventilated.
 - Avoid moving parts. Do not wear loose clothing, jewelry and secure long hair.
 - Block machine tires before jacking machine up.
 - Jack machine up at designated locations only. Support machine with jack stands.
 - Use hoist or jack that will support the weight of the machine.
 - Do not push or tow the machine without an operator in the seat controlling the machine.
 - Do not push or tow the machine on inclines with the brake disabled.
- Use cardboard to locate leaking hydraulic fluid under pressure.
 - Do not power spray or hose off machine near electrical components.
 - Disconnect battery connections and charger cord before working on machine.
 - Do not use incompatible battery chargers as this may damage battery packs and potentially cause a fire.
 - Inspect charger cord regularly for damage.
 - Do not disconnect the off-board charger's DC cord from the machine receptacle when the charger is operating. Arcing may result. If the charger must be interrupted during

- charging, disconnect the AC power supply cord first.
- Avoid contact with battery acid.
 - Keep all metal objects off batteries.
 - Use a non-conductive battery removal device.
 - Use a hoist and adequate assistance when lifting batteries.
 - Battery installation must be done by trained personnel.
 - Follow site safety guidelines concerning battery removal.
 - All repairs must be performed by a trained service mechanic.
 - Do not modify the machine from its original design.
 - Use Tennant supplied or approved replacement parts.
 - Wear personal protective equipment as needed and where recommended in this manual.



For Safety: wear hearing protection.



For Safety: wear protective gloves.



For Safety: wear eye protection.



For Safety: wear protective dust mask.

6. When loading/unloading machine onto/off truck or trailer:
 - Drain tanks before loading machine.
 - Lower scrub head and squeegee before tying down machine.
 - Empty debris hopper before loading machine.
 - Stop on a level surface, set parking brake and leave the key in the ON position until all tie-down straps are secure.
 - Block machine tires.
 - Tie machine down to truck or trailer.
 - Use ramp, truck or trailer that will support the weight of the machine and operator.
 - Do not load/unload on ramp inclines that exceed 20% grade.
 - Use winch. Do not push the machine onto/off the truck or trailer unless the load height is 380 mm (15 in) or less from the ground.

SAFETY

The following safety labels are mounted on the machine in the locations indicated. Replace damaged / missing labels

WARNING LABEL - Flammable materials can cause explosion or fire. Do not use flammable materials in tank.



Located on solution tank cover, recovery tank cover and detergent tank (option).

WARNING LABEL - Flammable materials or reactive metals can cause explosion or fire. Do not pick up.



Located on electrical panel.

FOR SAFETY LABEL - Do not operate machine with the rear bumper door / step in the lowered position. Do not carry passengers on any part of the machine.



Located on rear bumper door / step.

FOR SAFETY LABEL - Authorized Service Mechanic Only.

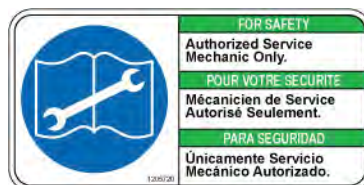

Located on circuit board cover and electrical panel.

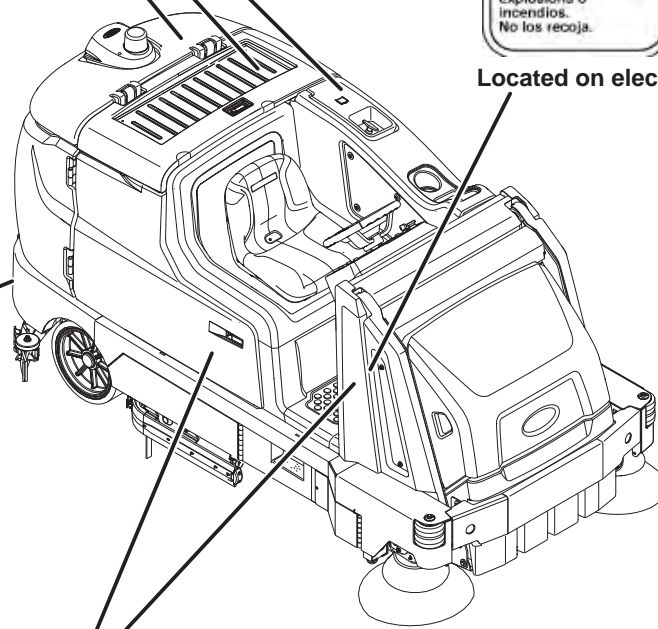

WARNING LABEL - Batteries emit hydrogen gas. Explosion or fire can result. Keep sparks and open flame away. Keep covers open when charging.



Located on bottom of battery compartment cover.

WARNING LABEL - Lift arm pinch point. Stay clear of lift arms.



Located on both lift arms.

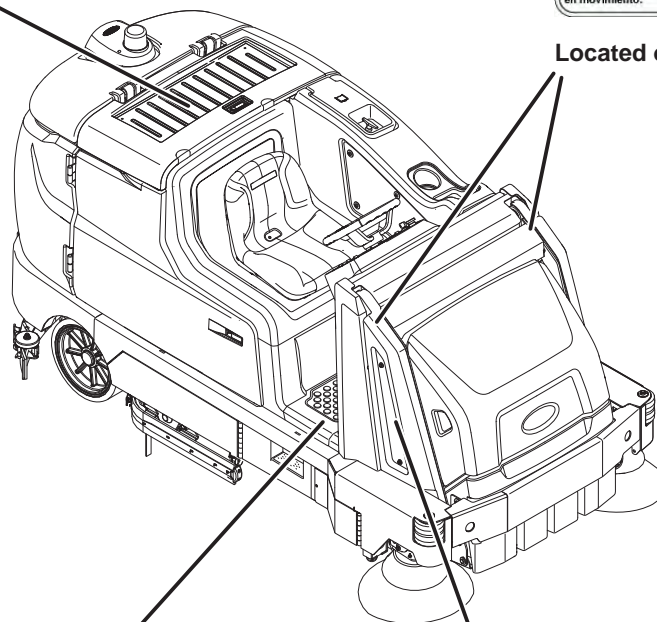

FOR SAFETY LABEL - Read manual before operating machine.



Located on electrical panel.

WARNING LABEL - Raised hopper may fall. Engage hopper support bar.

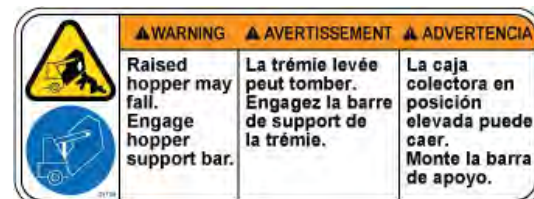

Located on hopper support bar.

MACHINE COMPONENTS

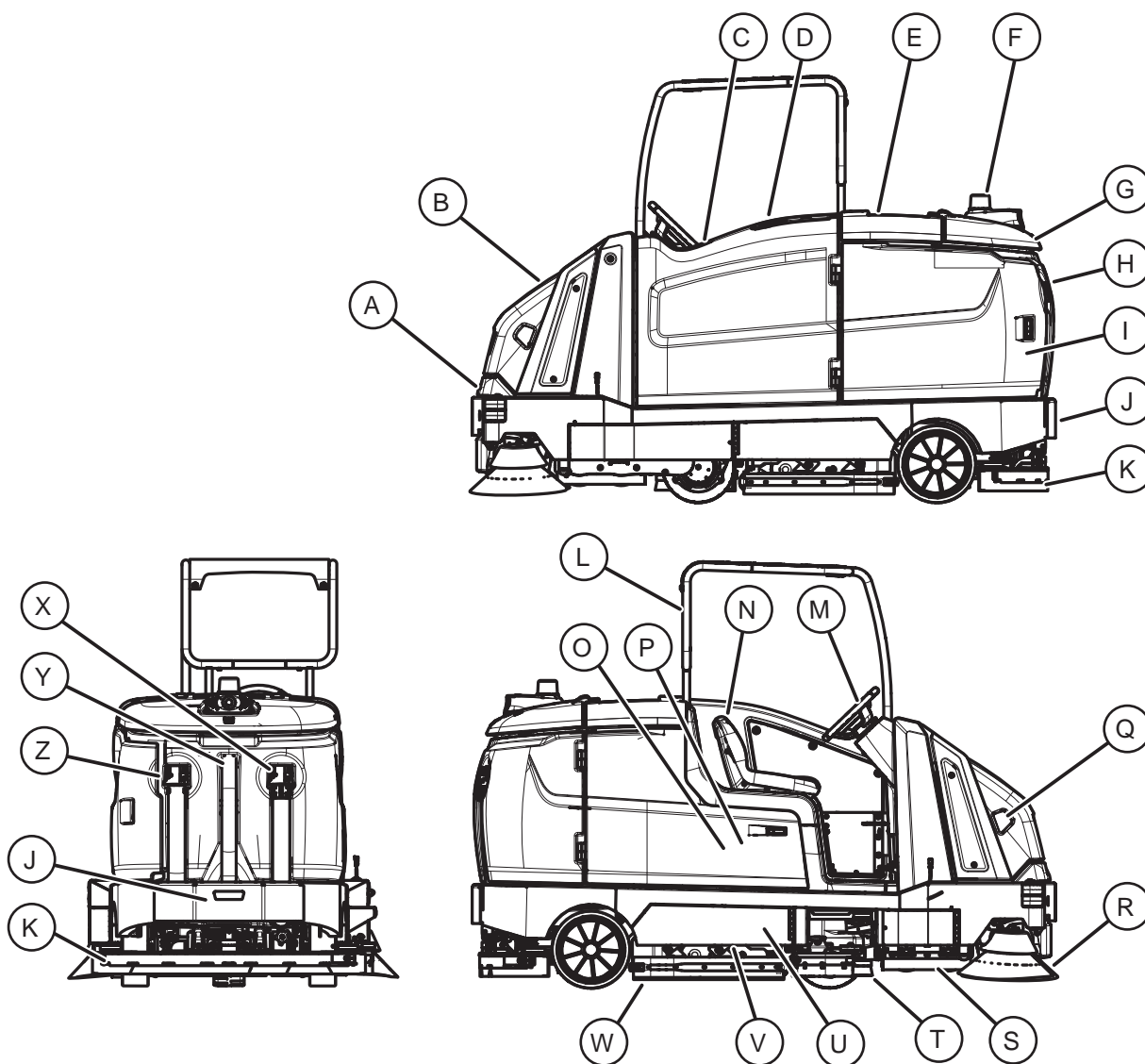

- A. Hopper
- B. Hopper cover
- C. Solution tank
- D. Solution tank cover
- E. Battery compartment cover
- F. Backup alarm / flashing light (Option)
- G. Recovery tank cover
- H. Recovery tank
- I. Left shroud
- J. Rear bumper door / step
- K. Rear squeegee
- L. Overhead guard (Option)
- M. Steering wheel
- N. Operator seat

- O. *ec-H2O* System Module compartment (Option) - located behind right shroud
- P. Right shroud
- Q. Hopper dust filter - located under hopper cover
- R. Sweeping side brushes
- S. Sweeping main brushes
- T. Scrubbing side brush (Option)
- U. Scrub head
- V. Scrubbing main brushes
- W. Side squeegees

CONTROLS AND INSTRUMENTS

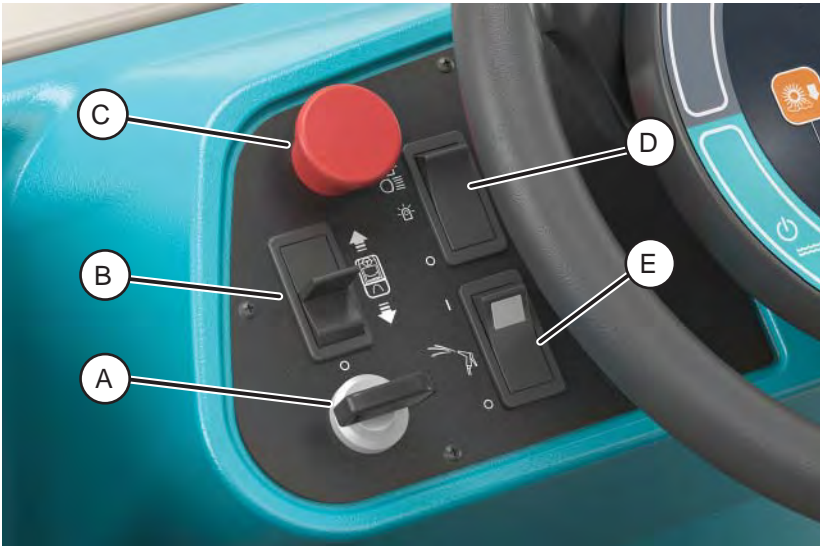

A

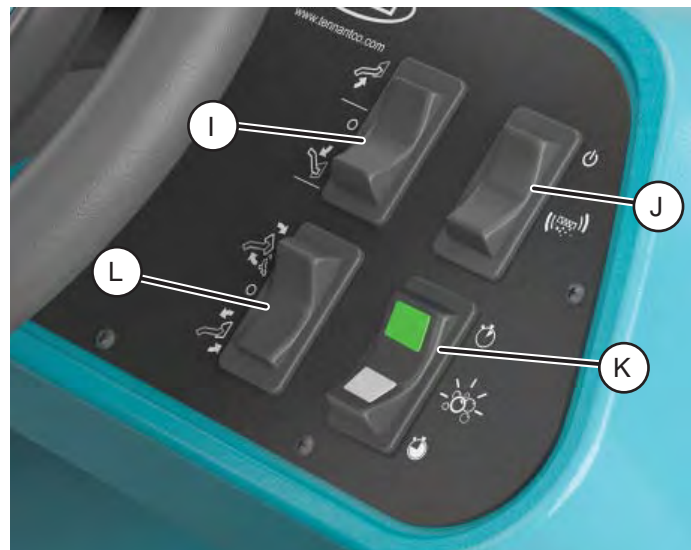
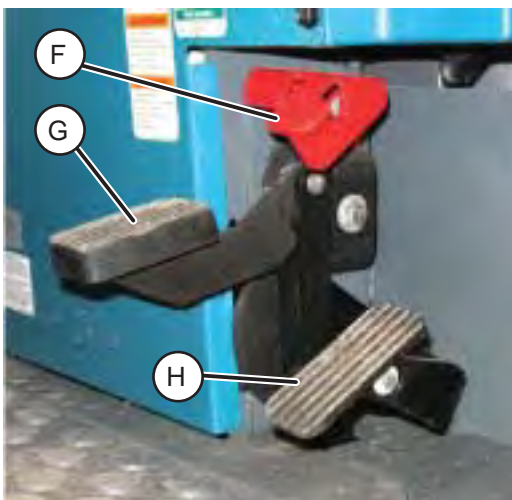

Standard Control Panel

- A. Key switch
- B. Directional switch
- C. Emergency shut-off button
- D. Operating lights / hazard lights switch (option)
- E. Spray nozzle switch (option)
- F. Parking brake pedal
- G. Brake pedal
- H. Propel pedal

Standard Control Panel Only

- I. Hopper raise / lower switch
- J. Filter shaker switch
- K. Severe environment switch (Option)
- L. Hopper rollout switch

STANDARD CONTROL PANEL



- | | |
|---|--|
| <ul style="list-style-type: none"> A. Horn B. Fault/Alert indicator light C. Contrast control button D. Battery discharge indicator E. Hour meter F. Configuration mode button G. Recovery tank full indicator H. LCD display I. Solution tank indicator J. Main scrub brush pressure button K. Main scrub brush pressure indicator lights L. 1-STEP button M. ec-H₂O / ES (Extended Scrub) button (Option) | <ul style="list-style-type: none"> N. Scrubbing buttons (Indicated in blue) O. Scrubbing main brush button P. Scrubbing vacuum fan / squeegee button Q. Scrubbing side brush button (Option) R. Sweeping buttons (Indicated in brown) S. Sweeping main brush button T. Sweeping vacuum fan button U. Sweeping side brush button V. Solution on / off buttons W. Solution decrease button (-) X. Solution flow indicator lights Y. Solution increase button (+) Z. USB port (Service only) |
|---|--|

PRO-PANEL CONTROLS

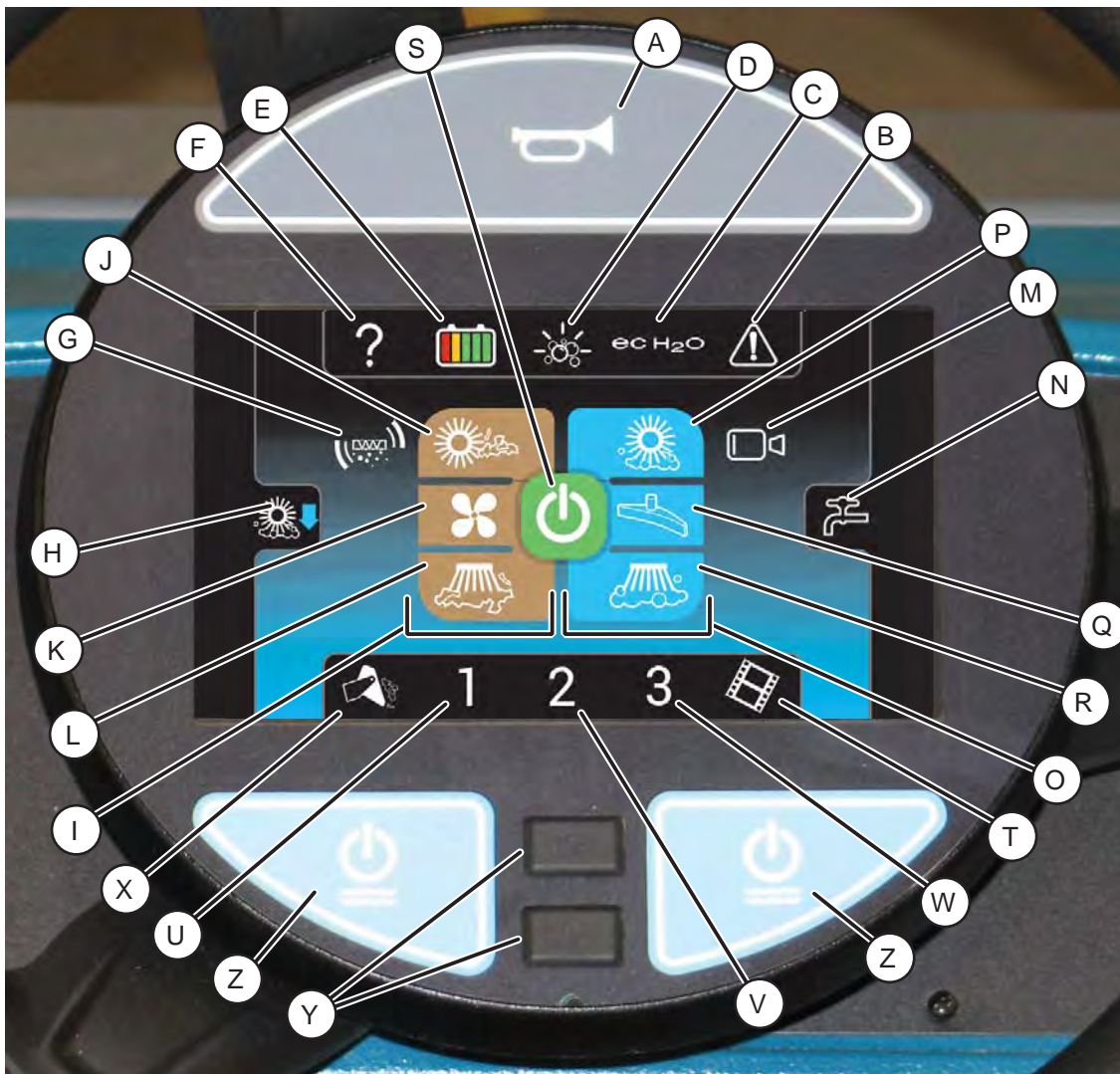

- | | |
|---|---|
| A. Horn | O. Scrubbing buttons (Indicated in blue) |
| B. Fault / alert indicator button | P. Scrubbing main brush button |
| C. ec-H ₂ O / ES (Extended Scrub) button | Q. Scrubbing vacuum fan / squeegee button |
| D. Severe environment button (Option) | R. Scrubbing side brush button (Option) |
| E. Machine status button | S. 1-STEP button |
| F. Help button | T. Video help |
| G. Filter shaker button | U. Zone control 1 button |
| H. Main scrub brush pressure access button | V. Zone control 2 button |
| I. Sweeping buttons (Indicated in brown) | W. Zone control 3 button |
| J. Sweeping main brush button | X. Hopper control button |
| K. Sweeping vacuum fan button | Y. USB port (Service only) |
| L. Sweeping side brush button | Z. Solution on / off buttons |
| M. Rearview camera button | |
| N. Solution control access button | |

SYMBOL DEFINITION

These symbols are used on the machine to identify controls, displays, and features.



Horn



Fault/Alert indicator



Recovery tank



Solution tank



Main scrubbing brush pressure



1-STEP



ES (Extended Scrub) (Option)



ec-H₂O (option)



Scrub mode



Sweeping side brush



Sweeping vacuum fan



Sweeping main brush



Scrubbing side brush



Scrubbing vacuum fan / squeegee



Scrubbing main brush



Solution decrease (-)



Solution increase (+)



Solution flow



Solution On / Off



On



Off



Emergency shut-off



Filter shaker



Operating lights / Hazard light



Hazard light



Spray nozzle (Option)



Severe environment (Option)



Circuit breaker



Jack point



Forward / Reverse

Standard Panel Symbols



Severe environment short detergent boost



Severe environment long detergent boost



Raise hopper



Battery charge



Lower hopper



Contrast control



Roll hopper out



Hour meter



Roll hopper in



Configuration control

Pro-Panel Symbols



Help



Hopper control access



Zone setting 1



Raise hopper



Zone setting 2



Lower hopper



Zone setting 3



Roll hopper out



Battery discharge indicator



Roll hopper in



Hopper control access



Alert / Fault



Hour meter



Checklist item unconfirmed



Login



Checklist item confirmed



Logout



Select

Pro-Panel Symbols



Supervisor settings



Rotate machine view



Supervisor menu



Camera settings



Start-up video



Control help



Video help



About



Video button



Backspace



Video list button



Rearview camera



Home (main operating screen)



Up arrow



Battery type



Down arrow



Disable login



Back arrow



Add / Edit profiles



Enable login



Operator



Calibrate touch



Supervisor



Checklist setup



Edit profile



Export all



Add profile



Export new



Delete profile



Export checklists



Copy profile



Enter

OPERATION OF CONTROLS - STANDARD PANEL

BATTERY DISCHARGE INDICATOR

The *battery discharge indicator* displays the charge level of the batteries while the machine is operating.



When the batteries are fully charged, all five bars are lit. Recharge the batteries when there is only one bar shown in the display. Do not allow the batteries to discharge below 20% (last bar).

NOTE: The reading on the battery discharge indicator is not accurate when the machine is first powered on. Operate the machine a few minutes before reading the charge level of the batteries.

HOUR METER

The *hour meter* records the hours the machine was operated. Use this information to determine machine service intervals.



RECOVERY TANK FULL INDICATOR

The *recovery tank full indicator* displays FULL when the recovery tank is full. All scrubbing functions will stop when the recovery tank is full. Empty the recovery tank when the indicator displays FULL.

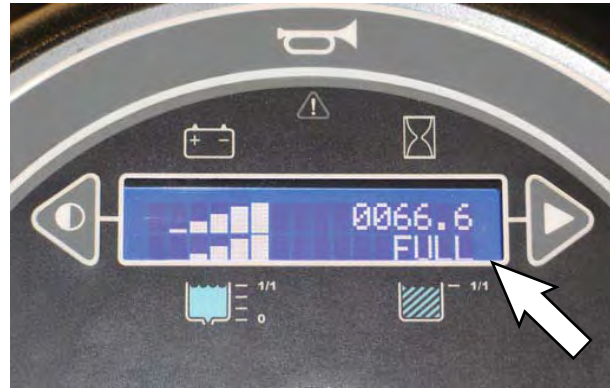

SOLUTION TANK INDICATOR

The *solution tank indicator* displays the amount of liquid in the solution tank. Refill the solution tank when there are no longer any bars shown in the display. The machine will stop scrubbing when the solution tank is empty.



OPERATION

CONTRAST CONTROL BUTTON

Use the *contrast control button* to darken / lighten the LCD display.



CONFIGURATION MODE BUTTON

The *configuration mode button* is for accessing the configuration and diagnostic modes. Only properly trained service personnel and TENNANT representatives should access these modes.



1-STEP BUTTON

Press the *1-STEP button* to activate all selected sweeping and scrubbing functions. Prior to the *1-STEP button* being pushed, the lights above all the selected sweeping / scrubbing functions will be on but the selected functions will be in the standby mode until the *1-STEP button* is pressed. Press the *1-STEP button* again when finished cleaning to stop all scrubbing and sweeping functions.

NOTE: The squeegee will remain down and the vacuum fan will remain on for a few seconds to pick up remaining water after the 1-STEP button is deactivated.

The indicator light above the button will illuminate when the *1-STEP button* is activated.

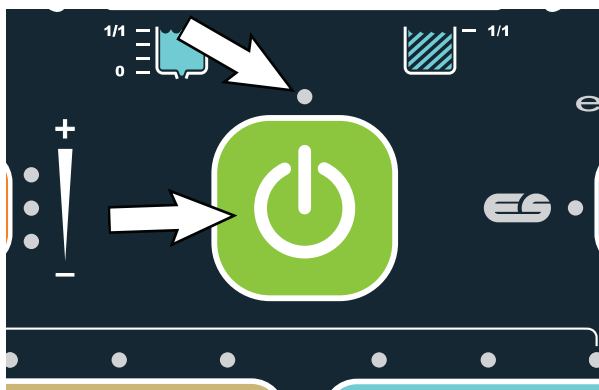

SWEEPING SIDE BRUSH BUTTON

Turn on the sweeping side brush: Press the *sweeping side brush button*. The indicator light will illuminate.

Turn off the sweeping side brush: Press the *sweeping side brush button*. The indicator light will turn off.

NOTE: The sweeping side brushes cannot operate independently from the main sweep brushes. The main sweep brushes also come on when the sweeping side brush button is pushed.

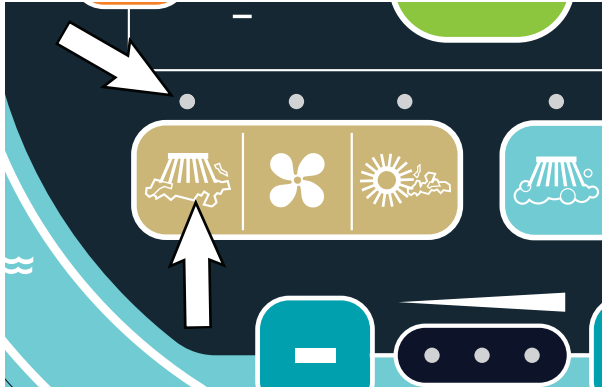
**SWEEPING VACUUM FAN BUTTON**

Turn on the sweeping vacuum fan: Press the *sweeping vacuum fan button*. The indicator light will illuminate.

Turn off the sweeping vacuum fan: Press the *sweeping vacuum fan button*. The indicator light will turn off.

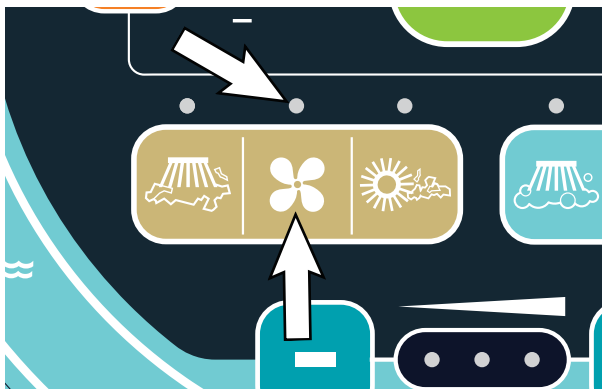
**SWEEPING MAIN BRUSH BUTTON**

Turn on the sweeping main brush: Press the *sweeping main brush button*. The indicator light will illuminate.

Turn off the sweeping main brush: Press the *sweeping main brush button*. The indicator light will turn off.

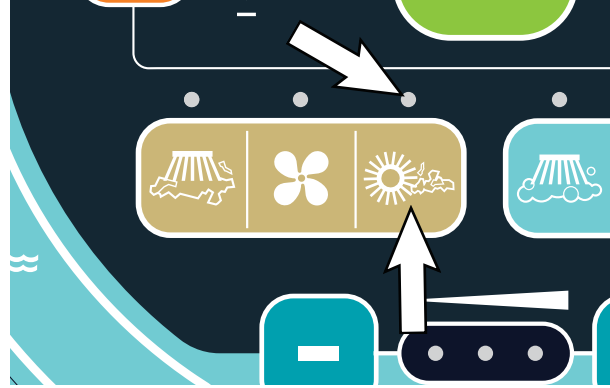
**SCRUBBING SIDE BRUSH BUTTON (OPTION)**

Turn on the scrubbing side brush: Press the *scrubbing side brush button*. The indicator light will illuminate.

Turn off the scrubbing side brush: Press the *scrubbing side brush button*. The indicator light will turn off.

NOTE: The scrubbing side brush cannot operate independently from the main scrub brushes. The main scrub brushes also come on when the scrubbing side brush button is pushed.



OPERATION

SCRUBBING VACUUM FAN / SQUEEGEE BUTTON

Lower squeegee and turn vacuum fan on: Press the *scrubbing vacuum fan / squeegee button*. The indicator light will illuminate.

Raise squeegee and turn vacuum fan off: Press the *scrubbing vacuum fan / squeegee button*. The indicator light will turn off.



SCRUBBING MAIN BRUSH BUTTON

Turn on the scrubbing main brush: Press the *scrubbing main brush button*. The indicator light will illuminate.

Turn off the scrubbing main brush: Press the *scrubbing main brush button*. The indicator light will turn off.



SOLUTION ON / OFF BUTTON

The solution flow is designed to stay on whenever the scrub brushes are on. It can be turned off for ten seconds with the *solution on / off button* to go around corners, etc. See also *SETTING THE SOLUTION FLOW* section.

Shut off the solution flow (for ten seconds) : Press the solution on / off button. All the solution flow indicators will turn off. (The solution flow will automatically restart at the end of the 10 second delay).

Turn on the solution flow: Press the *solution on / off button*. The solution indicators will turn back on and the solution flow will default to the last setting used.



SEVERE ENVIRONMENT SWITCH (OPTION)

The *severe environment switch* provides a detergent boost for areas with extraordinary dirt or soil buildup.

Press the top of *severe environment switch* to operate 30 seconds of detergent aided cleaning and the bottom to provide five minutes of detergent aided cleaning. The lights in the switch display which setting is activated.

NOTE: The *Severe Environment switch* can be configured to activate longer than five minutes. Contact Tennant service representative.

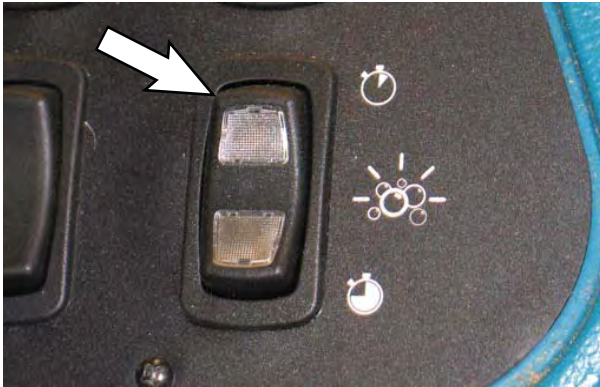

The *ec-H2O* scrubbing mode is temporarily disabled when the *severe environment switch* is activated. The *ec-H2O* mode automatically comes back on when *severe environment switch* is timed out / turned off.

The solution flow and brush pressure default to the highest / heaviest settings when the *severe environment switch* is activated but can be adjusted to lower / lighter settings. See **SETTING BRUSH PRESSURE** section and **SETTING SOLUTION FLOW** section.

FILTER SHAKER SWITCH

Press the *filter shaker switch*. The filter shaker will operate for 30 seconds.

The *filter shaker button* light will illuminate while the filter shaker is operating. Press the top of the *filter shaker switch* again if necessary to stop the filter shaker.

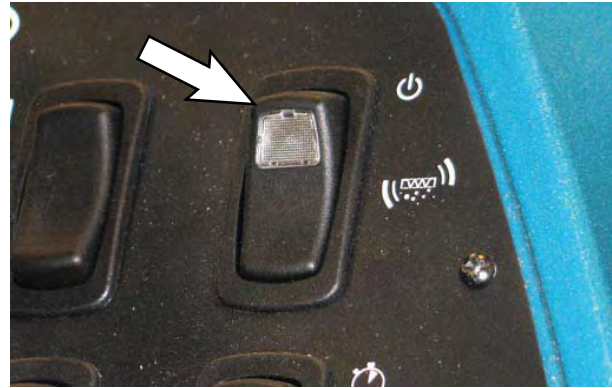

OPERATION OF CONTROLS - PRO-PANEL

PRO-ID LOGIN SCREEN

NOTE: The Pro-ID login screen only applies if the machine was set up with it. Predefined user accounts must be created within the Supervisor Mode.

Use the Pro-ID login screen to log into the machine.

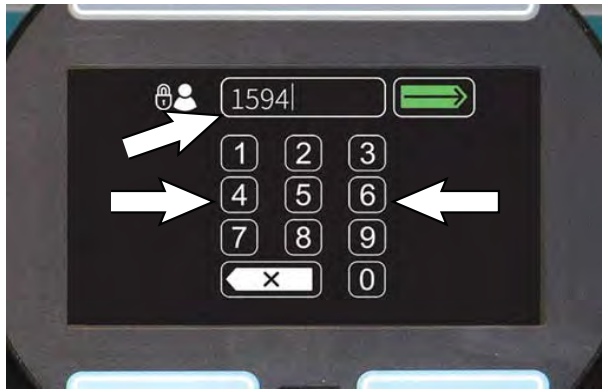

Use the keypad to enter the user login number into the display above the keypad.



Press the Enter button to log into the machine.



Press the backspace button if necessary to delete and reenter a number.

When the Pro-Panel is in the Supervisor Mode, a gear symbol will appear in the lower right part of the screen. When it is in the Operator Mode, a video symbol will appear.



MACHINE STATUS BUTTON

The *machine status button* allows access to four different machine status indicators. The default display shows the battery status when the machine is turned on. Any of the four indicators can be set as the default display until the machine is turned off.

Press the *machine status button* to access all four machine status buttons. All four machine status buttons appear in the display for several seconds until the default buttons reappear in the display.



The *battery discharge indicator* displays the charge level of the batteries while the machine is operating.

When the batteries are fully charged, all five bars are illuminated. Recharge the batteries when there is only one bar shown in the display. Do not allow the batteries to discharge below 20% (last bar).

NOTE: The reading on the battery discharge indicator is not accurate when the machine is first powered on. Operate the machine a few minutes before reading the charge level of the batteries.



The *hour meter* records the hours the machine was operated. Use this information to determine machine service intervals.



The *solution tank indicator* displays the amount of liquid in the solution tank. Refill the solution tank when there are no longer any bars shown in the display. The machine will stop scrubbing when the solution tank is empty.



The *recovery tank full indicator* displays FULL when the recovery tank is full. All scrubbing functions will stop when the recovery tank is full. Empty the recovery tank when the indicator displays FULL.

CHANGING THE DEFAULT BUTTON

Press the desired machine status button while all four machine status buttons appear in the display to change it to the new default button. The other three machine status buttons will disappear from the display and the newly selected machine status button will become the default until the machine is turned off. The battery status button will once again be the default when the machine is turned on.

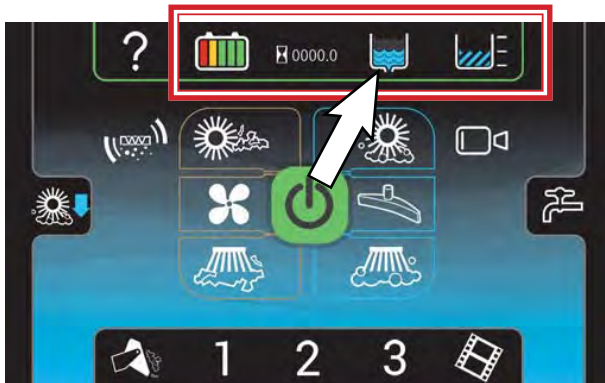

OPERATION

1-STEP BUTTON

Press the *1-STEP button* to activate all selected sweeping and scrubbing functions. Press the *1-STEP button* again when finished cleaning to stop all scrubbing and sweeping functions.

NOTE: The squeegee will remain down and the vacuum fan will remain on for a few seconds to pick up remaining water after the 1-STEP button is deactivated.

The *1-STEP button* and all selected scrubbing and sweeping function button will illuminate when the *1-STEP button* is pressed.

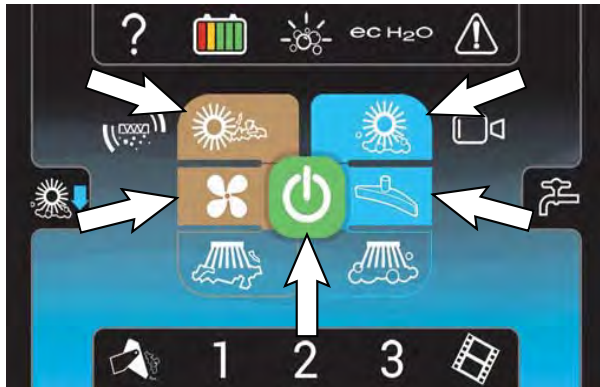

The edges of all selected sweeping and scrubbing buttons will be illuminated to show that they are in the standby mode prior to the *1-STEP button* being pressed. The selected buttons will become fully illuminated when the *1-Step button* is pressed.

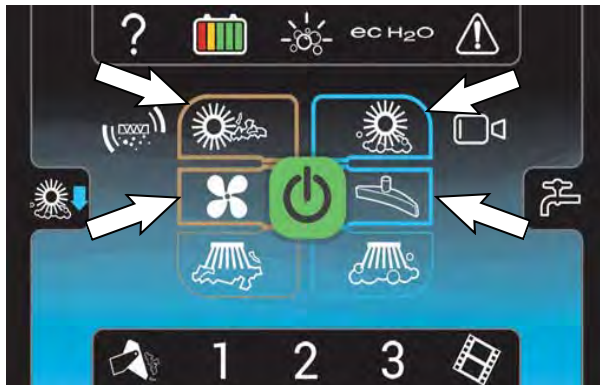

SWEEPING MAIN BRUSH BUTTON

Turn on the sweeping main brush: Press the *sweeping main brush button*. The button will illuminate.

Turn off the sweeping main brush: Press the *sweeping main brush button*. The button will turn off.



SWEEPING VACUUM FAN BUTTON

Turn on the sweeping vacuum fan: Press the *sweeping vacuum fan button*. The button will illuminate.

Turn off the sweeping vacuum fan: Press the *sweeping vacuum fan button*. The button will turn off.



SWEEPING SIDE BRUSH BUTTON

Turn on the sweeping side brush: Press the *sweeping side brush button*. The button will illuminate.

Turn off the sweeping side brush: Press the *sweeping side brush button*. The button will turn off.

**SCRUBBING VACUUM FAN / SQUEEGEE BUTTON**

Lower squeegee and turn vacuum fan on: Press the *scrubbing vacuum fan / squeegee button*. The button will illuminate.

Raise squeegee and turn vacuum fan off: Press the *vacuum fan / squeegee button*. The button will turn off.

**SCRUBBING MAIN BRUSH BUTTON**

Turn on the scrubbing main brush: Press the *scrubbing main brush button*. The button will illuminate.

Turn off the scrubbing main brush: Press the *scrubbing main brush button*. The button will turn off.

**SCRUBBING SIDE BRUSH BUTTON (OPTION)**

Turn on the scrubbing side brush: Press the *scrubbing side brush button*. The button will illuminate.

Turn off the scrubbing side brush: Press the *scrubbing side brush button*. The button will turn off.



OPERATION

SOLUTION ON / OFF BUTTON

The solution flow is designed to stay on whenever the scrub brushes are on. It can be turned off for ten seconds with the *solution on / off button* to go around corners, etc. See also *SETTING THE SOLUTION FLOW* section.

Shut off the solution flow (for ten seconds) : Press the solution on / off button. All the solution flow indicators will turn off. (The solution flow will automatically restart at the end of the 10 second delay).

Turn on the solution flow: Press the *solution on / off button*. The solution indicators will turn back on and the solution flow will default to the last setting used.



SEVERE ENVIRONMENT BUTTON (OPTION)

The *severe environment switch* provides a detergent boost for areas with extraordinary dirt or soil buildup.

Press the *severe environment button* to activate 30 seconds of detergent aided cleaning. The *severe environment button* will illuminate when activated and will go out when timed out / turned off. Press and hold the *severe environment button* several additional seconds to have the severe environment function activate five minutes of detergent aided cleaning.

NOTE: The Severe Environment switch can be configured to activate longer than five minutes. Contact Tennant service representative.



FILTER SHAKER BUTTON

Press the *filter shaker button*. The filter shaker will operate for 30 seconds.

The *filter shaker button* will illuminate while the filter shaker is operating. Press the *filter shaker button* again if necessary to stop the filter shaker.



The amount of time remaining for the severe environment scrub is displayed in the middle of the *1-STEP button*. It will turn off automatically when the timer expires or when pressed again.

The *ec-H2O* scrubbing mode is temporarily disabled when the *severe environment switch* is activated. The *ec-H2O* mode automatically comes back on when *severe environment switch* is timed out / turned off.

The solution flow and brush pressure default to the highest / heaviest settings when the *severe environment switch* is activated but can be adjusted to lower / lighter settings. See *SETTING BRUSH PRESSURE* section and *SETTING SOLUTION FLOW* section.

ZONE CONTROL BUTTONS

Machines equipped with the Pro-Panel can be pre-programmed for up to three preset scrubbing / sweeping settings for different floor cleaning applications. These must be set up ahead of time using the supervisor mode. See *PROGRAMMING THE ZONE CONTROL BUTTONS* section.



Press the required zone control button. The selected preset button will illuminate and the name of the zone appears above the button. The *solution flow indicator bar* / adjustment buttons and *brush pressure indicator bar* / adjustment buttons briefly appear in the display to show the settings for the selected zone.

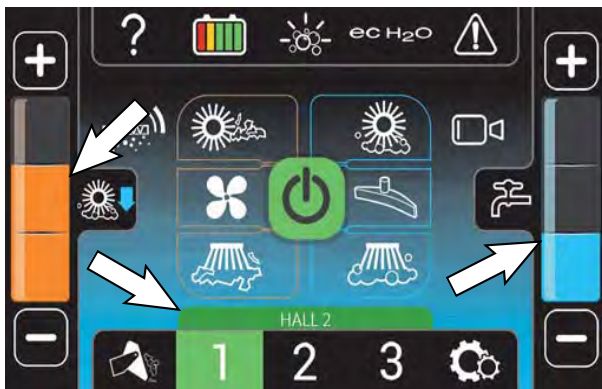

REARVIEW CAMERA BUTTON

Press the *rearview camera button* to check cleaning performance. The rearview camera screen will appear in the control panel display for a short amount of time. The main operating screen returns to the control panel after the rearview camera times out. Touch anywhere on the control panel display to turn off the rearview camera and return to the main operating screen.

FOR SAFETY: When using machine, always be aware of your surroundings.



The camera automatically comes on when the *directional switch* is placed in the reverse position and remains on the entire time the machine is in reverse.

The rearview camera is located on the recovery tank, above where the vacuum hose is attached to the recovery tank.

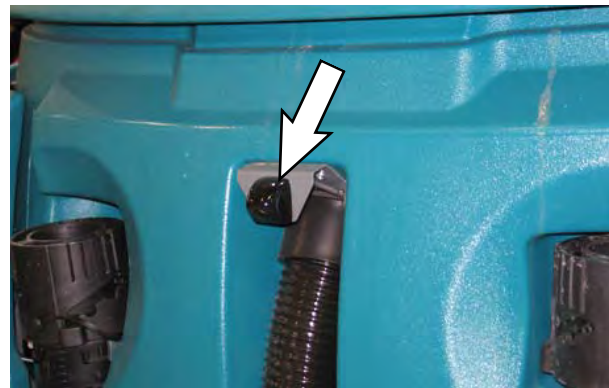

OPERATION

HELP BUTTON

FOR SAFETY: When using machine, do not access the video / help screens while the machine is moving. (Pro-Panel)

Press the *help button* to access the help screen.



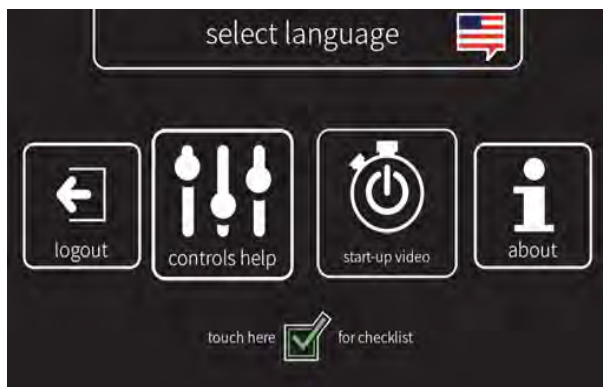

Press the applicable button for the help topic needed.





 Press the *select language button* to go to the language screen.

 Press the *login / logout button* to log in / log out of the machine operating system.

 Press the *controls help button* to access the controls help screen.

 Press the *start-up video button* to watch the start-up video.

 Press the *about button* to access machine operating system information.

 Press the *Pre-Operation Checklist button* to access the Pre-Operation Checklist.

Press the select language button. Select an applicable language from the list to change the machine operating system language. A flag designating the country language selected will appear at the top of the screen.



 Press the *down arrow button* to scroll down through the language list.

 Press the *up arrow button* to scroll up through the language list.

 Press the *back arrow button* to return to the previous screen.

 Press the *Pre-Operation Checklist button* to access the Pre-Operation Checklist.

Press the *control help button* to access information about the Pro-Panel controls.

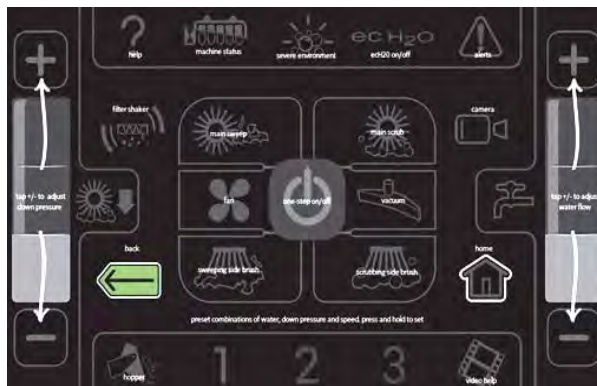





 Press the *back arrow button* to return to the main help screen.

 Press the *home button* to return to the main operating screen.

Press the *about button* to access information about the operating system software.



-  Press the *down arrow button* to scroll down through the language list.
-  Press the *up arrow button* to scroll up through the language list.
-  Press the *home button* to return to the main operating screen.
-  Press the *back arrow button* to return to the previous screen.
-  Press the *forward arrow button* to access machine information from the list.

OPERATION

VIDEO HELP BUTTON

FOR SAFETY: When using machine, do not access the video / help screens while the machine is moving. (Pro-Panel)

*NOTE: Stop machine before accessing video help screen / videos. **Do Not** access the video help screen / videos while the machine is moving.*

Press the *video button* to access the video help screen.

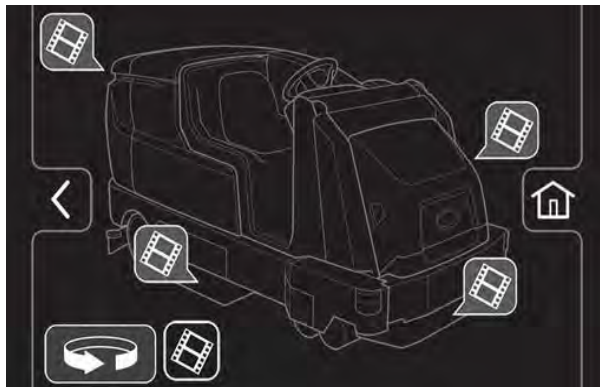

Press the applicable *video button* to view the help video for a particular machine component.



Press the *rotate machine button* to access video help buttons located on the front, back, or other side of the machine.



Press the *home button* to return to the main operating screen.



Press the *back arrow button* to return to the previous screen.



Press the *video list button* to access a text list of all help videos.

Select an applicable video from the list to view the video if the *video list button* was pressed to access the video list.

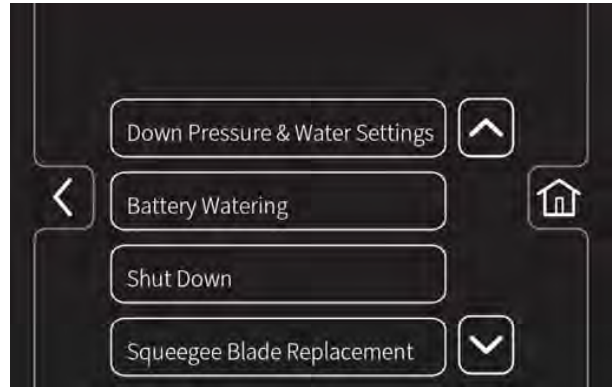

Press the *down arrow button* to scroll down through the list.



Press the *up arrow button* to scroll up through the list.



Press the *home button* to return to the main operating screen.



Press the *back arrow button* to return to the previous screen.

COMPLETING THE PRO-CHECK PRE-OPERATION CHECKLIST

Machines equipped with the Pro-Panel controls can be pre-programmed with the Pro-Check Pre-Operation Checklist the operator must complete before operating the machine.



Press the *down arrow button* to scroll down through checklist.



Press the *up arrow button* to scroll up through checklist.



Press the *complete (check mark) button* to confirm the checklist item was checked. Press the *problem found (X) button* if a problem is found when checklist item is checked.



Press the *video help button* to view the video related to a particular checklist item.



Press the *enter button* when ready to start using the machine after completing the checklist.



Press the *help button* to access the Pro-Check Pre-Operation Checklist help screen.



Press the *back button* to return to the Pre-Operation Checklist.

The operator is not allowed to access the main operating screen / use machine until the Pro-Check Pre-Operation Checklist is completed. Press the *back arrow button* to return to the checklist screen.

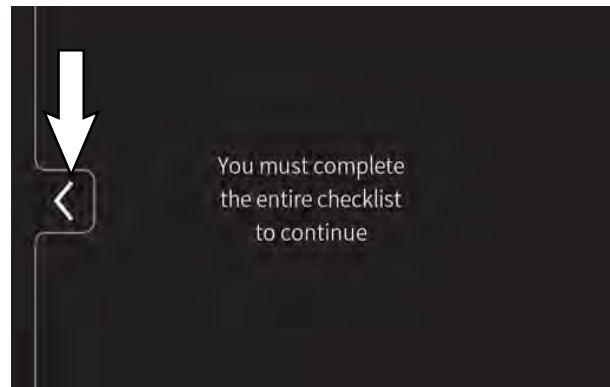

OPERATION

OPERATION OF CONTROLS - ALL MACHINES

EMERGENCY SHUT-OFF BUTTON

The *emergency shut-off button* immediately stops the machine.

NOTE: Parking brake must be applied if machine is stopped on a grade.

Stop machine power: Push the *emergency shut-off button*.

Restart machine power: Turn the *emergency shut-off button* to the right to release the button. Turn the key switch to the OFF position, then turn the key fully clockwise and release it to the ON position.



Only use this button in the event of an emergency. It is not intended for routine machine shutdown.

DIRECTIONAL SWITCH

Use the *directional switch* to select either the forward or reverse direction. Press the *propel pedal* to move the machine.



NOTE: An audible alarm will sound when the directional switch is placed into reverse.

NOTE: Machines equipped with the optional flashing light / backup alarm only: The optional backup light and alarm will function only when the machine is moving in reverse.

NOTE: The rearview camera automatically comes on when the directional switch is placed into reverse on all machines equipped with the Pro-Panel.

OPERATING / HAZARD LIGHT SWITCH (OPTION)

Operating and Hazard Lights On: Press the top of the *operating / hazard light switch*.

Hazard Lights On: Press the *operating / hazard light switch* to the middle position.

All Lights Off: Press the bottom of the *operating / hazard light switch*.

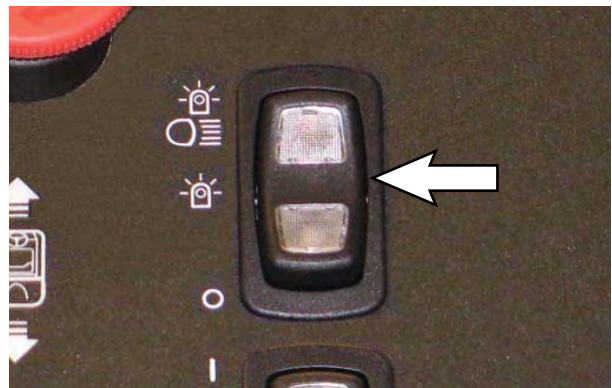

PROPEL PEDAL

Press the *propel pedal* to move the machine.

**OPERATOR SEAT**

The *front-to-back adjustment lever* adjusts the seat position.

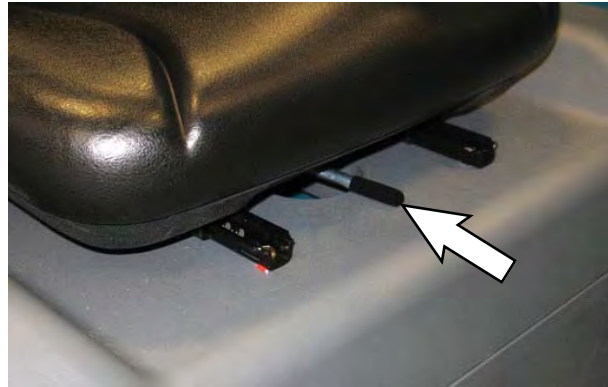
**BRAKE PEDAL**

Press the *brake pedal* to stop the machine.

**SEAT BELTS (Deluxe Seat Option Only)**

FOR SAFETY: Before starting machine, adjust seat and fasten seat belt.

**PARKING BRAKE PEDAL**

Position toe onto the *parking brake pedal* and press both the *brake pedal* and *parking brake pedal* down to engage the parking brake. Press just the *brake pedal* to release the parking brake.



OPERATION

REAR BUMPER DOOR / STEP

The *rear bumper door / step* provides easier access to the top of the machine for cleaning the recovery tank and can be lowered to access the lower rear areas of the machine near the rear squeegee and the squeegee vacuum hose.

The *rear bumper door / step* must also be lowered to completely empty both the solution tank and the recovery tank.

To open the *rear bumper door / step*, lift the *rear bumper door / step* with the handle and place into the lowered position.

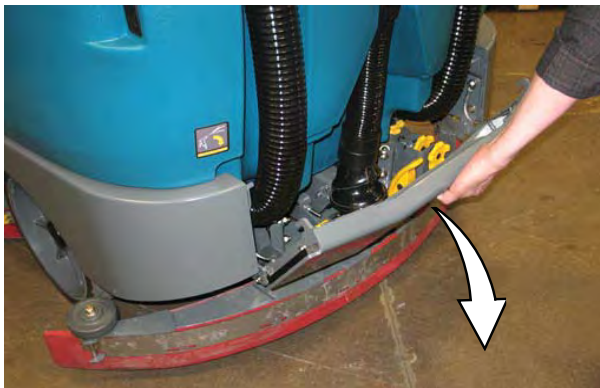
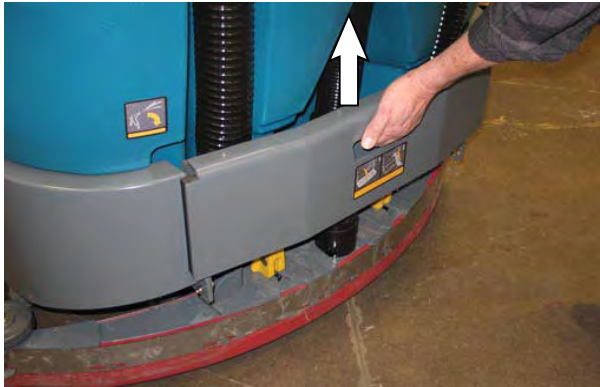

NOTE: Step only in the tread area of the rear bumper door / step. **Do Not** step into the two marked indented non-tread areas on each side of the rear bumper door / step.



The *rear bumper door / step* must also be lowered to completely empty both the solution tank and the recovery tank.



FOR SAFETY: Do not operate machine with the rear bumper door / step in the lowered position. Do not carry passengers on any part of the machine.



HOW THE MACHINE WORKS



The *1-STEP* button makes it possible to immediately begin scrubbing and / or sweeping by operating all the scrubbing and sweeping functions.

When the sweep mode is functioning the side brushes sweep debris into the path of the main sweeping brush. The main brush sweeps debris from the floor and into the hopper. The vacuum system pulls dust through the filtration system.

When the scrub mode is functioning water and detergent flow to the floor through a solution valve to the scrub brushes. The brushes scrub the floor. As the machine moves forward the squeegees wipe the dirty solution off the floor and the vacuum system draws the dirty solution into the recovery tank.

When in the optional ES (Extended Scrub) mode, the dirty solution in the recovery tank is filtered through the ES system and returned to the solution tank for reuse. Detergent is then injected into the returned solution to revitalize the cleaning capability of the solution.

When in the optional *ec-H2O* (electrically converted water) mode, normal water passes through a module where it is oxygenated and charged with an electric current. The electrically converted water changes into a blended acidic and alkaline solution forming a neutral pH cleaner. The converted water attacks the dirt, breaks it into smaller particles, and pulls it off the floor surface allowing the machine to easily scrub away the suspended soil. The converted water then returns to normal water in the recovery tank. The *ec-H2O* system can be used while double scrubbing.

BRUSH AND PAD INFORMATION

For best results, use the appropriate brush or pad for the cleaning application. Listed below are brushes and pads and the applications for which each is best suited.

NOTE: The amount and type of soilage play an important role in determining the type of brush or pad to use. Contact a Tennant representative for specific recommendations.

Nylon brush (Cylindrical and Disk)* - Softer nylon bristles are recommended for scrubbing coated floors. Cleans without scuffing.

Heavy Duty Polypropylene brush (Disk) - Heavy duty polypropylene bristles provide a more aggressive cleaning performance and can more easily lift compacted dirt, debris, and sand while offering excellent scrubbing performance.

Polypropylene brush (Cylindrical and Disk)* - General purpose polypropylene bristles lift lightly compacted dirt without scuffing high-gloss coated floors.

Super AB brush (Cylindrical and Disk)* - Nylon fiber with an abrasive grit to remove stains and compacted dirt. Aggressive action on any surface. Performs well on buildup, grease, or tire marks.

** This brush is also available for the side brush.*

Polypropylene Sand Wedge Main Brush – For sweeping heavy accumulations of sand and other small particulates.

Stripping pad (Brown) - For stripping of floor finish to prepare the floor for recoating.

Scrubbing pad (Blue) – For medium to heavy duty scrubbing. Removes dirt, spills, and scuffs.

Buffing pad (Red) - For light duty scrubbing without removing floor finish.

Polishing pad (White) - For maintaining highly polished or burnished floors.

Polypropylene Side Brush – For general sweeping of light to medium debris.

Grip pad driver - The grip-face backing allows pads to be fully used and holds pads in place without penetrating the pad. The spring-activated centering device works with all Tennant pads and allows for fast, easy pad replacement.

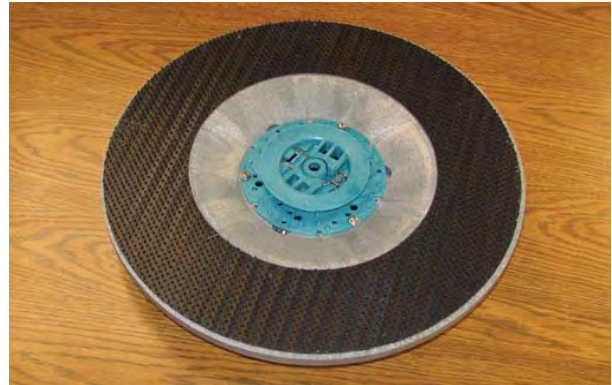

Tufted pad driver - Standard pad driver has short bristles, or “tufts,” on the back to hold the pad in place. This driver works with all Tennant pads except the black high productivity pad.

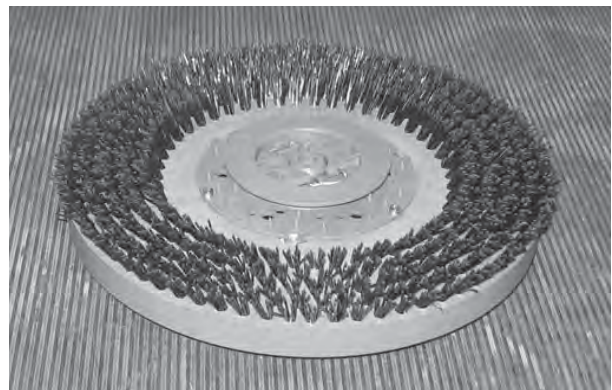

WHILE OPERATING THE MACHINE

Pick up oversized debris before scrubbing / sweeping. Pick up wire, string, twine, large pieces of wood, or any other debris that could become wrapped around or tangled in the brushes.

Drive in a straight a path as possible. Avoid bumping into posts or scraping the sides of the machine. Overlap the scrub / sweep paths by several centimeters (a few inches).

Avoid turning the steering wheel too sharply when the machine is in motion. The machine is very responsive to the movement of the steering wheel. Avoid sudden turns, except in emergencies.

Adjust the machine speed, brush pressure, and solution flow as required when scrubbing. Use the lowest brush pressure and solution flow settings for best performance.

If poor cleaning performance is observed, stop cleaning and refer to MACHINE TROUBLESHOOTING in this manual.

Perform the Daily Maintenance Procedures after each use (see MACHINE MAINTENANCE in this manual).

Drive the machine slowly on inclines. Use the brake pedal to control machine speed on descending inclines. Scrub with the machine up inclines rather than down inclines.

FOR SAFETY: When using machine, go slowly on inclines and slippery surfaces.

Do not operate machine in areas where the ambient temperature is above 43° C (110° F). Do not operate scrubbing functions in areas where the ambient temperature is below freezing 0° C (32° F).

FOR SAFETY: When using machine, do not scrub on ramp inclines that exceed 11% grade or transport (GVWR) on ramp inclines that exceed 13% grade.

OPERATION

PRE-OPERATION CHECKLIST

Perform the following steps before operating the machine:

- Check for fluid leaks.
- Check the hydraulic fluid level.
- Check the condition of the hopper dust filter and seals.
- Clean the hopper and the debris screen.
- Check left side squeegee for wear and damage.
- Check main brushes for wear and damage. Remove wire, string, or twine wrapped around the main scrub brushes.
- Machines equipped with cylindrical brushes: Confirm the debris trough is empty and clean.
- Machines equipped with side brush option: Check for wire, string, or twine wrapped around the scrub brush.
- Machines equipped with scrubbing side brush option: Check squeegee for wear and damage.
- Check the rear squeegees for wear and damage.
- Check the recovery tank cover seal for wear or damage.
- Confirm the vacuum fan inlet filter is clean.
- Machines equipped with ES option: Drain and clean the solution tank, float sensor, and ES filter
- Machines equipped with ES option: Ensure ES filter at bottom of recovery tank is clean.
- Check the right side squeegee for wear and damage.
- Check the solution tank cover seal for wear or damage.
- ec-H2O* Scrubbing: Confirm all conventional cleaning agents/restorers are drained and rinsed from the solution tank.
- ec-H2O* Scrubbing: Confirm the solution tank is filled with clear cool water only.
- Check the horn, headlights, taillights, safety lights, and backup alarm (if equipped).
- Check the brakes and steering for proper operation.
- Check parking brake pedal for proper operation.
- Check the tires for damage.
- Check maintenance records to determine maintenance requirements.

STARTING THE MACHINE

FOR SAFETY: Before starting machine, adjust seat and fasten seat belt (if equipped).

1. Sit in the operators seat.
2. Turn the *key switch* to the ON position.

NOTE: If the machine was just turned off, wait at least five seconds before restarting so that the software can fully reboot.



3. Turn on lights (if equipped).
4. Place the *directional switch* into the direction needed to travel.
5. Press the *propel pedal* to move the machine.

NOTE: The machine will not travel unless the operator is sitting in the operator seat.

FILLING THE DETERGENT TANK (OPTION)

FOR SAFETY: Before leaving or servicing machine, stop on level surface, turn off machine, set parking brake, and remove key.

1. Open the left shroud to access the detergent tank.
2. Remove the cap from the detergent tank.



3. Pour detergent into the detergent tank.



WARNING: Flammable materials can cause an explosion or fire. Do not use flammable materials in tank(s).

ATTENTION: For Conventional Scrubbing, only use recommended cleaning detergents. Machine damage due to improper detergent usage will void the manufacturer warranty.



4. Reinstall the cap onto the detergent tank.

FILLING THE SOLUTION TANK

CONVENTIONAL SCRUBBING MODE

FOR SAFETY: Before leaving or servicing machine, stop on level surface, turn off machine, set parking brake, and remove key.

1. Twist the handle and lift the solution tank cover open.



2. Partially fill solution tank with water (not to exceed 60°C / 140°F). Pour the required amount of detergent into the solution tank. Continue filling the solution tank with water until the level is approximately 25 mm (1 in) below the opening.



WARNING: Flammable materials can cause an explosion or fire. Do not use flammable materials in tank(s).

ATTENTION: For Conventional Scrubbing, only use recommended cleaning detergents. Machine damage due to improper detergent usage will void the manufacturer warranty.

NOTE: Pour a recommended foam control solution into the recovery tank if excessive foam appears. For specific detergent recommendations, contact a Tennant representative.

3. Close the solution tank cover.

ec-H2O SCRUBBING (ec-H2O MODE)

FOR SAFETY: Before leaving or servicing machine, stop on level surface, turn off machine, set parking brake, and remove key.

1. Twist the handle and lift the solution tank cover open.



2. Fill the solution tank with only clean COOL WATER (less than 21°C / 70°F). DO NOT use hot water or add any conventional floor cleaning detergents or an ec-H2O system failure may result. Fill the solution tank with water until the level is approximately 25 mm (1 in) below the opening.



WARNING: Flammable materials can cause an explosion or fire. Do not use flammable materials in tank(s).

NOTE: Do not use the ec-H2O system when there are conventional cleaning detergents in the solution tank. Drain, rinse, and refill the solution tank with clear cool water before operating the ec-H2O system. Conventional cleaning detergents may cause an ec-H2O system failure.

3. Close the solution tank cover.

ES (EXTENDED SCRUB) MODE - MANUAL TANK FILL

FOR SAFETY: Before leaving or servicing machine, stop on level surface, turn off machine, set parking brake, and remove key.

1. Twist the handle and lift the solution tank cover open.



2. Fill solution tank with water (not to exceed 60°C / 140°F). Fill the solution tank with water until the level is approximately 25 mm (1 in) below the opening.
3. Close the solution tank cover.
4. Fill the recovery tank to just above the top of the ES filter with water (not to exceed 60°C / 140°F).

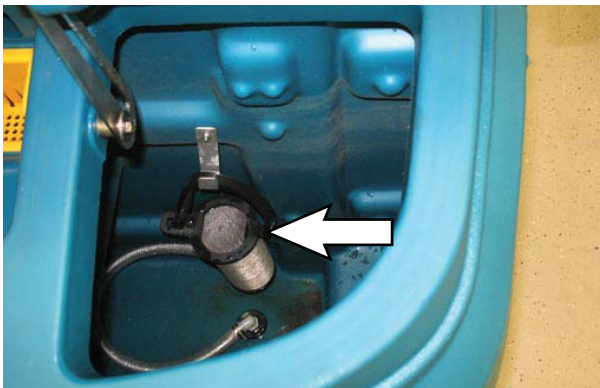

5. Close the recovery tank cover.
6. Fill the detergent tank with detergent.



WARNING: Flammable materials can cause an explosion or fire. Do not use flammable materials in tank(s).

AUTO-FILL (OPTION)

FOR SAFETY: Before leaving or servicing machine, stop on level surface, set parking brake, and turn off machine.

1. Lower the rear bumper door / step.
2. Connect the hose from the water source (not to exceed 60°C / 140°F) to the auto-fill connection.



3. Turn the Key switch to the ON position and turn on the water source. The auto-fill automatically fills the tank(s) to the proper level(s).



WARNING: Flammable materials can cause an explosion or fire. Do not use flammable materials in tank(s).

ATTENTION: For ES Scrubbing, only use recommended low-foaming cleaning detergents. Machine damage due to the use of improper detergent will void the manufacturer's warranty.

4. Raise the rear bumper door / step.

ec-H2O BUTTON (OPTION)

The *ec-H2O button* enables the *ec-H2O* system to come on when the *1-STEP button* and scrubbing functions are activated. Press the *ec-H2O button* to turn on the *ec-H2O* system.

ec-H2O machines equipped with *severe environment switch* only: Machines equipped with the *severe environment switch* default to the *ec-H2O* setting upon start up.

Machines equipped with standard control panel: The light between the *ec-H2O* logo and *ec-H2O button* will come on when activated.

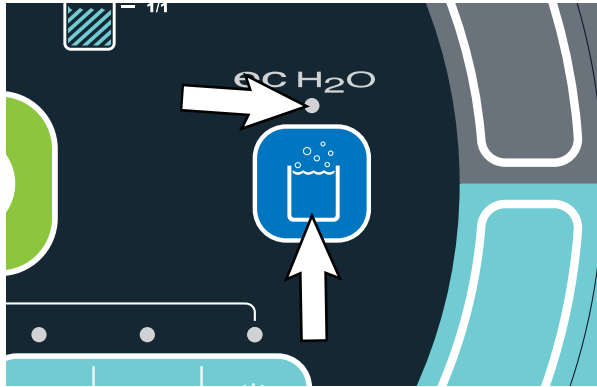

Standard Panel

A flashing red light located on the bottom portion of the LED (light-emitting diode) light directly above the *ec-H2O* button indicates when the *ec-H2O* system needs to be flushed. See *ec-H2O MODULE FLUSH PROCEDURE* in the *MAINTENANCE* section.



Standard Panel

Machines equipped with Pro-Panel controls:

The background will change from black to the multicolored background, the slash disappears from the *ec-H2O button*, and the button is illuminated when the *ec-H2O button* is pushed to indicate it is active.

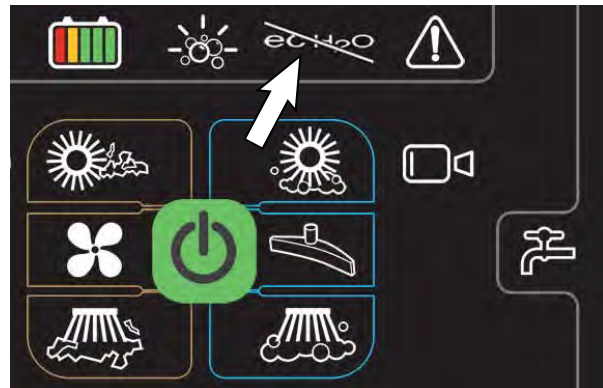

Pro-Panel

The *ec-H2O* button will turn red, the fault / alert indicator button will flash, and an *ec-H2O* error message will appear in the display when there is an *ec-H2O* error.

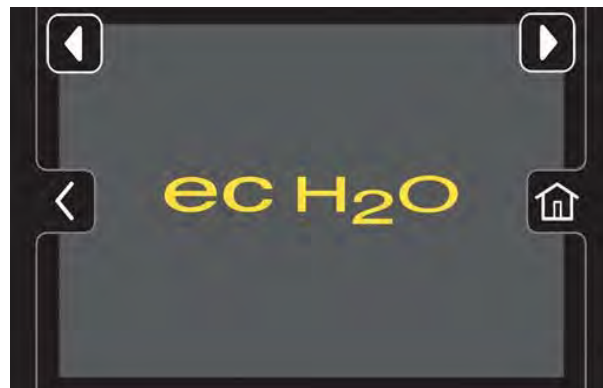

ES (EXTENDED SCRUB) BUTTON (OPTION)

The *ES button* enables the ES system to come on when the *1-STEP button* is activated.

Machines equipped with standard control panel: The light between the ES logo and *ES button* will come on when the *ES button* is pushed.

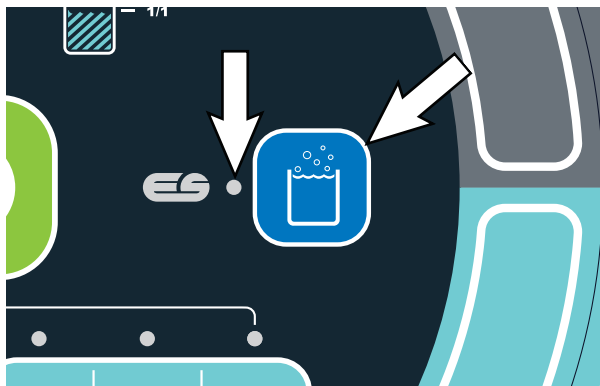

Standard Panel

Machines equipped with Pro-Panel controls: The slash disappears from the *ES button* and the button is illuminated when the *ES button* is pushed to indicate it is active.

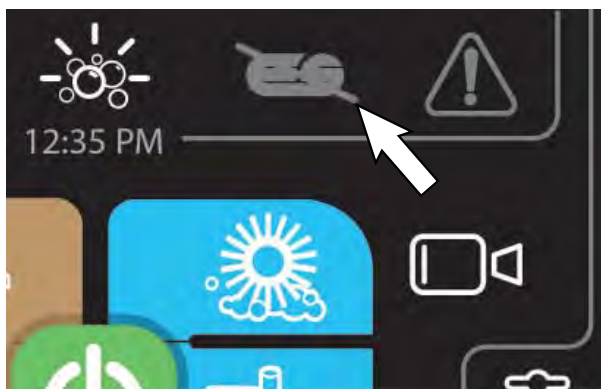

Pro-Panel

SCRUB BRUSH PRESSURE

Under normal cleaning conditions, the brush pressure should be set to the lowest setting. Under heavy grime conditions, the brush pressure can be set to a higher setting. Travel speed and floor conditions will affect cleaning performance. If brushes are worn, it may be necessary to increase the brush pressure. The machine will default to the last setting used when it is powered on or off.

SETTING THE BRUSH PRESSURE - STANDARD PANEL

With the *1-STEP* button activated, press the *brush pressure* button to both raise or lower the brush pressure settings. The brush pressure indicator lights display the current brush pressure setting.



SETTING THE BRUSH PRESSURE - PRO-PANEL

Press the *brush pressure* button to access the *brush pressure increase (+)* button, the *brush pressure decrease (-)* button, and the *brush pressure indicator bar*.



Use the *brush pressure increase (+)* button and the *brush pressure decrease (-)* button to change the brush pressure. The *brush pressure indicator bar* displays the current brush pressure setting.

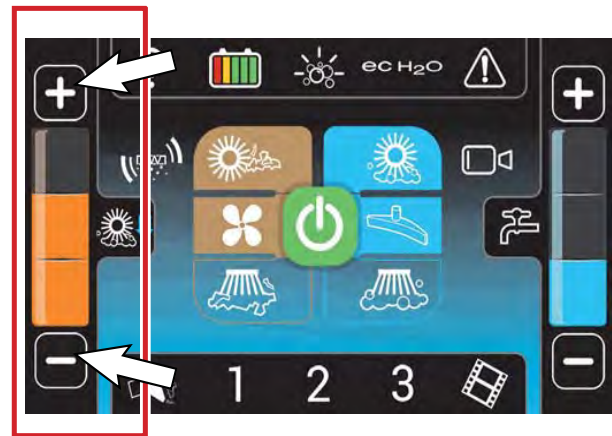

SOLUTION FLOW

Travel speed and floor conditions will affect scrubbing performance. Under normal soilage conditions the solution flow level should be set to the lowest setting. Under heavy grime conditions, the solution flow level should be set to the higher settings. The machine will default to the last setting used when the machine is powered on or off.

SETTING THE SOLUTION FLOW - STANDARD PANEL

With the *1-STEP* button activated, press either *solution increase (+)* button or *solution decrease (-)* button to set the solution flow level. The solution flow indicator lights display the current solution flow setting.

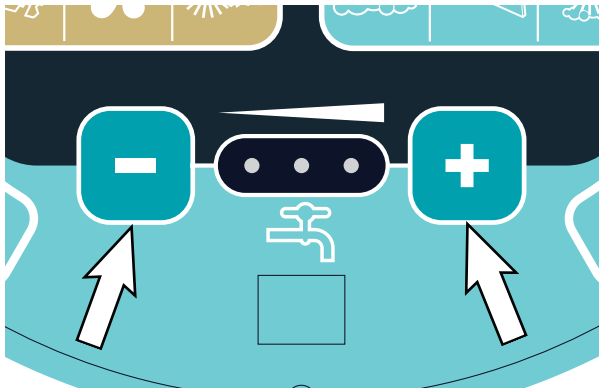

SETTING THE SOLUTION FLOW - PRO-PANEL

Press the *solution flow button* to access the *solution increase (+)* button, the *solution decrease (-)* button, and the *solution flow indicator bar*.



Use the *solution increase (+)* button and the *solution decrease (-)* button to set the solution flow level. The *solution flow indicator bar* displays the current solution flow setting.

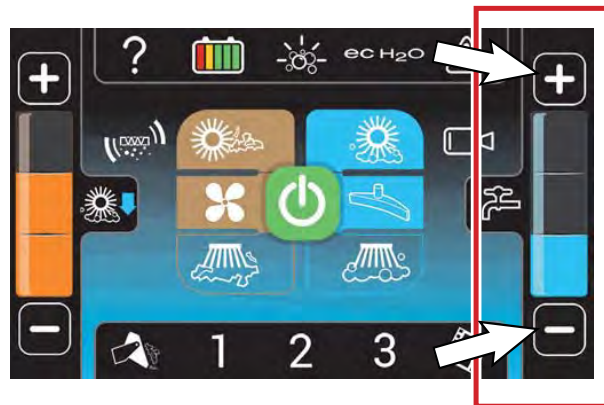

OPERATION

SCRUBBING / SWEEPING - STANDARD PANEL

FOR SAFETY: Do not operate machine, unless operator manual is read and understood.

1. Turn on the machine.
2. Press the *1-STEP button*. The light above the button will come on. All the preset scrubbing / sweeping functions will turn on.

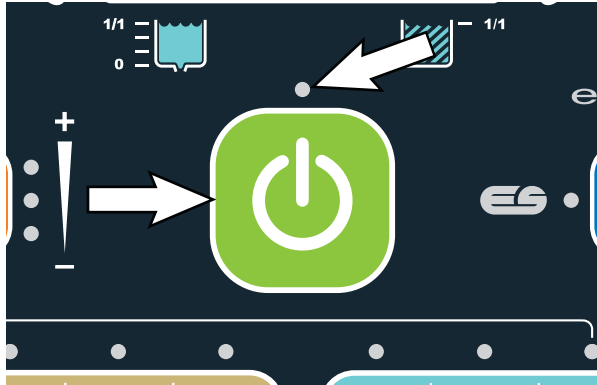

3. If necessary, activate the scrubbing / sweeping functions required for the area to be cleaned.
4. If necessary, adjust the scrubbing brush pressure and solution flow.
5. Release the parking brake.
6. Place the *directional switch* in the forward position.
7. Press the *propel pedal* to begin scrubbing / sweeping.

NOTE: DO NOT turn on the ec-H2O system during conventional scrubbing. Conventional cleaning detergents could cause an ec-H2O system failure. Drain, rinse, and refill the solution tank with cool clean water before operating the ec-H2O system.



WARNING: Flammable materials or reactive metals can cause an explosion or fire. Do not pick up.

FOR SAFETY: When using machine, go slowly on inclines and slippery surfaces.

NOTE: Press the sweep vacuum fan button to turn off the vacuum fan when sweeping over large wet areas or standing water. This prevents the hopper dust filter from getting wet while sweeping.

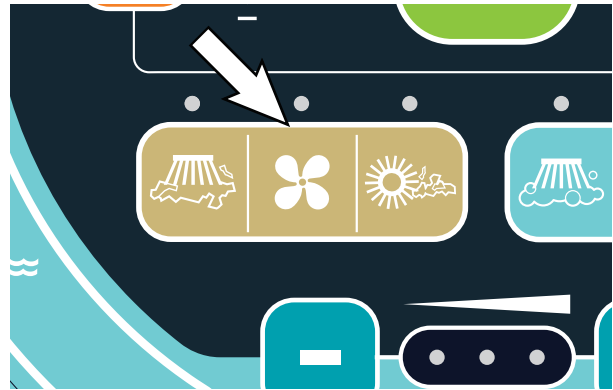

NOTE: The squeegee automatically rises when the machine is driven in reverse. This prevents damage to the squeegee.

8. Release the *directional pedal* and press the brake pedal to stop the machine.
9. Press the *1-STEP button* to stop scrubbing / sweeping. The light near the button will go off and the scrubbing / sweeping functions will stop after a short delay.

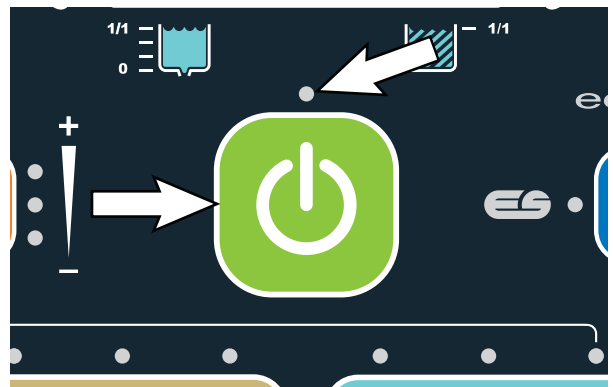

NOTE: If the machine was using the sweeping functions, the filter shaker automatically shakes the filter for a short time each time the 1-STEP button is turned off.

NOTE: If there is a fault or alert code during machine operation, stop the machine and refer to the FAULTS / ALERTS section of this manual for the cause and the corrective action for eliminating the fault or alert.

10. Empty the debris hopper and recovery tank at the end of each shift or as needed. See **EMPTYING THE HOPPER** and **DRAINING AND CLEANING THE RECOVERY TANK** sections of this manual.

SCRUBBING / SWEEPING - PRO-PANEL

FOR SAFETY: Do not operate machine, unless operator manual is read and understood.

1. Turn on the machine.
2. If applicable, log into the machine. See *PRO-ID LOGIN SCREEN*.
3. If applicable, complete the Pro-Check Pre-Operation Checklist. See *COMPLETING THE PRO-CHECK PRE-OPERATION CHECKLIST*.
4. Press the *1-STEP button*. The *1-STEP button* and all other selected scrubbing / sweeping buttons will illuminate.

NOTE: Make sure the scrubbing / sweeping modes are set before cleaning.



5. If necessary, adjust the scrubbing brush pressure and solution flow.



6. If necessary, activate the scrub mode or zone setting required for the area to be cleaned.
7. Release the parking brake.
8. Place the *directional switch* in the forward position.

9. Press the *propel pedal* to begin scrubbing.

NOTE: DO NOT turn on the ec-H₂O system during conventional scrubbing. Conventional cleaning detergents could cause an ec-H₂O system failure. Drain, rinse, and refill the solution tank with cool clean water before operating the ec-H₂O system.



WARNING: Flammable materials or reactive metals can cause an explosion or fire. Do not pick up.

FOR SAFETY: When using machine, go slowly on inclines and slippery surfaces.

NOTE: Press the sweep vacuum fan button to turn off the vacuum fan when sweeping over large wet areas or standing water. This prevents the hopper dust filter from getting wet while sweeping.



NOTE: The squeegee automatically rises when the machine is driven in reverse. This prevents damage to the squeegee.

10. Press the *rearview camera button* at any time to check cleaning performance behind the machine.



11. Release the *directional pedal* and press the brake pedal to stop the machine.

OPERATION

12. Press the *1-STEP button* to stop scrubbing / sweeping. The button will no longer be illuminated and scrubbing / sweeping functions will stop after a short delay.

NOTE: If the machine was using the sweeping functions, the filter shaker automatically shakes the filter for a short time each time the 1-STEP button is turned off.

NOTE: If there is a fault or alert code during machine operation stop the machine and refer to the FAULTS / ALERTS section of this manual for the cause and the corrective action for eliminating the fault or alert.

13. Empty the debris hopper and recovery tank at the end of each shift or as needed. See *EMPTYING THE HOPPER* and *DRAINING AND CLEANING THE RECOVERY TANK* sections of this manual.

DOUBLE SCRUBBING

Double scrubbing is the process of making two or more passes over a heavily soiled area. The first pass is made with the rear and side squeegees raised to allow the solution to soak into the floor. Use the double scrubbing method to clean heavily soiled areas.

Double scrubbing can be performed using the *ec-H2O SCRUBBING SYSTEM* (option), *ES SCRUBBING SYSTEM* (option), or *CONVENTIONAL SCRUBBING* methods.

Manually lift both side squeegee assemblies and position the double scrub latch to hold the squeegees in the raised position.

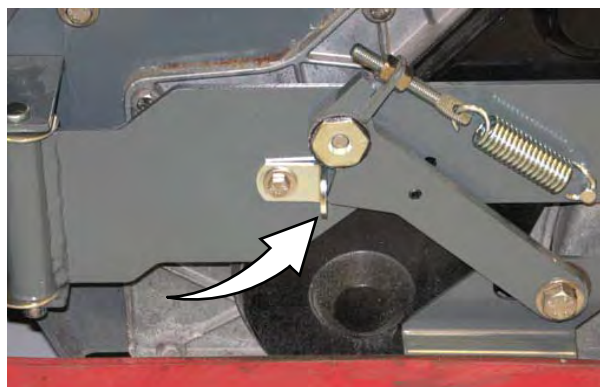
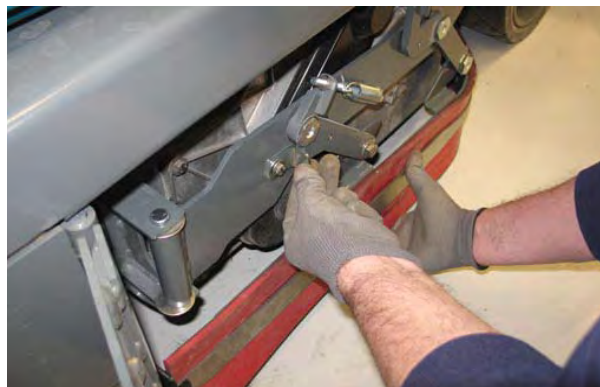

Machines equipped with standard panel: Press the *1-STEP* button and then the *vacuum fan / squeegee* button. The light above the *vacuum fan / squeegee* button will turn off, the squeegee will rise, and the vacuum fan will stop operating.



Standard Panel

Machines equipped with Pro-Panel: Press the *1-STEP* button and then the *vacuum fan / squeegee* button. The *vacuum fan / squeegee* button will no longer be illuminated, the squeegee will rise, and the vacuum fan will stop operating.



Pro-Panel

Scrub the heavily soiled area. Let the cleaning solution soak on the floor for 5-15 minutes.

FOR SAFETY: When using machine, go slowly on inclines and slippery surfaces.

Before scrubbing the floor a second time, lower the side squeegees and press the *vacuum fan / squeegee* button to lower the rear squeegee and turn on the vacuum fan. The light above the button will come on. Scrub the floor a second time to pick up the cleaning solution.



WARNING: Flammable materials or reactive metals can cause an explosion or fire. Do not pick up.

NOTE: If needed, reduce solution flow when scrubbing the floor for a second time.

NOTE: Double scrubbing is not recommended in areas where the cleaning solution will run under racks or damage products.

OPERATION

WATER PICKUP MODE (NO SCRUBBING)

The machine can be used to pick up water or non-flammable liquid spills without scrubbing.



WARNING: Flammable materials or reactive metals can cause an explosion or fire. Do not pick up.

Before picking up water or non-flammable liquid spills, make sure the *1-STEP button* is activated and all other cleaning functions are off.

Machines equipped with standard control panel: Press the *scrubbing vacuum fan / squeegee button*. The light above the button will illuminate, the squeegee will lower, and the vacuum fan will start operating. Pick up the water or non-flammable liquid spill.



Standard Panel

Machines equipped with Pro-Panel controls: Press the *scrubbing vacuum fan / squeegee button*. The button will illuminate, the squeegee will lower, and the vacuum fan will start operating. Pick up the water or non-flammable liquid spill.



Pro-Panel

STOP CLEANING

1. While the machine is still in motion, press the *1-STEP button* to stop cleaning. The squeegee will briefly remain lowered to the floor to pick up the water in the scrub head, and then raise.
2. Release the *directional pedal* and press the *brake pedal* to stop the machine.

EMPTYING THE HOPPER

EMPTYING THE HOPPER - STANDARD PANEL

1. Drive the machine to a debris site or container.
2. Press the *filter shaker switch*. The shaker operates for approximately 30 seconds. The indicator light comes on while the filter shaker is operating. Press the top of the filter shaker switch again if necessary to stop the filter shaker.

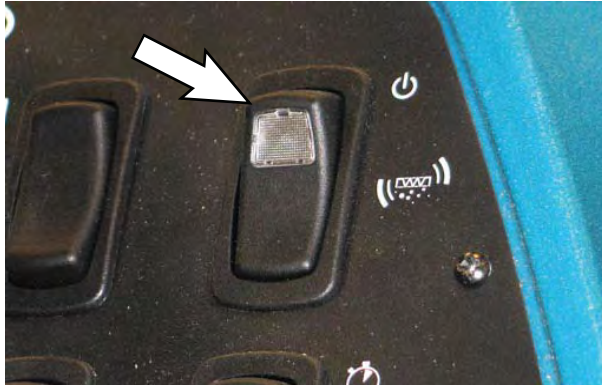

3. After the filter shaker stops, press and hold the top of the *hopper raise / lower switch* to raise the hopper. Release the button when the hopper is at the desired position.

FOR SAFETY: When using machine, make sure adequate clearance is available before raising hopper. Do not raise hopper when machine is on an incline.

NOTE: Be aware the minimum ceiling height needed to raise the hopper is 2134 mm (84 in).



4. Slowly drive the machine up to the debris container. Position the hopper over the debris container.

FOR SAFETY: When using machine, use care when reversing machine. Move machine with care when hopper is raised.

5. Press and hold the top of the *hopper roll switch* to empty the contents from the hopper.



6. Press and hold the bottom of the *hopper roll switch* to return the hopper to the upright position.



7. Slowly back the machine away from the debris site or container.
8. Stop the machine, then press and hold the bottom of the *hopper raise / lower switch* until the hopper is completely lowered.



OPERATION

EMPTYING THE HOPPER - PRO-PANEL

1. Drive the machine to a debris site or container.
2. Press the *filter shaker button*. The shaker operates for approximately 30 seconds. The *filter shaker button* is illuminated while the filter shaker is operating. Press the *filter shaker button* again if necessary to stop the filter shaker.



3. After the filter shaker stops, press the *hopper control button* to access the hopper controls.



4. Press and hold the *hopper raise button* to raise the hopper. Release the button when the hopper is raised.

FOR SAFETY: When using machine, make sure adequate clearance is available before raising hopper. Do not raise hopper when machine is on an incline.

NOTE: Be aware the minimum ceiling height needed to raise the hopper is 2134 mm (84 in).



5. Slowly drive the machine up to the debris container. Position the hopper over the debris container.

FOR SAFETY: When using machine, use care when reversing machine. Move machine with care when hopper is raised.

6. Press and hold the *hopper roll out button* to empty the hopper. Release the *hopper roll out button* when all debris has been emptied from the hopper.



7. Press and hold the *hopper roll in button* to bring the hopper back to the upright position. Release the *hopper roll in button* when hopper is retracted to the upright position.



8. Slowly back the machine away from the debris site or container.
9. Stop the machine, then press and hold the *hopper lower button* until the hopper is completely lowered.



10. Press either the *home button* or the *back button* to return to the main operating screen.



OPERATION

ENGAGING THE HOPPER SUPPORT BAR

1. Set the machine *parking brake*.



FOR SAFETY: When starting machine, keep foot on brake and directional pedal in neutral.

2. Turn on the machine.
3. Completely raise the hopper.



WARNING: Lift arm pinch point. Stay clear of hopper lift arms.

FOR SAFETY: When using machine, make sure adequate clearance is available before raising hopper. Do not raise hopper when machine is on an incline.

NOTE: Be aware that the minimum ceiling height needed to high dump the hopper is 2134 mm (84 in).

4. Lower and position the hopper support bar onto the support bar stop.

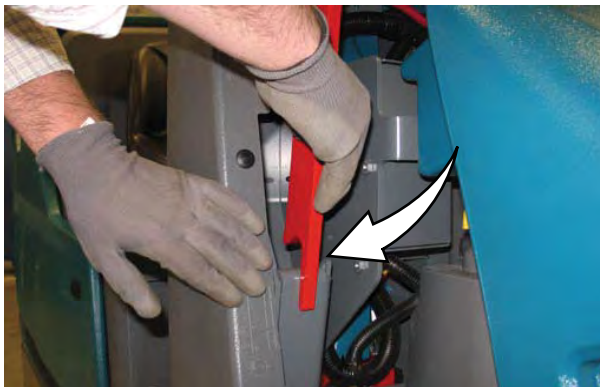

WARNING: Raised hopper may fall. Engage hopper support bar.

5. Slowly lower the hopper until the hopper support bar rests on the support bar stop.

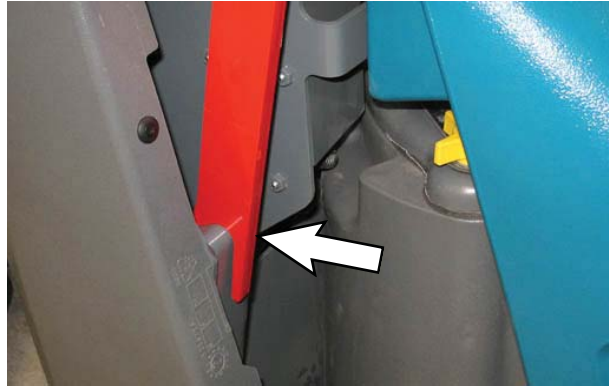

6. Turn off the machine.

DISENGAGING THE HOPPER SUPPORT BAR

1. Turn on the machine.

FOR SAFETY: When starting machine, keep foot on brake and directional pedal in neutral.

2. Slightly raise the hopper. Release the switch / button when the hopper is raised.
3. Put the support bar in its storage position.



WARNING: Lift arm pinch point. Stay clear of hopper lift arms.

4. Completely lower the hopper.

DRAINING AND CLEANING THE RECOVERY TANK

Drain and clean the recovery tank daily or when the recovery tank full fault code appears on the LCD display.

Clean the outside of the tank with vinyl cleaner.

1. Drive the machine near a floor drain.
2. Lower the *rear bumper door / step*.

FOR SAFETY: Before leaving or servicing machine, stop on level surface, turn off machine, set parking brake, and remove key.

3. Unhook the recovery tank drain hose from the recovery tank.

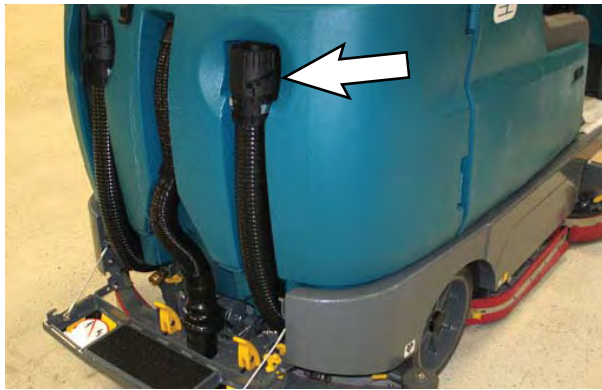

4. Hold the drain hose near a floor drain, twist the drain nozzle open, and place the hose near the floor drain.

NOTE: Be sure the drain hose nozzle is pointed in a safe direction before opening the nozzle.



5. If necessary, twist the drain nozzle to another position to adjust the flow rate.

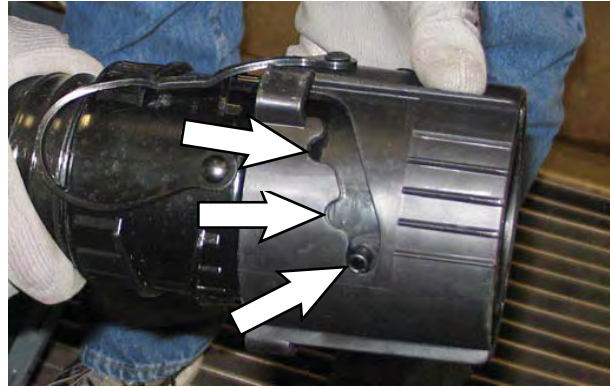

6. Lift the recovery tank cover and flush out the recovery tank with clean water. Rinse the sensor near the top of the tank.

ES machines only: Clean the second lower sensor (not shown).

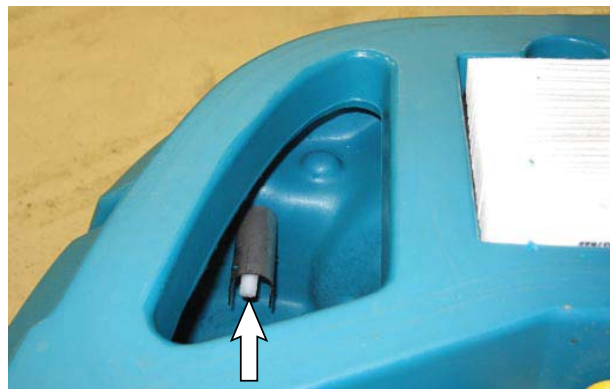
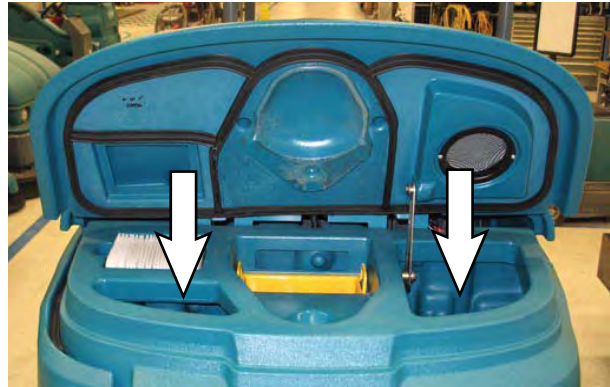

OPERATION

7. ES machines: Rinse the ES filter at the bottom of the recovery tank

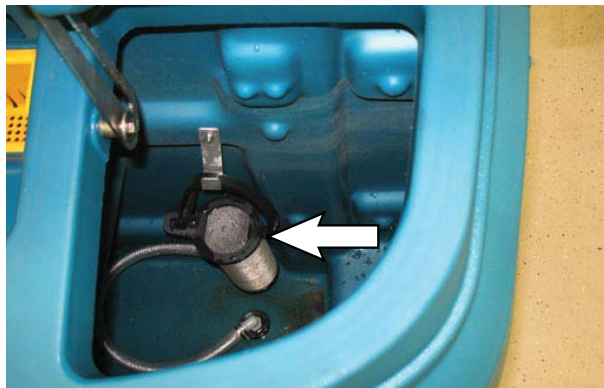

8. To prevent leaks, clean the plug portion of the nozzle and the interior of the drain hose cuff.



NOTE: DO NOT use steam to clean the tanks. Excessive heat can damage the tanks and components.

9. Twist the drain cuff closed and insert the drain hose back into the clip on the recovery tank.



10. Check the vacuum fan inlet filter daily. Clean inlet filter with a damp cloth or hose when dirty. Allow filter to completely dry before reinstalling it into the machine.



11. Remove the vacuum screen from the recovery tank cover and rinse the screen.



12. Remove the debris tray from the recovery tank and rinse all debris from the tray.



13. Close the recovery tank cover.

14. Cylindrical scrub head: Remove and clean the debris trough. Place the trough back in the scrub head when clean.



NOTE: The scrub head must be lowered approximately 25 mm (1 in) to remove debris trough.

NOTE: The debris trough can be removed from the right side of the machine only.

15. Raise the rear bumper door / step.

OPERATION

DRAINING AND CLEANING THE SOLUTION TANK

Machines equipped with ES (Extended Scrub) only: Drain and clean the solution tank daily.

Clean the outside of the tank with vinyl cleaner.

1. Drive the machine near a floor drain.

FOR SAFETY: Before leaving or servicing machine, stop on level surface, turn off machine, set parking brake, and remove key.

2. Lower the *rear bumper door / step*.
3. Remove the solution tank drain hose from the solution tank.

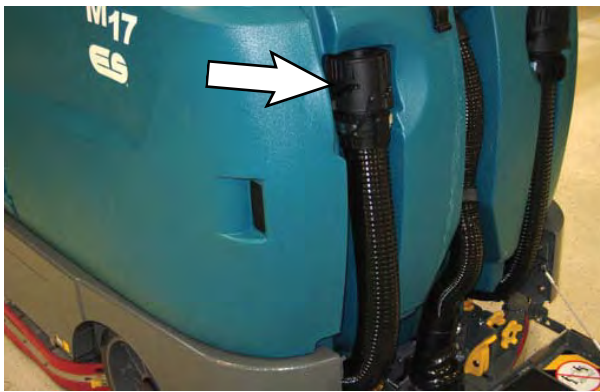

4. Hold the drain hose near a floor drain, twist the drain nozzle open, and place the hose near the floor drain.

NOTE: Be sure the drain hose nozzle is pointed in a safe direction before opening the nozzle.



5. If necessary, twist the drain nozzle to another position to adjust the flow rate.

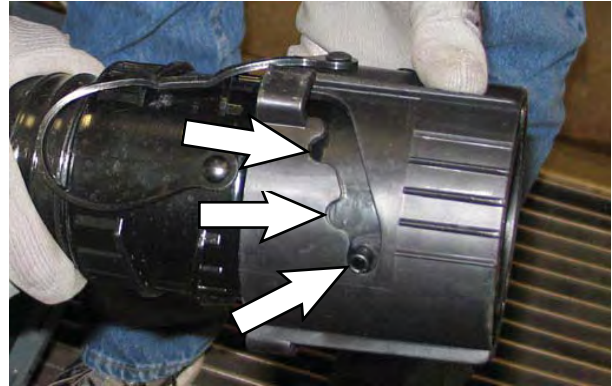

6. Twist the handle and lift the solution tank cover open and flush out the solution tank with clean water. Rinse the ES filter located at the bottom of the tank.

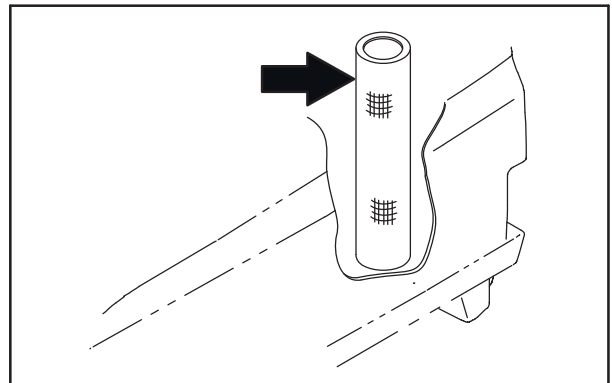

NOTE: DO NOT use steam to clean the tanks. Excessive heat can damage the tanks and components.

7. To prevent leaks, clean the plug portion of the nozzle and the interior of the drain hose cuff.

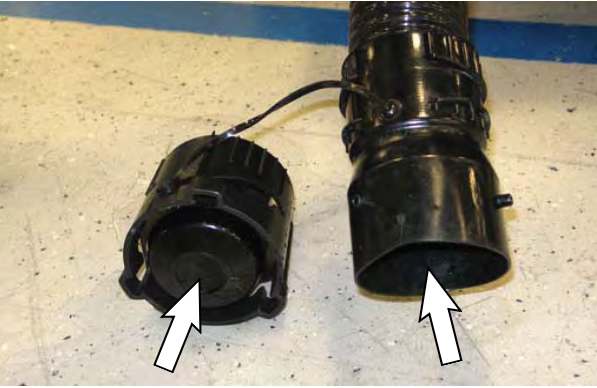

8. Twist the drain cuff closed and insert the drain hose back into the clip on the solution tank.



9. Raise the rear bumper door / step.

TURN OFF THE MACHINE

1. Remove foot from the *propel pedal*.
2. Press the *1-STEP button* to stop scrubbing.
3. Press the *brake pedal* to stop the machine.
4. Turn the *key switch* to the OFF position and remove the key.

FOR SAFETY: Before leaving or servicing machine, stop on level surface, turn off machine, set parking brake, and remove key.



FAULTS / ALERTS

The operator will receive a fault / alert warning when there is a mechanical / electronic issue with the machine.

To reset the fault / alert indicators, turn off the machine and then eliminate the cause of the fault / alert. The fault / alert indicator will reset when the machine is restarted.

Refer to the fault / alert indicators table to determine the cause and remedy for the fault / alert.

FAULT / ALERT INDICATORS - STANDARD PANEL

This machine is equipped with two visual indicators, a red indicator light and an LCD (liquid crystal display).

The red indicator light will blink continuously indicating that a fault / alert has occurred.

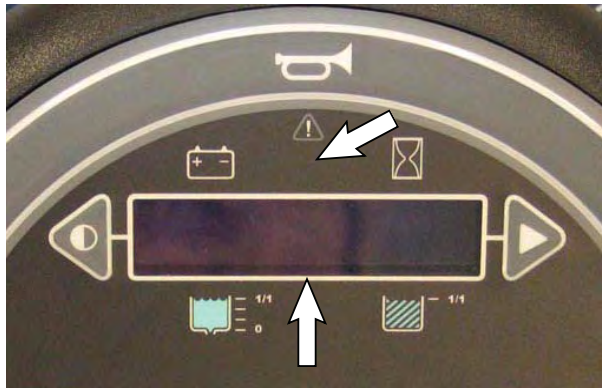



The LCD will display a fault / alert code. If there is more than one fault, each fault code will alternately display.

FAULT / ALERT INDICATORS - PRO-PANEL

The *fault / alert indicator button* will flash continuously indicating a fault / alert has occurred. The multicolored background will change to a black background





 Press the flashing *red fault indicator button* to view the faults. A fault / alert screen will appear in the display.

 Press the flashing *yellow alert indicator button* to view the alerts. A fault / alert screen will appear in the display.

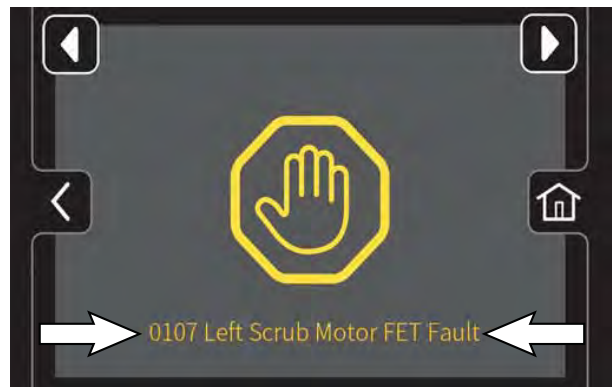
Fault / alert text will appear under the icon in the center of the screen.



 Press *right arrow button* to scroll forward through the faults / alerts.

 Press *left arrow button* to scroll back through the faults / alerts.

 Press the *home button* to return to the main operating screen.

 Press the *back arrow button* to return to the previous screen.

FAULT / ALERT INDICATORS				
Fault Code Number	Fault Code Standard Panel	Fault Code Pro-Panel	Cause(s)	Remedy
FFF0	E Stop	Emergency Stop Fault	Emergency Stop engaged	Release Emergency Stop
FF12	Low Battery	Very Low Battery Warning	Very low battery charge	Charge battery
FF11	Low Battery	Low Battery Warning	Low battery charge	Charge battery
07A2		Hopper not in Home position	Hopper not completely lowered	Completely lower hopper
07A1	Hopper Fire	Hopper on Fire	Fire in hopper	Shut off machine. Extinguish fire. if necessary, call emergency personnel.
07A0		Clogged Filter Warning	Filter clogged with dust and debris	Engage filter shaker. Clean filter.
0790	SolTnk Empty	Solution Tank Empty	Solution tank is empty	Fill solution tank
0791	RcvTnk Full	Recovery Tank Full	Recovery tank is full	Empty recovery tank
0701	Ec Flsh Flt	ec-H2O System Flush Needed	ec-H2O system plugged with impurities	Flush ec-H2O system
0010	Parking Brk	Parking Brake	Parking brake engaged	Release parking brake
0101	L Scrub Opn	Left Scrub Motor Electrical Open Alert	Electrical fault	Contact qualified Tennant service representative.

NOTE: Contact a Tennant Service representative for all other fault codes.

OPTIONS

SPRAY NOZZLE (OPTION)

The spray nozzle is used to clean the machine and surrounding areas. The solution tank provides a water/solution supply for the spray nozzle.

FOR SAFETY: When servicing machine, do not power spray or hose off machine near electrical components.

FOR SAFETY: Before leaving or servicing machine and stop on level surface and set parking brake.

1. Turn on the machine.
2. Press the top of the *spray nozzle switch* to turn on the spray nozzle. The light on the switch will come on when the spray nozzle is turned on.

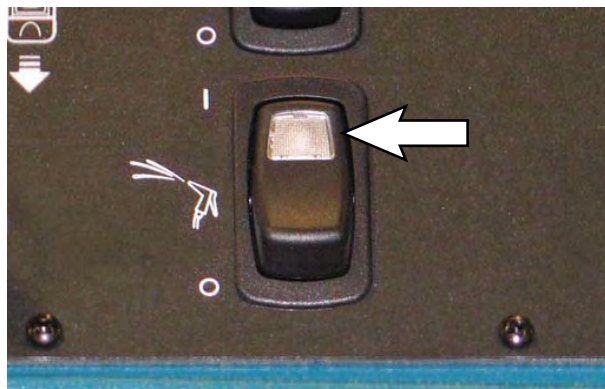

3. Open the left shroud to access the spray nozzle.

4. Pull the spray nozzle out from the back of the machine and clean as needed.

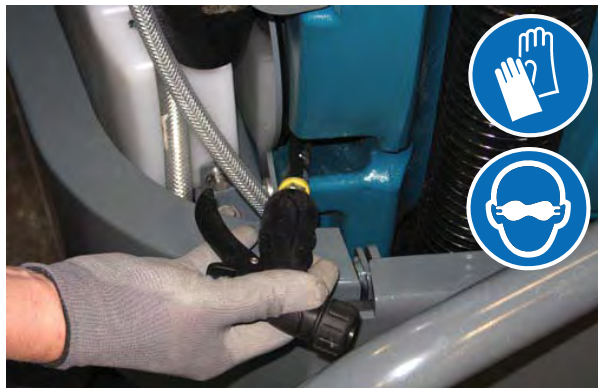

5. When finished cleaning, gently pull the hose and allow the spray nozzle hose to retract back into the machine.

NOTE: Continue holding onto the spray nozzle and control the hose while it is retracting back into the machine. The machine and / or the spray nozzle assembly could be damaged if the spray nozzle hose is released and allowed to rapidly retract into the machine.

6. Press the bottom of the *spray nozzle switch* to turn off the water supply. The light on the switch will turn off when the spray nozzle is turned off.

NOTE: Be sure the spray nozzle switch is turned off before continuing scrubbing. The spray nozzle pump could be damaged if the switch is left on while scrubbing.

VACUUM WAND (OPTION)

Use the vacuum wand to clean areas that are out of reach of the machine.



WARNING: Flammable materials or reactive metals can cause an explosion or fire. Do not pick up.

FOR SAFETY: Before leaving or servicing machine and stop on level surface and set parking brake.

1. Lower the *rear bumper door / step*.
2. Remove the vacuum wand components from the storage tray located on top the battery compartment cover.

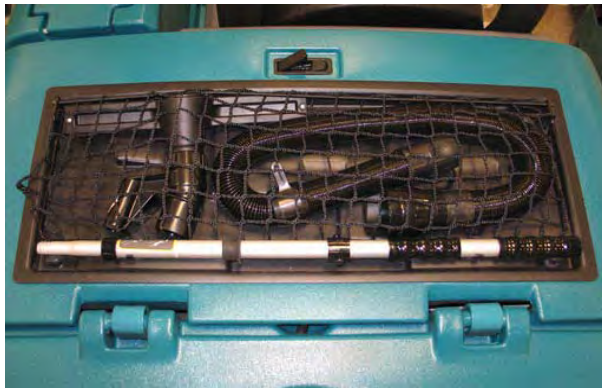

3. Disconnect the vacuum hose from the rear squeegee.



4. Connect the vacuum wand hose to the rear squeegee vacuum hose.

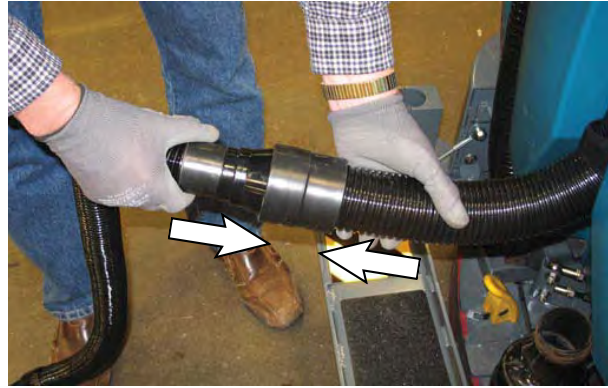

5. Connect the vacuum wand nozzle to the vacuum wand nozzle hose.



6. Insert and tighten the vacuum wand handle into the vacuum wand nozzle.



OPERATION

7. Secure the vacuum wand hose collar to the vacuum hose handle.



8. Extend the vacuum wand handle to the desired length and twist the vacuum wand handle to tighten.

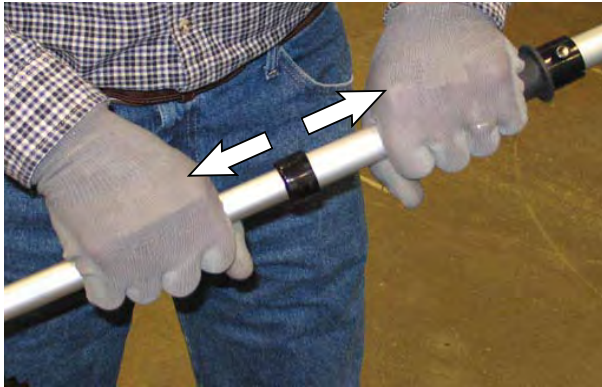

9. Turn on the machine.
10. Press the *vacuum fan / squeegee button* to turn on the vacuum fan. The squeegee will completely lower.

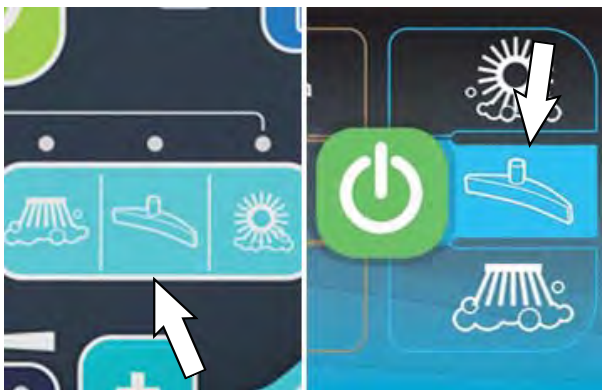

Standard Panel

Pro-Panel

11. Vacuum the floor.



12. When finished vacuuming, press the *vacuum fan / squeegee button* to turn off the vacuum fan. The squeegee will raise.
13. Turn off the machine.
14. Disconnect the vacuum wand hose from the rear squeegee vacuum hose and disassemble the vacuum wand.
15. Return the vacuum wand components to the storage tray located on top the battery compartment cover.
16. Reconnect the vacuum hose to the rear squeegee.
17. Lift the *rear bumper door / step* to the raised position and secure to the rear bumper.

SLIDE OUT BATTERY (OPTION)

The slide out battery allows the operator a quick and easy way to remove and replace the batteries. Use proper battery pulling and lifting equipment and procedures based on the battery size and weight. See *SPECIFICATIONS* section. The battery slide out height is 508 mm (20 in.).

FOR SAFETY: Before leaving or servicing machine, stop on level surface, turn off machine, set parking brake, and remove key.

1. Lift the battery compartment cover open and engage the support.

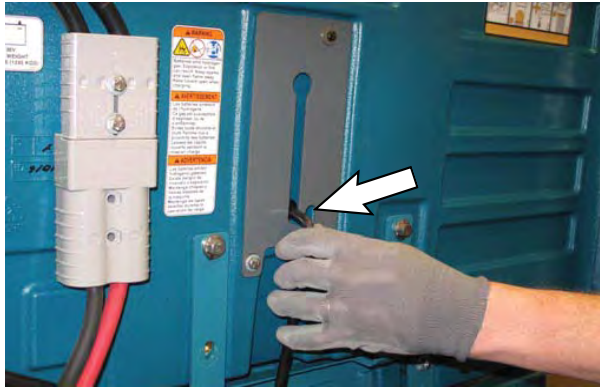

2. Open the right shroud.



3. Disconnect the battery cable from the machine connector.



4. Remove the battery retainer plate from the machine.



5. Position the battery cart near the battery compartment.

FOR SAFETY: When servicing machine: Keep all metal objects off batteries. Use a non-conductive battery removal device. Use a hoist and adequate assistance when lifting batteries. Battery installation must be done by trained personnel. Follow site safety guidelines concerning battery removal.

6. Slide the battery from the machine and onto the battery cart.
7. Install the new battery into the battery compartment.
8. Reinstall the battery retainer plate onto the machine. The retainer plate must press the switch completely down into the engaged position. The machine will not function if the switch is not engaged.

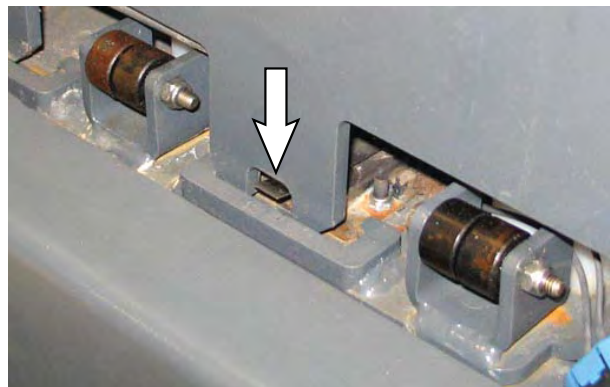

9. Close the battery compartment side cover and top cover.

OPERATION

REAR SQUEEGEE GUARD (OPTION)

The rear squeegee protector helps protect the rear squeegee from being damaged.



To engage the rear squeegee protector, pull the pin, lower the protector bar, and reinsert the pin.



ADJUSTING BACKUP ALARM VOLUME (OPTION)

FOR SAFETY: When using machine, follow site safety guidelines concerning backup alarms.

The backup alarm volume can be adjusted from 85–102 dB(A). To adjust the volume, remove the backup alarm cover and turn the volume knob.

Increase volume: Turn the knob clockwise.

Decrease volume: Turn the knob counter-clockwise.

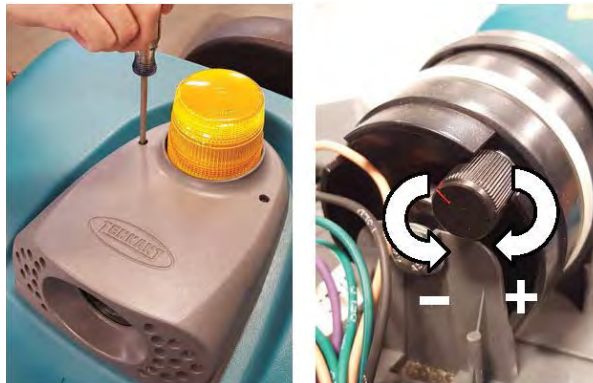

MACHINE TROUBLESHOOTING

Problem	Cause	Remedy
Machine will not operate	Emergency stop button activated	Reset emergency stop button
	Machine fault detected	See FAULT INDICATORS or WARNING CODES
	Discharged battery	Charge battery
	Loose battery cable(s)	Tighten loose cable(s)
	Faulty battery	Replace battery
	Faulty key switch	Contact Tennant service representative
	Faulty control board	Contact Tennant service representative
Trailing water - poor or no water pickup	Squeegee blades worn	Rotate or replace squeegee blades
	Squeegee out of adjustment	Adjust squeegee
	Clogged squeegee assembly	Clean squeegee assembly
	Vacuum hose loose	Secure vacuum hose connections
	Vacuum hose damaged	Replace vacuum hose
	Vacuum fan inlet filter dirty	Clean inlet filter
	Debris caught on squeegee	Remove debris from squeegee
	Vacuum hose to squeegee or recovery tank disconnected or damaged	Reconnect or replace vacuum hose
	Tank cover not completely closed	Check for obstructions
	Torn seals on recovery tank	Replace seals
Scrubbing vacuum fan will not turn on	Recovery tank full	Drain recovery tank
	Foam filling recovery tank	Empty recovery tank
		Use less or change detergent
	Use a defoamer	
Little or no solution flow to the floor	Solution tank empty	Fill solution tank
	Solution flow turned off	Turn solution flow on
	Solution supply lines plugged	Flush solution supply lines
	Solution solenoid clogged or stuck	Clean or replace
Poor scrubbing performance	Debris caught on scrub brushes	Remove debris from brushes
	Improper detergent / brushes pads used	Contact Tennant representative for recommendations
	Scrub brushes pads worn	Replace scrub brushes / pads
	Excessive brush pressure	Reduce scrub brush down pressure
	Uneven brush pressure	Level scrub head
	Debris trough full	Empty debris trough
	Broken brush drive belts on cylindrical scrub head	Replace belts
	Low battery charge	Charge battery until the charger automatically turns off

OPERATION

Problem	Cause	Remedy
Excessive dusting	Brush skirts and dust seals worn, damaged, or out of adjustment	Replace or adjust brush skirts and/or brush seals
	Hopper dust filter clogged	Shake and / or replace dust filter
	Sweep vacuum fan seal damaged	Replace vacuum fan seal
	Sweep vacuum fan failure	Contact Tennant service representative
	Thermo-Sentry tripped	Allow Thermo-Sentry to cool
	Sweeping vacuum fan off	Turn on vacuum fan
	Perma-Filter clogged	Clean Perma-Filter
Poor sweeping performance	Worn brush bristles	Replace brushes
	Debris caught in main brush drive mechanism	Remove debris from main brush drive mechanism
	Main and/or side brush drive failure	Contact Tennant service representative
	Hopper full	Empty hopper
	Hopper lip skirts worn or damaged	Replace lip skirts
	Wrong sweeping brush	Contact Tennant service representative
Reduced run time	Battery not fully charged	Charge battery until the charger automatically turns off
	Defective battery	Replace battery
	Batteries need maintenance	See <i>BATTERIES</i> in <i>MAINTENANCE</i>
	Faulty battery charger	Replace battery charger
ES System does not function	<i>ES button</i> is turned off	Turn on <i>ES button</i>
	ES sensor in tank dirty or not in correct position	Clean / reposition sensor
	Clogged ES pump filter	Clogged ES pump filter
	Water level in recovery tank too low	Fill recovery tank approximately half full
	Water level in solution tank too low	Fill solution tank
Sweeping or Scrubbing functions do not turn on	Hopper is up	Completely lower hopper
	Fire in the hopper	Turn off machine. Extinguish fire. If necessary, call emergency personnel.
	Recovery tank full	Press the Scrub vacuum fan/squeegee button for one minute of extended water pickup. Empty recovery tank. ES models: Activate the ES system to prevent this.

Problem	Cause	Remedy
<i>ec-H2O</i> Model: Warning and fault indicator light blinking red	Mineral deposit build-up in module	Flush module (See <i>ec-H2O</i> MODULE FLUSH PROCEDURE)
<i>ec-H2O</i> Model: Warning and fault indicator light solid red	Clogged module	Contact Tennant service representative
	Defective solution pump	Replace solution pump

MAINTENANCE

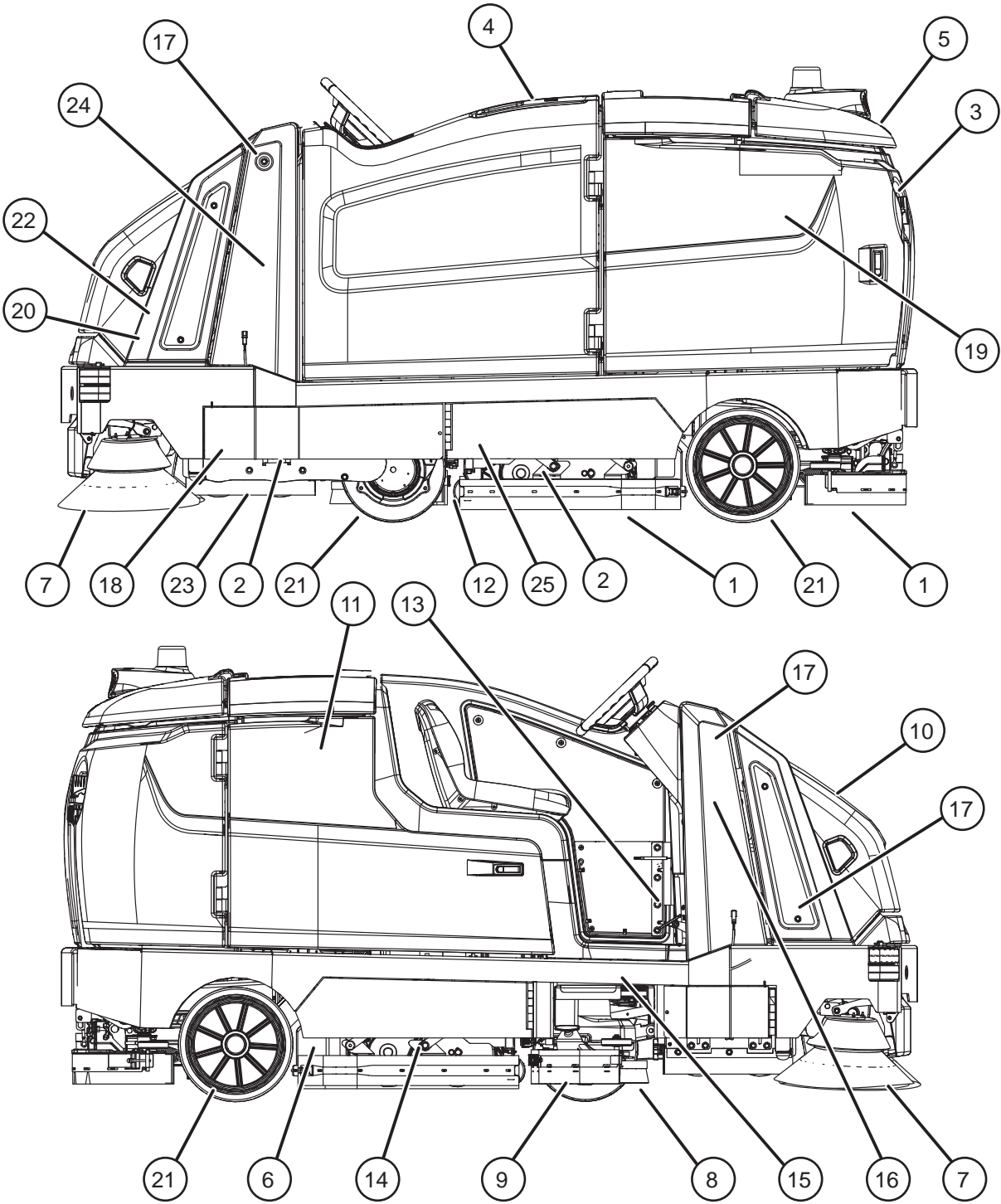

MAINTENANCE CHART

The table below indicates the Person Responsible for each procedure.

O = Operator.

T = Trained Personnel.

NOTE: Check procedures indicated (■) after the first 50 hours of operation.

Interval	Person Resp.	Key	Description	Procedure	Lubricant/ Fluid	No. of Service Points
Daily	O	22	Hydraulic reservoir	Check hydraulic fluid level	HYDO	1
	O	1	Side and rear squeegees	Check for damage and wear. Check deflection.	-	4
	O	2	Main brushes and pads	Check for damage, wear, and debris	-	2
	O	3	Recovery tank	Clean tank, top sensor, and check cover seal	-	1
	O	4	Solution tank	Check cover seal	-	1
	O	3	ES machines only: Recovery tank	Clean tank and level sensor	-	2
	O	4	ES machines only: Solution tank	Clean tank and level sensor	-	1
	O	5	Vacuum fan inlet filter, screen, and debris tray	Clean	-	1
	O	6	Cylindrical brushes only: Debris trough	Clean	-	1
	O	7	Sweeping side brush(es)	Check for damage, wear, debris	-	1 (2)
	O	8	Scrubbing side brush	Check for damage, wear, debris	-	1
	O	9	Scrubbing side brush squeegee	Check for damage and wear	-	1
	O	10	Hopper dust filter	Shake to clean	-	1
Weekly	T	11	Battery cells	Check electrolyte level	DW	Multiple
50 Hours	T	1	Side and rear squeegees	Check leveling	-	4
	O	1	Main brushes (cylindrical)	Rotate brushes from front to rear	-	2
	O	12	Scrub head skirts (disk)	Check for damage and wear	-	2
	O	23	Sweeping skirts	Check for damage and wear	-	4
	O	7	Sweeping side brush(es)	Check brush pattern	-	2
	O	25	Solution supply filter	Check screen and clean	-	1

LUBRICANT/FLUID

DW Distilled water.

SPL Special lubricant, Lubriplate EMB grease (Tennant part number 01433-1)

GL SAE 90 weight gear lubricant

HYDO **Tennant True** premium hydraulic fluid or equivalent

NOTE: More frequent maintenance intervals may be required in extremely dusty conditions.

MAINTENANCE

The table below indicates the Person Responsible for each procedure.

O = Operator.

T = Trained Personnel.

NOTE: Check procedures indicated (■) after the first 50 hours of operation.

Interval	Person Resp	Key	Description	Procedure	Lubricant/ Fluid	No. of Service Points	
100 Hours	T	11	Battery watering system (option)	Check hoses and connections for damage and wear	-	Multiple	
	T	10	Hopper seals	Check for damage and wear	-	2	
	T	10	Hopper	Clean hopper, dust filter and Perma-Filter		1	
200 Hours	T	13	Brakes	Check adjustments	-	1	
	T	11	Battery terminals and cables	Check and clean	-	Multiple	
	T	14	Cylindrical brush drive belts	Check for damage and wear	-	2	
	T	18	Sweeping brush drive belts	Check for damage and wear	-	2	
	T	15	Drive wheel pivot	Lubricate	SPL	1	
	T	15	Steering chain	Lubricate and check for damage and wear.	GL	1	
			16	Steering gear chain	Lubricate and check for damage and wear	GL	1
	T	24	Hopper chains	Lubricate and check for damage and wear.	GL	2	
	T	17	Hopper lift arm pivots	Lubricate	SPL	3	
500 Hours	T	19	Scrub vacuum fan motor(s)	Check motor brushes	-	1 (2)	
	O	21	Tires	Check for damage and wear	-	3	
	T	24	Hopper chains	■ Check tension.	-	2	
800 Hours	T	22	Hydraulic hoses	Check for wear and damage	-	Multiple	
1000 Hours	T	7	Sweeping side brush motors	Check motor brushes (Check every 100 hours after initial 1000 hour check)	-	2	
2400 Hours	T	22	Hydraulic reservoir	Change hydraulic fluid	HYDO	1	

LUBRICANT/FLUID

DW Distilled water.

SPL Special lubricant, Lubriplate EMB grease (Tennant part number 01433-1)

GL SAE 90 weight gear lubricant

HYDO **Tennant True** premium hydraulic fluid or equivalent

NOTE: More frequent maintenance intervals may be required in extremely dusty conditions.

YELLOW TOUCH POINTS

This machine features easy to find yellow touch points for simple service items. No tools are required to perform these maintenance operations.

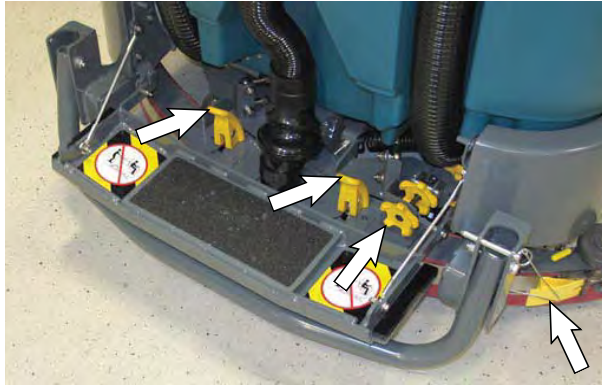

LUBRICATION

FOR SAFETY: Before leaving or servicing machine, stop on level surface, turn off machine, set parking brake, and remove key.

STEERING CHAIN

The steering chain is located on the steering column directly under the control panel. Check for damage or wear and lubricate the steering chain after every 200 hours.



STEERING GEAR CHAIN

The steering gear chain is located directly above the front tire. Check for damage or wear and lubricate the steering gear chain after every 200 hours.

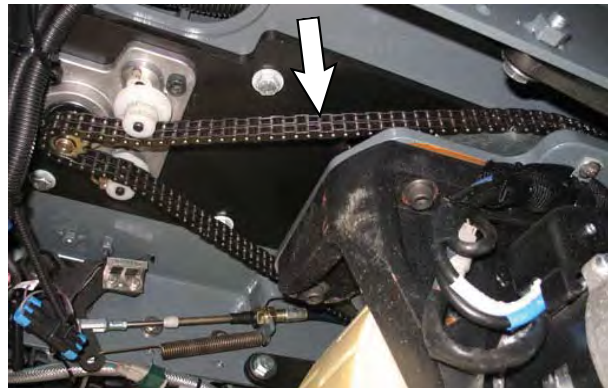

DRIVE WHEEL PIVOT

The drive wheel pivot is located directly above the drive wheel. Lubricate the drive wheel pivot after every 200 hours.

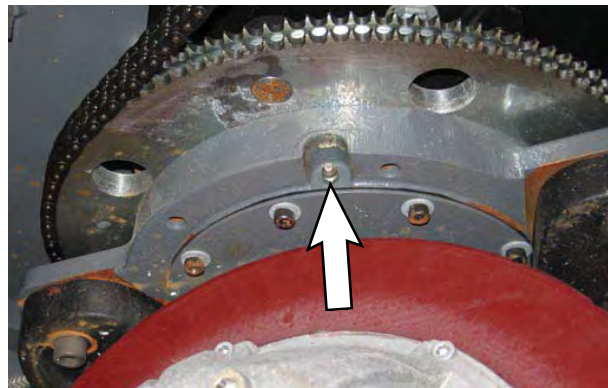

HOPPER CHAINS

The hopper chains are located on the left hand side of the machine. Check for damage or wear and lubricate the hopper chains after every 200 hours..

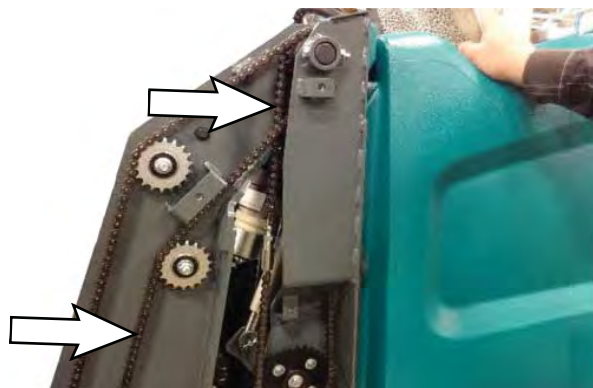

MAINTENANCE

HOPPER LIFT ARM PIVOTS

Lubricate the hopper lift arm pivots after every 200 hours of operation.

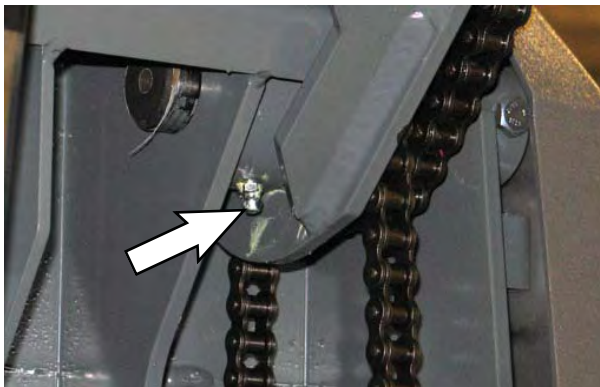
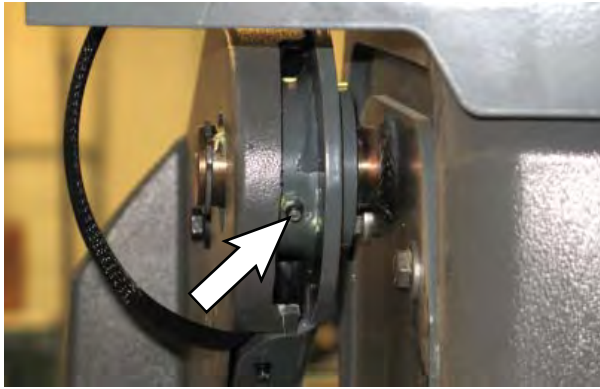

HOPPER CHAINS

The hopper chains are located on the left hand side of the machine. Check the tension of the hopper chains after the first 50 hours of operation then every 500 hours after that.

With the hopper in the lowered position; the longer arm chain (A) should not move more than 25 mm (1 in) and the shorter lintel chain (B) should not move more than 12 mm (0.5 in).

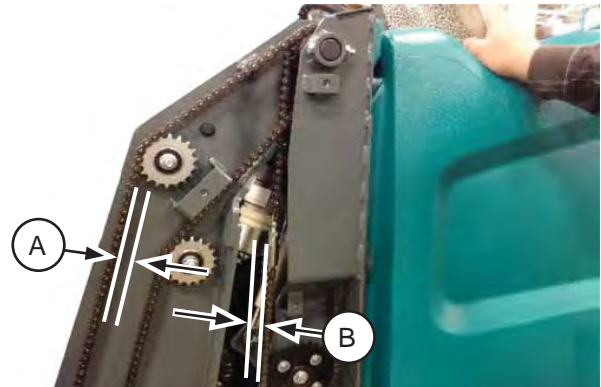

HYDRAULICS

Check the hydraulic fluid level at operating temperature daily. The hydraulic fluid level should be between the MIN and MAX markings on the hydraulic reservoir. The hopper must be down when checking hydraulic fluid level.

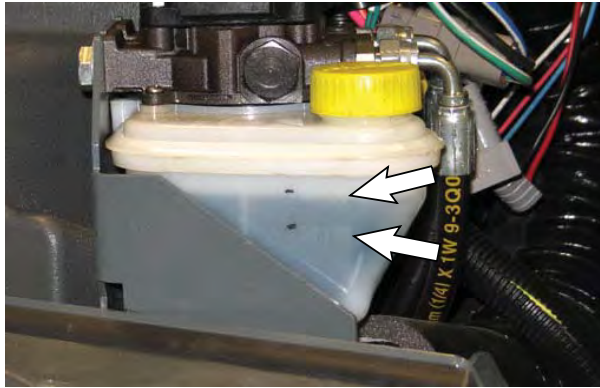

ATTENTION! Do not overfill the hydraulic fluid reservoir or operate the machine with a low level of hydraulic fluid in the reservoir. Damage to the machine hydraulic system may result.

Drain and refill the hydraulic fluid reservoir with new **Tennant True** premium hydraulic fluid after every 2400 hours of operation.

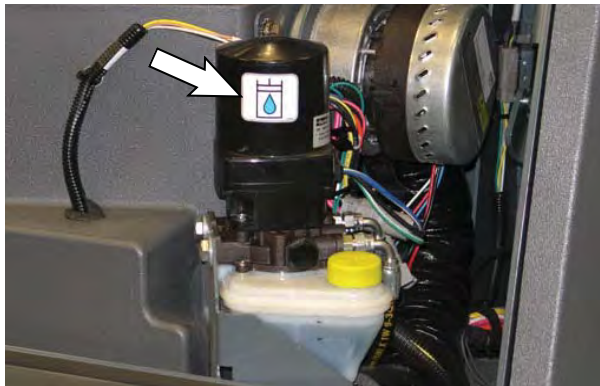

HYDRAULIC FLUID

Tennant <i>True</i> premium hydraulic fluid (Extended Life)		
Part Number	Capacity	ISO Grade Viscosity Index (VI)
1057707	3.8 L (1 gal)	ISO 32 VI 163 or higher
1057708	19 L (5 gal)	

If using a locally-available hydraulic fluid, be sure the specifications match Tennant hydraulic fluid specifications. Substitute fluids can cause premature failure of hydraulic components.

ATTENTION! Hydraulic components depend on system hydraulic fluid for internal lubrication. Malfunctions, accelerated wear, and damage will result if dirt or other contaminants enter the hydraulic system.

HYDRAULIC HOSES

Check the hydraulic hoses after every 800 hours of operation for wear or damage.

FOR SAFETY: When servicing machine, use cardboard to locate leaking hydraulic fluid under pressure.

High pressure fluid escaping from a very small hole can almost be invisible, and can cause serious injuries.

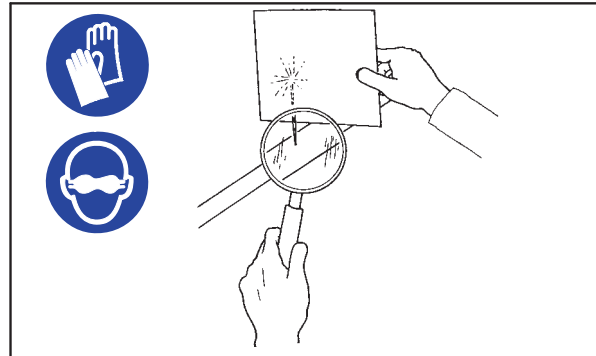

00002

Consult a physician immediately if injury results from escaping hydraulic fluid. Serious infection or reaction can occur if proper medical treatment is not given immediately.

Contact a mechanic or supervisor if a leak is discovered.

BATTERY



FOR SAFETY: Before leaving or servicing machine, stop on level surface, turn off machine, set parking brake (if equipped), and remove key.

The lifetime of the battery depends on proper maintenance. To get the most life from the battery:

- Do not leave the battery partially discharged for long period of time.
- Only charge the battery in a well ventilated area to prevent gas build up. Charge batteries in areas with ambient temperatures 27°C (80°F) or less.
- Maintain the proper electrolyte levels of the flooded (wet) battery by checking levels weekly.

The following steps do not apply if Opportunity charging (See *OPPORTUNITY CHARGING* section).

- Do not charge the battery more than once a day and only after running the machine for a minimum of 15 minutes.
- Allow the charger to completely charge the battery before reusing the machine.

CHECKING THE ELECTROLYTE LEVEL

The flooded (wet) lead-acid battery requires routine maintenance as described below. Check the battery electrolyte level weekly.

NOTE: Do Not check the electrolyte level if the machine is equipped with the battery watering system. Proceed to the BATTERY WATERING SYSTEM (OPTION).

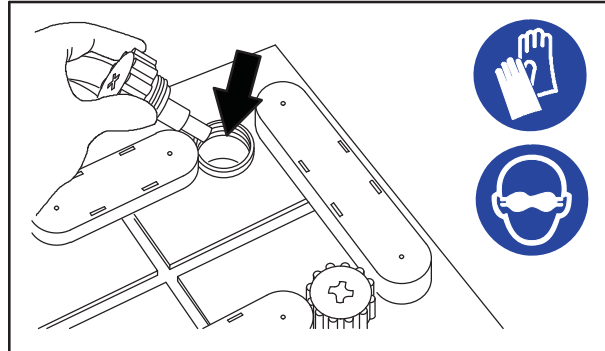

08247

FOR SAFETY: When servicing machine, keep all metal objects off batteries. Avoid contact with battery acid.

The level should be slightly above the battery plates as shown before charging. Add distilled water if low. **DO NOT OVERFILL.** The electrolyte will expand and may overflow when charging. After charging, distilled water can be added up to about 3 mm (0.12 in) below the sight tubes.

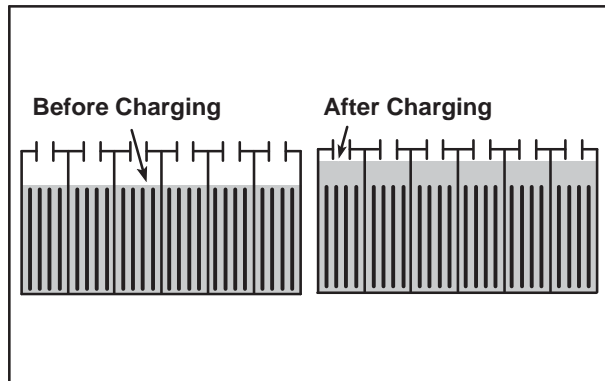

NOTE: Make sure the battery caps are in place while charging. There may be a sulfur smell after charging batteries. This is normal.

MAINTENANCE-FREE BATTERIES

Maintenance-free batteries do not require watering. Cleaning and other routine maintenance is still required.

CHECKING CONNECTIONS / CLEANING

After every 200 hours of use check for loose battery connections and clean the surface of the batteries, including terminals and cable clamps, with a strong solution of baking soda and water. Replace any worn or damaged wires. Do not remove battery caps when cleaning batteries.

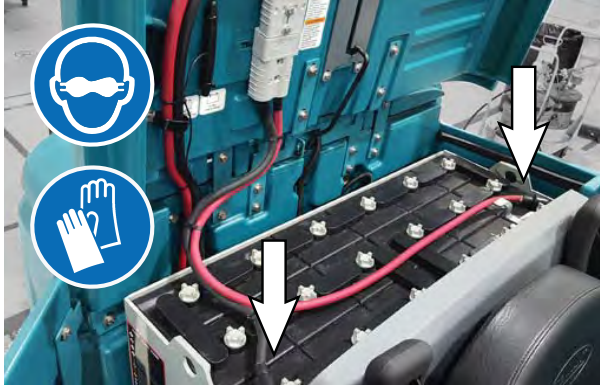

CHARGING THE BATTERY

IMPORTANT: Before charging, make sure that the machine and charger settings are properly set for the battery type.

NOTE: Use a charger with the proper rating for the batteries to prevent damage to the batteries or reduce the battery life.

NOTE: Do not opportunity charge standard batteries since doing so can shorten battery life.

1. Drive the machine to a flat, dry surface in a well-ventilated area.
2. Stop the machine and turn off the machine power.

FOR SAFETY: Before leaving or servicing machine, stop on level surface, turn off machine, set parking brake, and remove key.

3. Lift the battery compartment top cover open and engage the support.

NOTE: Make sure the batteries have the proper electrolyte level before charging. See **CHECKING THE ELECTROLYTE LEVEL**.

4. Plug the charger AC power supply cord into a properly grounded outlet.
5. Disconnect the battery cable from the machine connector.

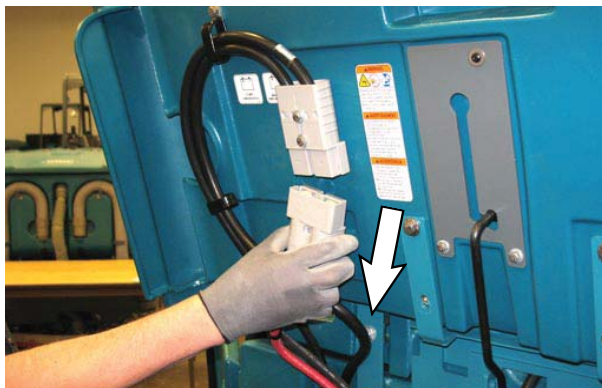

6. Connect the charger connector to the battery cable.

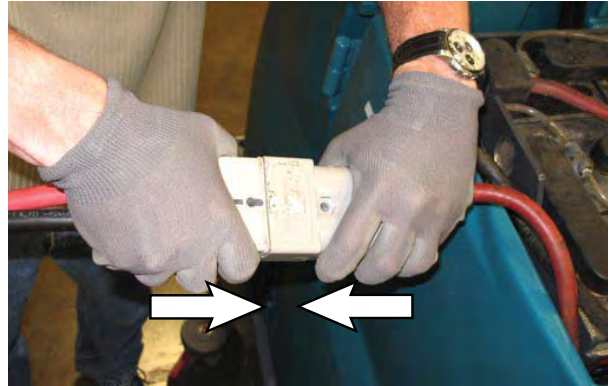

TO CHARGE WITH TENNANT BRANDED CHARGER

1. Turn on the battery charger if required.

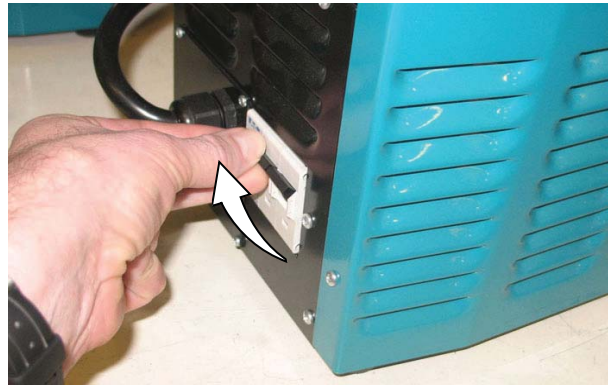

WARNING: Batteries emit hydrogen gas. Explosion or fire can result. Keep sparks and open flame away. Keep covers open when charging.

NOTE: If there are charger fault codes when the battery is plugged into the battery charger, the fault codes will appear at the bottom of the charger display. Refer to the battery charger manual for fault code definitions



MAINTENANCE

- Observe the charger display. CHARGE appears on the display when the battery is charging. This is the charger default screen.



Charger Display:

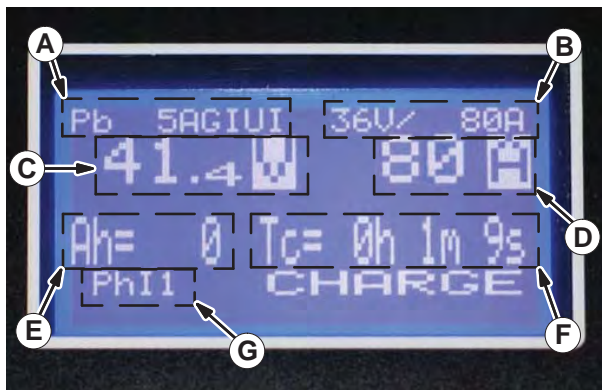

- C. Charge profile number
- D. Charger rating (Volts and Current)
- E. Battery voltage (Volts)
- F. Charger current (Amperes)
- G. Ampere hours charged
- H. Time charged (hours / minutes / seconds)
- I. Charging phase (Phase 1 / Phase 2 / Phase 3 / Maintenance)

- If necessary, press the navigation buttons to access additional screens. Press the charger stop / start / enter button to enter selection. The charger will return to the default screen. Refer to manufacturers operator manual for additional information.



NOTE: If the charger cable must be disconnected from the battery before they are fully charged, press the charger stop / start / enter button to stop charging. Be sure STOP appears on the display and the red stop charge light is illuminated before disconnecting the battery charger cable.

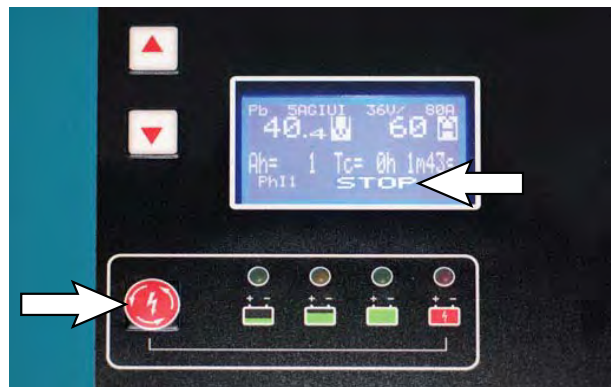

- The charger status indicators will illuminate from left to the right as the battery is charging. COMPLETE will appear in the display, all the charger status indicators will be illuminated, and the Tennant charger will stop charging when the battery is completely charged.

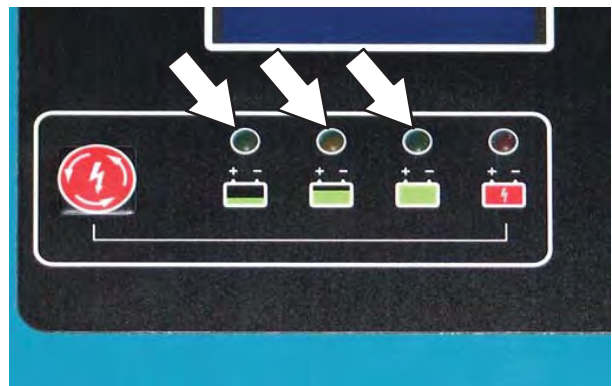

- After the batteries have completely charged, disconnect the charger connector from the battery cable connector.

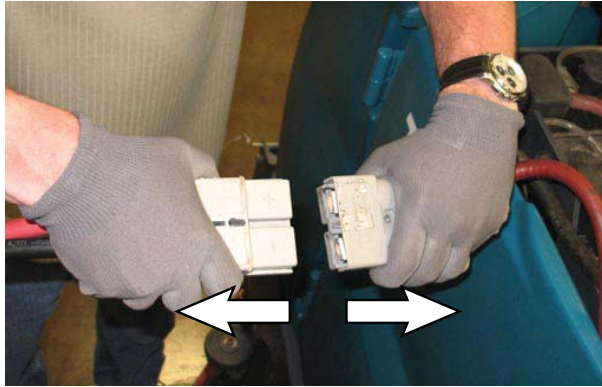

- Reconnect the battery connector to the machine connector.

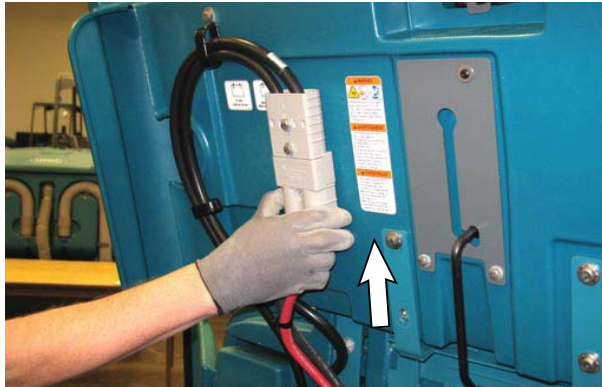

FOR SAFETY: When servicing machine do not disconnect the off-board charger's DC cord from the machine receptacle when the charger is operating. Arcing may result. If the charger must be interrupted during charging, disconnect the AC power supply cord first.

- Close the battery compartment top cover.

TO CHARGE WITH ENERSYS BATTERY CHARGER

- Turn on battery charger if required.



WARNING: Batteries emit hydrogen gas. Explosion or fire can result. Keep sparks and open flame away. Keep covers open when charging.

NOTE: If there are charger fault codes when the battery is plugged into the battery charger, the fault codes will appear on the charger display. Refer to the battery charger manual for fault code definitions.



- Observe the charger display. The charging indicator will illuminate on the display when the battery is charging. This is the charger default screen.



Charger Display:

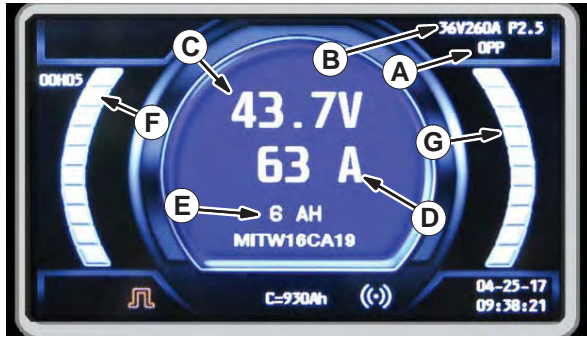

- A. Charge profile number
 - C. Charger rating (Volts and current)
 - D. Battery voltage (Volts)
 - E. Charger current (Ampres)
 - F. Ampere hours charged
 - G. Time charged
 - H. Percent of charge
9. If necessary, press the navigation buttons to access additional screens. Press the charger stop/start/enter button to enter the selection. The charger will return to the default screen. Refer to manufacture's operator manual for additional information.



NOTE: If the charger cable must be disconnected from the battery before they are fully charged, press the charger stop / start / enter button to stop charging. Be sure the charging indicator is no longer illuminated before disconnecting the battery charger cable.

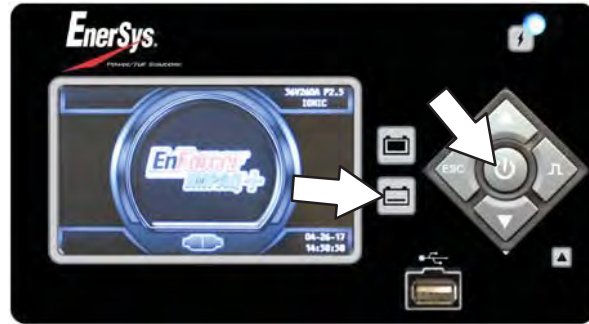

10. The yellow charging indicator will illuminate while the battery is charging. Once the charging is complete the yellow charging indicator light will go out and the green charge complete indicator will be illuminated. The charger will stop charging when the battery is completely charged.



11. After the batteries have completely charged, disconnect the charger connector from the battery cable connector.

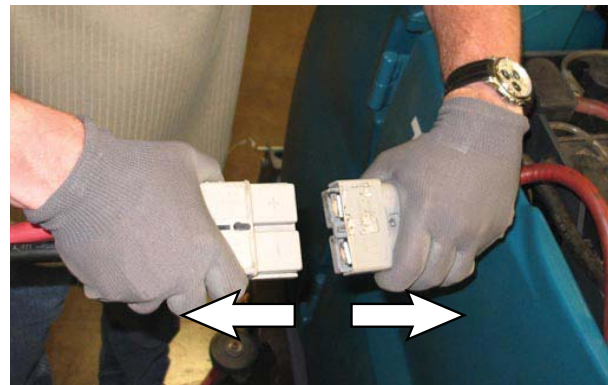

12. Reconnect the battery connector to the machine connector.

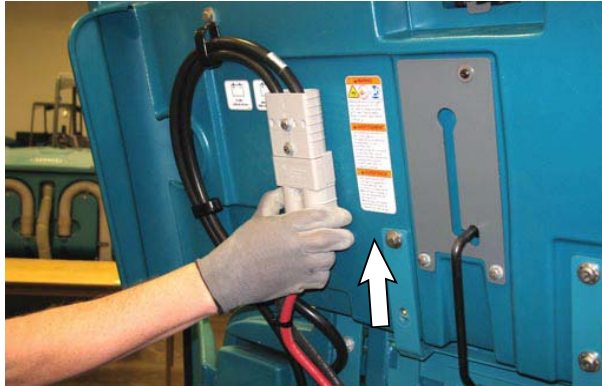

FOR SAFETY: When servicing machine do not disconnect the off-board charger's DC cord from the machine receptacle when the charger is operating. Arcing may result. If the charger must be interrupted during charging, disconnect the AC power supply cord first.

13. Close the battery compartment top cover.

FOR SAFETY: Before leaving or servicing machine, stop on level surface, turn off machine, set parking brake, and remove key.

BATTERY CHARGER USB PORT

The battery charger USB port is for maintenance computer access to the charger by authorized service personnel only. **Do Not** plug cell phones or other unauthorized electronic devices into the battery charger USB port. **Do Not** plug anything into the USB port while the battery is charging.

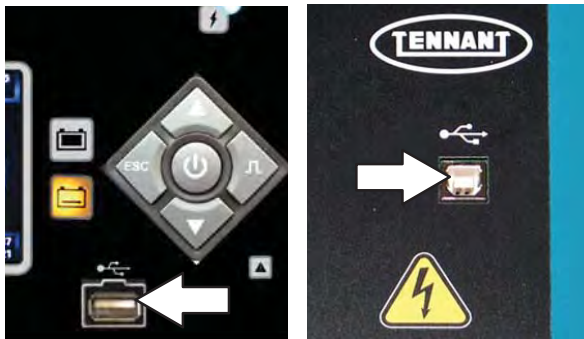

OPPORTUNITY CHARGING (OPTION)

Opportunity charging is used to extend machine run time and productivity by allowing batteries to be charged during breaks, lunch, between shifts, or whenever there is an "opportunity" to charge.

IMPORTANT: Before charging, make sure that the machine and charger settings are properly set for the battery type.

NOTE: The machine must be equipped with a battery capable of being opportunity charged. Do not opportunity charge standard batteries since doing so can shorten battery life.

1. Drive the machine to a flat, dry surface in a well-ventilated area.
2. Stop the machine and turn off the machine power.

FOR SAFETY: Before leaving or servicing machine, stop on level surface, turn off machine, set parking brake, and remove key.

3. Lift the battery compartment top cover open and engage the support.

NOTE: Make sure the batteries have the proper electrolyte level before charging. See CHECKING THE ELECTROLYTE LEVEL.

4. Disconnect the battery cable from the machine connector.

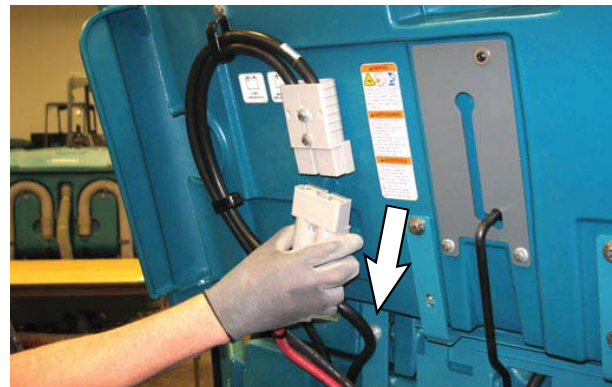

MAINTENANCE

5. Connect the charger connector to the battery cable.

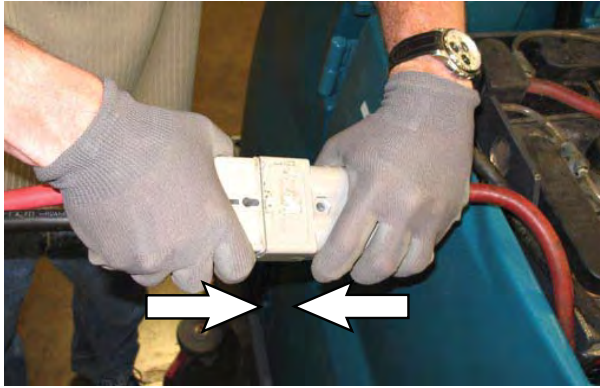

6. The battery will be opportunity charged during the break.
7. When ready to start using the machine again press the charger stop / start button to stop the charger.



FOR SAFETY: When servicing machine do not disconnect the off-board charger's DC cord from the machine receptacle when the charger is operating. Arcing may result. If the charger must be interrupted during charging, press charger stop / start button to stop charger.

8. Disconnect the charger connector from the battery cable connector.

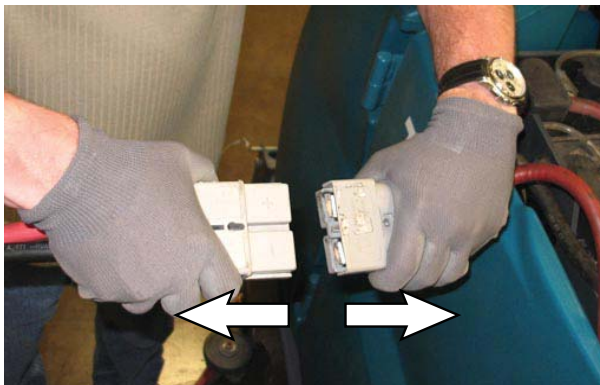

9. Reconnect the battery connector to the machine connector.



10. Close the battery compartment top cover.

WEEKLY EQUALIZATION CHARGE

The opportunity charger is programmed to automatically provide a full equalization charge at a designated weekly interval.

IMPORTANT: The weekly equalization charge must be completed in its entirety. If it is interrupted during charging, it must be allowed to complete the equalization charge the next time it is started or it could damage the battery or severely shorten the battery life.

NOTE: Sunday is the default day for the charger to conduct a full equalization charge to the battery. The default day can be changed to another day if necessary. Consult a Tennant service representative about changing the default day.

Allow the charger to fully complete the equalization charge. The yellow charging indicator will be illuminated and the charging status will be displayed in the graphic display.

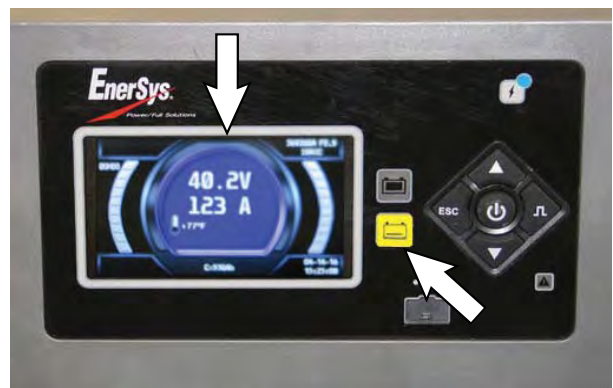

The yellow charging indicator will go out and the green charge complete indicator will be illuminated when the battery equalization charge is complete.



BATTERY WATERING SYSTEM (OPTION)

The optional battery watering system provides a safe and easy way to maintain the proper electrolyte levels in the batteries.

Check the battery watering system hoses and connections for damage or wear after every 100 hours.

FOR SAFETY: Before leaving or servicing machine, stop on level surface, turn off machine, set parking brake, and remove key.

1. Lift the battery compartment cover open and engage the support.

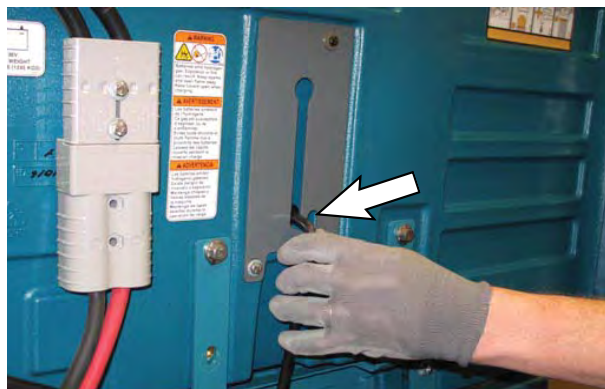

2. Fully charge batteries prior to using the battery watering system. Do not add water to batteries before charging, the electrolyte level will expand and may overflow when charging. See CHARGING THE BATTERIES.
3. Connect the battery watering system hose to the water supply source.

NOTE: Water quality is important to maintain the life of the battery. Always use water that meets battery manufacturer requirements.

NOTE: The water supply to the battery water system must always be 7.57 LPM (2 GPM) or more. Use the purger to confirm the water supply pressure. Refer to manufacturer Operator Manual for additional information.

4. Connect the battery watering system hose to the battery fill hose.

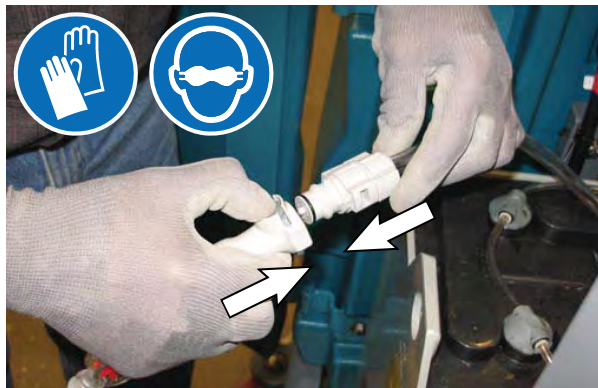

5. Turn on the water supply. The indicator inside the flow indicator will spin. The indicator stops spinning when the batteries are full.

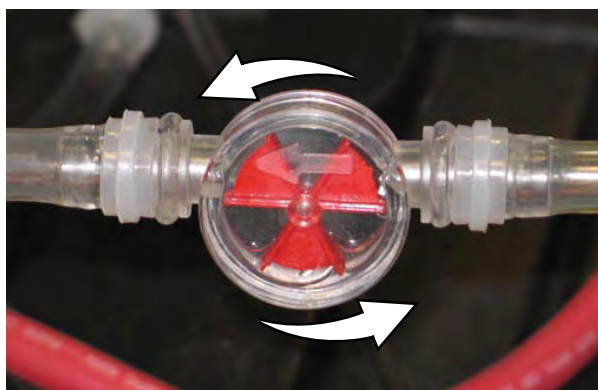

6. Disconnect the battery watering system hose from the water supply hose.
7. Turn off the water supply.
8. After adding water, return the battery watering system hose to the storage location for future use.

CIRCUIT BREAKERS, FUSES, AND RELAYS

CIRCUIT BREAKERS

Circuit breakers are resettable electrical circuit protection devices designed to stop the flow of current in the event of a circuit overload. Once a circuit breaker is tripped, reset it manually by pressing the reset button after the breaker has cooled down.

Circuit breakers 1 through 9 are located under the operator seat behind the battery compartment side cover.



Circuit breakers 10 through 15 are located behind the steering shroud access panel.

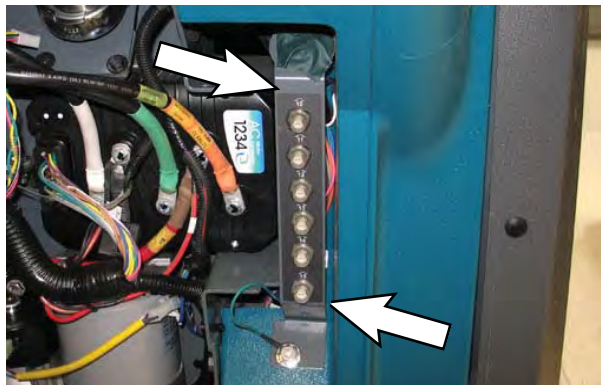

Circuit breakers 16 through 20 are located in the hopper compartment.

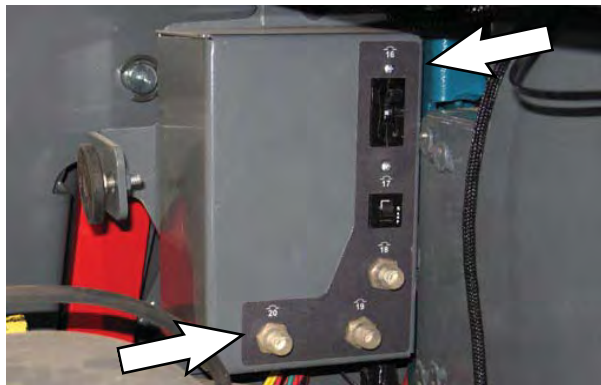

Circuit breaker 21 is located inside the optional light assembly mounted on top of the recovery tank.

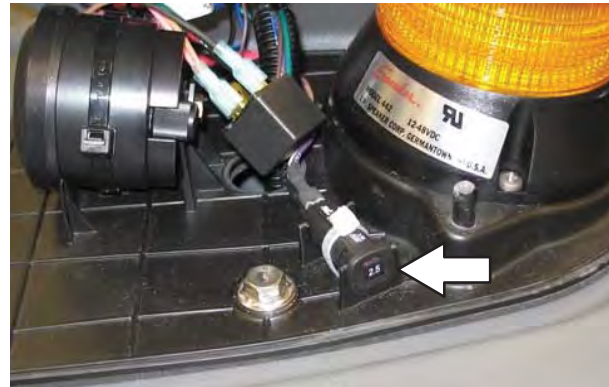

If the overload that caused the circuit breaker to trip is still present, the circuit breaker will continue to stop current flow until the problem is corrected.

The chart below shows the circuit breakers and the electrical components they protect.

Circuit Breaker	Rating	Circuit Protected
CB1	60A	Water pickup module
CB2	-	Not used
CB3	35A	Side brush scrub module (Option)
CB4	2.5A	Key switch
CB5	2.5A	Water pick up module
CB6	2.5A	Scrub module
CB7	2.5A	Side brush scrub module (Option)
CB8	2.5A	ec-H2O power module (Option)
CB9	2.5A	ec-H2O pump module (Option)
CB10	15A	Spray nozzle (Option)
CB11	15A	Lights (Option)
CB12	2.5A	Lights (Option)
CB13	2.5A	Strobe light / Flashing light on overhead guard (Option)
CB14	2.5A	Strobe light / Flashing light on recovery tank (Option)
CB15	30A	Power steering (Option)
CB16	60A	Lift module
CB17	15A	Sweep module
CB18	40A	Sweep vacuum 1
CB19	40A	Sweep vacuum 2
CB20	40A	Dry vacuum (Option)
CB21	2.5A	Alarm / Flashing light (Option)

MAINTENANCE

FUSES

Fuses are one-time protection devices designed to stop the flow of current in the event of a circuit overload. Never substitute higher value fuses than specified.

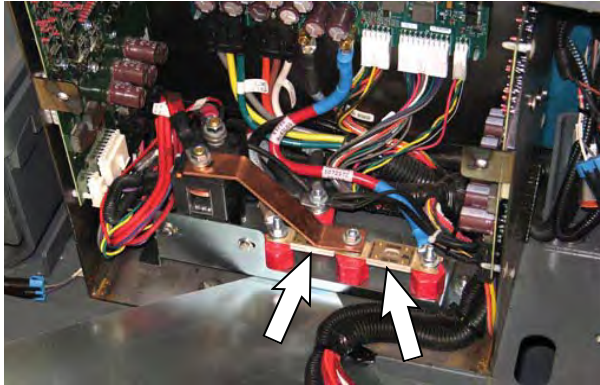

The fuses are located in the control box behind the circuit breaker panel or inline on harnesses and cables.

Fuse	Rating	Circuit Protected
Fuse-1	150A	Propelling
Fuse-2	100A	Scrub module power
Fuse-3	2A	Telemetry (inline, Option)
Fuse-4	150A	Sweep (inline)

RELAYS

Relays are electrical switches that open and close under the control of another electrical circuit. Relays are able to control an output circuit of higher power than the input circuit. The relays are located in the control box behind the circuit breaker panel.

Refer to the table below for the relays and circuits controlled.

Relay	Rating	Circuit Controlled
M1	36 VDC, 200 A	Main contactor
M2	36 VDC, 5 A	Backup alarm / light (Option)
M3	36 VDC, 100 A	Auxiliary line contactor
M4	36 VDC, 200A	Sweep contactor

ELECTRIC MOTORS

Inspect the carbon brushes on the scrubbing vacuum fan motors after every 500 hours of operation. Inspect the carbon brushes on the scrubbing side brush motors after the first 1000 hours of operation and every 100 hours after the initial check. Refer to the table below for carbon brush inspection intervals.

Carbon Brush Inspection	Hours
Side brush motors - Sweeping (Option)	1000*
Scrubbing vacuum fan motor	500

**Inspect carbon brushes every 100 hours after the initial 1000 hour change.*

SOLUTION SUPPLY FILTER

Check the solution supply filter screen after every 50 hours of operation and clean if necessary. Lower the scrub head for easier access.

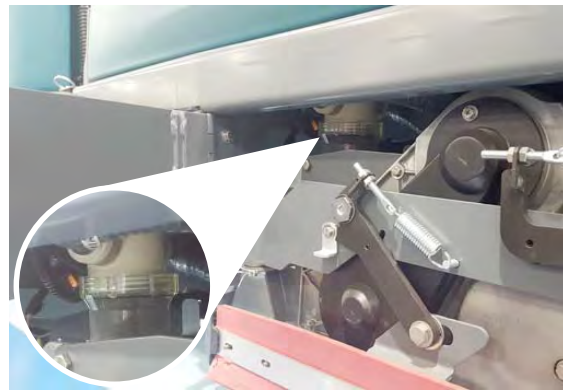

HOPPER DUST FILTER / PERMA-FILTER

FOR SAFETY: Before leaving or servicing machine, stop on level surface, set parking brake, turn off machine, and remove key.

REMOVING / REPLACING THE HOPPER DUST FILTER

Shake the dust filter at the end of every shift and before removing the filter from the machine. Inspect and clean the filter after every 100 hours of operation. Replace damaged dust filters.

NOTE: Clean the filter more often if used in extremely dusty conditions.

1. Remove the hopper cover from the hopper.



2. Remove the dust filter cover.



3. Remove the dust filter from the hopper.



4. Clean or discard the dust filter element. Refer to *CLEANING THE DUST FILTER*.
5. Clean dust and debris from the dust filter tray.

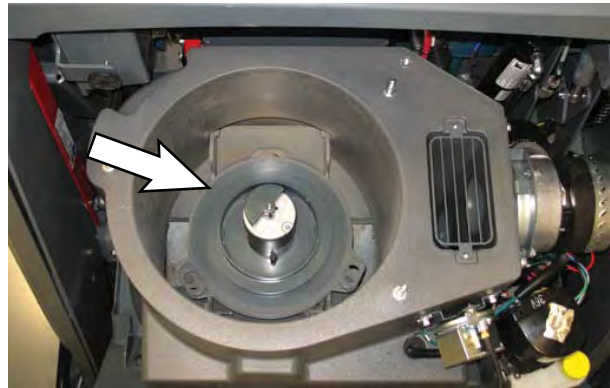

6. Reinstall the dust filter.
7. Reinstall the dust filter cover.
8. Reinstall the hopper cover.

MAINTENANCE

CLEANING THE HOPPER DUST FILTER

Use one of the following methods to clean the dust filter:

SHAKING-Press the *filter shaker switch*.

TAPPING-Tap the filter gently on a flat surface.
Do not damage the edges of the filter. The filter will not seal properly if the edges of the filter are damaged.



AIR-Always wear eye protection when using compressed air. Blow air through the center of the filter and out toward the exterior. Never use more than 550 kPa (80 psi) of air pressure with a nozzle no smaller than 3 mm (0.13 in) and never hold the nozzle closer than 50 mm (2 in) to the filter.



THERMO-SENTRY

The Thermo-Sentry, located inside the hopper, senses the temperature of the air pulled up from the hopper. If there is a fire in the hopper, the Thermo-Sentry stops the vacuum fan and cuts off the air flow. The Thermo-Sentry automatically resets after cooling down.

INSPECTING / CLEANING THE PERMA-FILTER

Inspect and clean the Perma-Filter after every 100 hours of operation.

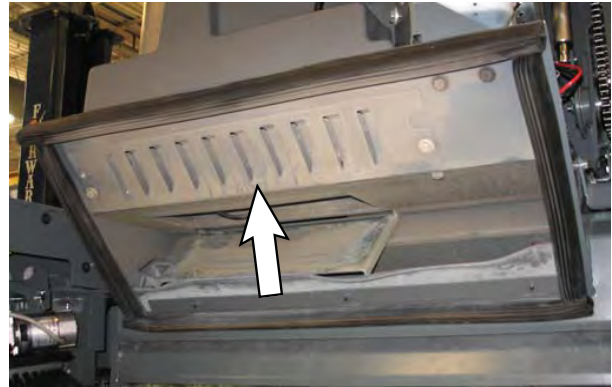

MAIN SCRUB BRUSHES

The machine can be equipped with either disk or cylindrical scrub brushes. Check scrub brushes daily for wire or string tangled around the brush or brush drive hub. Also check brushes or pads for damage and wear.

DISK BRUSHES AND PADS

Replace the pads when they no longer clean effectively. Replace the brushes when they no longer clean effectively or when the bristles are worn to the yellow indicator.

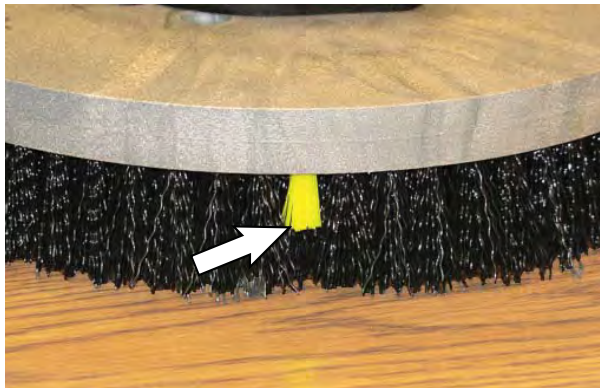

Cleaning pads must be placed on pad drivers before they are ready to use. The cleaning pad is held in place with a center disk. Both sides of the pad can be used for scrubbing. Turn the pad over to use the other side.

Cleaning pads need to be cleaned immediately after use with soap and water. Do not wash the pads with a pressure washer. Hang pads, or lay pads flat to dry.

NOTE: Always replace brushes and pads in sets. Otherwise one brush or pad will be more aggressive than the other.

REPLACING DISK SCRUB BRUSHES OR PAD DRIVERS

1. Raise the scrub head.
2. Turn off the machine.

FOR SAFETY: Before leaving or servicing machine, stop on level surface, turn off machine, set parking brake, and remove key.

3. Open the main brush access door and side squeegee support door.



4. Turn the brush until the spring handles are visible.

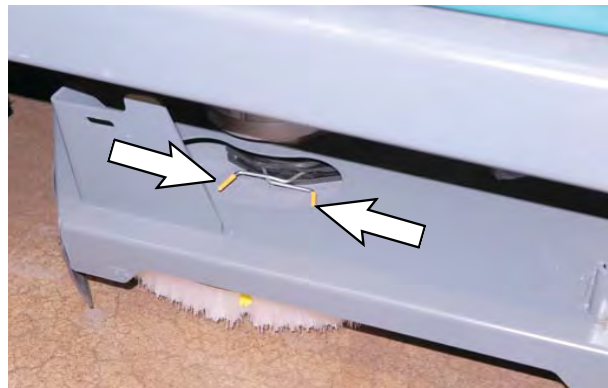

5. Squeeze the spring handles and let the brush drop to the floor. Remove the brush from under the scrub head.



6. Set the brush spring open on the new brush to make installation easier.



7. Push the new brush under the scrub head, align the brush drive socket with the brush drive hub, and lift the brush up onto the brush drive hub until the brush locks onto the hub.



8. Ensure the brush is securely mounted on the brush drive hub.
9. Close and secure the squeegee support door and close the main brush access door.
10. Repeat procedure for the other brushes.

REPLACING DISK SCRUB PADS

1. Remove the pad driver from the machine.
2. Squeeze the spring clip together and remove the center disk from the pad driver.



3. Remove the scrub pad from the pad driver.



4. Flip or replace the scrub pad. Center the scrub pad on the pad driver and reinstall the center disk to secure the pad in place on the pad driver.
5. Reinstall the pad driver onto the machine.

CYLINDRICAL SCRUB BRUSHES

Rotate the brushes from front-to-rear after every 50 hours of operation.

Replace the brushes when they no longer clean effectively.

NOTE: Replace worn brushes in pairs. Scrubbing with brushes of unequal bristle length will result in diminished scrubbing performance.

REPLACING CYLINDRICAL SCRUB BRUSHES

FOR SAFETY: Before leaving or servicing machine, stop on level surface, turn off machine, set parking brake, and remove key.

1. Open the main brush access door and side squeegee support door.

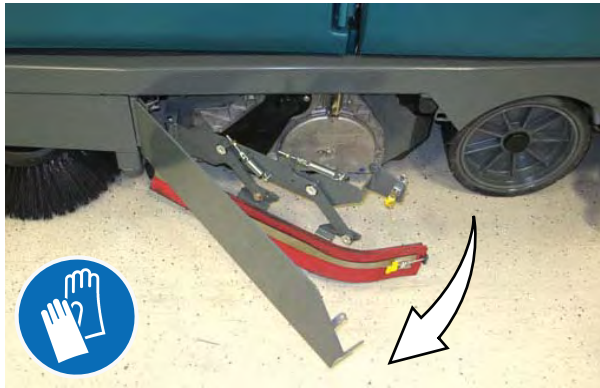

2. Lift the idler plate retainer handle and unhook the retainer ring from the idler plate hook.

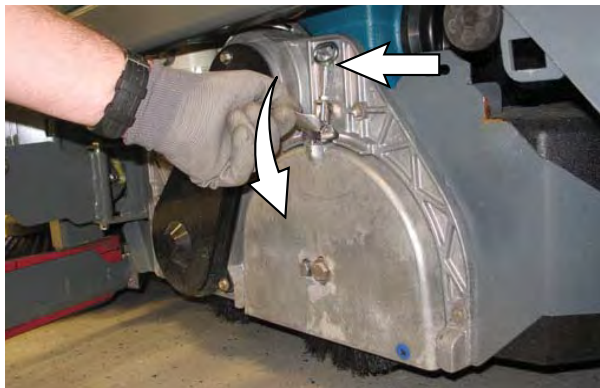

3. Remove the idler plate from the scrub head.



4. Remove the brush from the scrub head.



5. Position the brush with the *double row end* towards the scrub head opening. Guide the new brush onto the drive hub.
6. If rotating the brushes, always rotate the front with the back so that they wear evenly. They may be rotated end for end as well.

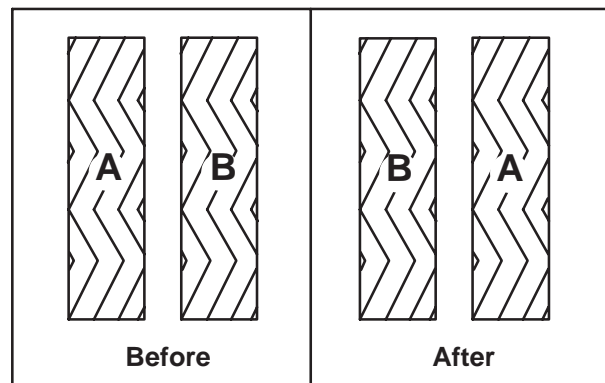

7. Slide the idler plate up into the scrub head.



8. Secure the idler plate into place with the idler plate retainer.



NOTE: Do not switch the left or right idler plates or the brushes will need to be readjusted by trained personnel.

9. Close and secure the squeegee support door and close the main brush access door.
10. Repeat for the brush on the other side of the scrub head.

MAIN SWEEP BRUSHES

Check the brush daily for wear or damage. Remove any string or wire tangled on the main brush, main brush drive hub, or main brush idler hub.



Rotate the brush end-for-end after every 50 hours of operation, for maximum brush life and best sweeping performance. Refer to REPLACING OR ROTATING THE MAIN BRUSH.

Replace the brushes when they no longer clean effectively.

REPLACING THE MAIN SWEEPING BRUSH

1. Raise the sweeping main brush and turn off the machine.

FOR SAFETY: Before leaving or servicing machine, stop on level surface, turn off machine, set parking brake, and remove key.

2. Open the main sweeping brush compartment access door.



3. Remove the knob and the main sweep brushes idler plate.



4. Pull the brushes from the main sweep compartment.



5. Replace or rotate the main brushes end-for-end.
6. Slide the brushes into the main sweep brush compartment and all the way onto the drive hubs.
7. Reinstall the main sweep brushes idler plate.
8. Close the main sweeping brush compartment access door.

SIDE BRUSH(ES)

Check the side brush(es) daily for wear or damage. Remove any tangled string or wire from the side brush(es) or side brush drive hubs.

REPLACING THE SWEEPING SIDE BRUSHES

Replace the brushes when they no longer clean effectively.

1. Raise the side brush assembly and turn off the machine.

FOR SAFETY: Before leaving or servicing machine, stop on level surface, turn off machine, set parking brake, and remove key.

2. Reach into the center of the brush and remove the cotter pin and washer holding the brush and the retainer to the hub.



3. Remove the side brush and retainer from under the side brush assembly.



4. Place the side brush underneath the side brush assembly and align the channel in the retainer with the retainer pin in the side brush hub.

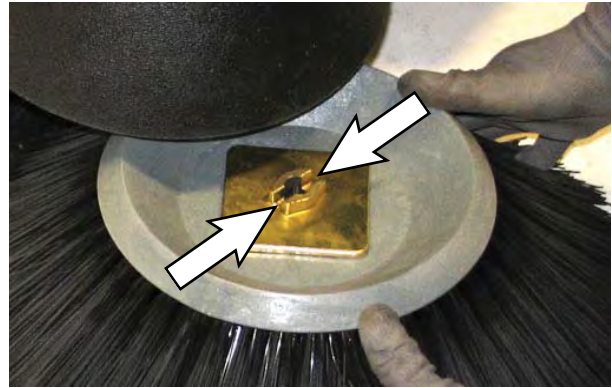

5. Lift the side brush, retainer, and washer up onto the side brush hub and reinstall the cotter pin into the hub.

ADJUSTING THE SWEEPING SIDE BRUSHES

Check the side brush pattern after every 50 hours of operation. The right side brush bristles should touch the floor between 10 o'clock and 3 o'clock and the left side brush bristles should touch the floor between 9 o'clock and 2 o'clock when the brushes are in motion.

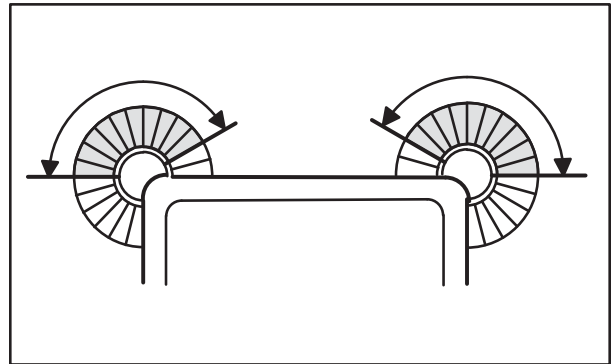

350327

TO ADJUST SWEEPING SIDE BRUSH - STANDARD PANEL

1. Turn on the machine.
2. Press and hold the *sweeping side brush button* until the side brush height adjustment screen appears in the LCD display.



NOTE: The Contrast Control and Configuration Mode buttons are used for selecting and adjusting the side brush height.

3. Press the desired sweeping side brush button to select it. The selected side brush will lower and spin.

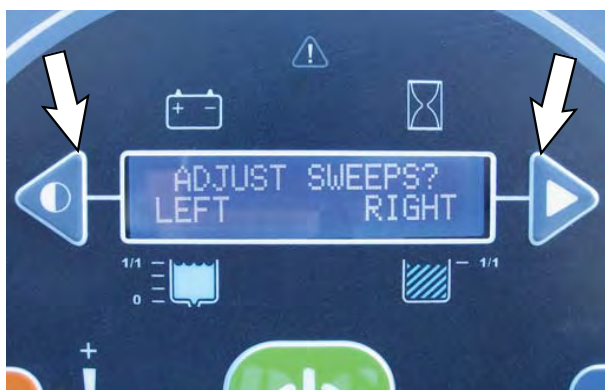

4. Observe the brush pattern

5. Press the left (-) button to raise the brush or the right (+) button to lower it to obtain the correct brush pattern. The indicator bars increase as the brush gets lower.

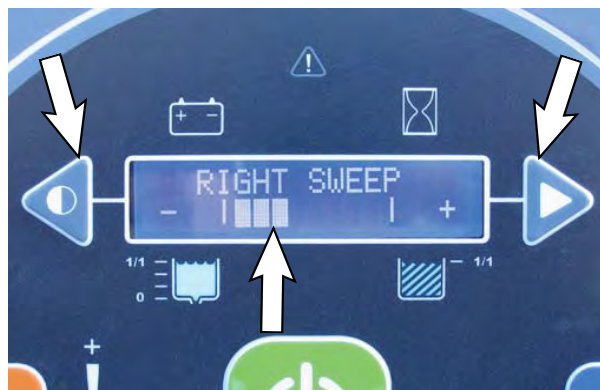

6. Press the *sweeping side brush button* to save the setting and return to the side brush adjustment text prompt.
7. Repeat previous instructions to adjust the other sweeping side brush.
8. Recheck the brush patterns. Adjust brush height as necessary.

NOTE: Contact a Tennant service representative if there is a flat pattern (full circle) after the sweeping side brushes have been adjusted.

MAINTENANCE

TO ADJUST SWEEPING SIDE BRUSH - PRO-PANEL

1. Turn on the machine.
2. Press and hold the *sweeping side brush button* until the side brush height adjustment screen appears in the display.



3. Press the yes button.

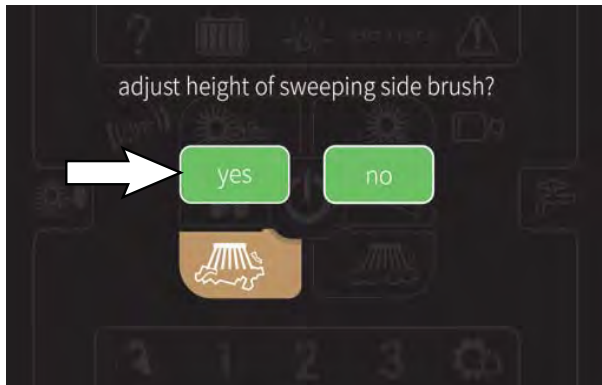

4. Press the desired sweeping side brush button to adjust it. The selected brush will lower and spin.



5. Observe the brush pattern.
6. Press the up button to raise the brush or the down button to lower it to obtain the correct brush pattern. The indicator moves up / down to show the change in brush height.

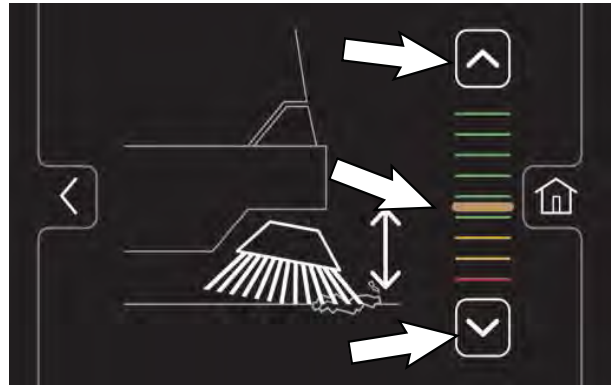

- Press the home button to save the setting and navigate back to the main operating screen.

- Press the back button to navigate back to the previous screen.

7. Press the *back button* to return to the "select side to adjust" screen.
8. Repeat previous instructions to adjust the other sweeping side brush.
9. Recheck the brush patterns. Adjust brush pressure as necessary.

NOTE: Contact a Tennant service representative if there is a flat pattern (full circle) after the sweeping side brushes have been adjusted.

REPLACING THE SCRUBBING SIDE BRUSH (OPTION)

Replace the pads when they no longer clean effectively. Replace the brushes when they no longer clean effectively or when the bristles are worn down to the yellow indicators.

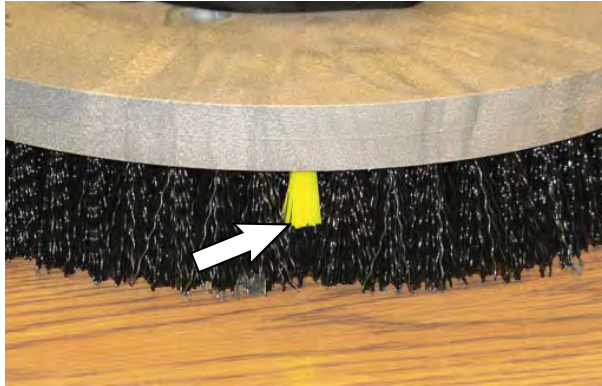

1. Raise the side brush assembly and turn off the machine.

FOR SAFETY: Before leaving or servicing machine, stop on level surface, turn off machine, set parking brake, and remove key.

2. If necessary, remove the scrubbing side brush squeegee assembly to make access to the scrubbing side brush easier.



3. Squeeze the spring handles and let the side brush drop to the floor.



4. Remove the side brush from under the side brush assembly.



5. Set the brush spring open on the new brush to make installation easier.



6. Place the new side brush underneath the side brush assembly and lift the side brush up onto the side brush hub until the brush locks onto the hub.
7. Reinstall the scrubbing side brush squeegee assembly.

SQUEEGEE BLADES

Check the squeegee blades for damage and wear daily. When the blades become worn, rotate the blades end-for-end or top-to-bottom to a new wiping edge. Replace blades when all edges are worn.

Check the deflection of the squeegee blades daily or when scrubbing a different type of surface. Check the leveling of the rear squeegee every 50 hours of operation.

REPLACING (OR ROTATING) THE REAR SQUEEGEE BLADES

1. If necessary, lower the *rear bumper door / step*.

FOR SAFETY: Before leaving or servicing machine, stop on level surface, turn off machine, set parking brake, and remove key.

2. Disconnect the vacuum hose from the rear squeegee assembly

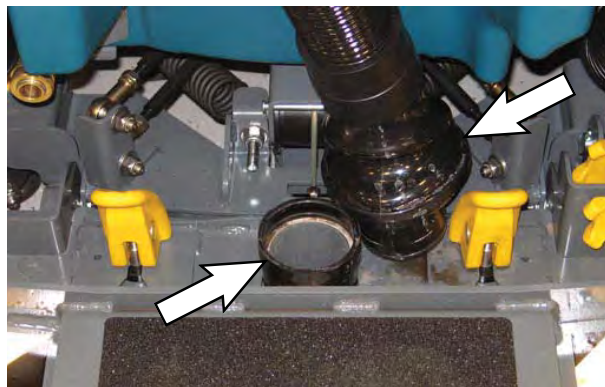

3. Loosen both squeegee mounting handles.

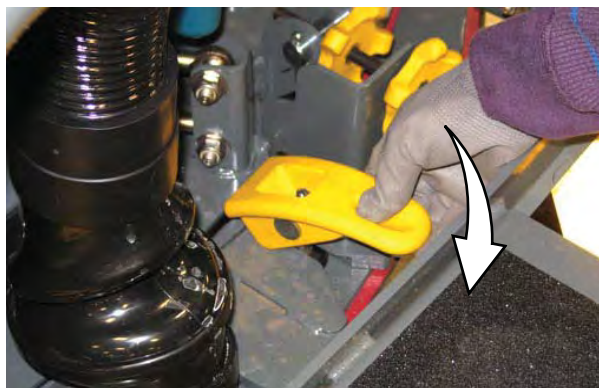

4. Pull the rear squeegee assembly from the machine.



5. Loosen the rear retainer latch and remove the latch and the retainer from the squeegee assembly.

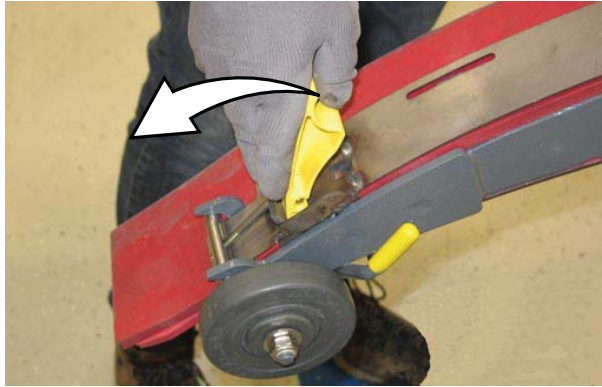

6. Remove the rear squeegee from the squeegee assembly.

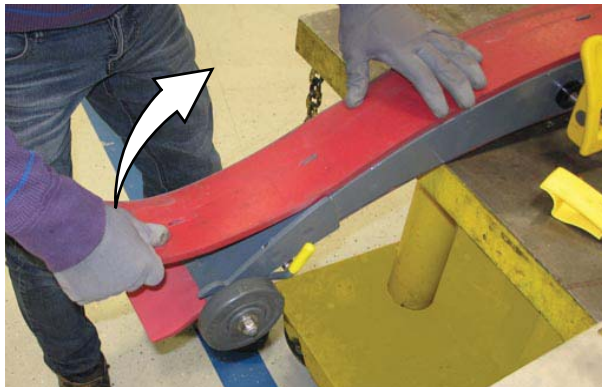

7. Place the rotated or new squeegee blade onto the rear squeegee assembly. Be sure the squeegee is securely attached on each tab on the rear squeegee assembly.



8. Insert the hinge end of the retainer into the hooks in the rear squeegee assembly.

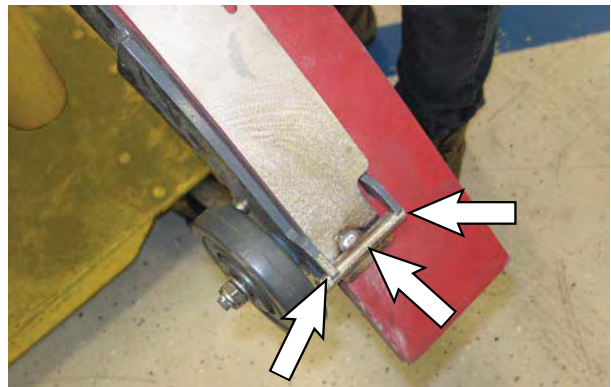

MAINTENANCE

9. Install the retainer along the rest of the squeegee assembly, align the tabs on the squeegee assembly into the slots in the retainer, and tighten the latch onto the other end of the squeegee assembly.

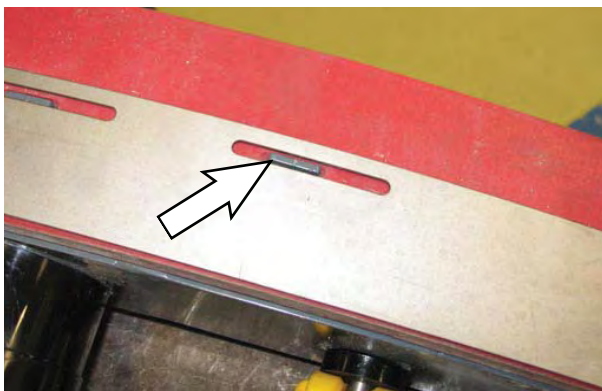

10. Turn the rear squeegee assembly over to access the front of the squeegee assembly.

11. Loosen the front retainer latch and remove the latch and the retainer from the squeegee assembly.

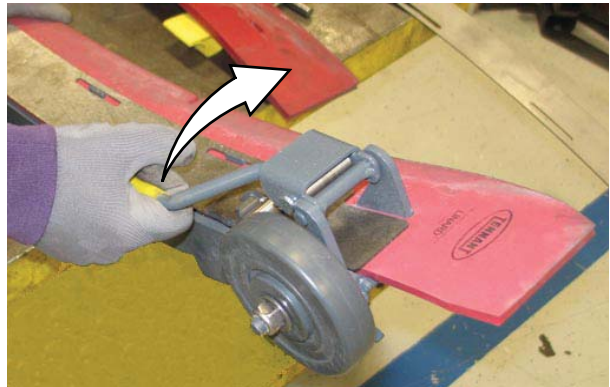

12. Remove the front squeegee from the squeegee assembly.



13. Install the rotated or new squeegee blade onto the squeegee assembly. Be sure the holes in the squeegee blade are hooked onto the tabs.

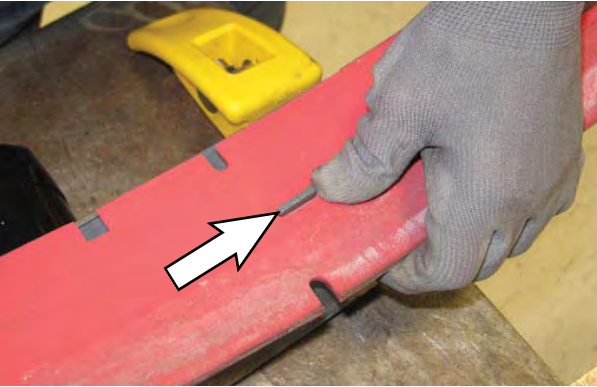

14. Install the front squeegee retainer onto the rear squeegee assembly.

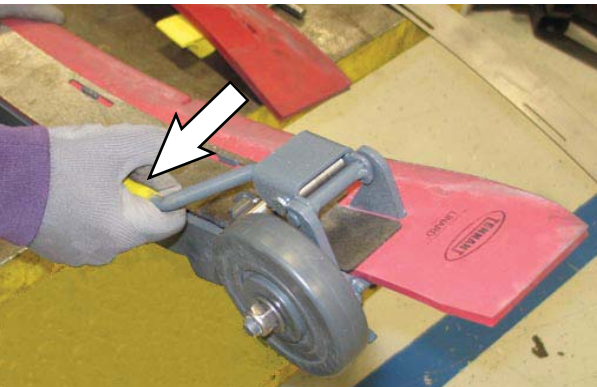
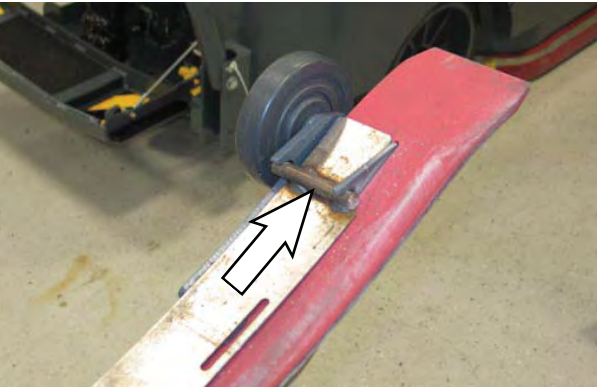

15. Reinstall the rear squeegee assembly onto the machine
16. Raise the *rear bumper door / step* if it was lowered to access the rear squeegee assembly.

MAINTENANCE

LEVELING THE REAR SQUEEGEE

Leveling the squeegee ensures the entire length of the squeegee blade is in even contact with the surface being scrubber.

1. Lower the squeegee and drive the machine several meters (feet) forward and slowly bring the machine to a stop.
2. Check the squeegee deflection over the full length of the squeegee blade.

FOR SAFETY: Before leaving or servicing machine, stop on level surface, turn off machine, set parking brake, and remove key.

3. Lower the *rear bumper door / step*.
4. If the deflection is not the same over the full length of the blade, use the tilt adjust knob to make adjustments.

DO NOT disconnect the vacuum hose from the squeegee frame when leveling squeegee.

5. To adjust the squeegee leveling, loosen the tilt lock knob.

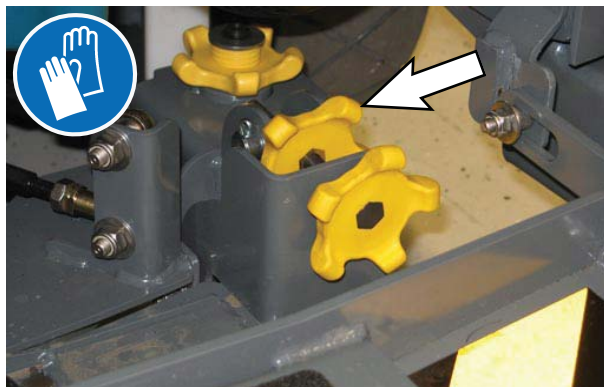

6. Turn the squeegee tilt adjust knob counter-clockwise to decrease the deflection at the ends of the squeegee blade.

Turn the squeegee tilt adjust knob clockwise to increase the deflection at the ends of the squeegee blade.

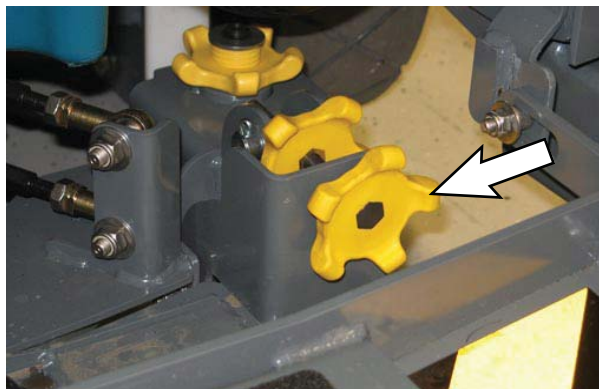

7. Tighten the tilt lock knob.
8. Drive the machine forward with the squeegee down to recheck the squeegee blade deflection if adjustments were made.
9. Readjust the squeegee blade deflection if necessary.
10. Raise the Rear bumper door / step when finished leveling the rear squeegee.

ADJUSTING THE REAR SQUEEGEE BLADE DEFLECTION

Deflection is the amount of curl the overall squeegee blade has when the machine moves forward. The best deflection is when the squeegee wipes the floor dry with a minimal amount of deflection.

NOTE: Make sure the squeegee is level before adjusting the deflection. See LEVELING THE REAR SQUEEGEE.

1. Lower the squeegee and drive the machine several meters (feet) forward and slowly bring the machine to a stop.

FOR SAFETY: Before leaving or servicing machine, stop on level surface, turn off machine, set parking brake, and remove key.

2. Look at the amount of deflection or “curl” of the squeegee blade. The correct amount of deflection is 12 mm (0.50 in) for scrubbing smooth floors and 15 mm (0.62 in) for rough floors.

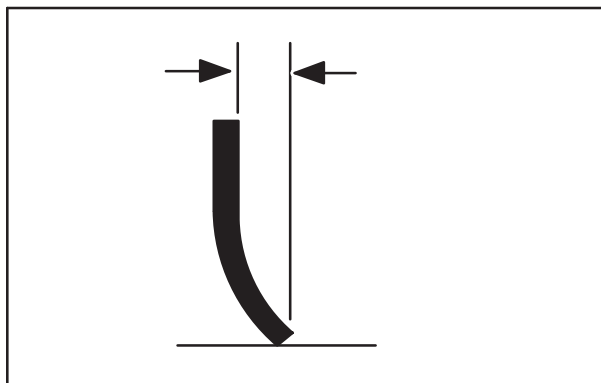

3. Lower the *rear bumper door / step*.

4. To adjust the overall squeegee blade deflection, loosen the lock knobs on both sides of the machine.

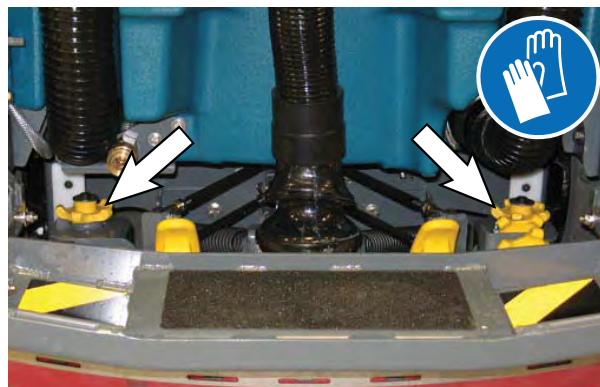

5. Turn the adjustment knobs clockwise to increase deflection or counterclockwise to decrease deflection.

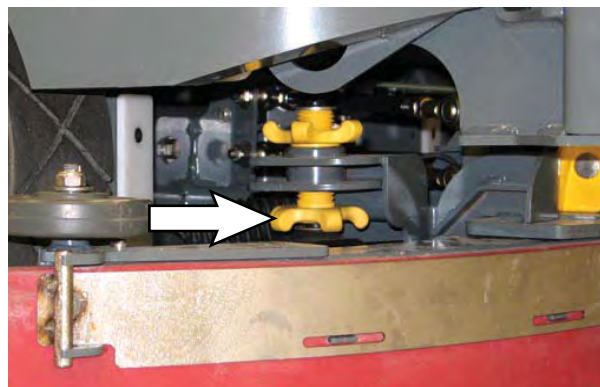

6. Retighten the lock knobs.
7. Drive the machine forward again to recheck the squeegee blade deflection.
8. Readjust the squeegee blade deflection if necessary.
9. Raise the *rear bumper door / step* when finished adjusting the rear squeegee blade deflection.

MAINTENANCE

REPLACING OR ROTATING THE SIDE SQUEEGEE BLADES

1. If necessary, raise the scrub head.

FOR SAFETY: Before leaving or servicing machine, stop on level surface, turn off machine, set parking brake, and remove key.

2. Open the main brush access door and side squeegee support door.

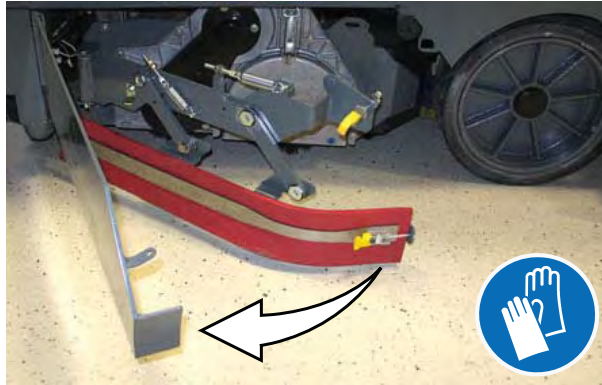

3. Unhook the retaining band latch from the side squeegee assembly.



4. Remove the retaining band from the side squeegee assembly.



5. Remove the squeegee blade from the side squeegee assembly.



6. Install the rotated or new rear squeegee blade onto the side squeegee assembly.

7. Hook the retaining band onto the retaining band retainer tab on the side squeegee assembly.

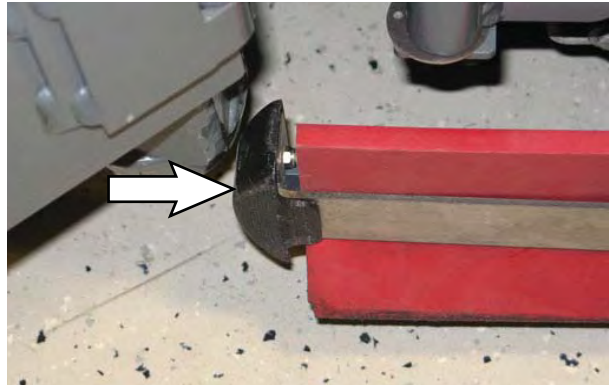

8. Fasten the retaining band latch onto the side squeegee assembly.



9. Close and secure the squeegee support door and close the main brush access door.

10. Repeat for the side squeegee on the other side of the scrub head.

REPLACING OR ROTATING THE SCRUBBING SIDE BRUSH SQUEEGEE BLADES (OPTION)

FOR SAFETY: Before leaving or servicing machine, stop on level surface, turn off machine, set parking brake, and remove key.

Check the side brush squeegee blades for damage and wear daily. Replace or rotate a blade if the leading edge is torn or worn half-way through the thickness of the blade.

1. Loosen the side brush squeegee assembly handle and remove the squeegee assembly from the machine.



2. Loosen the retaining band latch.



3. Remove the retaining band, squeegee blades, and spacer from the squeegee frame.

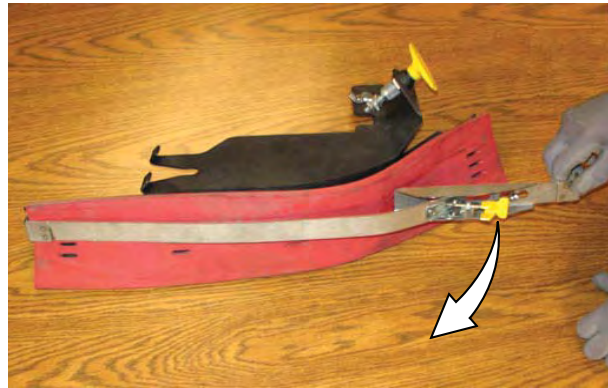

NOTE: Observe which squeegee slots were installed on the squeegee frame before removing the squeegee.



NOTE: The squeegee blade(s) have slots for adjusting the squeegee blade deflection. Install / reinstall squeegees so the deflection is approximately 12 mm (0.50 in) for smooth floors and 15 mm (0.62 in) for rough floors.

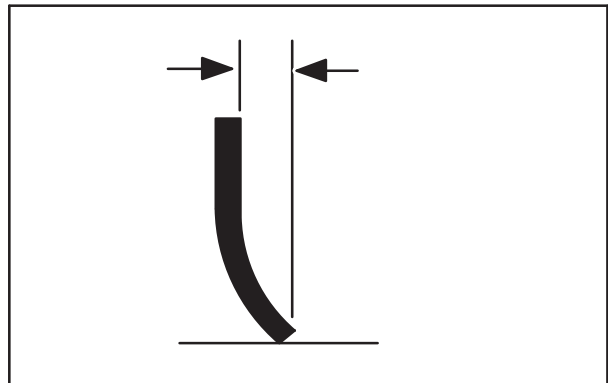

MAINTENANCE

4. Install the rotated / new squeegee blades, spacer, and retaining band onto the side brush assembly. Be sure the holes in the squeegee blade are hooked onto the tabs.

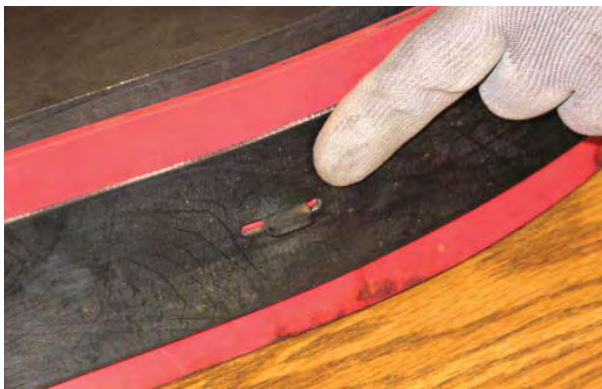

5. Fasten the side brush retaining band latch.

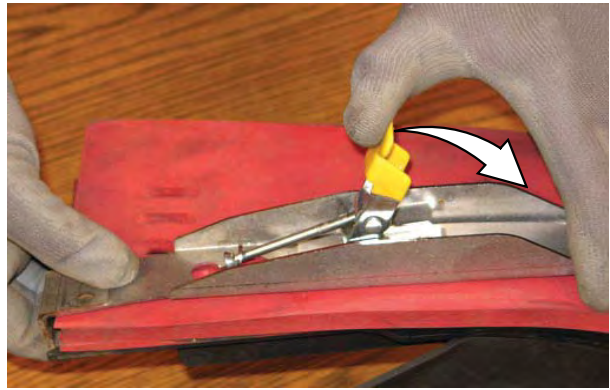

6. Reinstall the side brush squeegee assembly onto the side brush assembly.

SKIRTS AND SEALS

FOR SAFETY: Before leaving or servicing machine, stop on level surface, turn off machine, set parking brake, and remove key.

SWEEPING RECIRCULATION SKIRTS

Inspect the recirculation skirts for damage and wear after every 50 hours of operation.



SWEEPING SIDE SKIRTS

The side skirts are located on both sides of the main sweeping brushes. The side skirts should be just touching the floor. Check the skirts after every 50 hours of operation for damage and wear.

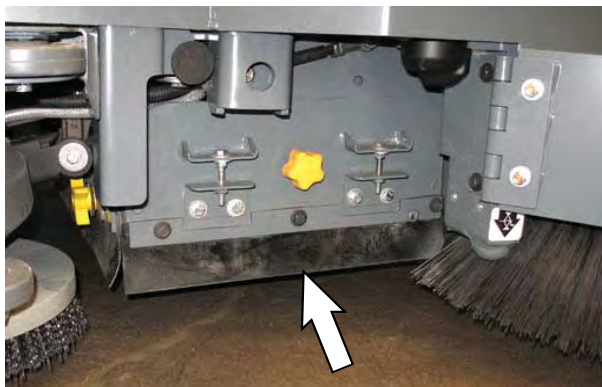

RECOVERY TANK SEAL

Check the recovery tank cover seal for damage and wear daily.



SOLUTION TANK SEAL

Check the solution tank cover seal for damage and wear daily.



MAINTENANCE

SCRUB HEAD SKIRTS (DISK SCRUB HEADS ONLY)

Check the scrub head skirts for damage and wear after every 50 hours of operation.



HOPPER DUST FILTER SEAL

Check the hopper dust filter cover seal for wear or damage every 100 hours of operation. Clean dust and debris from the seal as necessary.



HOPPER SEALS

Check the seals for damage and wear after every 100 hours of operation.

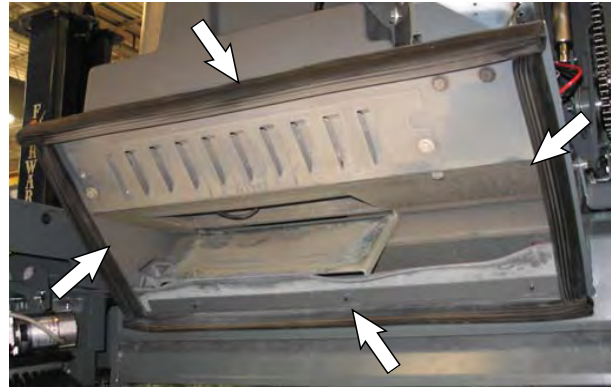

BELTS

CYLINDRICAL BRUSH DRIVE BELTS

FOR SAFETY: Before leaving or servicing machine, stop on level surface, turn off machine, set parking brake, and remove key.

The brush drive belts are located on the cylindrical brush scrub head. Check the belts for damage and wear after every 200 hours of operation.

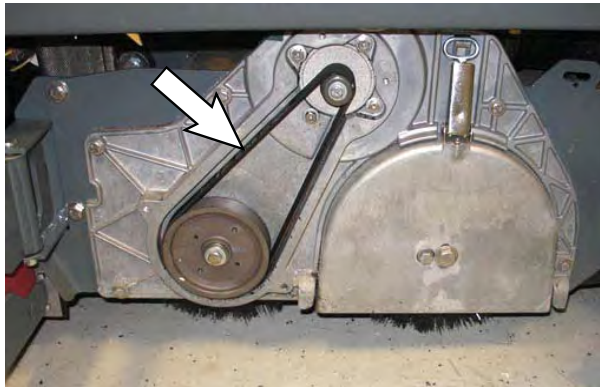

SWEEPING BRUSH DRIVE BELTS

FOR SAFETY: Before leaving or servicing machine, stop on level surface, turn off machine, set parking brake, and remove key.

The sweeping brush drive belts are located on the left side of the main sweep head. Check the belts for damage and wear after every 200 hours of operation.



BRAKES

FOR SAFETY: Before leaving or servicing machine, stop on level surface, turn off machine, set parking brake, and remove key.

The foot brake and the parking brake operate the linkage that controls the brakes on the rear wheels.

The foot pedal should not travel more than 25 mm (1 in) to engage the brake. Check the brake adjustment after every 200 hours of operation.

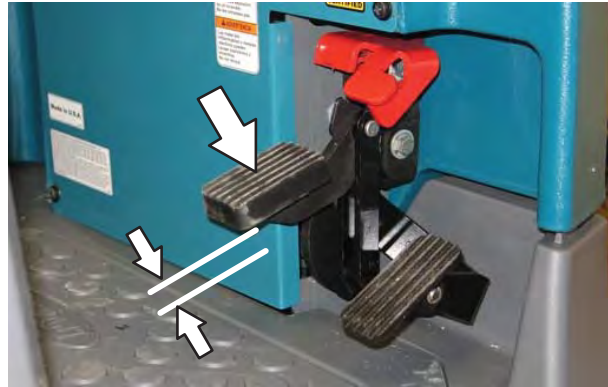

TIRES

FOR SAFETY: Before leaving or servicing machine, stop on level surface, turn off machine, set parking brake, and remove key.

The machine has three solid rubber tires: one in front, and two in the rear of the machine. Check tires for damage and wear after every 500 hours of operation.

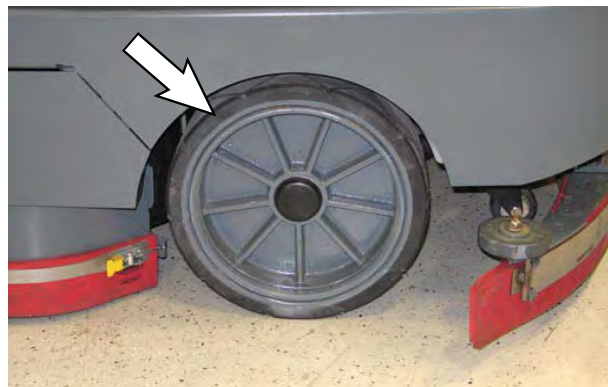

PUSHING, TOWING, AND TRANSPORTING THE MACHINE

PUSHING OR TOWING THE MACHINE

FOR SAFETY: When servicing the machine, do not push or tow the machine without an operator in the seat controlling the machine.

If the machine becomes disabled, it can be pushed from the front or rear, but it can only be towed from the front.

Only push or tow the machine for a very short distance and do not exceed 3.2 kph (2 mph). It is NOT intended to be pushed or towed for a long distance or at a high speed.

ATTENTION! Do not push or tow machine for a long distance or damage may occur to the propelling system.

TRANSPORTING THE MACHINE

1. Raise the squeegee, scrub head, and brushes.
2. Raise the hopper enough to clear ground and remove the rear squeegee if backing up onto a ramp grade of 14% or greater.

FOR SAFETY: When loading/unloading machine onto/off truck or trailer, drain tanks before loading machine.

3. Position the back end of the machine at the loading edge of the truck or trailer.
4. If the loading surface is not horizontal or is higher than 380 mm (15 in) from the ground, use a winch to load machine.

If the loading surface is horizontal AND is 380 mm (15 in) or less from the ground, the machine may be driven onto the truck or trailer.

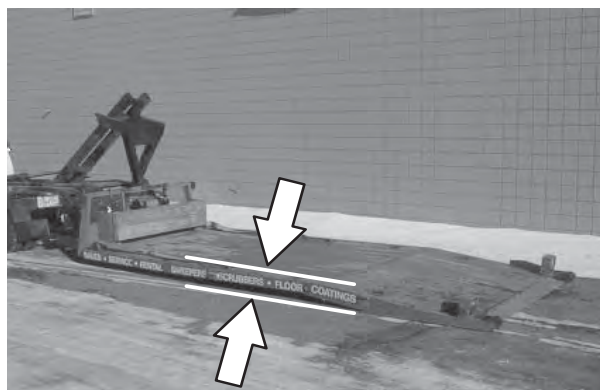

FOR SAFETY: When loading machine onto truck or trailer, use winch. Do not drive the machine onto the truck or trailer unless the loading surface is horizontal AND is 380 mm (15 in) or less from the ground.

5. Back the machine onto the trailer or truck.



- To winch the machine onto the truck or trailer, attach the winching chains to the holes in the front jacking brackets located on both sides of the machine, between the hopper and the main scrub head.



- Position the machine as close to the front of the trailer or truck as possible. If the machine starts to veer off the center line of the truck or trailer, stop and turn the steering wheel to center the machine.

NOTE: *Do not* position the front of machine against the trailer. The hopper / sweeping assemblies could be damaged due to contact of the front of the machine with the trailer during transport.



FOR SAFETY: When loading/unloading machine onto/off truck or trailer, stop on a level surface, set parking brake and leave the key in the ON position until all tie-down straps are secure.

NOTE: The drive wheel dynamic brake system is active when the key is in the ON position.

- Place a block behind each wheel to prevent the machine from rolling.
- Lower the hopper, scrub head, and rear squeegee.

- Connect the tie-down straps to the holes in the rear jacking brackets at the front of the machine.



- Turn off machine and remove the key after the machine is secured.

UNLOADING THE MACHINE

- Set parking brake and turn key to the ON position.

NOTE: The drive wheel dynamic brake system is active when the key is in the ON position.

- Unstrap machine and remove the blocks.
- If the loading surface is not horizontal or is higher than 380 mm (15 in) from the ground, use a winch to unload machine.

If the loading surface is horizontal AND is 380 mm (15 in) or less from the ground, the machine may be driven off the truck or trailer.

FOR SAFETY: When unloading machine off truck or trailer, use winch. Do not drive the machine off the truck or trailer unless the loading surface is horizontal AND 380 mm (15 in) or less from the ground.

MACHINE JACKING

FOR SAFETY: Before leaving or servicing machine, stop on level surface, turn off machine, set parking brake, and remove key.

Empty the hopper, recovery and solution tanks before jacking the machine.

Jacking point locations at the front of all machines.



Jack stand locations at the front of the machine.

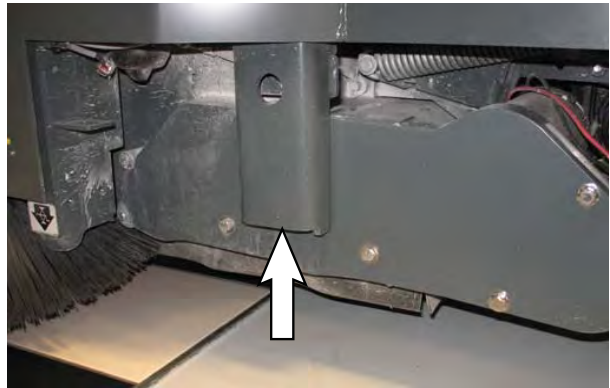
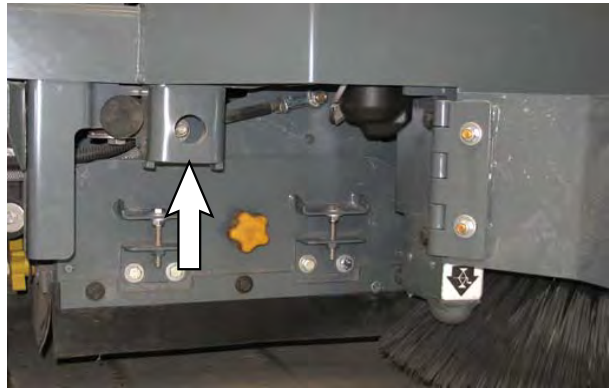

Jacking point location at the rear of all machines.



FOR SAFETY: When servicing machine, block machine tires before jacking machine up. Use a hoist or jack that will support the weight of the machine. Jack machine up at designated locations only. Support machine with jack stands.

ec-H2O MODULE FLUSH PROCEDURE

This procedure is only required when the red indicator light begins to flash and there is an audible alarm.

FOR SAFETY: Before leaving or servicing machine, stop on level surface, turn off machine, and set parking brake.

1. Open the right shroud to access the ec-H2O assembly.
2. Press the connector button to disconnect the outlet hose from the ec-H2O manifold.

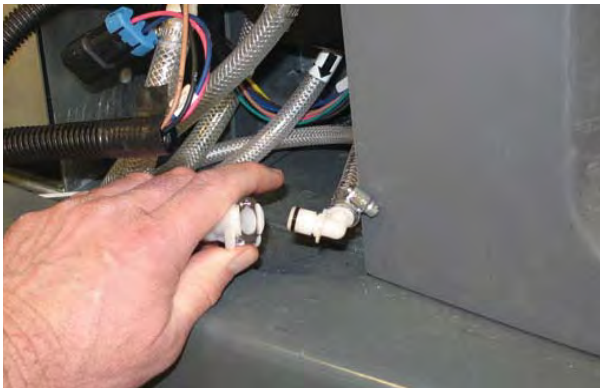

NOTE: Look for arrows on the hose near where the hose is coming from the bottom of the ec-H2O assembly to determine which hose is the outlet hose.

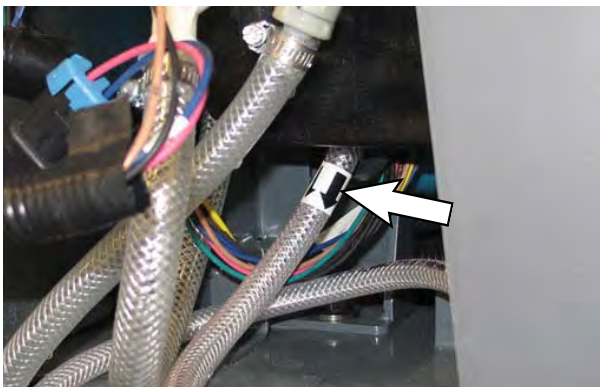

3. Remove the drain hose from the ec-H2O compartment.

4. Connect the drain hose to the ec-H2O outlet hose.



5. Place the drain hose into a empty container.



6. Pour 2 gallons (7.6 liters) of white or rice vinegar into the solution tank.

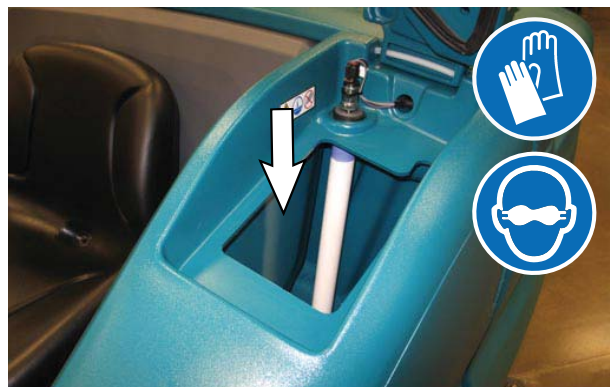

7. Turn on the machine.
8. Press and release the ec-H2O module flush switch to start the flush cycle.

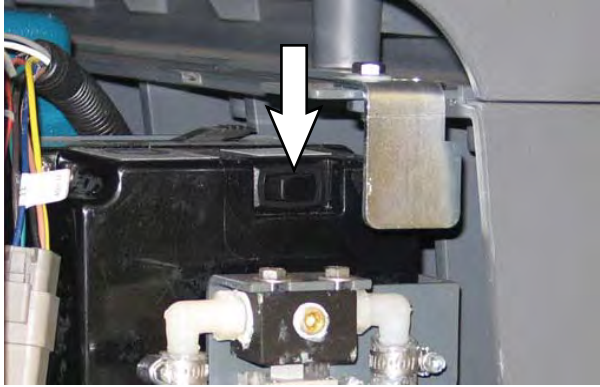

NOTE: The module will automatically shut off when the flush cycle is complete (approximately 7 minutes). The module must run the full 7-minute cycle in order to reset the system indicator light and alarm.

9. Pour 2 gallons (7.6 liters) of cool clean water into the solution tank.
10. Press and release the flush switch to rinse any remaining vinegar from the module. After 1-2 minutes, press the flush switch to turn off the module.
11. Disconnect the drain hose from the *ec-H2O* manifold hose.
12. Reconnect the outlet hose to the *ec-H2O* manifold hose.
13. Return the drain hose to storage location in the *ec-H2O* compartment.
14. Close the right shroud.

STORAGE INFORMATION

The following steps should be taken when storing the machine for extended periods of time.

1. Charge the batteries before storing machine to prolong the life of the batteries. Recharge batteries once a month.
2. Disconnect batteries before storing.
3. Thoroughly drain and rinse the solution and recovery tanks.
4. Store the machine in a dry area with the squeegee and scrub head in the up position.

ATTENTION: Do not expose machine to rain, store indoors.

5. Open the recovery tank cover to promote air circulation.
6. If storing machine in freezing temperatures, proceed to *FREEZE PROTECTION*.

NOTE: To prevent potential machine damage store machine in a rodent and insect free environment.

FREEZE PROTECTION

FOR SAFETY: Before leaving or servicing machine, stop on level surface, turn off machine, and set parking brake.

1. Completely drain the solution tank, recovery tank, and detergent tank.
2. Pour 7.6 L (2 gal) of Propylene Glycol Based / Recreational Vehicle (RV) antifreeze into the solution tank.

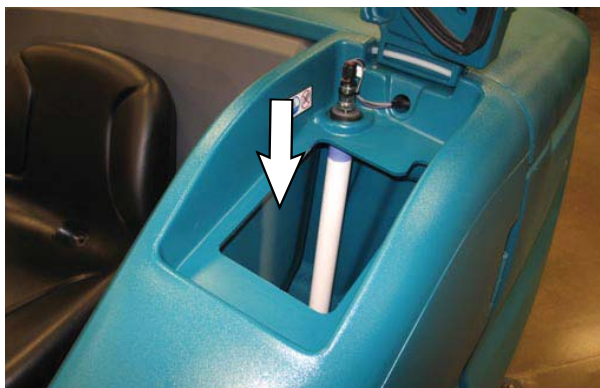

3. Machines equipped with optional detergent tank only: Pour 1.9 L (1/2 gal) of Propylene Glycol Based / Recreational Vehicle (RV) antifreeze into the detergent tank.



4. Turn on the machine.
5. Press the *1-STEP* button.

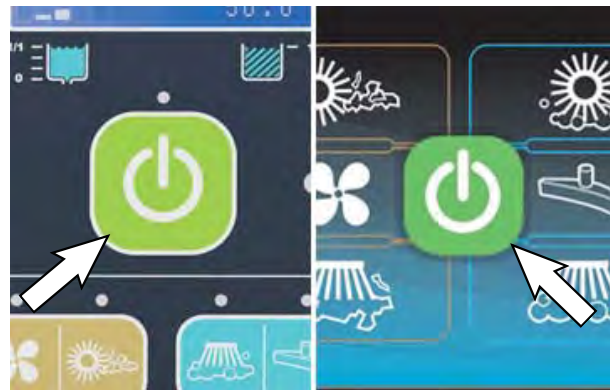

Standard Panel

Pro-Panel

6. Repeatedly press the *solution increase* button (+) until the solution flow is at the highest setting.



Standard Panel

Pro-Panel

- 7. Standard control panel machines with severe environment switch option only:** Press the bottom of the *severe environment switch* to activate the severe environment scrubbing system.

Pro-Panel machines with severe environment button option only: Press and hold the *severe environment button* to activate the severe environment scrubbing



Standard Panel

Pro-Panel

- 8. Machines with scrubbing side brush option only:** Press the *scrubbing side brush button* to activate the side brush.

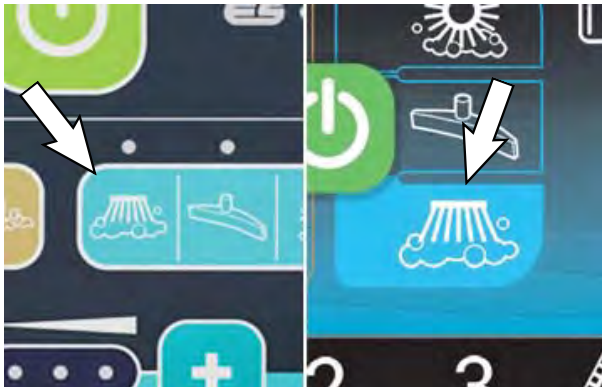

Standard Panel

Pro-Panel

9. Drive the machine to circulate the antifreeze completely through all the systems and clear out any remaining water.
- 10. Machines with scrubbing side brush option only:** Press the side brush switch to turn off the side brush.
11. Stop the machine.
- 12. Machines with spray nozzle option only:** Operate the wand for a few seconds to protect the pump.
13. Press the *1-STEP button* to turn off the system.
14. Turn off the machine.
15. The remaining antifreeze does not need to be drained from the solution tank, recovery tank, or detergent tank.

PREPARING THE MACHINE FOR OPERATION AFTER STORAGE

All antifreeze must be completely cleaned from the scrubbing system before the machine can be used for scrubbing.

FOR SAFETY: Before leaving or servicing machine, stop on level surface, turn off machine, and set parking brake.

1. Completely drain all antifreeze from the solution tank.
2. Rinse out the solution tank. Refer to *DRAINING AND CLEANING THE SOLUTION TANK* in the *OPERATION* section for instructions how to clean the solution tank.
3. Pour 11.4 L (3 gal) of cool clean water into the solution tank.



4. Machines equipped with optional detergent tank only: Pour 1.9 L (1/2 gal) of cool clean water into the detergent tank.



5. Turn on the machine.

6. Press the 1-STEP button.

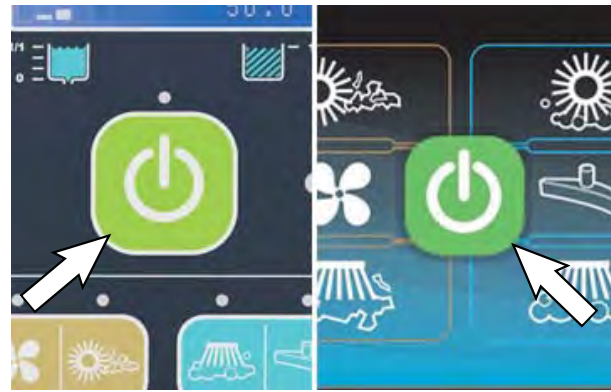

Standard Panel

Pro-Panel

7. Repeatedly press the solution increase button (+) until the solution flow is at the highest setting.



Standard Panel

Pro-Panel

NOTE: The ec-H2O systems on machines equipped with ec-H2O must be primed before the machine is ready for operation. See PRIMING THE ec-H2O SYSTEM for additional instructions.

- 8. Standard control panel machines with severe environment switch option only:** Press the bottom of the severe environment switch to activate the severe environment scrubbing system.

Pro-Panel machines with severe environment button option only: Press and hold the *severe environment button* to activate the severe environment scrubbing

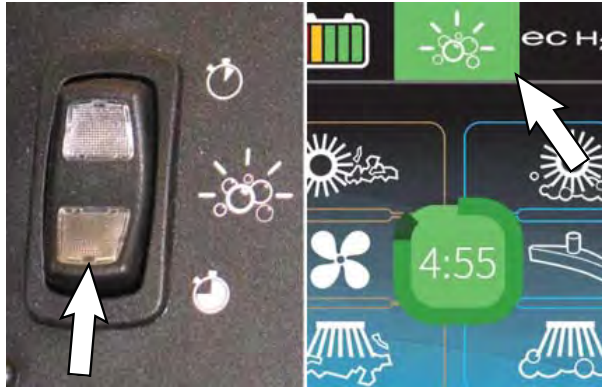

Standard Panel

Pro-Panel

- 9. Machines with scrubbing side brush option only:** Press the side brush switch to activate the side brush.

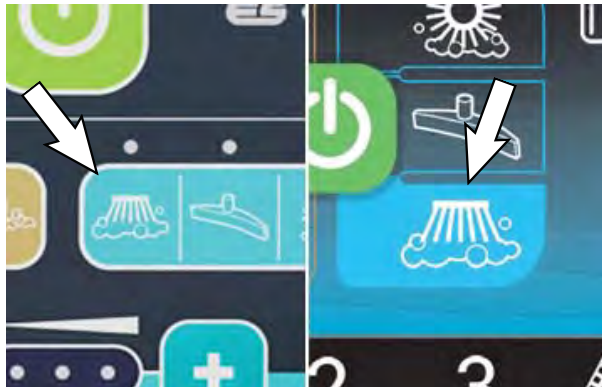

Standard Panel

Pro-Panel

10. Drive the machine until all water and antifreeze is emptied from the tanks.
- 11. Machines with scrubbing side brush option only:** Press the side brush switch to turn off the side brush.
12. Stop the machine.
- 13. Machines with spray nozzle option only:** Operate the wand for a few seconds to clean the antifreeze from the pump.
14. Press the *1-STEP button* to turn off the system.
15. Turn off the machine.

PRIMING THE ec-H2O SYSTEM

Prime the ec-H2O system if the machine has been stored for a long period with no water in the solution tank / ec-H2O system.

FOR SAFETY: Before leaving or servicing machine, stop on level surface, turn off machine, and set parking brake.

1. Fill the solution tank with clean cool water. See *FILLING THE SOLUTION TANK* section of this manual.



2. Open the right shroud to access the ec-H2O assembly.
3. Press the connector button to disconnect the outlet hose from the ec-H2O manifold.



NOTE: Look for arrows on the hose near where the hose is coming from the bottom of the ec-H2O assembly to determine which hose is the outlet hose.

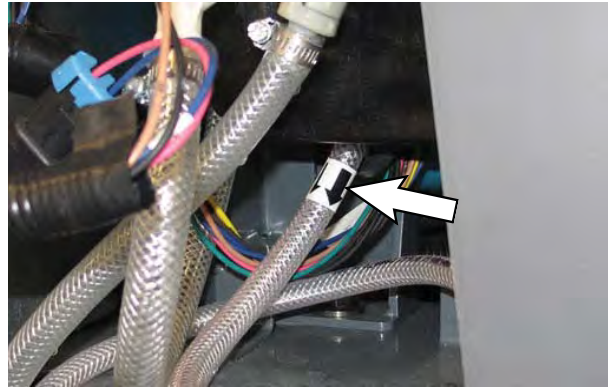

4. Remove the drain hose from the ec-H2O compartment.
5. Connect the drain hose to the ec-H2O outlet hose.



6. Place the drain hose into a empty container.



7. Turn on the machine.
8. Press and release the *ec-H2O* module flush switch. Allow the system to drain water into the container for 2 minutes.

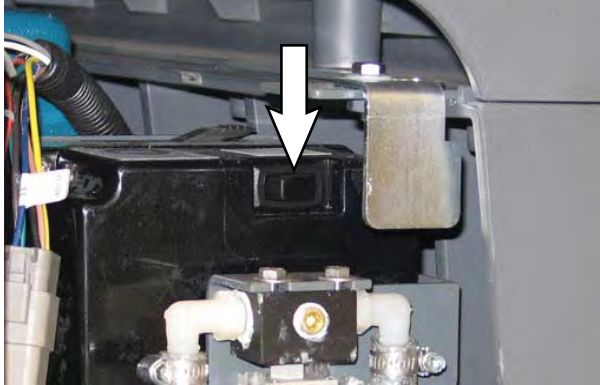

9. Press the *ec-H2O* module flush switch to shut off the system.
10. Disconnect the drain hose from the *ec-H2O* manifold hose.
11. Reconnect the outlet hose to the *ec-H2O* manifold hose.
12. Place the drain hose back into the *ec-H2O* compartment.
13. Close the right shroud.

SPECIFICATIONS

GENERAL MACHINE DIMENSIONS/
CAPACITIES

Item	Dimension / Capacity
Length	2850 mm (112.1 in)
Width (Body)	1370 mm (54 in)
Width (Body with side scrub brush)	1405 mm (55.3 in)
Wheel base	1163 mm (46 in)
Height (top of steering wheel)	1480 mm (58.25 in)
Height (with overhead guard)	2096 mm (82.5 in)
Track	1041 mm (41 in)
Disk brush diameter	510 mm (20 in)
Cylindrical brush diameter (scrubbing)	230 mm (9 in)
Cylindrical brush length (scrubbing)	1015 mm (40 in)
Cylindrical brush diameter (sweeping)	203 mm (8 in)
Cylindrical brush length (sweeping)	915 mm (36 in)
Disk brush diameter for scrubbing side brush (option)	330 mm (13 in)
Disk brush diameter for sweeping side brush	480 mm (19 in)
Scrubbing path width	1015 mm (40 in)
Scrubbing path width (with scrubbing side brush)	1220 mm (48 in)
Squeegee width (rear squeegee)	1245 mm (49 in)
Sweeping path width - main sweep	915 mm (36 in)
Sweeping path width (with dual sweeping side brushes)	1700 mm (67 in)
Solution tank capacity	285 L (75 gallons)
Recovery tank capacity	346 L (91 gallons)
Solution capacity (ES)	435 L (115 gallons)
Detergent tank capacity (option)	17.6 L (4.6 gallons)
Demisting chamber	61 L (16.1 gallons)
Hopper capacity (light litter)	85 L (3.0 ft ³)
Hopper weight capacity	136 Kg (300 lbs)
Hopper minimum ceiling dump height	2134 mm (84 in)
Hopper maximum dump height	1525 mm (60 in)
Dust filter area	5.1 m ² (54.9 ft ²)
Weight (Empty)	1515 Kg (3335 lbs)
Weight (with standard 510 AH batteries)	2165 Kg (4770 lbs)
GVWR	3245 Kg (7150 lbs)
Protection Grade	IPX3

SPECIFICATIONS

Values determined as per IEC 60335-2-72	Measure - Cylindrical scrub head	Measure - Disk scrub head
Sound pressure level LpA	75 dB	75 dB
Sound pressure uncertainty KpA	3 dB	3 dB
Sound power level LWA + Uncertainty KWA	94.63 dB + 2.98 dB	94.63 dB + 2.98 dB
Vibration - Hand-arm	<2.5 m/s ²	<2.5 m/s ²
Vibration - Whole body	<0.5 m/s ²	<0.5 m/s ²

GENERAL MACHINE PERFORMANCE

Item	Measure
Aisle turnaround width (less side brush)	3003 mm (118.25 in)
Travel Speed (Forward)	9 Km/h (5.5 mph)
Travel Speed while scrubbing (Forward)	6.5 Km/h (4 mph)
Travel Speed while sweeping (Forward)	6.5 Km/h (4 mph)
Travel Speed lifted hopper (Forward)	3.25 Km/h (2 mph)
Travel Speed dry vacuum (Forward)	3.25 Km/h (2 mph)
Travel Speed (Reverse)	5 Km/h (3 mph)
Maximum ramp incline for loading - Empty	20%
Maximum ramp incline for scrubbing	11%
Maximum ramp incline for sweeping	11%
Maximum ramp incline for transporting (GVWR)	13%
Maximum ambient temperature for machine operation	43° C (110° F)
Minimum temperature for operating machine scrubbing functions	0° C (32° F)

POWER TYPE

Type	Quantity	Volts	Ah Rating	Weight
Batteries (Max. battery dimensions): 406 mm (15.98 in) W x 963 mm (37.91 in) L x 775 mm (30.51 in) H	1	36	510 @ 6 hr rate	661 kg (1458 lb)
	1	36	750 @ 6 hr rate	963 kg (2124 lb)
	1	36	930 @ 6 hr rate	988 kg (2178 lb)

Type	Use	VDC	k W (hp)
Electric Motors	Scrub brush (disk)	36	1.125 (1.50)
	Scrub brush (cylindrical)	36	1.125 (1.50)
	Side scrub brush	36	0.90 (1.25)
	Main sweep brush	36	0.75 (1.00)
	Side sweep brush	36	0.06 (0.08)
	Vacuum fan (sweep)	36	0.85 (1.10)
	Vacuum fan (scrub)	36	0.6 (0.80)
	Propelling	36	2.25 (3.00)

SPECIFICATIONS

Type	VDC	amp	Hz	Phase	VAC
Charger (Smart)	36	80	50-60	1	200-240
Charger (Smart)	36	120	50-60	1	380-415
Charger (Smart)	36	150	50-60	1	480-600
Charger (Opportunity)	36	240	50-60	1	480

TIRES

Location	Type	Size
Front (1)	Solid	150 mm wide x 350 mm OD (5.8 in wide x 13.8 in OD)
Rear (2)	Solid	125 mm wide x 380 mm OD (5 in wide x 15 in OD)

SCRUBBING SIDE BRUSH SOLUTION FLOW RATE (OPTION)

Item	Measure
Solution pump	36 Volt DC up to 1.51 LPM (0.40 GPM)

ec-H₂O SYSTEM (OPTION)

Item	Measure
Solution pump	36 Volt DC, 5A, 6.8 LPM (1.8 GPM) open flow
Solution flow rate (machines without optional scrubbing side brush)	Up to 3.79 LPM (1.0 GPM)
Solution flow rate (machines with optional scrubbing side brush)	Up to 2.65 LPM (0.70 GMP) - To main scrub head
	Up to 1.14 LPM (0.30 GPM) - To scrubbing side brush

SPECIFICATIONS

MACHINE DIMENSIONS

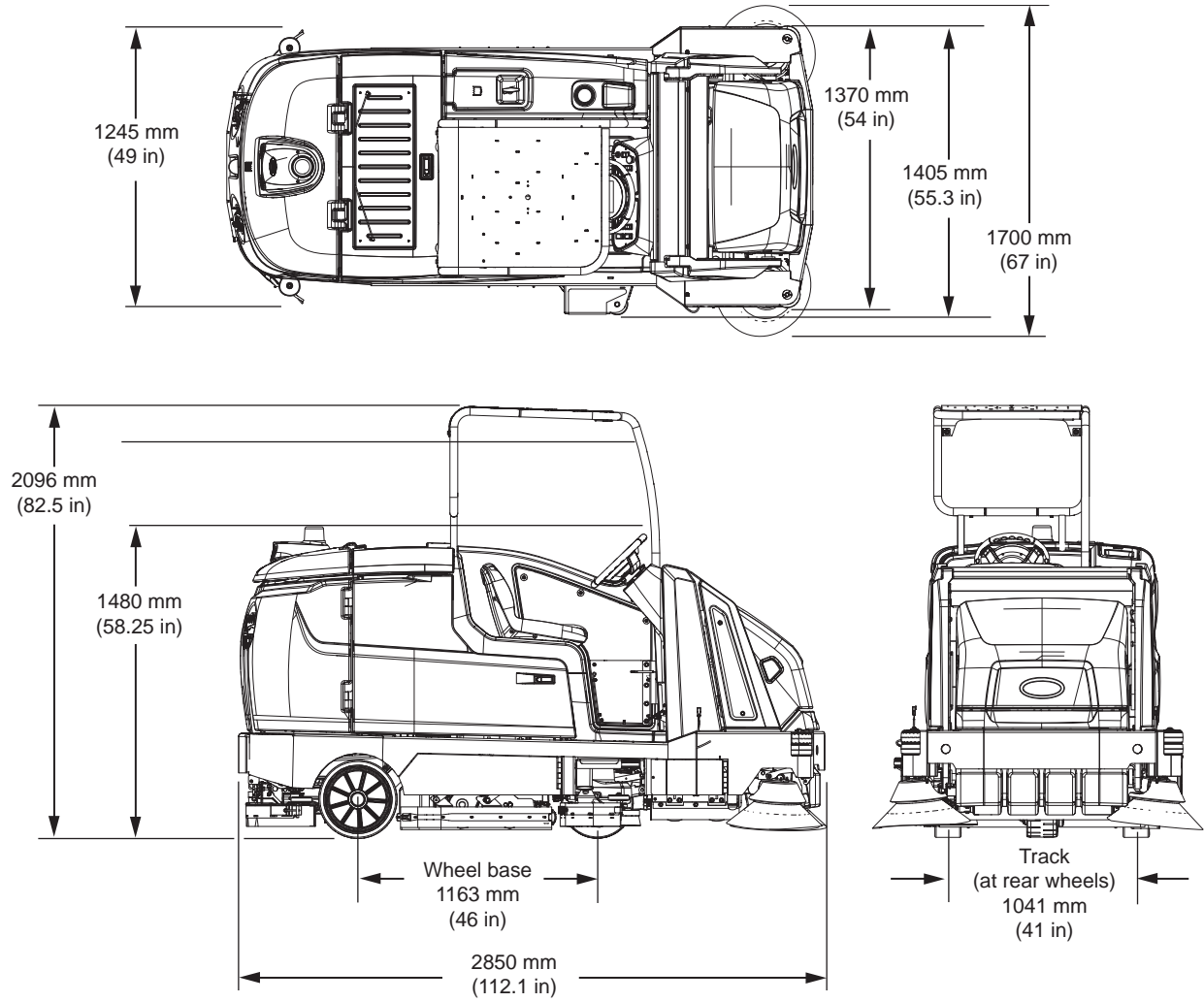

SUPERVISOR CONTROLS

PRO-PANEL SUPERVISOR CONTROLS

The supervisor controls feature allows a supervisor to program the machine scrubbing settings for operator use. The lockout functionality will prevent the operator from changing or saving the settings.

The supervisor controls feature will lower machine variability for consistent, repeatable cleaning results, machine quality assurance regardless of user experience, and reduce user training requirements.

There are two types of user modes that will interface with the operator home screen:

Operator Mode - Capable of machine operation with permissions and restrictions controlled by the supervisor.

Supervisor Mode - Capable of machine operation with full use of all controls, along with configuring permissions and restrictions for the operator mode.

A new machine from the factory will automatically start in the supervisor mode with a preassigned default supervisor profile. The factory-assigned supervisor login number is "1234". This login number is not required until it is enabled. The default supervisor profile name and login number can be changed as described in this section. If the new assigned supervisor mode login number is forgotten, please contact Tennant service.

ENTERING THE SUPERVISOR MODE - FIRST TIME USE ONLY

1. Turn on the machine. The main operating screen will appear in the display..
2. Press the help button to access the help screen.



3. Press the login button.



4. Use the keypad to enter the factory assigned supervisor login number 1234 into the display above the keypad. Press the enter button when finished entering the supervisor login number.



 Press the backspace button if necessary to delete and reenter a number.

5. The supervisor machine operation screen should appear in the display. Press the settings button to access the supervisor settings screen.



6. Proceed to *ADDING / EDITING PROFILES*.

SUPERVISOR CONTROLS

ENTERING THE SUPERVISOR MODE

1. Turn on the machine. The login screen will appear on the display.
2. Use the keypad to enter the supervisor login number into the display above the keypad. Press the enter button when finished entering the supervisor login number.



 Press the backspace button if necessary to delete and reenter a number.

3. The supervisor machine operation screen should appear in the display. Press the settings button to access the supervisor settings screen.



SUPERVISOR SETTING SCREEN / SCREEN ICONS

Use the supervisor maintenance screen to setup / change user passwords, user machine settings, and other machine setup items.

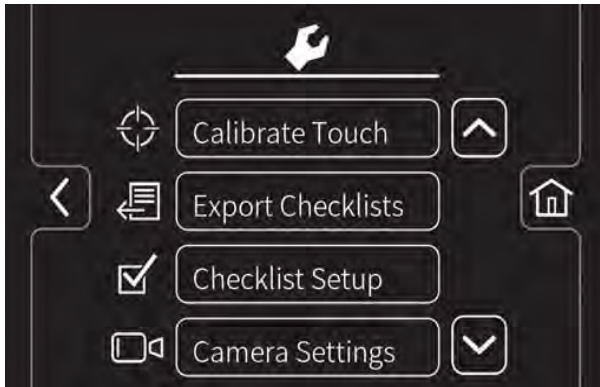
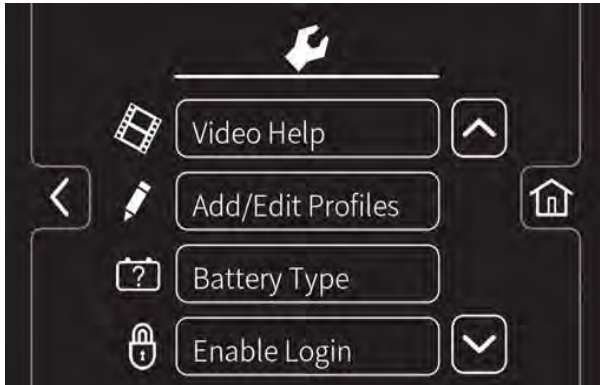

Press the up arrow button to navigate up through the menu items.



Press the down arrow button to navigate down through the menu items.



Press the home button to navigate back to the main operating screen.



Press the back button to navigate back to the previous screen.

Use the below menu buttons to access the various supervisor setup menus / screens.



Press the video help button to access the various machine help videos.



Press the Add / Edit Profiles button to add, delete, and / or change machine user and supervisor profiles. See *ADDING / EDITING PROFILES*.



Press the Battery Type button to change the type battery being used in the machine. See *CHANGING BATTERY TYPE*.



Press the Enable Login button to activate a required login number at machine start up for all user profiles to operate machine.



Press the Disable Login button to deactivate a login number at machine start up for all user profiles to operate machine. See *DISABLING LOGIN*



Press the Calibrate Touch button to calibrate the touch screen if the touch points become misaligned.



Press the Export Checklists button to access the Export Checklists menu. See *EXPORTING CHECKLISTS*.



Press the Checklists Setup button to access the Checklist Setup menu. See *DISABLING / ENABLING THE PRE-OPERATION CHECKLIST*.



Press the Camera Settings button to access the Camera Settings screen. See *CHANGING REARVIEW CAMERA SETTINGS*.



Press the SYSTEM TIME button to access the date / time screen. See *SETTING / CHANGING THE TIME AND DATE*.

SUPERVISOR CONTROLS





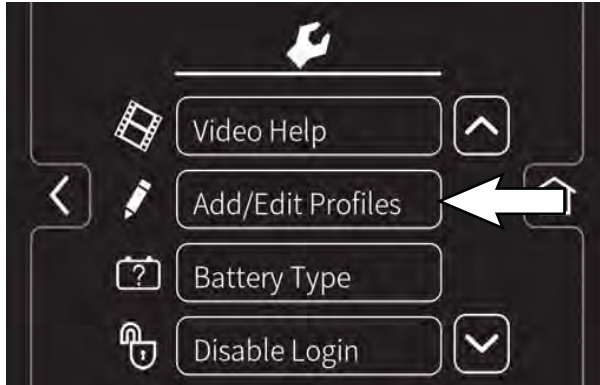

ADDING / EDITING PROFILES

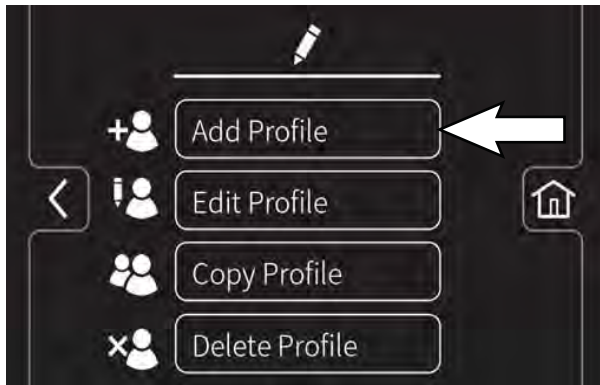
1. Turn on the machine, log into the supervisor screen, and press the settings button to access the supervisor settings screen. See *ENTERING THE SUPERVISOR MODE*.
2. Press the Add/Edit Profiles button to access the Add/Edit Profiles screen.



3. Press the Add Profile button to access the Add Profile screen.



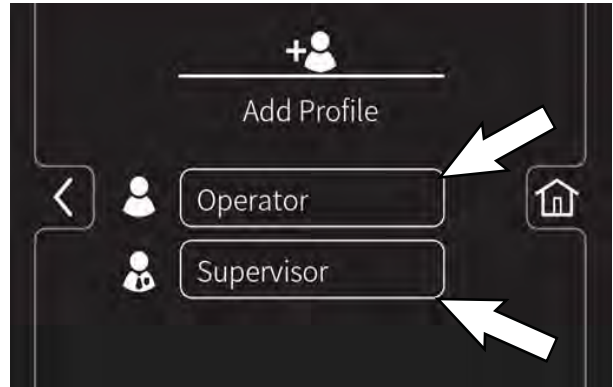

-  Press the Add Profile button to access the screens and menus to add a new profile.
-  Press the Edit Profile button to edit an existing profile.
-  Press the Copy Profile button to copy an existing profile.
-  Press the Delete Profile button to delete an existing profile.
-  Press the home button to navigate back to the main operating screen.
-  Press the back button to navigate back to the previous screen.

4. Press the Operator button to add a new operator, or Supervisor button to add a new supervisor.



NOTE: The default supervisor cannot be deleted from the profile list.

-  Press the Operator button to add / edit / copy / delete an operator profile .
-  Press the Supervisor button to add / edit / copy / delete a supervisor profile.

5. Use the keypad to enter the new user / supervisor name. Press the enter button.



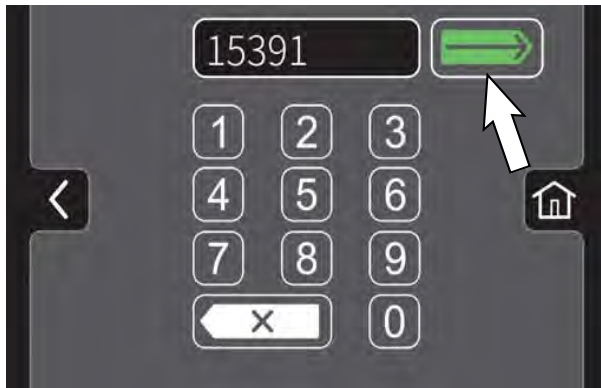

- Use the keypad to assign the new user / supervisor a login number. The new login number can be any combination of numbers ranging from 3 to 8 digits in length. Press the enter button. The “maximum speed” screen will appear.



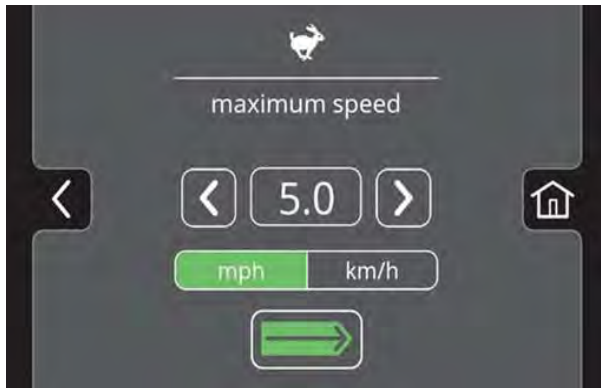

 Press the backspace button if necessary to delete and reenter a number.

- Set the maximum speed for the machine.



 Press the increase arrow button to increase the maximum speed.

 Press the decrease arrow button to decrease the maximum speed.

 Press the mph button to set the machine speed to miles per hour.

 Press the km/h button to set the machine speed to kilometers per hour.

 Press the enter button to set the maximum speed for the machine.

- Select the controls the new user should have access to use. Green represents unlocked controls and gray represents locked controls. Press the flashing save button to save the new profile.

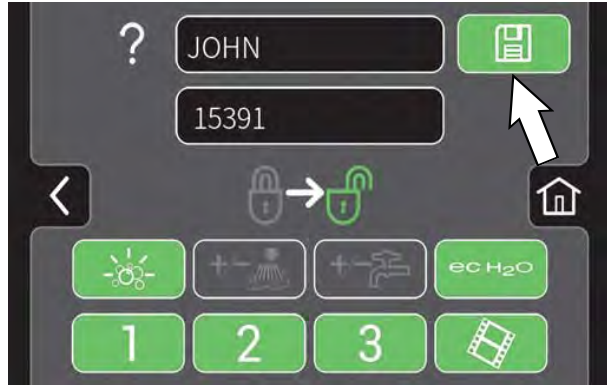

 Press the help button to access the help screen.

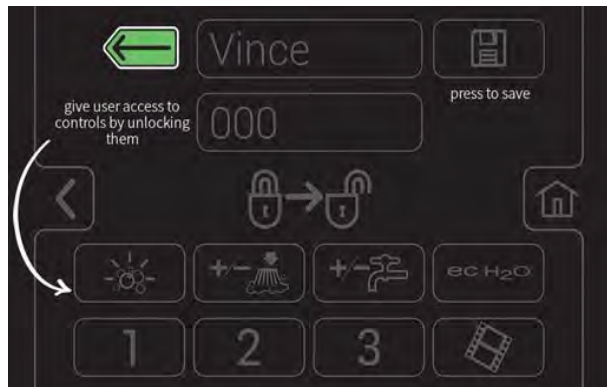

 Press the back button to return to the user access page.

- The new user profile is now saved to the operator profile list. Multiple operator and supervisor user profiles can be added. Press the back arrow button to return to the previous screen to add more user profiles or to enable login.

- To enable the login number at start up, press the Enable Login button.

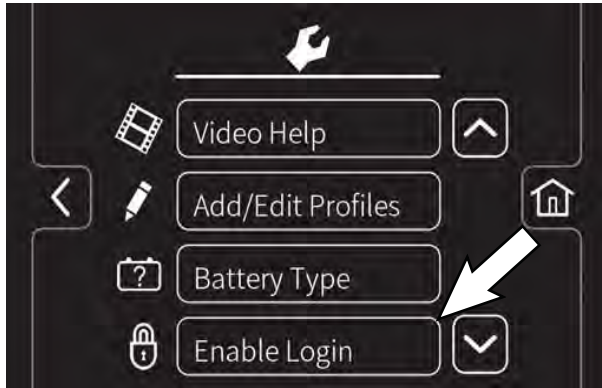

The Enable Login button will change from Enable Login to Disable Login. See *DISABLING LOGIN* for instructions how to disable login.

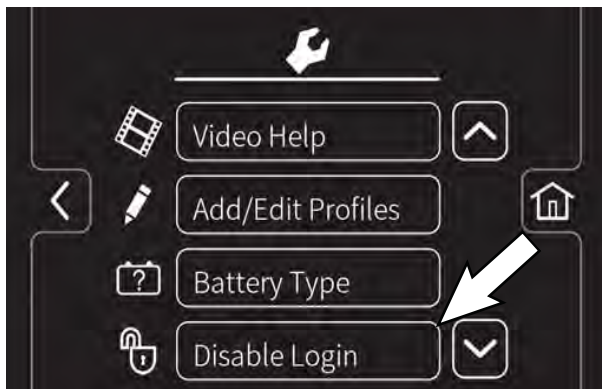

- Now at machine start up, a login screen will display. The new user will need to enter their assigned login number to operate machine.
- When the user is done operating the machine, it is recommended the user log out by pressing the help button, and then pressing the logout button. Turning the key to the off position is another way to also logout.
- Use the Edit Profile button, Copy Profile button, and Delete Profile button to manage the current user profiles.

ENABLING THE LOGIN

- Turn on the machine, log into the supervisor screen, and press the settings button to access the supervisor settings screen. See *ENTERING THE SUPERVISOR MODE*.
- Press the Enable Login button.

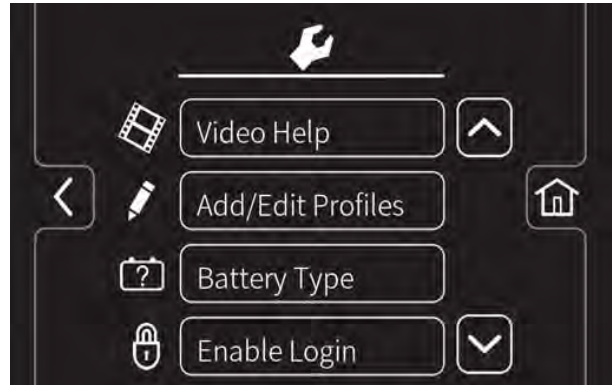

- Press the yes button to enter the Default User screen.

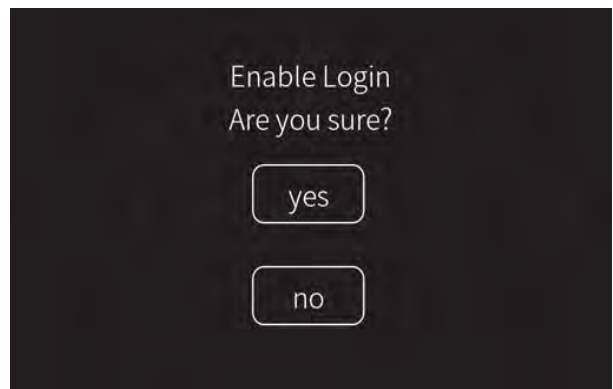

- Press either the Operator button or Supervisor button to select the desired default user.

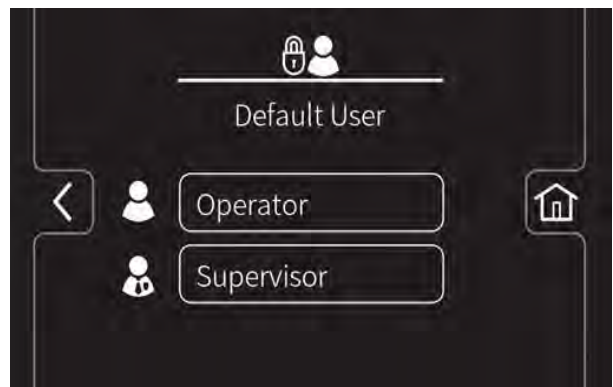

DISABLING THE LOGIN

1. Turn on the machine, log into the supervisor screen, and press the settings button to access the supervisor settings screen. See *ENTERING THE SUPERVISOR MODE*.
2. Press the Disable Login button.

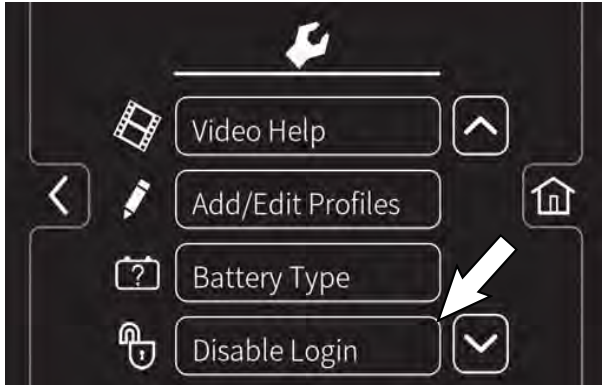

3. Press the yes button to enter the Default User screen.

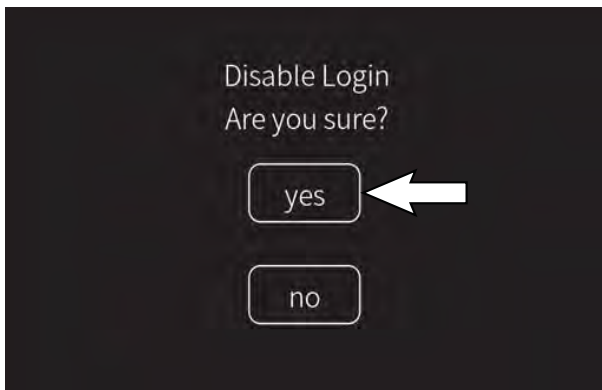

4. Press either the Operator button or Supervisor button to select the desired default user.

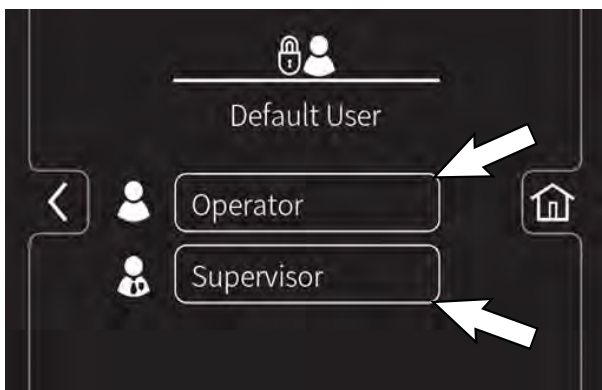

5. Select a pre-assigned user profile. Turn off the machine to apply the setting.

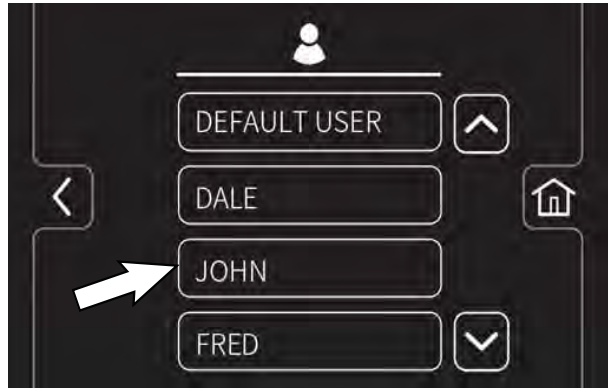

6. At start up, the home screen is now set without a login requirement for the operator profile as the default.

SUPERVISOR CONTROLS

CHANGING BATTERY TYPE

Changing the battery type allows the machine to be programmed for the correct battery type if the battery has been changed.

IMPORTANT: Before charging, make sure that the charger setting is properly set for the battery type.

NOTE: Use a charger with the proper rating for the battery to prevent damage to the battery or reduce the battery life.

1. Turn on the machine, login to the main operation screen, and press the setting button to access the supervisor settings screen. See *ENTERING THE SUPERVISOR MODE*.
2. Press the Battery Type button to access the battery selection screen.

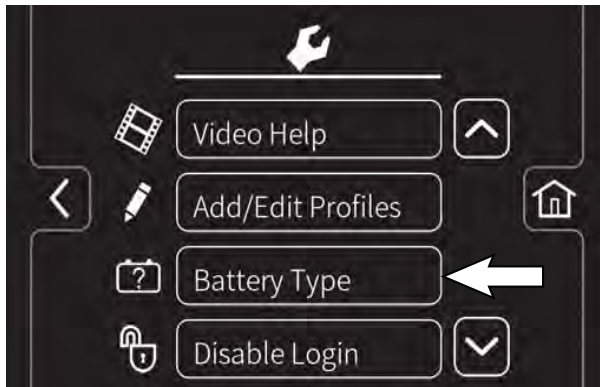

3. Press the button for the applicable battery from the list. If necessary, use the up arrow button and the down arrow button to navigate through the list of batteries.

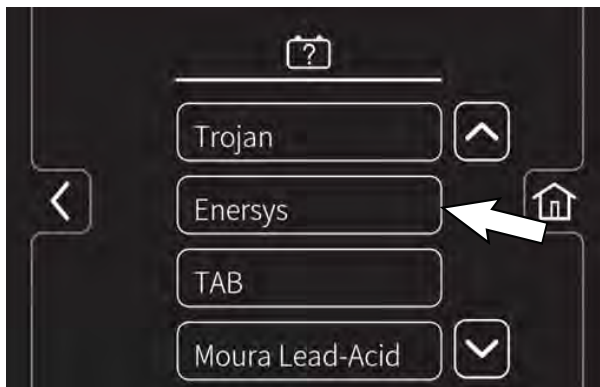

4. If a battery sub list appears on the screen, press the button for the applicable battery from the list.

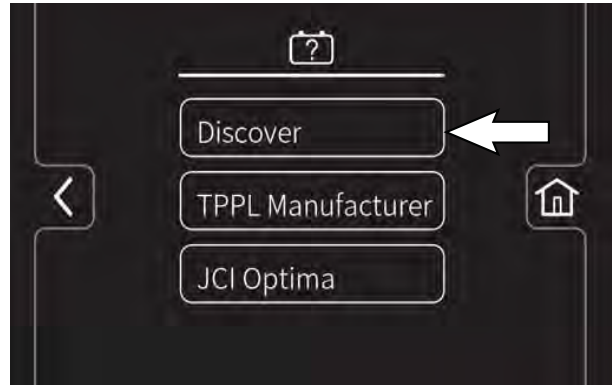

5. If Are You Sure appears on the screen, press either the yes button or the no button.

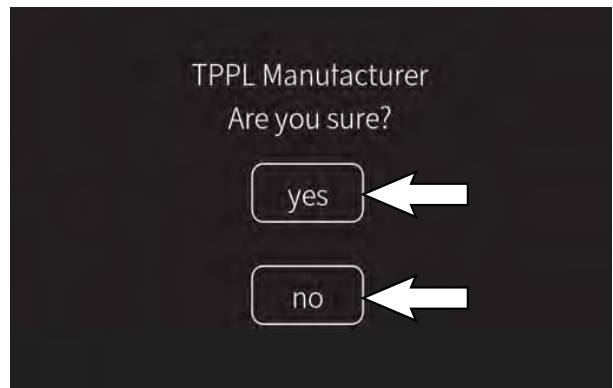

NOTE: If yes button is pushed the supervisor settings screen will reappear in the display. If the no button is pushed the applicable battery sub list will reappear in the display.

CALIBRATING THE TOUCH

1. Turn on the machine, login to the main operation screen, and press the setting button to access the supervisor settings screen. See *ENTERING THE SUPERVISOR MODE*.
2. Press the Calibrate Touch button to recalibrate touch. If the touch points become misaligned.

EXPORTING CHECKLISTS

Exporting the checklists allows the checklists to be exported from the machine and to a flash drive.

1. Turn on the machine, login to the main operation screen, and press the setting button to access the supervisor settings screen. See *ENTERING THE SUPERVISOR MODE*.
2. Plug the flash drive into the USB port.



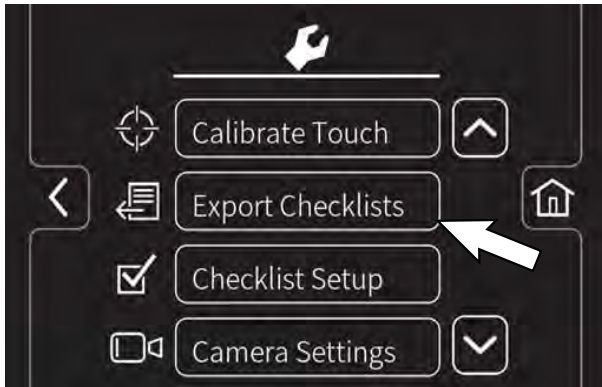

3. Press the Export Checklists button to access the export screen.



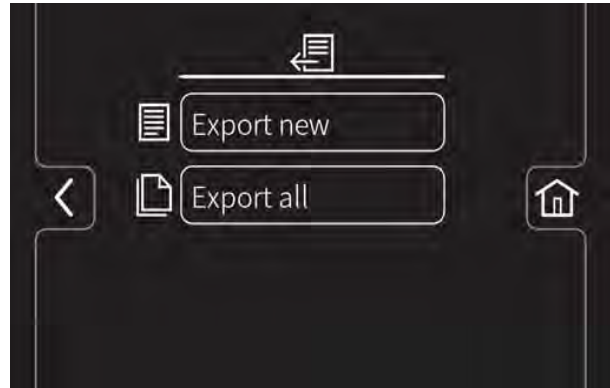

4. Export the Pre-Operation Checklists from the machine to the memory stick.



 Press the Export New button to export the newly completed Pre-Operation Checklists from the machine.

 Press the Export All button to export all completed Pre-Operation Checklists from the machine.

 Press the home button to navigate back to the main operating screen.

 Press the back button to navigate back to the previous screen.

5. Remove the flash drive from USB port and turn off the machine.

SUPERVISOR CONTROLS

CHECKLIST SETUP

Checklist setup allows the checklist to be setup / changed to meet machine usage demands.

1. Turn on the machine, login to the main operation screen, and press the setting button to access the supervisor settings screen. See *ENTERING THE SUPERVISOR MODE*.
2. Press the Checklist Setup button to access the Pre-Operation checklist setup screen.

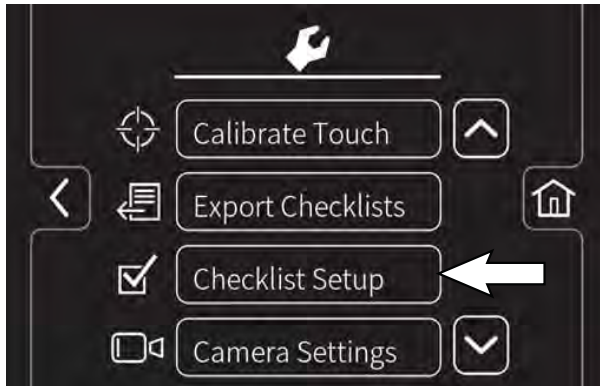

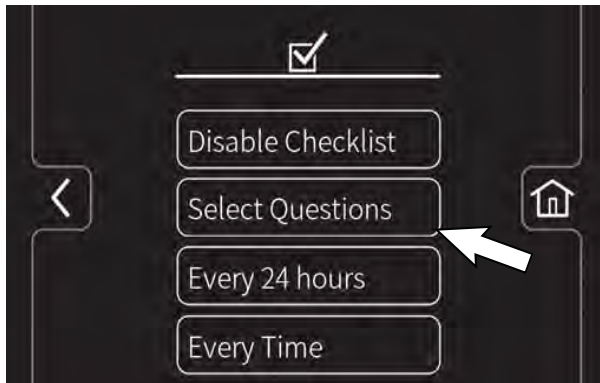

3. Press the Select Questions button to access the Pre-Operation Checklist master list screen.





-  Press the down arrow button to scroll down through Pre-Operation Checklist items.

-  Press the up arrow button to scroll up through Pre-Operation Checklist items.

-  Press the check box button to select a new checklist item to add to the checklist.

-  Press either the video help button to view the video related to a particular Pre-Operation Checklist item.

-  Press the Enter button to add the selected Pre-Operation Checklist item(s) to the Pre-Operation Checklist.

-  Press the help button to access the Pre-Operation Checklist help screen.



-  Press the back button to return to the Pre-Operation Checklist Master List screen.

4. Press the Every 12 hours button or the Every Time button to set the interval the operator must complete the Pre-Operation Checklist. A check mark appears in the chosen interval.

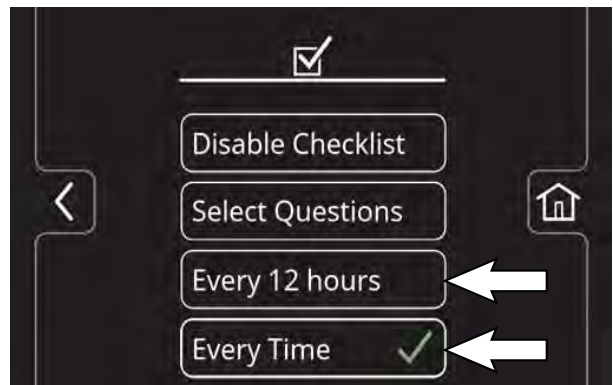

-  Press the home button to navigate back to the main operating screen.

-  Press the back button to navigate back to the previous screen.

DISABLING / ENABLING THE PRE-OPERATION CHECKLIST

Disabling / enabling the Pre-Operation checklist allows the Pre-Operation checklist to be disabled if it is not necessary for the operator to complete the checklist prior to operating the machine and enabled if it is necessary for the operator to complete the checklist prior to operating the machine.

1. Turn on the machine, login to the main operation screen, and press the setting button to access the supervisor settings screen. See *ENTERING THE SUPERVISOR MODE*.
2. Press the Checklist Setup button to access the Pre-Operation Checklist setup screen.

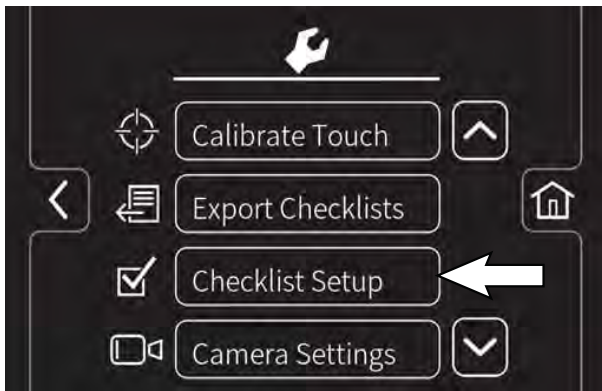

3. Press the Disable Checklist button / Enable Checklist button to disable / enable the Pre-Operation Checklist.

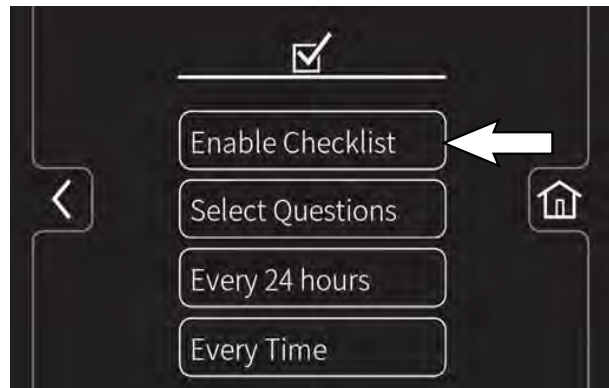
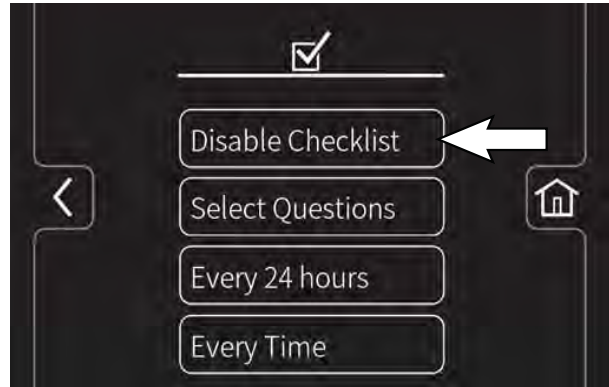

 Press the home button to navigate back to the main operating screen.

 Press the back button to navigate back to the previous screen.

SUPERVISOR CONTROLS

CHANGING THE REAR VIEW CAMERA SETTINGS

Changing the rear view camera settings allows the time the rearview camera remains on when the *rearview camera button* is pushed to be changed. The rearview camera can be set to any time between 5 seconds and 2 minutes.

1. Turn on the machine, login to the main operation screen, and press the setting button to access the supervisor settings screen. See *ENTERING THE SUPERVISOR MODE*.
2. Press the *Camera Settings button* to access the rear view camera settings screen.

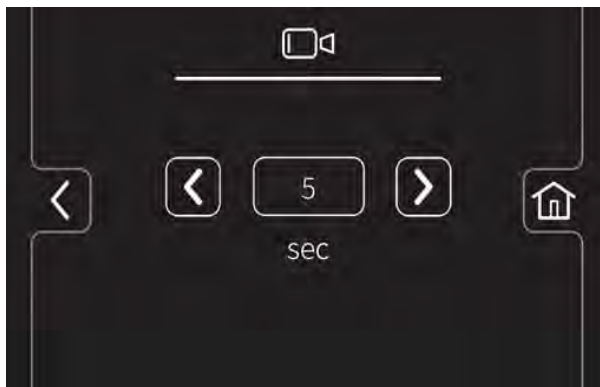
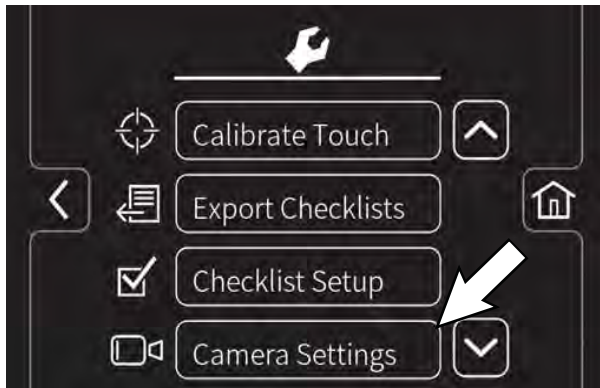

 Press the *increase button* to increase the time the rear view camera remains on when the operator presses the *rearview camera button*.

 Press the *decrease button* to decrease the time the rear view camera remains on when the operator presses the *rearview camera button*.

 Press the *home button* to navigate back to the main operating screen.

 Press the *back button* to navigate back to the previous screen.

PROGRAMMING THE ZONE CONTROL BUTTONS

Programming the zone control buttons allows the parameters for the zone control buttons to be changed / updated to meet scrubbing / sweeping demands.

1. Turn on the machine, login to the main operation screen, and press the setting button to access the supervisor settings screen. See *ENTERING THE SUPERVISOR MODE*.
2. Use the *brush pressure increase (+) button* and the *brush pressure decrease (-) button* to set the zone brush pressure.



3. Use the *solution increase (+) button* and the *solution decrease (-) button* to set the zone solution flow level.



4. Press and hold the zone control button until the “name preset” screen appears.

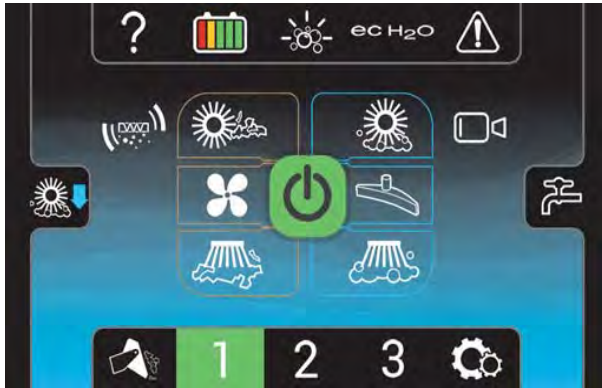



6. Use the key pad to enter the name for the zone control button.





5. Press the yes button to set the zone settings. Press the no button to return to the main operating screen.





 Press the home button to navigate back to the main operating screen.

 Press the back button to navigate back to the previous screen.

 Press the enter button to set the zone button name.

 Press the backspace button if necessary to delete and reenter a number.

 Press the space button to place space between letters / numbers.

 Press the pound button to toggle between the number keypad and the letter keypad.

SUPERVISOR CONTROLS

7. Press the enter button to set the zone button settings. The main operating screen returns to the display with the zone button named. The brush pressure and solution flow setting also briefly appear in the display.

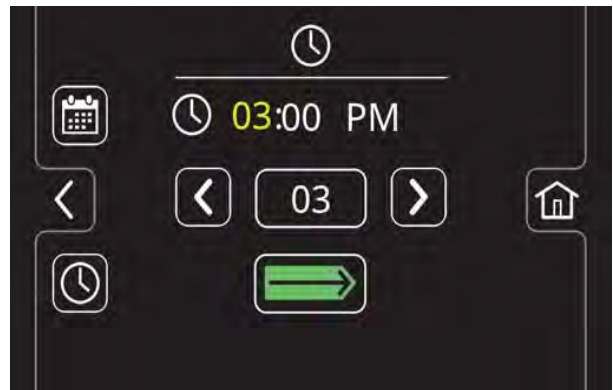
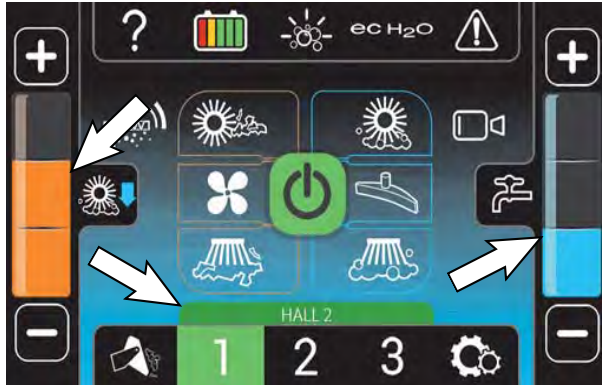



SETTING / CHANGING THE DATE AND TIME

Setting / changing the date and time allow the system date and time to be set / changed.

1. Turn on the machine, login to the main operation screen, and press the setting button to access the supervisor settings screen. See *ENTERING THE SUPERVISOR MODE*.
2. Press the *System Time* button to access the date / time screen.





 Press the *date* button to change the system date.

 Press the *time* button to change the system time.

 Press the *toggle* button to toggle between hours, minutes, and AM / PM on the time screen and the month, day, and year on the date screen.

 Press the *increase* button advance the time / date parameters.

 Press the *decrease* button to reverse the time / date parameters.

 Press the *home* button to navigate back to the main operating screen.

 Press the *back* button to navigate back to the previous screen.

3. Press the *home* button when finished setting / changing the system date and time to return to the main operating screen.

Index

Symbols

1-STEP Button , 20, 26

A

Adjusting the Rear Squeegee Blade Deflection , 107

Adjusting the Sweeping Side Brush , 98

Alerts , 62

Auto-Fill (Option) , 43

B

Backup Alarm , 68

Battery , 79

 Battery Charger USB Port , 85

 Charger Display , 82

 Charging the Battery , 80

 Checking Connections / Cleaning , 80

 Checking the Electrolyte Level , 79

 Maintenance-Free Batteries , 80

 Opportunity Charging (Option) , 85

 Weekly Equalization Charge , 86

Battery Charger Display , 82

Battery Charger USB Port , 85

Battery Charging , 80

Battery Charging, Opportunity (Option) , 85

Battery Discharge Indicator , 19

Battery Slide Out , 67

Battery Watering System (Option) , 86

Belts , 113

 Cylindrical Brush Drive Belts , 113

 Sweeping Brush Drive Belts , 113

Brake Pedal , 35

Brakes , 113

Brush and Pad Information , 38

Brushes

 Cylindrical Scrub Brushes , 95

 Disk Brushes and Pads , 93

 Main Scrub Brushes , 93

 Main Sweep Brushes , 97

 Side Brushes , 98

Brush Pressure Button , 46

Brush Pressure Decrease (-) Button , 46

Brush Pressure Increase (+) Button , 46

Brush Pressure Indicator Bar , 46

Button

 1-Step Button , 20, 26

 Configuration Mode Button , 20

 Contrast Control Button , 20

 Default , 25

 Emergency Shut-Off Button , 34

 Filter Shaker Button , 28

 Help Button , 30

 Machine Status Button , 24

 Rearview Camera Button , 29

 Scrubbing Main Brush Button , 22, 27

 Scrubbing Side Brush Button , 21, 27

 Scrubbing Vacuum Fan/Squeegee Button , 22, 27

 Severe Environment Button , 28

 Solution On/Off Button , 22, 28

 Sweeping Main Brush Button , 21, 26, 27

 Sweeping Side Brush Button , 21, 26

 Sweeping Vacuum Fan Button , 21, 26

 Video Help Button , 32

 Zone Control Button , 29

C

Camera Button , 29

Chain

 Hopper Chains , 75, 76

 Steering Chain , 75

 Steering Gear Chain , 75

Charging the Battery , 80

 ENERSYS Battery Charger , 83

 Tennant Branded Charger , 81

Chart, Maintenance , 73

Check Hydraulic Fluid Level , 77

Checking Battery Connections / Cleaning Batteries , 80

Checking the Electrolyte Level , 79

Checklist , 40

Checklist Setup , 138

Circuit Breakers , 89

Circuit Breakers, Fuses, and Relays , 89

 Circuit Breakers , 89

 Fuses , 90

 Relays , 90

Cleaning the Hopper Dust Filter , 92

Codes, Faults/Alerts , 63

Components , 12

Configuration Mode Button , 20

Contrast Control Button , 20

Controls And Instruments , 13

 Pro-Panel , 15

 Standard Control Panel , 14

Cylindrical Scrub Brushes , 95

 Replacing Cylindrical Scrub Brushes , 95

D

Default Button , 25

Detergent Tank, Option , 41

Dimensions , 125, 128

Directional Switch , 34

Disengaging the Hopper Support Bar , 56

Disk Brushes and Pads , 93

 Replacing Disk Scrub Brushes or Pad Drivers , 93

 Replacing Disk Scrub Pads , 94

Double Scrubbing , 50

Draining and Cleaning the Recovery Tank , 57

Draining and Cleaning the Solution Tank , 60

Drive Wheel Pivot , 75

Dust Filter, Hopper , 91

E

ec-H2O Button (Option) , 44
ec-H2O Module Flush Procedures , 117
Electric Motors , 90
Emergency Shut-Off Button , 34
Emptying the Hopper , 53
 Emptying the Hopper - Pro-Panel Controls , 54
 Emptying the Hopper - Standard Control Panel , 53
Emptying the Hopper - Pro-Panel , 54
Emptying the Hopper - Standard Panel , 53
Engaging the Hopper Support Bar , 56
Equalization Charge (Option) , 86
ES (Extended Scrub) Button (Option) , 45
Exporting Checklists , 137

F

Fault / Alert Indicator Button , 62
Fault / Alert Indicators - Pro-Panel , 62
 Red Fault Indicator Button , 62
 Yellow Alert Indicator Button , 62
Fault / Alert Indicators - Standard Panel , 62
Faults / Alerts , 62
 Fault / Alert Indicators - Pro-Panel Controls , 62
 Fault / Alert Indicators - Standard Control Panel , 62
Filling the Detergent Tank (Option) , 41
Filling the Solution Tank , 42
 Auto-Fill (Option) , 43
 Conventional Scrubbing Mode , 42
 ec-H2O Scrubbing (ec-H2O Mode) , 42
 ES (extended Scrub) Mode - Manual Tank Fill , 43
Filter
 Hopper Dust Filter , 91
 Perma-Filter , 92
 Solution Supply , 90
Filter Shaker Button , 28
Filter Shaker Switch , 23
Freeze Protection , 119
Fuses , 90

G

Guard, Rear Squeegee (Option) , 68

H

Hazard Light Switch (Option) , 34
Help Button , 30
Hopper Chains , 75, 76
Hopper Control Button , 29
Hopper Dust Filter / Perma-Filter , 91
 Cleaning the Hopper Dust Filter , 92
 Inspecting / Cleaning the Perma-Filter , 92
 Removing / Replacing the Hopper Dust Filter , 91

Hopper Lift Arm Pivots , 76
Hopper Raise / Lower Switch , 53
Hopper Roll Switch , 53
Hopper Support Bar , 56
Hour Meter , 19, 25
How The Machine Works , 37
Hydraulic Fluid , 78
Hydraulic Hoses , 78
Hydraulics , 77
 Check Hydraulic Fluid Level , 77
 Hydraulic Fluid , 78
 Hydraulic Hoses , 78

I

Indicator
 Battery Discharge Indicator , 19
 Recovery Tank Indicator , 19, 25
 Solution Tank Indicator , 19, 25
Inspecting / Cleaning the Perma-Filter , 92
Instrument Panel , 13

J

Jacking Machine , 116

K

Key Switch , 41

L

Leveling the Rear Squeegee , 106
Login Screen , 24, 134
Lubrication , 75
 Drive Wheel Pivot , 75
 Hopper Chains , 75
 Hopper Lift Arm Pivots , 76
 Steering Chain , 75
 Steering Gear Chain , 75

M

Machine Components , 12
Machine Jacking , 116
Machine Status Button , 24
Machine Troubleshooting , 69
Main Scrub Brushes , 93
 Cylindrical Scrub Brushes , 95
 Disk Brushes and Pads , 93
 Replacing Disk Scrub Brushes or Pad Drivers , 93
 Replacing Disk Scrub Pads , 94
Main Sweep Brushes , 97
 Replacing the Main Sweeping Brush , 97
Maintenance , 72
 Battery , 79
 Checking Connections / Cleaning , 80
 Checking the Electrolyte Level , 79
 Belts , 113
 Brakes , 113
 Circuit Breakers , 89

- ec-H2O Module , 117
 - Electric Motors , 90
 - Fuses , 90
 - Hopper Dust Filter / Perma-Filter , 91
 - Hydraulics , 77
 - Lubrication , 75
 - Machine Jacking , 116
 - Main Scrub Brushes , 93
 - Main Sweep Brushes , 97
 - Pushing, Towing, and Transporting the Machine , 114
 - Relays , 90
 - Side Brushes , 98
 - Skirts and Seals , 111
 - Squeegee Blades , 102
 - Storage Information , 119
 - Tires , 113
 - Maintenance Chart , 73
 - Maintenance-Free Batteries , 80
 - Motors, Electric , 90
- O**
- Operating / Hazard Light Switch (Option) , 34
 - Operation of Controls - All Machines , 34
 - Brake Pedal , 35
 - Directional Switch , 34
 - Emergency Shut-Off Button , 34
 - Key Switch , 41
 - Operating / Hazard Light Switch (Option) , 34
 - Operator Seat , 35
 - Parking Brake Pedal , 35
 - Propel Pedal , 35
 - Rear Bumper Door / Step , 36
 - Seat Belts (Deluxe Seat Option Only) , 35
 - Spray Nozzle Switch , 64
 - Operation of Controls - Pro-Panel
 - 1-STEP Button , 26
 - Brush Pressure Button , 46
 - Brush Pressure Decrease (-) Button , 46
 - Brush Pressure Increase (+) Button , 46
 - Brush Pressure Indicator Bar , 46
 - ec-H2O Button (Option) , 44
 - Fault / Alert Indicator Button , 62
 - Filter Shaker Button , 28
 - Help Button , 30
 - Hopper Control Button , 29
 - Machine Status Button , 24
 - Pro-ID Login Screen , 24
 - Rearview Camera Button , 29
 - Scrubbing Main Brush Button , 27
 - Scrubbing Side Brush Button , 27
 - Severe Environment Button (Option) , 28
 - Solution Decrease (-) Button , 47
 - Solution Flow Button , 47
 - Solution Flow Indicator Bar , 47
 - Solution Increase (+) Button , 47
 - Solution On / Off Button , 28
 - Sweeping Main Brush Button , 26, 27
 - Sweeping Side Brush Button , 26
 - Sweeping Vacuum Fan Button , 26
 - Vacuum Fan / Squeegee Button , 27
 - Video Help Button , 32
 - Zone Control Buttons , 29
 - Operation of Controls - Standard Panel , 19
 - 1-STEP Button , 20
 - Battery Discharge Indicator , 19
 - Configuration Mode Button , 20
 - Contrast Control Button , 20
 - ec-H2O Button (Option) , 44
 - ES (Extended Scrub) Button (Option) , 45
 - Filter Shaker Switch , 23
 - Hopper Raise / Lower Switch , 53
 - Hopper Roll Switch , 53
 - Hour Meter , 19
 - Recovery Tank Full Indicator , 19
 - Scrubbing Main Brush Button , 22
 - Scrubbing Side Brush Button , 21
 - Scrub Brush Pressure Button , 46
 - Severe Environment Switch (Option) , 23
 - Solution Decrease (-) Button , 47
 - Solution Increase (+) Button , 47
 - Solution On / Off Button , 22
 - Solution Tank Indicator , 19
 - Sweeping Main Brush Button , 21
 - Sweeping Side Brush Button , 21
 - Sweeping Vacuum Button , 21
 - Vacuum Fan / Squeegee Button , 22
 - Operator Seat , 35
 - Opportunity Charging (Option) , 85
 - Weekly Equalization Charge , 86
 - Options , 64
 - Auto-Fill , 43
 - Detergent Tank , 41
 - ec-H2O , 44
 - ES (Extended Scrub) , 45
 - Rear Squeegee Guard (Option) , 68
 - Slide Out Battery (Option) , 67
 - Spray Nozzle (Option) , 64
 - Vacuum Wand (Option) , 65
- P**
- Pad Information , 38
 - Parking Brake Pedal , 35
 - Pedal
 - Brake Pedal , 35
 - Parking Brake Pedal , 35
 - Propel Pedal , 35
 - Perma-Filter , 92
 - Pre-Operation Checklist , 40
 - Preparing the Machine for Operation After Storage , 121
 - Priming the ec-H2O System , 123
 - Profiles, Adding , 132
 - Pro-ID Login Screen , 24
 - Pro-Panel Controls , 15
 - Propel Pedal , 35

- Pushing, Towing, and Transporting the Machine , 114
Pushing or Towing the Machine , 114
Transporting the Machine , 114
- R**
- Rear Bumper Door / Step , 36
Rear Squeegee
Adjusting the Rear Squeegee Blade Deflection , 107
Leveling the Rear Squeegee , 106
Replacing Rear Squeegee Blades , 102
Rear Squeegee Guard (Option) , 68
Rearview Camera Button , 29
Recovery Tank Full Indicator , 19
Red Fault Indicator Button , 62
Relays , 90
Removing / Replacing the Hopper Dust Filter , 91
Replacing Disk Scrub Brushes or Pad Drivers , 93
Replacing the Main Sweeping Brush , 97
Replacing the Scrubbing Side Brush , 101
Replacing the Sweeping Side Brush , 98
- S**
- Scrubbing Main Brush Button , 22, 27
Scrubbing Side Brush
Replacing the Scrubbing Side Brush , 101
Scrubbing Side Brush Button , 21, 27
Scrubbing Side Brush Squeegee Blades
Replacing Scrubbing Side Brush Squeegee Blades , 109
Scrubbing / Sweeping - Pro-Panel , 49
Scrubbing / Sweeping - Standard Panel , 48
Scrubbing Vacuum Fan / Squeegee Button , 22, 27
Scrub Brush Pressure , 46
Setting the Brush Pressure - Standard Control Panel , 46
Setting the Solution Flow - Pro-Panel Controls , 47
Scrub Brush Pressure Button , 46
Seals , 111
Hopper Dust Filter Seal , 112
Hopper Seals , 112
Recovery Tank Seal , 111
Solution Tank Seal , 111
Seat Belts (Deluxe Seat Option Only) , 35
Settings Button, Switching Mode , 24
Setting the Brush Pressure - Pro-Panel , 46
Setting the Brush Pressure - Standard Panel , 46
Setting the Solution Flow - Pro-Panel , 47
Setting the Solution Flow - Standard Panel , 47
Severe Environment Button (Option) , 28
Severe Environment Switch (Option) , 23
Side Brushes , 98
Scrubbing Side Brush , 101
Sweeping Side Brushes , 98
Side Squeegee
Replacing the Side Squeegee Blades , 108
Skirts and Seals , 111
Hopper Dust Filter Seal , 112
Hopper Seals , 112
Recovery Tank Seal , 111
Scrub Head Skirts (Disk Scrub Heads Only) , 112
Solution Tank Seal , 111
Sweeping Recirculation Skirts , 111
Sweeping Side Skirts , 111
Slide Out Battery (Option) , 67
Solution Decrease (-) Button , 47
Solution Decrease Button (-) , 47
Solution Flow , 47
Setting the Solution Flow - Pro-Panel Controls , 47
Setting the Solution Flow - Standard Control Panel , 47
Solution Flow Button , 47
Solution Flow Indicator Bar , 47
Solution Increase (+) Button , 47
Solution Increase Button (+) , 47
Solution On / Off Button , 22, 28
Solution Supply Filter , 90
Solution Tank Indicator , 19
Specifications , 125
ec-H2O System (Option) , 127
General machine dimensions / capacities , 125
General machine Performances , 126
Machine dimensions , 128
Power type , 126
Scrubbing side brush solution flow rate (Option) , 127
Tires , 127
Spray Nozzle (Option) , 64
Spray Nozzle Switch , 64
Squeegee Blades , 102
Rear Squeegee Blades , 102
Scrubbing Side Brush Squeegee Blades , 109
Side Squeegee Blades , 108
Standard Control Panel , 14
Starting the Machine , 41
Steering Chain , 75
Steering Gear Chain , 75
Stop Cleaning , 52
Storage Information , 119
Freeze Protection , 119
Preparing the Machine for Operation After Storage , 121
Priming the ec-H2O System , 123
Supervisor Controls , 129
Pro-Panel supervisor controls , 129
Supervisor Mode , 130
Supervisor Setting Screen , 131
Sweeping Main Brush Button , 21, 26, 27
Sweeping Side Brush Button , 21, 26
Sweeping Side Brushes , 98
Adjusting the Sweeping Side Brushes , 98
Replacing the Sweeping Side Brush , 98

To Adjust Sweeping Side Brush - Pro-Panel ,
100
To Adjust Sweeping Side Brush - Standard Panel
, 99
Sweeping Vacuum Button , 21
Sweeping Vacuum Fan Button , 26
Switch
Directional Switch , 34
Filter Shaker Switch , 23
Operating/Hazard Light Switch , 34
Severe Environment Switch (Option) , 23
Symbol Definition , 16

T

Thermo-Sentry , 92
Tires , 113
Specifications , 127
Towing the Machine , 114
Transporting the Machine , 114
Unloading the machine , 115
Troubleshooting , 69
Turn Off the Machine , 61

U

Unloading the machine , 115
USB Port
Charger , 85
Pro-Panel , 137

V

Vacuum Fan Button, Scrubbing , 22, 27
Vacuum Fan Button, Sweeping , 21, 26
Vacuum Wand (Option) , 65
Video Help Button , 32

W

Water Pickup Mode (No Scrubbing) , 52
Weekly Equalization Charge , 86
While Operating the Machine , 39

Y

Yellow Alert Indicator Button , 62
Yellow Touch Points , 75

Z

Zone Control Buttons , 29

