



The National Super Service Company (NSS®)
3115 Frenchmens Road • Toledo, Ohio 43607 USA
Tel. (419) 531-2121 • Fax: (419) 531-3761

TWO MOTOR UPRIGHT VACUUM

MARSHALL 14

OPERATION MANUAL

PLEASE READ BEFORE OPERATING AND KEEP
STORED INSIDE BAG HOUSING FOR READY RE-
FERENCE

OPERATING INSTRUCTIONS PAGE 2-8

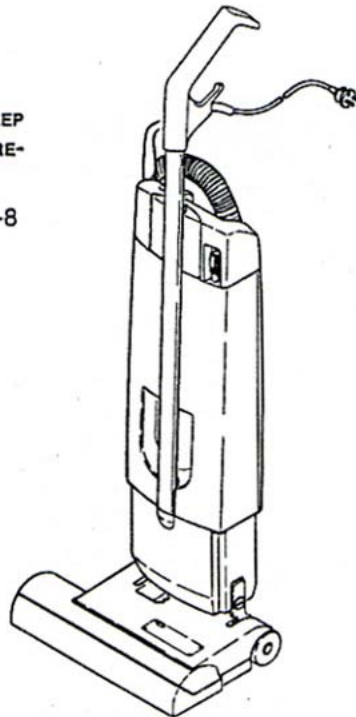

Contents

1. Unit diagram	4
2. Technical data	4
3. Starting the unit and handling	5
3.1 Connect the upper section of the vacuum cleaner to the power nozzle	5
3.2 Storing and removing cable	5
3.3 On and off positions	5
3.4 Working with the suction hose	5
3.5 Adjusting the carpet brush	6
3.6 Electronic brush monitoring	6
3.7 Red indicator light in handle	6
4. Accessories	6
5. Care and maintenance	7
5.1 Replacing the paper filter bag	7
5.2 Replacing the safety filter	7
5.3 Replacing the exhaust filter	7
5.4 Replacing the brush strip	7
6. Troubleshooting	8

**Important Instructions****READ ALL INSTRUCTIONS BEFORE USING THIS MACHINE.****Transport damages**

If the goods have been damaged in transit, please notify NSS®.

Warranty

If your upright vacuum has to be repaired under terms of the conditions of warranty, please consult your NSS® Distributor. Always return the complete vacuum cleaner.

The conditions of warranty issued by NSS® apply. If a malfunction is due to a defect in materials or manufacturing, we undertake to repair your upright vacuum at no charge in accordance with the conditions of the NSS® warranty.

Grounding Instructions

This appliance must be grounded. If it should malfunction or breakdown, grounding provides a path of least resistance for electric current to reduce the risk of electric shock. This appliance is equipped with a cord having an equipment-grounding conductor and grounding plug. The plug must be plugged into an appropriate outlet that is properly installed and grounded in accordance with all local codes and ordinances.

Improper connection of the equipment-grounding conductor can result in a risk of electric shock. Check with a qualified electrician or service person if you are in doubt as to whether the outlet is properly grounded. Do not modify the plug provided with the appliance.

Safety Instructions

When using an electrical appliance, basic precautions should always be followed, including the following:

This machine is for commercial use.

Warning: To reduce the risk of fire, electric shock, or injury:

1. Do not operate without filters in place.
2. Use only as described in this manual.

3. Use indoors only. Do not use outdoors and do not expose to rain.
4. Do not operate this machine near flammable fluids, dust or vapors.
5. Do not pick up flammable or combustible materials such as gasoline or use where they may be present.
6. Do not vacuum anything that is burning or smoking, such as cigarettes, matches or hot ashes.
7. Do not handle the plug or machine with wet hands.
8. Do not leave the machine unattended. Unplug machine from outlet when not in use and **before** servicing.
9. Turn off all controls, before unplugging the machine.
10. Do not unplug machine by pulling on cord. To unplug, grasp the plug, not the cord.
11. Do not use with damaged cord or plug. Connect to a properly grounded outlet (see grounding instructions).
12. If the machine is not working properly, has been dropped, damaged, left outdoors or dropped into water, return it to your authorized NSS® distributor.
13. Do not pull or carry by cord, use cord as a handle, close a door on cord or pull cord around sharp edges or corners.
14. Do not pull / run machine over cord. Keep cord away from heated surfaces.
15. Close attention is necessary when used by or near children.
16. Do not operate machine with any openings blocked. Keep openings free of debris that may reduce airflow.
17. Keep hair, loose clothing, fingers and all parts of the body away from openings and moving parts.
18. Use extra caution when cleaning on stairs.
19. Do not use machine as a step.
20. Maintenance and repairs must be done by qualified personnel.

SAVE THESE INSTRUCTIONS

1. Unit diagram

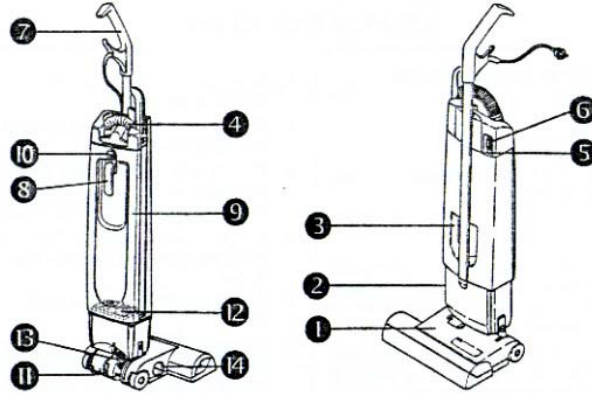

- | | | | |
|---|--|----|--|
| 1 | Brush head with brush monitoring | 8 | Lower cable clip |
| 2 | Vacuum housing | 9 | Cover |
| 3 | Recessed handle | 10 | Cover fastener |
| 4 | Suction hose with handle | 11 | Latch pedal |
| 5 | Red indicator light | 12 | Safety filter |
| 6 | ON/OFF switch with green indicator light | 13 | Connecting hose |
| 7 | Handle with upper cable clip | 14 | Brush adjustment knob (adjustable to pile depth) |

2. Technical data

Blower data:			
Power P _{NOM} watt		850
Power P _{MAX}	8 AMPS	watt	950
Low air pressure	CLOSED W.L. 55"	mbar	186
Air quantity	CFM 51 " @ 1-1/4 "	L/sec	46
Brush:			
Brush motor watt		150
Drive	toothed belt	
Sweep width	14.3 "	mm	335
Brush strip is exchangeable			
Dimensions and weights:			
Height	48.75 "	mm	1250
Width	14.5 "	mm	360
Weight	17.6 LBS	approx. kg	8
Sound pressure level	dB(A)	67

Subject to technical modifications

3. Starting the unit and handling

3.1 Connect the upper section of the vacuum cleaner to the power nozzle

Unscrew both fastening screws from the upper section of the vacuum cleaner before assembly.

Push the upper section of the vacuum cleaner upright onto the brush head. Then insert the two support arms into the grooves provided on the upper section of the vacuum cleaner. Fasten with screws. Tighten screws firmly. <Figure 2>

Connect the hose to the brush head and upper section of vacuum cleaner. Plug the connecting cable with plug at the bottom of the power head into the female receptable at the bottom of the vacuum housing. <Figure 3>

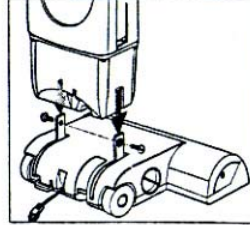

Figure 2

3.2 Storing and removing cable

The vacuum cleaner's power cable can be wound up around the upper and lower cable clips. The entire cable can be easily removed by turning the lower cable clip.

3.3 On and off positions

The power nozzle has a pivot latch which locks the unit in the upright off position. To operate, tread on the latched pedal and tip the handle backwards. <Figure 4>

Caution: do not drive the rotating brushes over the connecting cable. Carry the unit over steps and high thresholds.

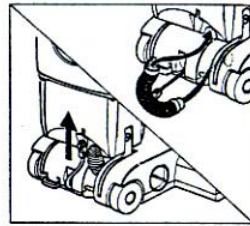

Figure 3

3.4 Working with the suction hose <Figure 5>

Switch the unit on via the ON/OFF switch (green light still luminated)..

Please note: The carpet brush switches on automatically once the suction hose with handle is firmly located in the motor housing. Please check.

If the suction hose with handle is pulled out of the motor housing for vacuuming, the brush drive motor switches off automatically. The suction hose is stretched when removed and increases the working radius for above-the-floor cleaning.

The hose handle can be separated in the middle (bayonet connection). The crevice and upholstery nozzle can be attached to both ends.

Important: Never use the hand pipe for vacuuming without first attaching either the crevice nozzle or the upholstery nozzle (the cleaner will malfunction if the end of the hand pipe is worn down – see Section 6 for Troubleshooting).

The suction handle is inserted back into the vacuum motor housing to activate the brush motor.

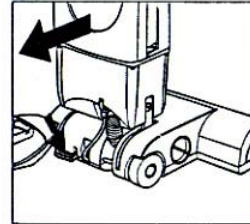

Figure 4

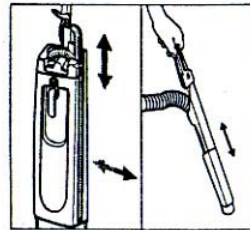

Figure 5

3.5 Adjusting the carpet brush

The carpet brush can be adjusted to match the height of the pile. To do this, set the vacuum cleaner to the working position (approx. 45°) and select the required setting between 1 and 4. <Figure 6>

Note: The brush cannot be adjusted when the cleaner is in the upright position

Position 1: shallow pile

Position 2: deep pile

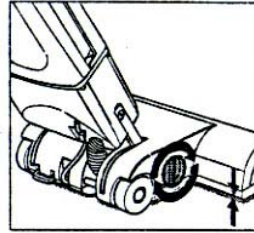

Figure 6

3.6 Electronic brush monitoring

Brush functioning is continuously controlled by electronic monitoring.

not illuminated:

brush functioning properly

orange light on:

set the pile height adjusting knob at a lower pile height

orange light on even at the lowest setting:

change brush strip.

3.7 Red indicator light

If the indicator light is on, please check the following:

- a) is the filter bag full?
- b) is the suction hose or connecting hose blocked?

Either exchange the filter bag or eliminate blockages.

Please note: There is no defect when the warning light comes on while placing your hand at the suction hose inlet.

4. Accessories

	<i>Order no.</i>
Crevice nozzle	68-026-1
Upholstery nozzle	68-025-1
Brush strip, black	68-078-1
* Brush strip, red (hard)	68-077-1
** Paper filter bags (10 units)	68-024-1
Safety filter	68-016-1
* Microfilter	68-017-1
* not included in the scope of supply	
** 1 unit included in the scope of supply	

5. Care and maintenance

5.1 Replacing the paper filter bag <Figure 7>

- Depress the cover fastener and remove cover.
- Push the filter bag catch to the left until it is possible to pull the filter bag off the connection piece.

Assembly:

- Insert the narrow end of the support card into the holder.
- Push the filter bag catch to the left and guide the support card upwards over the connection piece until it slots in.
- Replace the cover.

Please note: If the cover does not close, check whether the filter bag has been inserted properly.

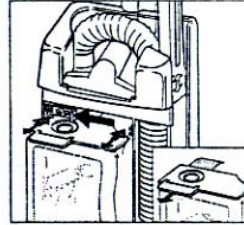

Figure 7

5.2 Replacing the safety filter <Figure 8>

After changing the filter bag approximately 20 times, change the safety filter.

- Press cover fastener and remove cover.
- Lift the red locking device and pull out the safety filter.

Assembly:

- Lift the red locking device and insert the new safety filter.

Please note: If the cover does not close, check whether the filter bag has been inserted properly.

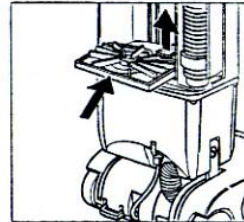

Figure 8

5.3 Replacing the exhaust filter <Figure 9>

After changing the filter bag approximately 20 times, change the exhaust filter.

Push the exhaust filter off the housing and remove.

Assembly:

- Insert the new exhaust filter.

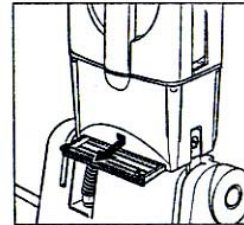

Figure 9

5.4 Replacing the brush strip <Figure 10>

- Remove power cable from electrical outlet.
- Unscrew the power nozzle cover. Turn the brush so that the brush strip can be pushed or pulled through the opening.

Assembly:

- Insert the new brush strip and screw the cover on again.

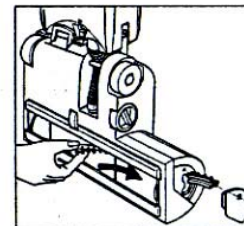

Figure 10

6. Troubleshooting

Caution: Always remove the cable from the electrical outlet before attempting any type of service to the machine !

The brush and suction motor not operating, and noted by electronic system (green indicator light still illuminated)

Brush is blocked

- Unplug unit, check brush for any litter and, if necessary remove the blockage. Machine is now ready to operate.

Suction motor not running / Brush motor functioning (red indicator light goes off)

Thermal switch has disengaged motor due to overheating

- Unplug cable, replace full filter bag or remove suction hose blockage. After approximately 20 minutes, the unit will start up again.

Suction hose is blocked

- Switch off the unit. Remove the flexible hose from the housing and pull it straight. Use something long to remove the hose blockage.
- The suction hose can be disconnected from the unit by pressing the locking lever. <Figure 11>

Connecting hose is blocked

- The connecting hose can be removed by pulling out both ends. Remove blockage. <Figure 12>

Brushes in brush head are not rotating, suction turbine is running

Hand pipe is not pushed into motor housing properly, or end is worn down

- If the end of the pipe has been worn down (due to vacuuming without first fitting the crevice or upholstery nozzle), the end switch will not be actuated and the brushes will not rotate.

Separating the power nozzle from the upper section of the vacuum cleaner

- Unplug the connecting cord from the vacuum motor housing. Release the plug by pressing in a pointed object (e.g. screwdriver). <Figure 13>
- Remove the connecting hose from the brush head and the open housing.
- Undo both screws at the side of the upper section to the vacuum cleaner. Lift off.

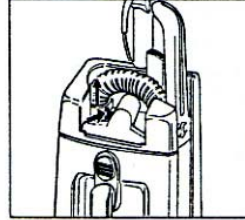

Figure 11

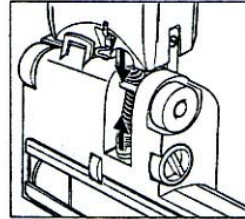

Figure 12

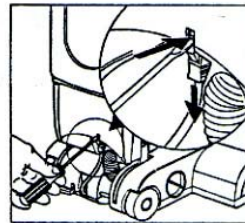

Figure 13