



NSS Enterprises, Inc.

PACER 12UE, 15UE

UPRIGHT VACUUM CLEANERS

OPERATOR MANUAL

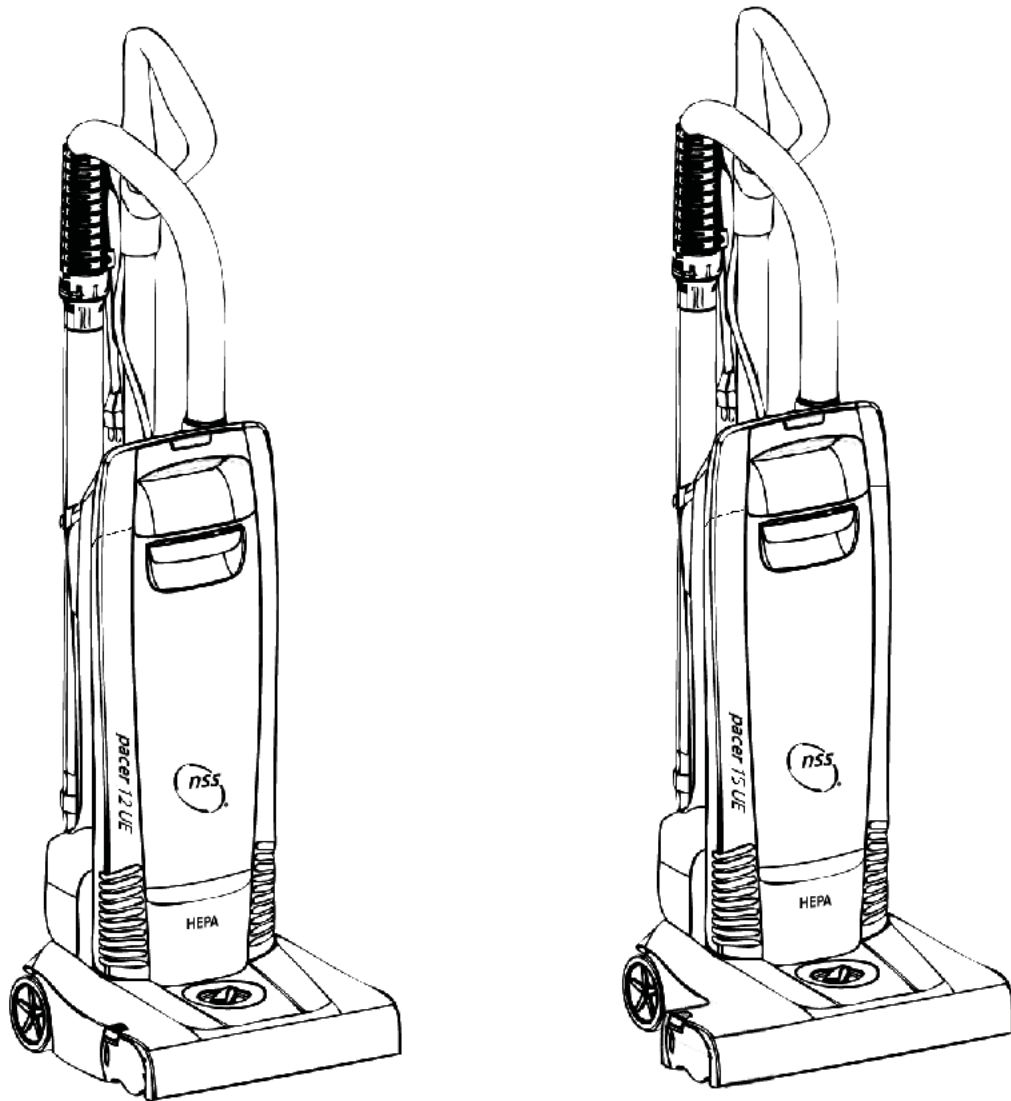

IMPORTANT SAFETY INSTRUCTIONS

When using an electrical appliance, basic precautions should always be followed, including the following:

READ ALL INSTRUCTIONS BEFORE USING THIS APPLIANCE.

For Commercial Use Only

WARNING - To reduce the risk of fire, electric shock, or injury:

-Do not leave appliance when plugged in. Unplug from outlet when not in use and before servicing.

WARNING - To reduce the Risk of Electric Shock - Do not use outdoors or on wet surfaces.

WARNING - To reduce the Risk of Fire or Electric Shock Use Appliance Only With NSS Part No. 9697271 Supply Cord. If cord is damaged or lost, replace with part #9697271.

-Do not allow to be used as a toy. Close attention is necessary when used by or near children.

-Use only as described in this manual. Use only manufacturer's recommended attachments.

-Do not use with damaged cord or plug. If appliance is not working as it should, has been dropped, damaged, left outdoors, or dropped into water, return it to a service center.

-Do not pull or carry by cord, use cord as a handle, close a door on cord, or pull cord around sharp edges or corners. Do not run appliance over cord. Keep cord away from heated surfaces.

-Do not unplug by pulling on cord. To unplug, grasp the plug, not the cord.

-Do not handle plug or appliance with wet hands.

-Do not put any object into openings. Do not use with any opening blocked; keep free of dust, lint, hair, and anything that may reduce air flow.

-Keep hair, loose clothing, fingers, and all parts of body away from openings and moving parts.

-Turn off all controls before unplugging.

-Use extra care when cleaning on stairs.

-Do not use to pick up flammable or combustible liquids, such as gasoline, or use in areas where they may be present.

-Connect to a properly grounded outlet only. See Grounding Instructions.

-Do not pick up anything that is burning or smoking, such as cigarettes, matches, or hot ashes.

-Do not use without dust bag and/or filters in place.

SAVE THESE INSTRUCTIONS

INSTRUCCIONES IMPORTANTES DE SEGURIDAD

Cuando se utiliza un aparato eléctrico, hay ciertas precauciones que deben seguirse, incluyendo las siguientes:

LEER TODAS LAS INSTRUCCIONES ANTES DE USAR ESTE APARATO.

Para uso comercial

ADVERTENCIA - Para reducir el riesgo de incendio, choque eléctrico o lesiones: -No deje el aparato enchufado Desenchufe del tomacorriente cuando no esté en uso y antes de limpiarla.

ADVERTENCIA - Para reducir el riesgo de descarga eléctrica - No use al aire libre o en superficies mojadas.

ADVERTENCIA - Para reducir el riesgo de incendio o descarga eléctrica Appliance Use solamente con la parte del cable de suministro N ° 9697271 NSS. Si el cable se daña o se pierde, vuelva a colocar con la parte # 9697271.

-No permita que se use como un juguete. Preste especial atención cuando es utilizado por o cerca de niños.

-Utilizar sólo como se describe en este manual. Use los accesorios recomendados por el fabricante.

-No lo use con cable o enchufe dañado. Si el aparato no funciona como debería, se ha caído, dañado, dejado afuera o caído al agua, devuélvala a un centro de servicio.

-No tire ni transporte del cable, ni use el cordón como un mango, no cierre la puerta sobre el cordón, ni tire del cordón alrededor de bordes afilados o esquinas. No pase el aparato sobre el cordón. Mantenga el cable lejos de superficies calientes.

-No desenchufe tirando del cable. Para desconectar, sujete el enchufe, no del cable.

-No maneje el enchufe ni el aparato con las manos mojadas.

-No coloque ningún objeto en las aberturas. No lo use con ninguna abertura bloqueada; manténgala libre de polvo, pelusa, cabello o cualquier cosa que pueda reducir el flujo de aire.

-Mantenga el cabello, ropa suelta, dedos y todas las partes del cuerpo lejos de aberturas y piezas móviles.

-Apague todos los mandos antes de desenchufarla.

-Tenga mucho cuidado al limpiar las escaleras.

-No lo use para recoger líquidos inflamables o combustibles, como gasolina, ni lo use en áreas donde puedan estar presentes.

-Conectar a una toma de tierra adecuada. Vea las instrucciones de conexión a tierra.

-No recoja nada que esté ardiendo o humeando, como cigarrillos, fósforos o cenizas calientes.

-No la use sin la bolsa y / o filtros en su lugar.

GUARDE ESTAS INSTRUCCIONES

IMPORTANTES MESURES DE SÉCURITÉ

L'utilisation d'un appareil électrique demande certaines précautions, dont les suivantes:

LIRE TOUTES LES INSTRUCTIONS AVANT D'UTILISER (CET APPAREIL)

Pour un usage commercial uniquement.

AVERTISSEMENT – Pour réduire le risque d'incendie, de choc électrique ou de blessure:

-Ne pas laisser l'appareil sans surveillance lorsqu'il est branché. Le débrancher lorsqu'il n'est pas utilisé et avant le dépannage.

AVERTISSEMENT – Pour réduire le risque de choc électrique - Ne pas utiliser à l'extérieur ou sur des surfaces humides.

AVERTISSEMENT – Pour réduire le risque d'incendie ou de choc électrique Appliance utilisation seulement avec un cordon d'alimentation n° Partie NSS 9697271. Si le cordon est endommagé ou perdu, remplacez-le par la partie # 9697271.

-Ne pas laisser les enfants jouer avec l'appareil ou s'en servir sans surveillance. Redoubler d'attention s'il y a des enfants à proximité lorsqu'on utilise l'appareil.

-Utiliser l'appareil en respectant les consignes de cette notice d'emploi et n'utiliser que les accessoires recommandés par le fabricant.

-Ne pas utiliser l'appareil si le cordon ou la fiche est endommagé. Retourner l'appareil à un atelier de réparation s'il ne fonctionne pas normalement, s'il a été échappé, s'il est endommagé, s'il a été oublié à l'extérieur ou immergé.

-Le cordon ne doit pas être utilisé comme une poignée ou pour tirer, traîner ou soulever l'appareil. Ne pas faire passer l'appareil sur le cordon ; ne pas coincer le cordon dans l'embrasure en refermant les portes ni tirer dessus à l'angle d'un mur ou d'une autre arête vive et le tenir à distance des surfaces chaudes.

-Ne pas tirer sur le cordon pour débrancher l'appareil; tirer plutôt sur la fiche.

-Ne pas toucher la fiche du cordon ou l'appareil avec les mains humides.

-Ne pas insérer d'objet dans une ouverture quelconque de l'appareil. Ne pas utiliser l'appareil lorsqu'une ouverture est bloquée et enlever la poussière, la peluche, les cheveux, etc., qui peuvent gêner le débit d'air.

-Veiller à bien se garder – doigts, cheveux, vêtements amples – à distance des ouvertures et des pièces mobiles.

-Mettre toutes les commandes en position d'arrêt avant de débrancher l'appareil.

-Redoubler d'attention en nettoyant les escaliers.

-Ne pas se servir de l'appareil pour aspirer des liquides combustibles ou inflammables comme de l'essence ou dans un endroit où il peut y avoir de tels liquides.

CONSERVER CES INSTRUCTIONS

GROUNDING INSTRUCTIONS

This appliance must be grounded. If it should malfunction or breakdown, grounding provides a path of least resistance for electric current to reduce the risk of electric shock. This appliance is equipped with a cord having an equipment-grounding conductor and grounding plug. The plug must be inserted into an appropriate outlet that is properly installed and grounded in accordance with all local codes and ordinances.

WARNING – Improper connection of the equipment-grounding conductor can result in a risk of electric shock. Check with a qualified electrician or service person if you are in doubt as to whether the outlet is properly grounded. Do not modify the plug provided with the appliance – if it will not fit the outlet, have a proper outlet installed by a qualified electrician.

This appliance is for use on a nominal 120-V circuit, and has a grounded plug that looks like the plug illustrated in Figure 1 below. A temporary adaptor that looks like the adaptor illustrated in Figure 2 may be used to connect this plug to a 2-pole receptacle as shown in Figure 2 if a properly grounded outlet is not available.

The temporary adaptor should be used only until a properly grounded outlet (Figure 1) can be installed by a qualified electrician. The green colored rigid ear, lug, or the like extending from the adaptor must be connected to a permanent ground such as a properly grounded outlet box cover. Whenever the adaptor is used, it must be held in place by a metal screw.

Use of a temporary adaptor is not permitted in Canada.

INSTRUCCIONES DE CONEXIÓN A TIERRA

Este aparato debe ser conectado a tierra. Caso de mal funcionamiento o avería, la conexión a tierra proporciona un camino de menor resistencia para la corriente eléctrica para reducir el riesgo de descarga eléctrica. Este aparato está equipado con un cable que tiene un conductor de puesta a tierra y conexión a tierra. El enchufe debe insertarse en un tomacorriente apropiado que esté correctamente instalado y conectado a tierra de acuerdo con todos los códigos y ordenanzas locales.

ADVERTENCIA - La conexión inadecuada del conductor de tierra puede resultar en un riesgo de descarga eléctrica. Consulte con un electricista calificado o personal de servicio si tiene alguna duda en cuanto a si el enchufe está correctamente conectado a tierra. No modifique el enchufe suministrado con el aparato - si no encaja en el tomacorriente, haga instalar un tomacorriente adecuado por un electricista calificado.

Este aparato es para uso en un nominal de 120 V del circuito, y tiene un enchufe a tierra que se parece al enchufe ilustrado en la Figura 1. Un adaptador temporal que se parece al adaptador ilustrado en la Figura 2 se puede usar para conectar este enchufe a un receptáculo de 2 polos, como se muestra en la Figura 2, si una toma de tierra no está disponible.

El adaptador temporal debe utilizarse solamente hasta que una toma de tierra (Figura 1) puede ser instalado por un electricista calificado. El verde de la oreja rígida de color, oreja, o similares, que se extiende desde el adaptador debe estar conectado a una toma de tierra permanente, como una caja eléctrica de tierra. Cada vez que el adaptador se utiliza, debe ser mantenido en su lugar por un tornillo metálico.

El uso de un adaptador temporal no está permitido en Canadá.

INSTRUCTIONS DE MISE À LA TERRE

Cet appareil doit être mis à la terre. En cas de défaillance ou de panne, le circuit de mise à la terre offre au courant un chemin de moindre résistance qui réduit le risque de choc électrique. L'appareil est pourvu d'un cordon muni d'un conducteur qui en assure la mise à la terre et d'une fiche avec broche de terre. Cette fiche doit être branchée sur une prise convenable, correctement installée et reliée à la terre conformément aux codes et aux règlements du lieu.

AVERTISSEMENT. Un conducteur de terre mal raccordé présente des risques de choc électrique. Consulter un électricien ou un technicien d'entretien compétent en cas de doute à propos de la mise à la terre d'une prise quelconque. Ne pas modifier la fiche vendue avec l'appareil; si elle ne s'insère pas dans la prise, faire installer une nouvelle prise par un électricien compétent.

Cet appareil est pour utilisation sur un nominal de 120

V circuit, et dispose d'une prise de terre qui ressemble à la fiche illustrée à la figure 1 ci-dessous. Un adaptateur temporaire qui ressemble à l'adaptateur illustré à la figure 2 peut être utilisé pour raccorder cette fiche à une prise à 2 pôles comme le montre la figure 2, si une prise correctement mise à la terre n'est pas disponible.

L'adaptateur temporaire ne doit être utilisé que jusqu'à une prise correctement mise à la terre (figure 1) peut être installé par un électricien qualifié. Le vert oreille rigide de couleur, patte, ou similaire s'étendant à partir de l'adaptateur doit être connecté à une terre permanente, comme un couvercle de la boîte de sortie mise à la terre. Chaque fois que l'adaptateur est utilisé, il doit être maintenu en place par une vis en métal.

Utilisation d'un adaptateur temporaire n'est pas autorisée au Canada.

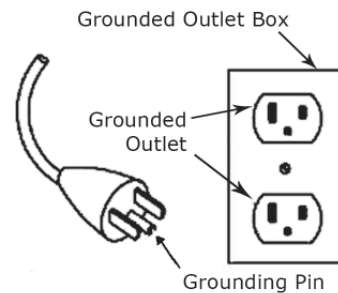

Figure 1

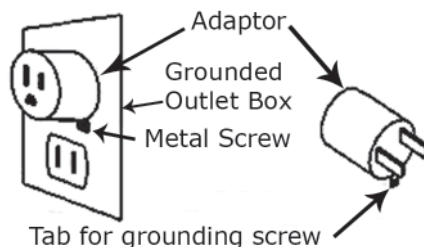

Figure 2 (grounded outlet box)

120V (nominal) MODELS

9600121 PACER 12UE 120V 50/60HZ

9600151 PACER 15UE 120V 50/60HZ

TABLE OF CONTENTS

1 Installation
Instructions

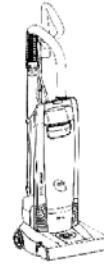
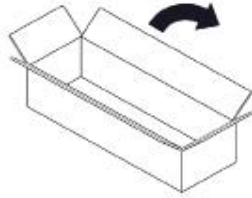

p2

2 Operating
Instructions

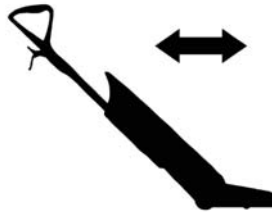

p4

3 User-Maintenance
Instructions



p6

4 Replacement
Parts

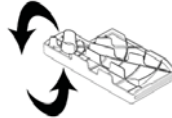

p9

5 Specifications

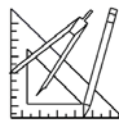

p10

1 Installation Instructions

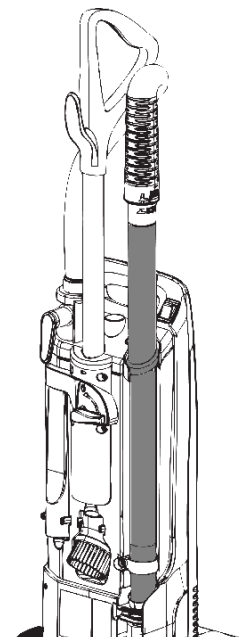
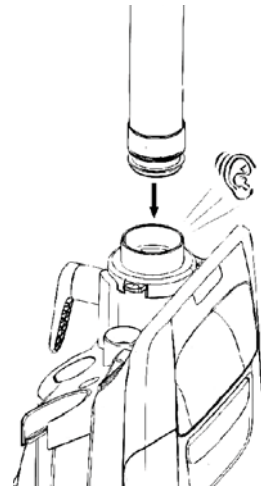
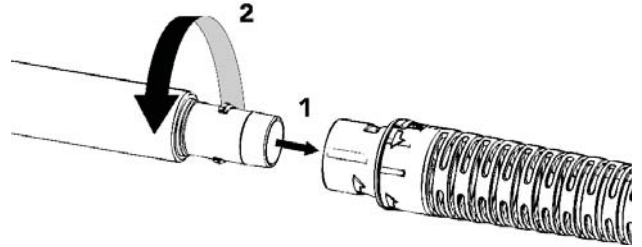
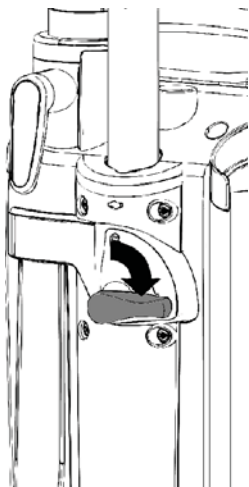
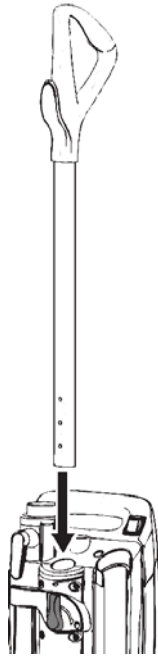
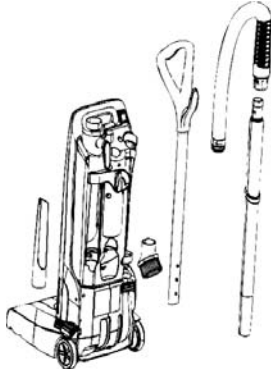
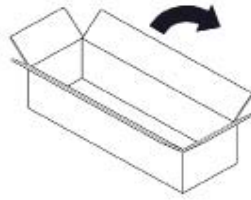

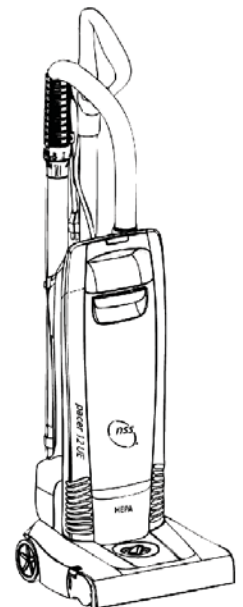
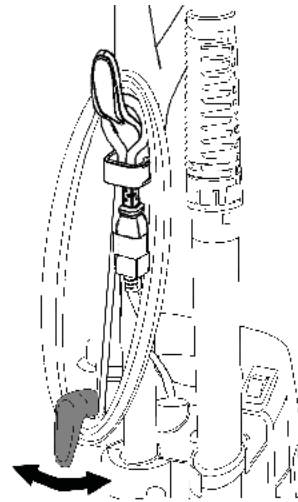
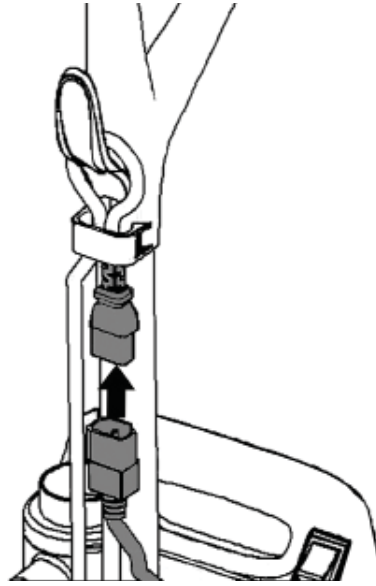
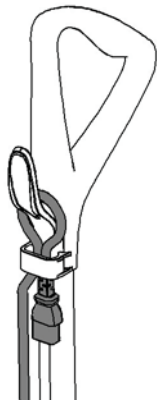
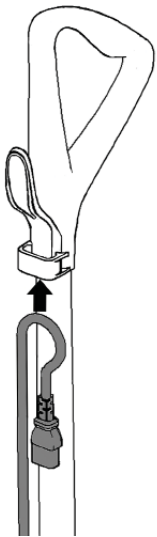
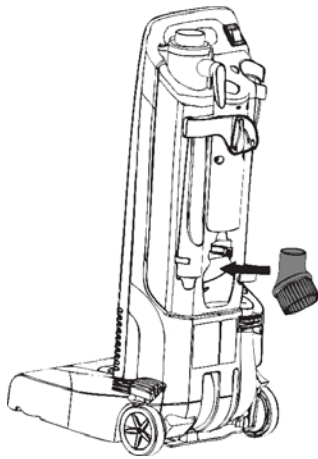
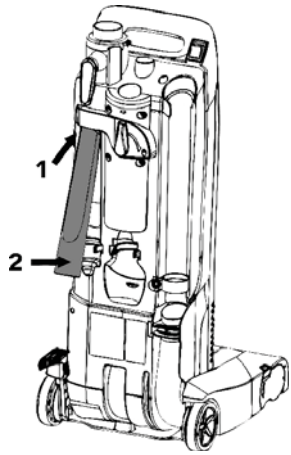

2 Operating Instructions

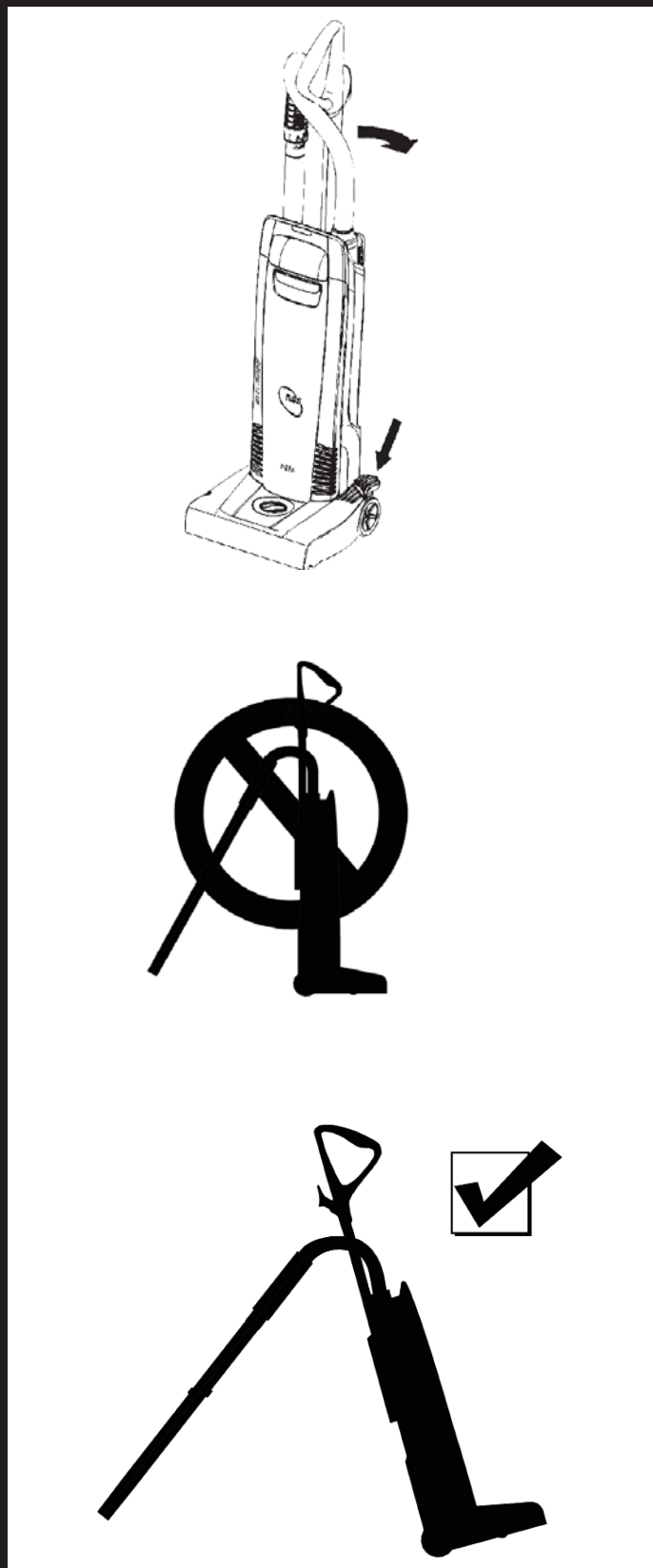
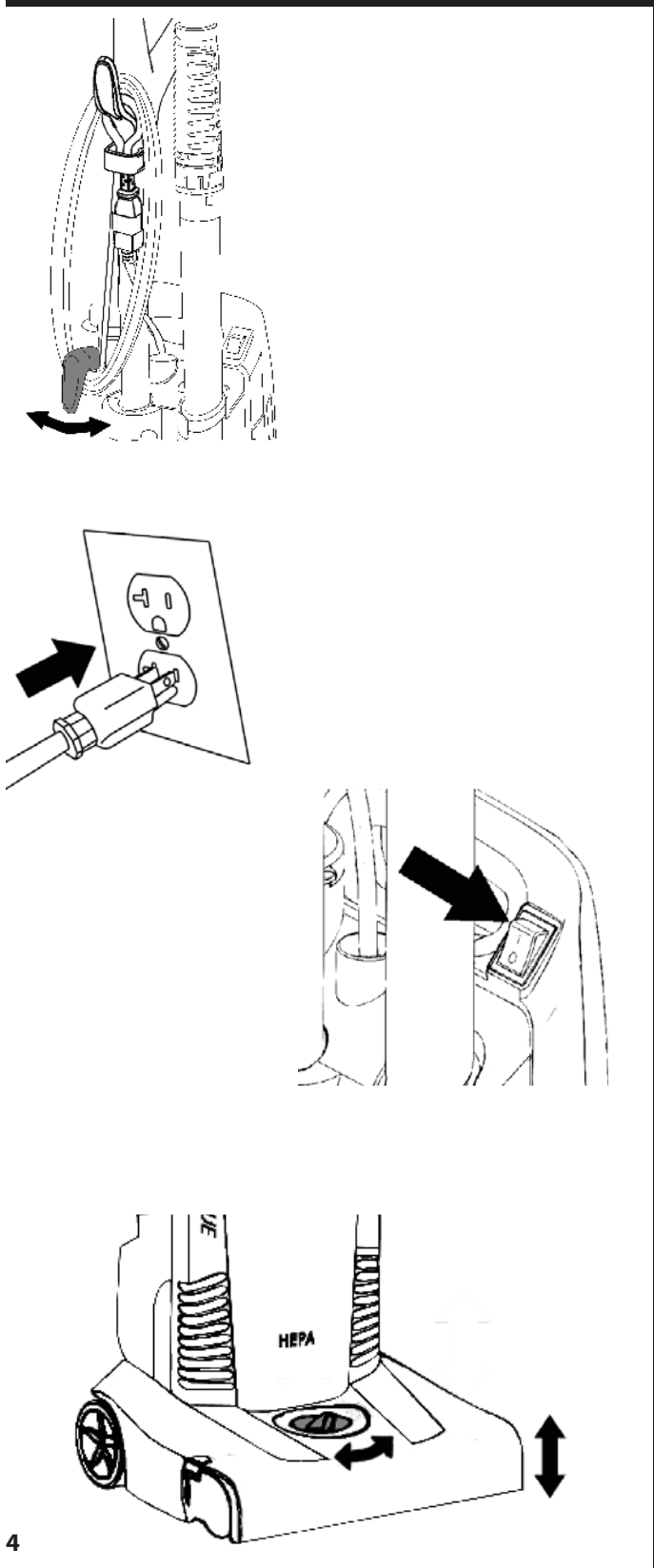
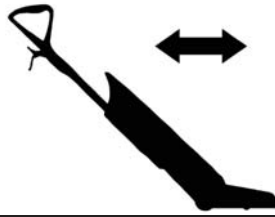

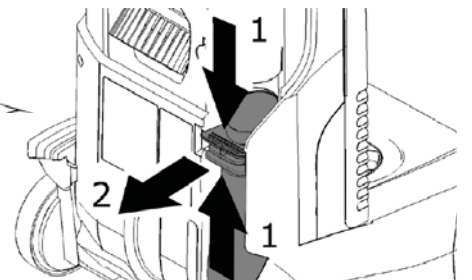
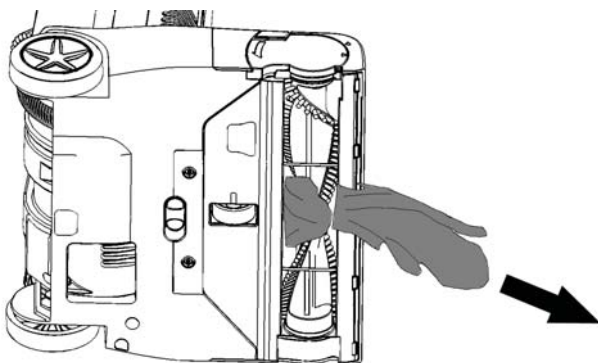
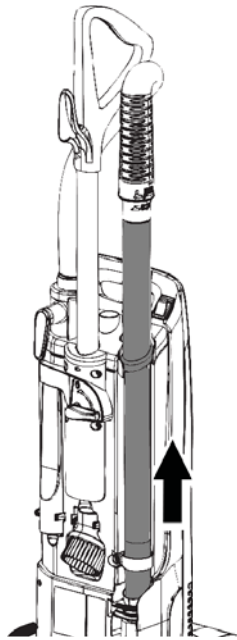
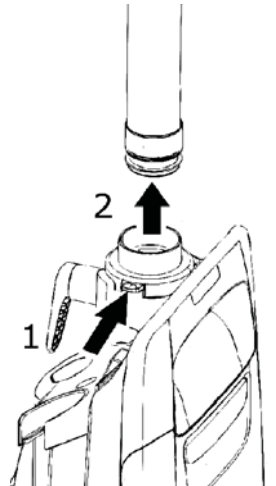
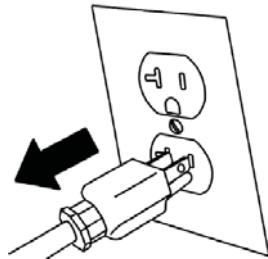
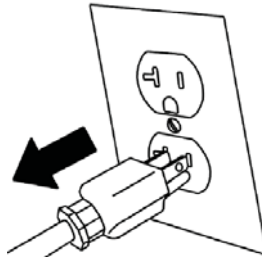
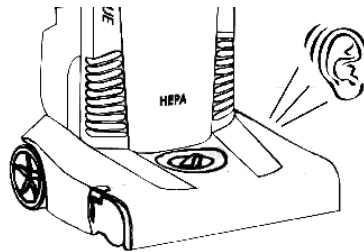
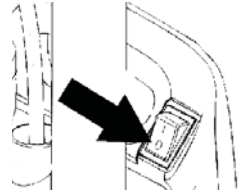
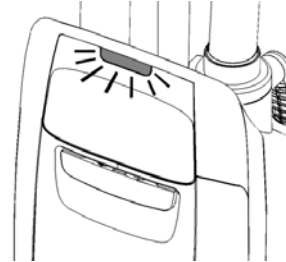
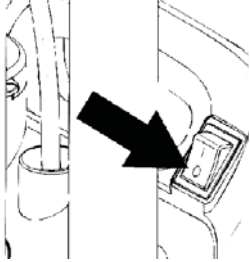
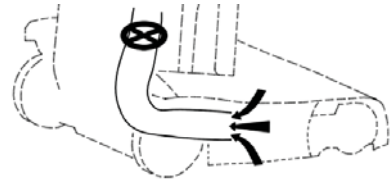
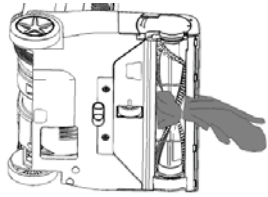

3 User-Maintenance Instructions-User Servicing

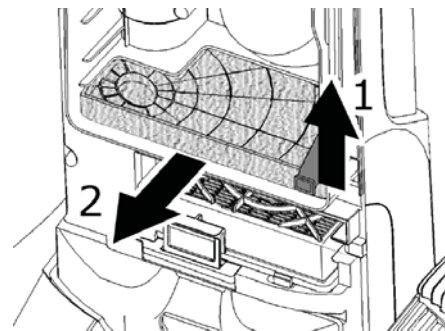
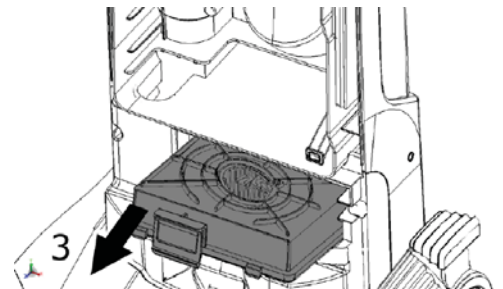
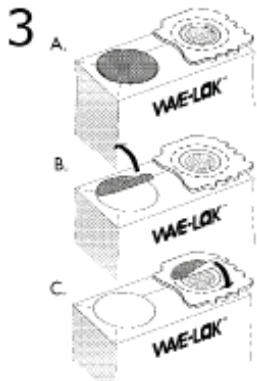
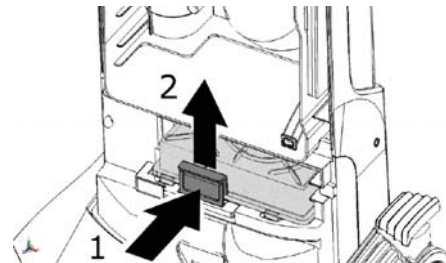
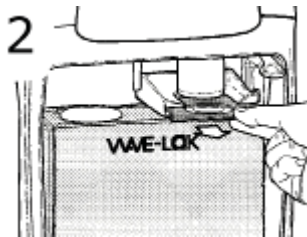
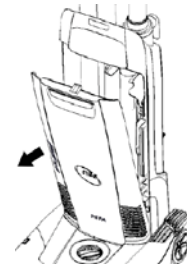
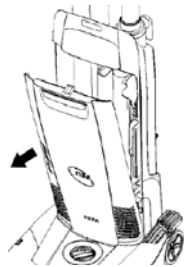
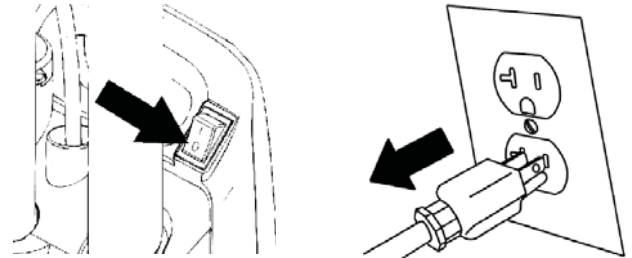
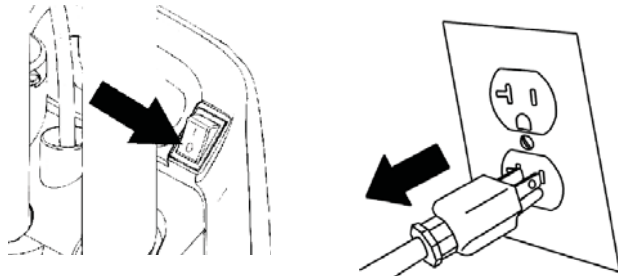
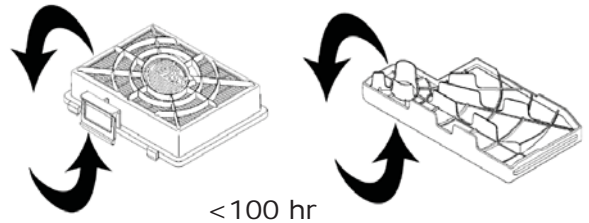
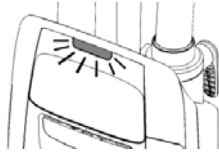

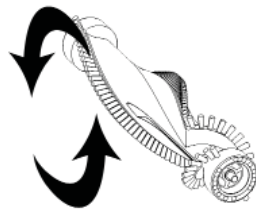

500 hr

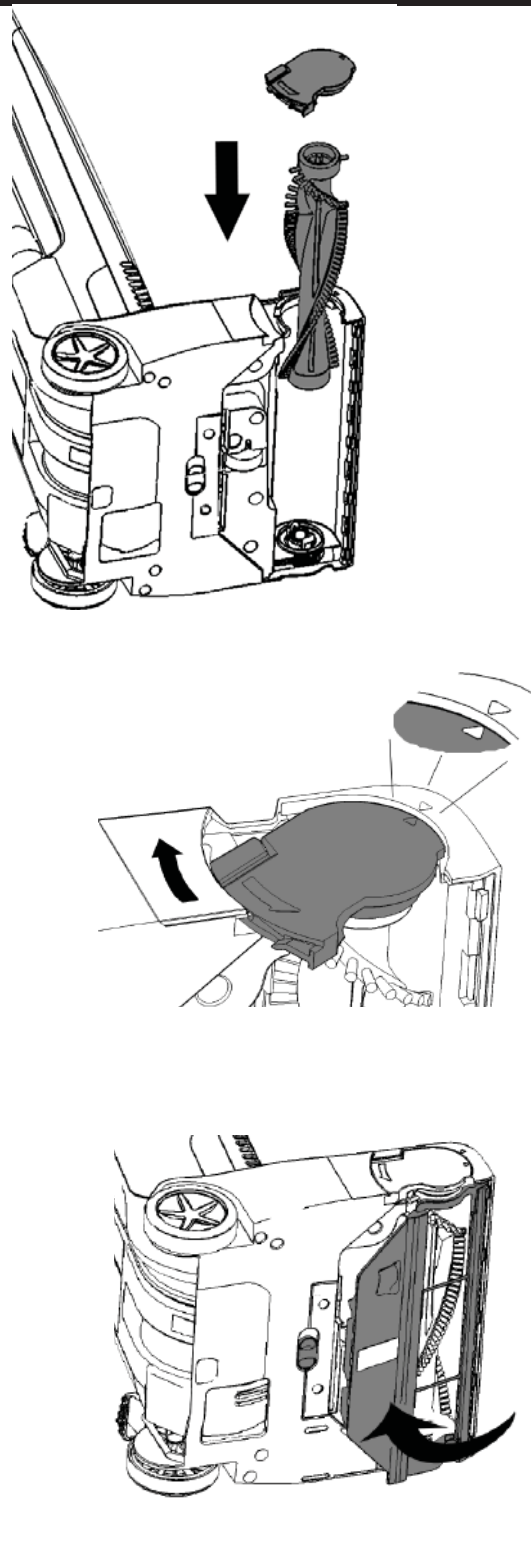
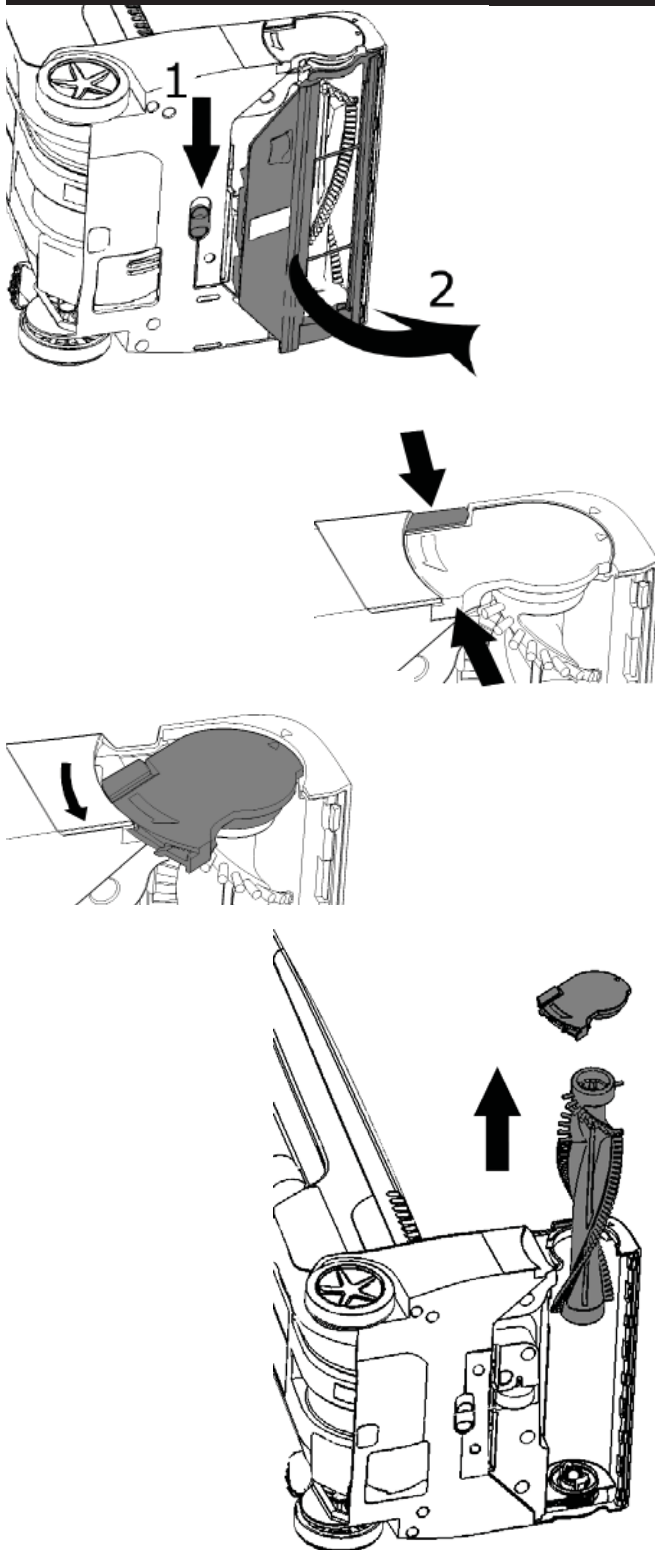

Any other servicing should be performed by an authorized NSS Service Representative.

User-Maintenance Instructions - Storage

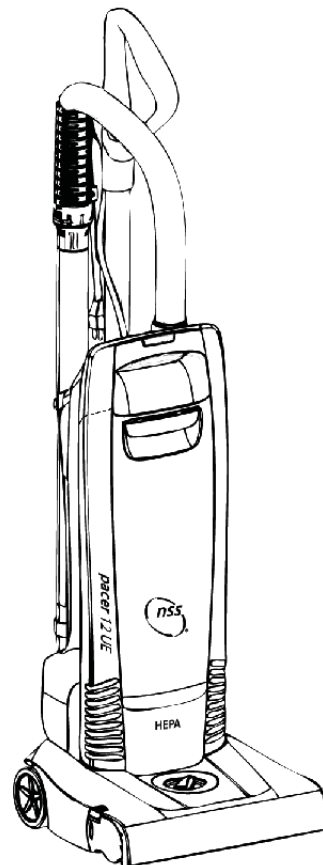
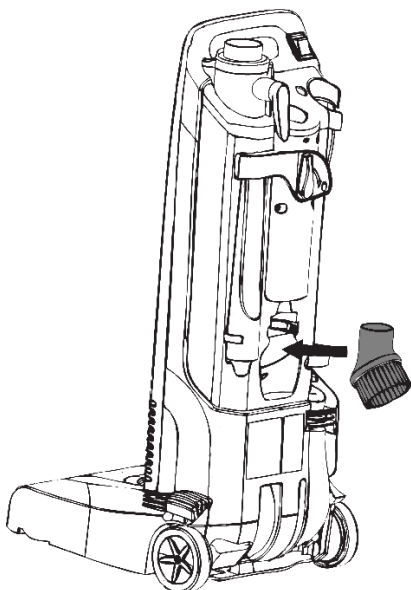
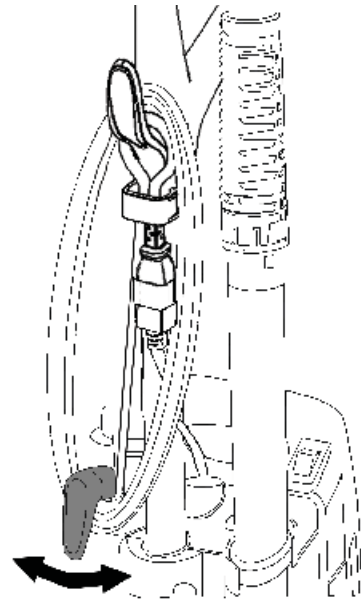
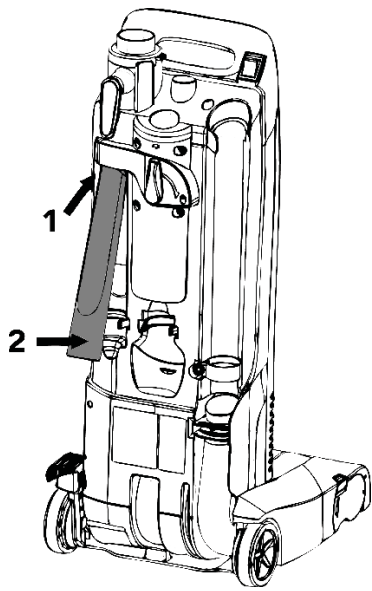

4

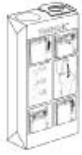

NSS #9691911 (10x)
**OPTIONAL REUS-
ABLE CLOTH BAG**
NSS #9694871



NSS #9690051

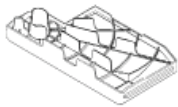

NSS #9690741



NSS #9697271 120 V



NSS #9690261 (12")
NSS #9693171 (15")



NSS #9690731



NSS #9690101



NSS #9690181



NSS #9690061

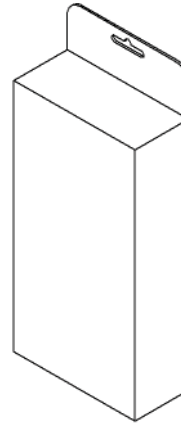

NSS #9694801
(INCLUDES:)









NSS #9691911 (10x)
NSS #9690051
NSS #9690741

**For After Sales Service, contact your local
NSS Distributor.**

5



SPECIFICATIONS

		9600121	9600151
	V	120	120
	Hz	50/60	50/60
	W	1250	1250
	kPa (in H ₂ O)	22.5 (90)	22.5 (90)
	l/s (cfm)	52.8 (112)	52.8 (112)
	kg (lb)	8.2 (18)	8.6 (19)
	°C (°F)	40 (104)	40 (104)
	mm (in)	300 (12)	380 (15)
Electrical Protective Class		I	I
ISO 5349-1			
a _n	m/s ²	1.96	1.96
K _a	m/s ²	0.2	0.2
ISO 11201			
	dB(A)	67	67



NSS Enterprises, Inc.

3115 Frenchmens Road
Toledo, OH 43607-2958
USA

(800) 677-1663
(419) 531-3761

mailus@nss.com
www.nss.com