



CHARGER 2717 DB & Charger 2022 DB

IMPORTANT SAFETY INSTRUCTIONS



WARNING: Failure to observe these instructions can cause personal injury to machine operator or bystanders.



WARNING: Fire or explosion hazard. **NEVER** operate this machine in an explosive atmosphere (grain dust, flammable liquids or fumes, etc.).



WARNING: Fire or explosion hazard. **NEVER** use flammable liquids (gas, kerosene, solvents, or thinners) to clean or burnish floor.

WARNING: This product contains a chemical known to the state of California to cause cancer and birth defects or other reproductive harm.

INTENDED USE

NSS Burnishers are intended for commercial use, buffing and burnishing floors in an indoor environment. It is not intended for spray burnishing. NSS Burnishers are Twister Approved. NSS does not recommend using these machines for any other purpose.

FOR SAFETY

- **ALWAYS** read and understand all instructions before operating or servicing machine.
- **ALWAYS** use this machine **ONLY** as described in this manual.
- **NEVER** attempt to operate this machine unless you have been trained in its operation.
- **NEVER** allow an untrained person to operate this machine.
- **ALWAYS** operate this machine from the rear control panel, not from the side.
- **ALWAYS** turn off master switch when attaching or changing pads.
- **NEVER** attempt to operate this machine if it is not working properly or has been damaged in any manner.
- **NEVER** disconnect or modify any switches or safety devices (circuit breaker).
- **NEVER** drop or insert any object into any machine opening.
- **NEVER** operate this machine with any air opening blocked. Keep all air openings free of dust, lint, hair, etc.
- **NEVER** pick up anything that is burning or smoking, such as cigarettes, matches or hot ashes.
- **NEVER** allow this machine to be used as a toy. Close attention is necessary when used by or near children.
- **ALWAYS** wear clean tennis shoes or "non-slip" shoes. Leather soled shoes will be extremely slippery.
- **ALWAYS** keep face, fingers, hair or any other body part or loose clothing away from any machine opening or moving part (revolving pad driver).
- **ALWAYS** be sure that the ramp is secured to the vehicle before attempting to load / unload.
- **ALWAYS** use extreme caution when operating the machine on a ramp or loading / unloading this machine into or out of a truck / trailer. Use extreme caution if the ramp is wet, oily, or covered with cleaning chemicals.
- **NEVER** stop or turn the machine on a ramp or incline.
- **NEVER** attempt to climb a grade or operate this machine on a ramp or incline of more than 20 degrees.
- **ALWAYS** store this machine indoors in a dry, cool area.
- **NEVER** park or store the machine near a dock, on ramps, near a furnace, boiler, open flame, or other high heat source.
- **NEVER** spray this machine with water or any liquids.
- **NEVER** allow the battery charging plug to get wet or a short may occur.
- **NEVER** operate this machine when the battery charger is plugged in.
- **NEVER** operate the machine outdoors or allow machine to freeze.
- **NEVER** expose the machine to rain, snow, or extreme temperatures.
- **NEVER** store any items on the machine.

ALL REPAIR SERVICE MUST BE PERFORMED BY AN NSS AUTHORIZED DISTRIBUTOR / SERVICE STATION USING ONLY NSS ORIGINAL EQUIPMENT PARTS.

**ORIGINAL INSTRUCTIONS
SAVE THESE INSTRUCTIONS**



IMPORTANT SAFETY INSTRUCTIONS

BATTERY POWERED EQUIPMENT WITH ON BOARD CHARGERS



WARNING: Failure to observe these instructions can cause personal injury to machine operator or bystanders.



Read and understand all instructions before installing or charging batteries.



No smoking, open flames, or sparks while working with batteries.



Contains acid. Avoid contact



Poison. Causes severe burns. Avoid contact.



WARNING: Batteries emit hydrogen, which can cause fire or explosion. **NEVER** smoke, light a match, or cause a spark during operation or charging. **ALWAYS** charge in a well-ventilated area away from open flame.

GENERAL

- **ALWAYS** read and understand all instructions before installing or charging batteries.
- **NEVER** attempt to install or charge batteries unless you have been trained to do so.
- **NEVER** allow an untrained person to install or charge batteries.
- **ALWAYS** remove all jewelry when working on or near the batteries.
- **ALWAYS** turn off all switches during installation and service.
- **ALWAYS** disconnect the battery leads before performing any service or repair.
- **ALWAYS** wear eye protection, rubber gloves and protective clothing to avoid contact with battery acid.
- **NEVER** lay anything on top of batteries as arcing may occur.
- **IF CONTACT WITH BATTERY ACID OCCURS**, follow these instructions:
 - SKIN – rinse area with water.
 - EYES – Flush with water for 15 minutes.
 - INTERNAL – Drink water or milk. Follow with Milk of Magnesia, beaten egg or vegetable oil. Call a physician immediately.

BATTERY INSTALLATION

- **ALWAYS** use two people to install, as batteries are heavy.
- **ALWAYS** turn off all machine switches.
- **ALWAYS** position batteries as shown on the machine installation decal to maintain machine balance.
- **ALWAYS** connect batteries as shown on the machine installation decal to avoid shorting out the batteries and the electrical system.

BATTERY CHARGING

- **ALWAYS** read instructions on charger carefully.
- **ALWAYS** use the NSS supplied charger with proper voltage rating.

For lead acid batteries only, (does not apply to gel cell or maintenance free batteries).

- **ALWAYS** check to ensure the battery water level covers the battery plates before charging.
- **ALWAYS** check water level after charging and add distilled water if necessary to bring level to the bottom of the fill hole.
- **NEVER** overfill batteries as battery and machine damage may result.
- **ALWAYS** wipe any acid from the top of batteries using a soap solution.
- **ALWAYS** reattach caps to batteries. Do not charge with caps loose or removed.
- **ADD** only distilled water.

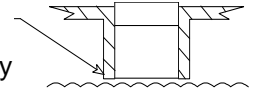

For All Types of Batteries

- **ALWAYS** study battery manufacturers' specific precautions such as recommended rates of charge.
- **NEVER** charge a frozen battery.
- **ALWAYS** plug the charger into an earthed socket-outlet.
- **NEVER** touch uninsulated portion of output connector or uninsulated battery terminal.
- **ALWAYS** disconnect the AC supply before making or breaking the connections to the battery while charging.
- **NEVER** open or disassemble charger.
- **NEVER** operate charger if the AC supply cord is damaged or if the charger has received a sharp blow, been dropped, or otherwise damaged in any way.

ALL REPAIR SERVICE MUST BE PERFORMED BY AN NSS AUTHORIZED DISTRIBUTOR/ SERVICE STATION USING ONLY NSS ORIGINAL EQUIPMENT PARTS

NOISE AND VIBRATION

NOISE

Sound pressure level at Operator position 68 dB(A)

VIBRATION

Weighted RMS acceleration value .269 m/s²
(ISO 5349)

MACHINE INSPECTION

- Now that the machine is unpacked remember to recycle all packing materials.
- Inspect the machine for damage or missing components. If damage is found, contact the freight company to file a freight claim.

MACHINE OPERATION

General Information

This machine works best with dry polishing or burnishing. Use mop on restorers rather than spray buff systems to restore the shine.

Spray buffing is time consuming and uses more pads because they become loaded with floor finish, which can cause overloading of the machine's control system.

Quick Start

Connecting Battery Pack to Machine



When the machine is shipped with batteries, the machine will arrive with the battery pack disconnected from the machine.

- Lift up on the handle on the top cover to expose the battery pack.
- Connect the cable with the Anderson connector into the Anderson connector mounted to the machine at the rear of the battery compartment in front of the control column.

For machines shipped without batteries

- See Battery Installation in the Maintenance Section later in this manual.

Lower Brush/Pad to Operating Position

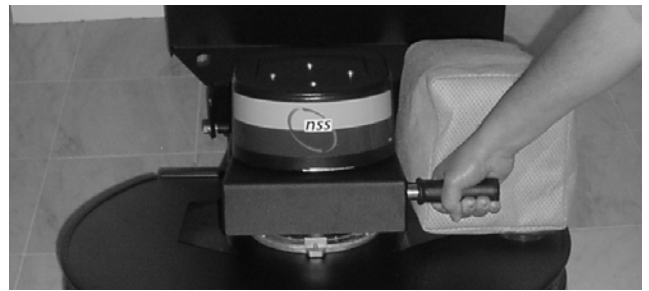

- Move the front of the machine from/to pad changing position or operating position by grasping the handle and moving it to the desired position.
- Turn on master switch (and key switch if so equipped). Wait until you hear a click, the machine is now on. See Machine Components for more information.
- Check that the battery meter is reading in the high or green range. The machine should be put on charge if not in the high range. See Charging Instructions later in this manual.
- Turn on brush switch. See Machine Components for more information.
- Twist the handle grips forward (away from you) to activate the Pad and Drive Motors. To move backward twist the handle grips backward (toward you). See Machine Components for more information.

CAUTION: This Machine must be moving at all times when the pad is rotating or the floor may be damaged.

Transporting the Machine to Work Site



NSS recommends transporting the machine to the work site with the front of the machine in the operating position and the brush switch in the off position. This will reduce the potential of damage to the Flexiwall Shield and Pad Driver when moving through stock/storage rooms and double swinging doors.

For questions and all information pertaining to this machine read the rest of this manual.

MACHINE COMPONENTS

Operator Control Column

The operator control column is located at the rear of the machine. This column has components that control various machine functions.

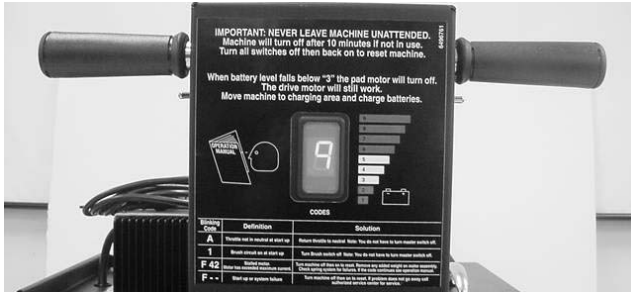

Drive System Control

- At the top on both sides of the control column are two (2) rubber twist grips. These grips rotate forward and backward to control the direction and speed of the machine.
- They also activate the Brush Motor so it is only on when the machine is moving. The farther the grips are rotated, the faster the machine will move.
- These twist grips have a safety feature that returns the machine to the neutral position when the handles are released.

Battery Meter

The battery meter is located in the back of the control column cover and has two uses. It shows the state of charge of batteries during operation and flashes fault codes when there is a problem with the machine.

- The rate of charge is indicated by numbers. The higher the number the greater the charge in the battery pack.
- When there is a fault with the machine, the Battery Meter will flash an "F" followed by a number.
- **See Trouble Shooting Chart for more information.**

Battery Charger



The battery charger is located on top of the battery box cover.

- This high efficiency battery charger is designed for onboard operation.



Master Switch

- The master switch is located on the top right side of the control column and it turns the machine on and off.
- If the brush switch is on and the brush head is down or the twist grips are not in the neutral position the machine will not turn on. A flashing fault code will appear on the battery meter. See the bottom of the decal on control column cover and correct the problem.
- The control system will automatically turn the machine off if it sets idle for 10 minutes. Turned off the master and brush switch and then turn the master switch back on to restart.

Hour Meter

- The hour meter is located under the Master Switch and counts the hours the brush motor is on. The hour meter is used for indicating maintenance intervals. The hour meter can not be reset.
- See maintenance section for maintenance intervals.

Fuse Holder

- The fuse holder is located under the Hour Meter. It houses a 2 AMP fuse.



Key Switch

- A Key Switch is Optional and will be located above the hour meter when installed. The key switch and master switch will both need to be used to turn the machine on and off.



Brush Switch

- The brush switch is located on the left side of the control column and it turns the brush on and off.
- There is also a tilt switch in this circuit located under the brush head that only allows the brush to be turned on when the brush head is in the operating position.

Circuit Breaker

- There is one master circuit breaker located below the brush switch on the control column.

Brush Head



- The brush motor, Filter Bag and Flexiwall shield are located at the front of the machine.
- The bag connects directly to the Flexiwall shield and has a snap that retains the rear of the bag.

MAINTENANCE

ALWAYS turn OFF all machine switches before performing any maintenance or repairs to any equipment.

Check the tension of the Drive Chain after the first 100 hrs of use and then every 90 days or 300 hours as needed. For the chain tightening instructions see the maintenance section called 90 Day Maintenance (300 Hours).

Daily Maintenance

Never leave the machine sit with a used pad installed. This can cause the pad driver to warp.

Pad Installation / Changing

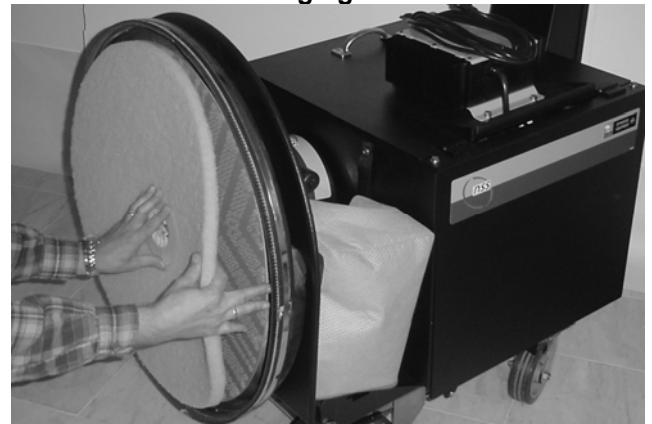

There is a wide range of pads available for many different burnishing applications. Consult your local NSS authorized distributor for application recommendations.

- Lift the front of the machine up to the 90 degree position to view the pad driver and pad.
- Make sure that the correct pad (7/8" to 1") X 27" is being installed.
- Place the pad flat on the floor, and remove the center hole of the pad, step on the center of the pad to compress the edges around the center hole. This allows for easier installation of the pad centering cup.
- With the machine in the pad changing position, carefully center the pad on the driver.

Caution: Pads must be installed concentric (evenly aligned) with the outside edge of the pad driver. Failure to follow these precautions will cause excessive machine vibration, a reduction in pad life and produce unsatisfactory burnishing results.

- Place the pad grabber in the center hole of the pad.
- Holding the pad driver and pad, push on the pad grabber until the spring clip has clicked twice.

Caution: Failure to install the pad grabber tightly may allow the pad to be thrown from the driver.

Daily Maintenance (continued)



- Empty the filter bag daily or when it is approximately one-half (1/2) full.

Charging Batteries



- Recharge the batteries when indicated by the Battery Meter.
- Never let the batteries sit overnight after the machine has been run for 1hr or more since last recharge.
- **NEVER** let the electrolyte level fall below the tops of the plates. This will damage the batteries immediately, and void the warrantee.
- Check charger cord for exposed wires and damaged plugs before using.
- To recharge the batteries plug the charger cord into the charger located on top of the machine and then into an electrical outlet.
- When the cord is plugged into an outlet the machine will automatically become disabled.
- Charge the batteries with the cover open when possible to reduce heat build up in the batteries.
- **See charging instructions for more details.**



- **ALWAYS** wear eye protection, rubber gloves and protective clothing to avoid contact with battery acid when working around batteries.
- After charging batteries check the water level of each battery cell and add distilled water as required to level specified by battery manufacturer.
- Check and verify that all battery connections are clean and tight.
- Wipe machine down with a damp cloth.
- **NEVER** spray this machine with water or any liquids.
- **ALWAYS** Check the tilt switch for proper operation. With the master switch turned off, put the brush head into the pad change position. Turn the brush switch on then the master switch on, the machine should turn on.
- If the machine does not turn on and the battery meter is flashing a one, the tilt switch has failed. **DO NOT** use the machine until the tilt switch has been replaced.

Opportunity Charging

Opportunity charging is charging the batteries when an opportunity presents itself, such as during breaks, and is done **in addition to a full charge cycle.**

Opportunity charging is recommended, as this extra charging time will help raise the operating voltage of the batteries, and will help ensure maximum runtime and cycle life.

See Monthly Maintenance and Operating Battery Charger Instructions for equalizing your batteries especially if you have been opportunity charging your machine.

Weekly Maintenance (Every 25 Hrs)

Verify all daily maintenance has been performed.



- Inspect the Flexiwall Shield for dents around the outside edge and cracks in the plastic.
- Check that the Brush and Retaining Band are properly installed.
- Remove dirt build up on the brush along the bottom of the Flexiwall Shield.
- A damaged Flexiwall Shield Assembly will greatly reduce dust control capabilities of the machine.

Monthly Maintenance (Every 100 Hrs)

Verify that all daily and weekly maintenance has been performed.

Equalize your batteries (Flooded only).

The batteries should be equalized once every 30 days for maximum battery runtime and life.

To equalize the batteries:

- Plug in the charger, and fully charge the batteries (until the green 100% LED is on continuously).
- Unplug the charger from the wall outlet, then plug it back in.
- The charger will run for 2hrs, holding the batteries at a constant voltage, and equalizing each cell.

THIS STEP IS ESPECIALLY IMPORTANT IF YOU PRACTICE OPPORTUNITY CHARGING.



- Check the Battery Tray Drain Hose for liquid level on a monthly basis.
- Spilled liquids from the battery compartment area are collected in a tray under the batteries. The tray can be drained using the hose at the right rear of the machine as shown above.
- **IMPORTANT:** Drain all liquids into an approved container and dispose of according to your local and federal regulations.



- Inspect the machine components for wear, loose fasteners, or damage. Pay special attention to all pivot points and moving parts.
- Call an authorized NSS service center for repairs.

90 Day Maintenance (Every 300 Hrs)

Verify that all daily, weekly and monthly maintenance has been performed.

Tighten Chain

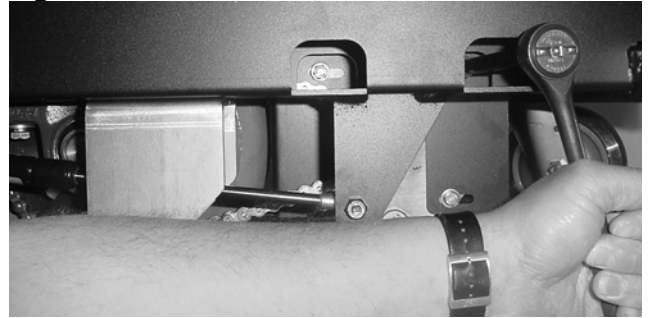

- Check the tension on the drive motor chain. If the chain has more than 1/2" deflection, tighten as needed.
- Access to the bolts for the drive motor are on the left side of the machine. There are two bolts on top which are accessed through the holes as shown in the picture above. There are also two bolts located below the frame. A total of four bolts.

Lubrication



- Lubricate the casters with an industrial grade bearing grease. Failure to lubricate casters will cause the machine to maneuver with difficulty and premature failure of the caster will result.

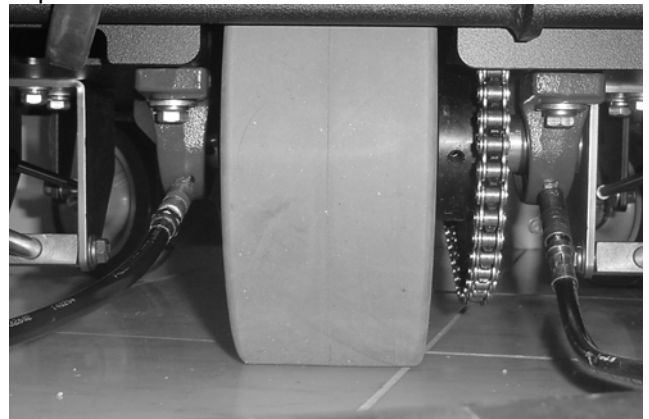

- Lubricate the drive wheel bearings with an industrial grade bearing grease. The zerk fittings

on the bearings can be accessed from the front of the machine.

- Failure to lubricate drive wheel bearings will cause the machine to maneuver with difficulty and premature failure of the bearings will result.



- Lube the drive motor chain with a small amount of grease using a brush. A chain spray can also be used.
- **NEVER** use your fingers to put the lube on the chain. **Serious injury may occur.**

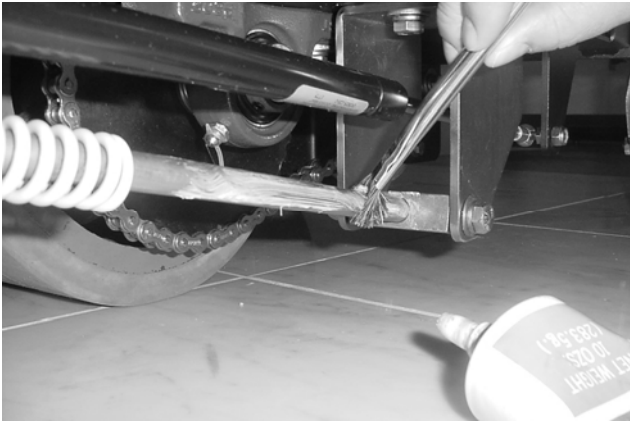

- Lubricate all moving parts as required with a small amount of grease.
- **DO NOT** lubricate the Gas Spring shaft, it does not require lubrication as it is self lubricating.

Every 6 Months (Every 600 Hours)

Call your Authorized NSS Distributor / Service Station to have the following services performed.

Verify that all daily, weekly, monthly and quarterly maintenance has been performed.

Inspect Brush Motor carbon brushes for wear.



- Using compressed air, blow the accumulated carbon brush dust out of the motor.
- Replace carbon brush when they measure $\frac{1}{2}$ " or less in length.
- Failure to replace carbon brushes will cause poor machine performance and possible motor damage.

Check the condition of the batteries.

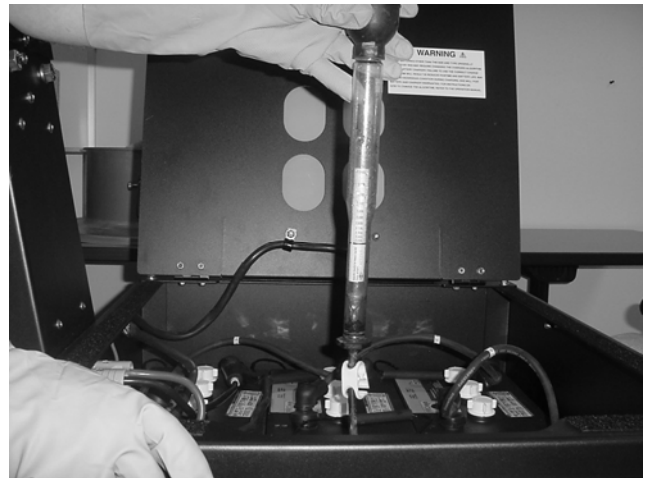

- A battery may be checked using a Hydrometer to check the specific gravity (strength) of the acid in each cell. Variations in readings occur due to the chemical reaction taking place during use.
- Always check the specific gravity when the battery is fully charged.
- Replace batteries as needed.

Battery Installation:

- Turn off all switches. Disconnect battery pack from the machine.
- **ALWAYS** wear eye protection, rubber gloves and protective clothing to avoid contact with battery acid when installing batteries. See Battery Warnings on page 2.

Repairs performed by an unauthorized company will void the machine warranty. If you require assistance finding an authorized service center, contact NSS Enterprises.



- Remove the side panel and top cover. There are two bolts (one in each corner) on top of the side panel and two nuts (one in each corner) at the bottom of the cover. Note that the nuts at the bottom are not visible from the side.



- The cover will still be attached to the side panel. Move them out of the way to install the Batteries.
- Batteries are heavy – **ALWAYS** use two people to install batteries into machine.
- Refer to wiring diagram located on the under side of the cover. Align batteries in compartment the same as the old batteries or as shown on diagram.
- Install battery cables the same as they were on the old batteries or as shown on wiring diagram located on the under side of the cover.
- **NSS** recommends replacing the battery cables when replacing batteries.
- Tighten bolts and hex nuts with a wrench.
- Install terminal boots over terminals to complete installation.

CAUTION: Do not short across two terminals with a wrench.

CAUTION: Loose or improper battery connections will cause battery or machine damage and possible personal injury.

Every 12 Months (Every 1200 Hours)

Call your Authorized NSS distributor / Service Station to have the following services performed. Verify that all daily, weekly, monthly and quarterly maintenance has been performed.

Inspect Drive Motor carbon brushes for wear.

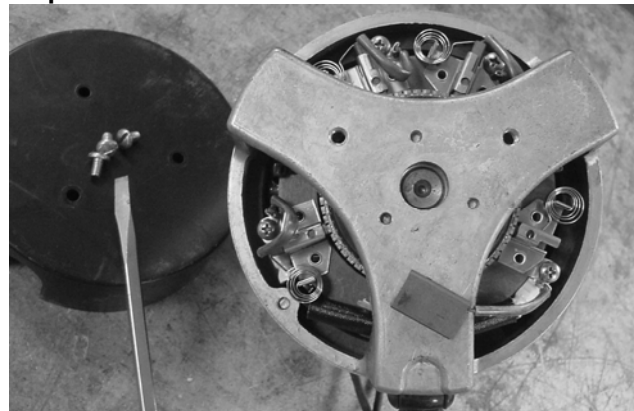

- This will require removing the drive motor from the machine and should only be done by an authorized NSS Service Station.
- Using compressed air, blow the accumulated carbon brush dust out of the motor.
- Replace carbon brush when they measure $\frac{1}{2}$ " or less in length.
- Failure to replace carbon brushes will cause poor machine performance and possible motor damage.

Gas Spring Service

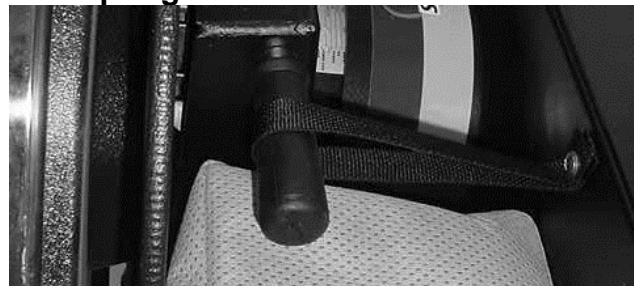

ALWAYS secure Brush Head in the pad change position using the strap provided before attempting any maintenance or repairs to the gas spring or coil spring assemblies.



- Remove the spring clip that secures the gas spring to the machine. Then pull the gas spring off of the ball stud. There is a clip and ball stud at each end.

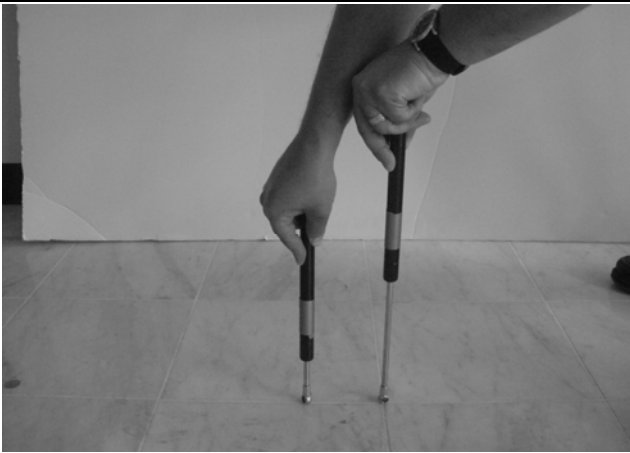

- Place one end of the gas spring against a hard surface and push on it. If you can compress it, it must be replaced. If you can not compress it, it is most likely OK.

Pad Pressure Adjustment

The NSS Charger 2717 DB and Charger 2022 DB is preset at the factory for medium duty applications. It can be tuned to your specific application for optimum performance.

ONLY an authorized NSS Service Station should perform this adjustment.

Tools required for Pad pressure adjustment

- 1) $\frac{3}{4}$ open end wrench
- 2) Clamp on Amp Meter



- It is necessary to use a clamp on AMP Meter when adjusting the pad pressure.
- There are many different manufactures and models of AMP Meters to choose from. Two AMP Meters are shown above. The one on the left is AMPROBE Model ACDC-610 and the one on the left is AMPROBE Model ACDC-400.

Checking the Pad Motor Amperage



- First install a new pad on the pad driver. **Caution:** Checking the Amps with a used pad will cause the machine to have high amps when a new pad is installed.
- Lower the Pad Motor into the operating position and open the cover over the battery compartment.
- Put the clamp on AMP Meter around the red (positive) wire coming from the battery pack to the machine as shown.
- While running the machine read the amp meter. The amp meter should be reading between 70-80 amps for the Charger 2717 DB & 50-70 amps for the Charger 2022 DB.

Pad Pressure Adjustment



If adjustment is required, follow these instructions.

- It will be easier to access the lock nut and spring guide rod assembly with the machine in the pad change position.
- First loosen the lock nut on the spring guide. With the lock nut loose, the spring guide rod assembly will be easily turned by grasping the set collar on the spring guide rod.
- Turn the spring rod guide assembly $\frac{1}{2}$ to 1 turn at a time. A little adjustment goes a long way.

- Thread the spring guide rod assembly out of the ball joint to decrease the pad pressure. Thread the spring guide rod assembly into the ball joint to increase the pad pressure.
- Every time an adjustment is made check the amps. This may require a few tries to get it where it should be.
- After the adjustment is made tighten the lock nut and redo the amp test. If it has not changed the process is complete.

Fall back setting ☺

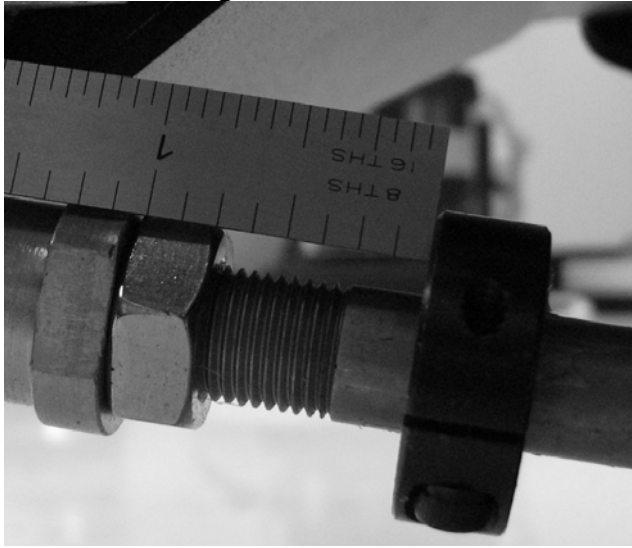

If your machine has come totally out of adjustment, or you need to replace the Spring Rod Guide Assembly you may need to start from the beginning.

- The factory starting setting for the pad pressure on the Charger 2717 DB is 3/4 of an inch from the set collar to the lock nut.
- The factory starting setting for the pad pressure on the Charger 2022 DB is 1/2 of an inch from the set collar to the lock nut.
- From this setting, proceed with the Pad Pressure Adjusted.

Battery Replacement Notes

- Entire Pack.
 - It is always recommended to replace all batteries in the pack at the same time.
- One or more batteries out of the pack. This is not recommended. Replacing just one or two batteries out of the pack can lead to the following:
 - Overcharging the new, or the remaining original, batteries.
 - Undercharging the new, or remaining original, batteries.

- Over discharging either the new or the remaining original batteries.
- If you wish to only replace some of the batteries in the pack, follow these steps for best results:
 - Replacement batteries must always be of the same battery manufacturer, model and amp-hour rating, as the remaining batteries in the pack.
 - Never mix batteries from different manufacturers in the same pack.
 - Fully charge both the new battery, and the remaining original batteries. (s.g. = 1.265 minimum, use a hydrometer)
 - Use a replacement battery that is close to the same age as the remaining original ones.
 - Do not run the machine as long for about 20 cycles. For example, if you used to get 4 hrs runtime, only run it for 2.5 hrs, and then charge the batteries completely.
 - Opportunity charge whenever possible.
 - Equalize after 30 days (**Flooded only**).
 - The above steps will provide the best opportunity for the new battery(s) to join the pack.

Battery Do's and Don'ts:

- a. You do not have to fully discharge the batteries before charging. They do not have a "memory".
- b. Plug the charger in anytime the machine is not in use.
- c. NEVER let the electrolyte level fall below the tops of the plates (flooded cell batteries). This will damage your batteries almost immediately, and void the battery warranty. They can tell if this happened.
- d. NEVER refill the batteries with well or tap water (flooded cell batteries).
- e. NEVER overfill the batteries (flooded cell batteries).
- f. NEVER let the batteries sit discharged overnight (or between shifts).
- g. ALWAYS check the electrolyte level about every 3 or 4 charge/discharge cycles BEFORE CHARGING.
- h. ALWAYS refill the batteries with distilled water (if needed) AFTER CHARGING.
- i. ALWAYS fully recharge the batteries after use (until the green LED comes on).
- j. ALWAYS equalize the batteries (**Flooded only**) every 30 days.
- k. NEVER OVER DISCHARGE!
- l. NEVER charge GEL batteries with the charger set to FLOODED/AGM.
- m. NEVER charge FLOODED/AGM batteries with the charger set to GEL. **EXCEPTION-TROJAN AGM'S TO BE CHARGED WITH GEL SETTING.**

Battery charger

The onboard battery charger supplied with this machine is capable of charging lead acid batteries from 185 to 350ah capacity. There is no need to change algorithms or settings based on battery manufacturer, or battery size.

The charger can also be set to charge flooded (wet) cell, AGM, or Gel batteries. LED's on the charger indicate which type of battery the charger is set to charge. One setting is for Flooded and AGM batteries, the other setting is only for GEL batteries.

Depending on the battery charger model, the charger can operate on 100/115/230 VAC 1ph 50/60 HZ power, and will automatically detect these input voltages. Before connecting the battery charger to power, check the label on the battery charger to verify proper input power.

Determining Your Battery Type

CAUTION: DIFFERENT BATTERY TYPES HAVE DIFFERENT CHARGING REQUIREMENTS. FAILURE TO PROPERLY IDENTIFY YOUR BATTERY TYPE, AND SET THE CHARGER ACCORDINGLY WILL RESULT IN BATTERY DAMAGE, AND VOID THE WARRANTY.

Your machine may have been ordered with batteries installed at the NSS factory. The standard battery type, normally supplied by NSS, is the Flooded (wet) cell lead acid battery. Gel and AGM sealed batteries may also be available at customer request.

Flooded (wet) batteries can be easily identified by the removable cell caps. Removing the caps allows inspection of the liquid electrolyte (sulfuric acid) level in each cell.

AGM (Absorbed Glass Mat) batteries are sealed, maintenance free batteries. They do not have cell

caps intended for removal. Look for **“AGM”** printed on the tops or sides of the batteries.

Gel (gelled electrolyte) batteries are also sealed, maintenance free batteries. They do not have cell caps intended for removal. Look for **“GEL”** printed on the tops or sides of the batteries.

Battery Charger Indicator LED's

Your battery charger is equipped with LEDs that indicate the following:

- **Battery Type Setting.** Either of these two LEDs will be illuminated, anytime the charger is plugged in, to signal which type(s) of batteries the charger is configured to charge. The two options available are:
 - Wet / AGM: When this LED is illuminated, the charger is configured to charge either flooded (wet), or AGM batteries.
 - Gel Cell. When this LED is illuminated, the charger is configured to charge Gel batteries ONLY. **EXCEPTION: Trojan AGMs are to be charged with the Gel setting.**
- **State of Charge Indicators.** Four additional LEDs provide information about the charge level of the batteries during charging.
 - 30%, 60%, 90% and 100%.
- **Fault Indications.** During charging, the charger provides feedback about the charge process and any problems detected. It will provide feedback and signal the type of problem by flashing LEDs as described below:

Wet/AGM (Amber)	Gel Cell (Amber)	30 (Red)	60 (Red)	90 (Red)	100 (Green)	Meaning
On	Off					Charger is set for Wet/AGM batteries.
Off	On					Charger is set for Gel batteries.
One light on*	On	On	Off	Off	Off	Charger cycle is in process - bulk stage
One light on*	On	On	On	Off	Off	Charger cycle is in process - bulk stage
One light on*	On	On	On	On	Off	Charger cycle is in process - absorption stage
One light flashing*	Off	Off	Off	Off	Flashing	Charger nearing the end of the charge cycle.
One light on*	Off	Off	Off	Off	On	Charge cycle is complete.
One light on*	Flashing	Off	Off	Off	Flashing	Damaged battery detected. One or more batteries failed to complete the charge cycle. Check battery water levels. Batteries can be used, but will not provide full run time.
One light on**	Flashing	Off	Off	Off	Off	No batteries detected. Check that the battery pack is plugged into the machine. Check wiring.
One light on*	Flashing	Flashing	Off	Off	Off	Batteries failed to climb above 1.74 volts per cell within the first three hours of charging. The batteries are damaged and will need to be replaced.
One light on*	Off	Flashing	Flashing	Off	Off	Charge cycle time out. The charge cycle did not finish in the allowed time. Check the battery water levels. Unplug the charger and plug it back in. Allow the batteries to charge again. If the code is repeated, then it is likely that the batteries are damaged.
One light on*	Flashing	Flashing	Flashing	Off	Off	Charge cycle time out. The charge cycle did not finish in the allowed time. Check the battery water levels. Unplug the charger and plug it back in. Allow the batteries to charge again. If the code is repeated, then it is likely that the batteries are damaged.
One light on*	On	Off	On	Off	Off	Internal over temperature. The charger's internal temperature exceeded the maximum permitted. If possible, move the machine to a cooler location. Unplug the charger and plug it back in. Allow the batteries to charge again.

* The light that is on depends on the charger configuration (Wet/AGM or Gel Cell)

** The light (Wet/AGM or Gel Cell) will only stay on for two seconds

Changing the Battery Type Setting

The standard setting for the onboard battery charger is Flooded/AGM. **EXCEPTION:** If your machine was ordered from NSS equipped with Gel batteries, then the charger was configured for Gel batteries at the factory.

Configuring the Charger for Gel batteries:

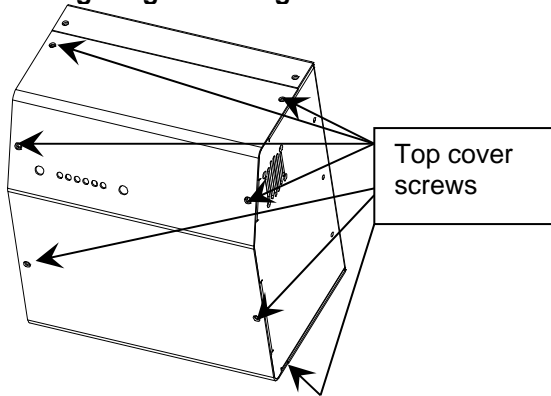

1. Remove the top cover.
2. Pull the jumper off the board (position 1), and then store the jumper for later use at position 2. See photo below.
3. Reinstall the top cover.

1. The green wire outputs a battery voltage when the charger is not plugged in to AC to provide an Interlock function.
2. Securely fasten the black ring terminal from the charger to the negative terminal ("-", "NEG", "NEGATIVE") of the battery pack.
3. Select Charge Algorithm if battery type is other than factory default.

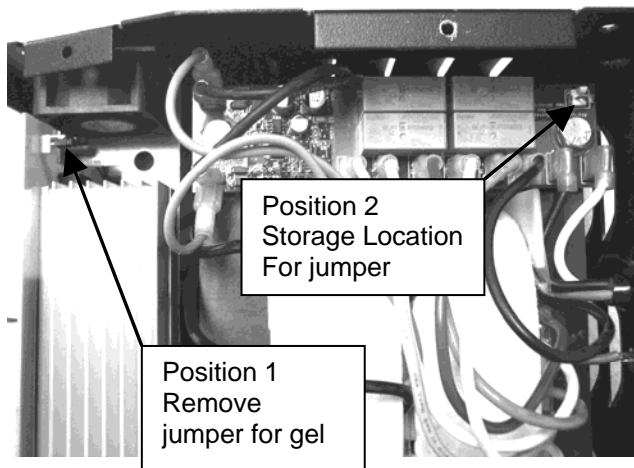

Configure the Charger for Flooded/AGM batteries

1. Remove the top cover
2. Pull the jumper from the storage location (position 2), and install the jumper at position 1.
3. Reinstall the top cover.

Operating the Battery Charger

CAUTION: DIFFERENT BATTERY TYPES HAVE DIFFERENT CHARGING REQUIREMENTS. FAILURE TO PROPERLY IDENTIFY YOUR BATTERY TYPE AND SET THE CHARGER ACCORDINGLY WILL RESULT IN BATTERY DAMAGE, AND VOID THE WARRANTY.

The battery charger is fully automatic. Simply plug the charger into a suitable wall outlet, and the charger will charge the batteries. The green 100% LED will be continuously illuminated when the charge cycle is complete.

A bubbling, or boiling sound coming from the batteries during the last few hours of the charge is normal. The batteries may be warm, but not too hot to touch.

The charger will maintain the proper battery voltage as long as it is plugged in (maintenance mode).

Equalizing the batteries (Flooded only)

The batteries should be equalized once every 30 days for maximum battery runtime and life.

To equalize the batteries:

- Plug in the charger, and fully charge the batteries (until the green 100% LED is on continuously).
- Unplug the charger from the wall outlet, then plug it back in.

The charger will run for 2hrs, holding the batteries at a constant voltage, and equalizing each cell.

Opportunity Charging

Opportunity charging is charging the batteries when an opportunity presents itself, such as during breaks, and is done **in addition to a full charge cycle**.

Opportunity charging is recommended, as this extra charging time will help raise the operating voltage of the batteries, and will help ensure maximum runtime and cycle life.

See Operating Battery Charger Instructions or Monthly Maintenance for equalizing your batteries especially if you have been opportunity charging your machine.

**TABLE 1
BATTERY TYPES**

NSS Part Number	Crown Part Number	Battery Volts	System Volts	Amp Hour	Battery Type Setting
4491061	1-1470	12	36	210	Flooded/AGM
3390361	1-1435	6	24 & 36	235	Flooded/AGM
2392111	1-1427	12	24	115	SPE CURVE 0
6393651	1-1428	12	24	145	SPE CURVE 0
2392731	1-12145	12	24	100	SPE CURVE 1
6491931	1-1437	6	24 & 36	200	GEL
2691501	1-1450	6	36	350	Flooded/AGM

NOTE: Trojan AGM batteries should be charged with the GEL setting.

The charger has been tested on batteries from the following manufacturers:

- Trojan flooded cell
- US Battery flooded cell
- Deka flooded cell
- Crown gel
- Concord gel
- Discover AGM

TROUBLE SHOOTING CHART

Problem	Cause	Solution
Machine will not turn on.	Battery pack is not plugged into machine.	Open the battery cover and plug the battery pack into the machine.
	Battery charger is plugged into AC outlet.	Unplug the battery charger.
	The 4 amp fuse is missing or blown.	Replace 4 amp fuse.
	Circuit breaker is tripped.	Reset circuit breaker.
Brush motor will not run or stopped running.	Current over load of brush motor has exceeded set parameters in control system.	Turn off all switches and then turn on the master switch to reset the control system. If the problem continues check battery meter for fault code F42.
	Tilt switch failure.	Check tilt switch operation. Replace tilt switch if test failed.
	Carbon Brushes worn or not making contact.	Have an authorized NSS Service Station check carbon brushes and replace if necessary.
Brush motor will not turn off when handles are in neutral position.	The potentiometer is set on the threshold of neutral or potentiometer has failed.	Have an authorized NSS Service Station reset the potentiometer to neutral or replace.
Machine vibrates.	Pad not centered or torn.	Center pad. Change torn and worn pad.
	Pad driver damaged and/or out of balance.	Check pad driver for damage and replace if necessary.
Run time is less than when new.	Damaged or defective battery or battery pack.	Check for fault codes on the battery charger during battery charging. Have an authorized NSS Service Station check the batteries and replace as necessary.
	Batteries are not fully charged	Charge batteries until the green LED indicates the charge cycle is complete.
	Incorrect Battery Type Setting on the charger	Ensure the charger is set according to the type of batteries installed.
Battery charger will not turn on.	Battery charger cord damaged.	Check for cord damage and replace if necessary. DO NOT try to repair it.
	Connection not made between battery charger and battery pack.	Check connections at battery pack for corrosion and loose or broken wires.
	The battery charger is damaged.	Have an authorized NSS Service Station check and replace if necessary. DO NOT try to repair it.

TROUBLE SHOOTING CHART CONTINUED

Problem	Cause	Solution
Pad will not stay in the pad change position.	Weak or missing gas spring(s).	Check and replace if necessary.
Pad will turn on in the pad changing position.	Tilt switch failure.	See daily maintenance for proper checking procedure. Replace tilt switch as necessary.
Circuit breaker trips.	Spray Buffing.	DO NOT spray buff.
	Pad pressure too heavy.	Check gas springs for failure and replace as necessary.
	Pad pressure collars out of adjustment.	Readjust pad pressure collars as required by your burnishing conditions.
Front of machine does not move down to the floor when turned on.	Spring guides sticking in slides.	Check spring guides for proper operation. Replace if bent. Lubricate if necessary. Loosen bolts in spring guide mounting bracket, it will self align, retighten bolts.
Flashing number 1 appears in battery meter.	Brush motor circuit closed when machine is turned on.	Turn off brush switch. Check tilt switch for proper operation.
Flashing letter A appears in battery meter.	Twist grip not in neutral when master switch is turned on. Potentiometer not set properly in neutral position.	Let go of twist grip. Have an authorized NSS Service Station reset the potentiometer to neutral or replace.
Fault code F12 appears in battery meter.	Internal programmable parameter data is corrupt.	Turn machine off and then on. If problem continues call for service.
Fault code F23 appears in battery meter.	Internal temperature of controller has exceeded the set parameters.	Turn machine off and let control system cool off. If problem continues call for service.
Fault code F26 appears in battery meter.	Precharge failure when controller is turned on or the control system has been miswired causing an internal controller failure.	Turn machine off and then on. If problem continues call for service.
Fault code F29 appears in battery meter.	Wired incorrectly. Internal control system failure.	Check wiring. Turn machine off and then on. If problem continues call for service.
Fault code F32 appears in battery meter.	Wired incorrectly. Internal control system failure.	Check wiring. Turn machine off and then on. If problem continues call for service.
Fault code F37 appears in battery meter.	Potentiometer wired incorrectly. Internal control system failure.	Check wiring. Turn machine off and then on. If problem continues call for service.
Fault code F42 appears in battery meter.	The brush motor is exceeding the current limit set in the controller.	Check the gas springs for wear. Check the brush pressure set collars for proper adjustment. Check pad driver and Flexiwall shield for proper installation and problems. Turn machine off and then on. If problem continues call for service.
Fault code F44/F4C/F45/F59/F60 appears in battery meter.	Caused by wiring short circuit in drive wiring or shorted drive motor.	Check wiring and drive motor for short circuit. Correct problem if found. If problem continues call authorized NSS Service Station for service.
Fault code F4D/F46/F61 appears in battery meter.	Caused by wiring short circuit in brush wiring or shorted brush motor.	Check wiring and brush motor for short circuit. Correct problem if found. If problem continues call for service.
Fault code F58 appears in battery meter.	The deceleration of the brush motor or drive motor exceeded set parameters. Example: Tried to slow down or stop on too steep a hill.	Turn machine off and then on. If problem continues call authorized NSS Service Station for service.
Fault code F62 appears in battery meter.	Wired incorrectly. Internal control system failure.	Check wiring. Turn machine off and then on. If problem continues call for service.
Fault code F63 appears in battery meter.	Caused by wiring short circuit in contactor wiring or contactor coil.	Check wiring and contactor for short circuit. Correct problem if found. If problem continues call for service.

Repairs performed by an unauthorized company will void the machine warranty. If you require assistance finding an authorized service center, contact NSS Enterprises.

