

OPERATION MANUAL

WRANGLER 27/33

IMPORTANT SAFETY INSTRUCTIONS



WARNING: Failure to observe these instructions can cause personal injury to machine operator or bystanders.



WARNING: Fire or explosion hazard. **NEVER** operate this machine in an explosive atmosphere (grain dust, flammable liquids or fumes, etc.).



WARNING: Fire or explosion hazard. **NEVER** attempt to pick up flammable or combustible materials or use such materials in tank.

INTENDED USE

This machine is designed for scrubbing floors in an indoor environment. NSS does not recommend using this machine for any other purpose.

FOR SAFETY:

- **ALWAYS** read and understand all instructions before operating or servicing machine.
- **ALWAYS** use this machine **ONLY** as described in this manual.
- **NEVER** attempt to operate this machine unless you have been trained in its operation.
- **NEVER** allow an untrained person to operate this machine.
- **NEVER** attempt to operate this machine if it is not working properly or has been damaged in any manner.
- **NEVER** disconnect or modify any switches or safety devices (circuit breaker).
- **NEVER** drop or insert any object into any machine opening.
- **NEVER** operate this machine with any air opening blocked. Keep all air openings free of dust, lint, hair, etc.
- **NEVER** pick up anything that is burning or smoking, such as cigarettes, matches or hot ashes.
- **NEVER** spray this machine with water or any liquids.
- **NEVER** allow the vacuum motor or battery charging plug to get wet or a short may occur.
- **NEVER** operate this machine when the battery charger is plugged in.
- **NEVER** operate this machine with the side skirt removed.
- **NEVER** allow this machine to be used as a toy. Close attention is necessary when used by or near children.
- **ALWAYS** wear clean tennis shoes or "non-slip" shoes. Leather soled shoes will become extremely slippery when wet.
- **ALWAYS** keep face, fingers, hair or any other body part or loose clothing away from any machine opening or moving part (revolving brush, pad driver, or vacuum motor).
- **ALWAYS** turn the machine off when attaching pads or brushes.
- **ALWAYS** remove keys when this machine is left unattended.
- **ALWAYS** be sure that the ramp is secured to the vehicle before attempting to load/unload.
- **ALWAYS** use extreme caution when operating the machine on a ramp or loading/unloading this machine into or out of a truck/trailer. Use extreme caution if the ramp is wet, oily, or covered with cleaning chemicals.
- **NEVER** stop or turn the machine on a ramp or incline.
- **NEVER** attempt to climb a grade or operate this machine on a ramp or incline of more than 8 degrees.
- **NEVER** park or store the machine near a dock, on ramps, near a furnace, boiler, open flame, or other high heat source.
- **NEVER** allow this machine to freeze.
- **NEVER** expose the machine to rain, snow, or extreme temperatures.
- **NEVER** store any items on this machine.
- **ALWAYS** store this machine indoors in a dry, cool area.

ALL REPAIR SERVICE MUST BE PERFORMED BY AN NSS AUTHORIZED DISTRIBUTOR/ SERVICE STATION USING ONLY NSS ORIGINAL EQUIPMENT PARTS.

SAVE THESE INSTRUCTIONS



IMPORTANT SAFETY INSTRUCTIONS

BATTERY POWERED EQUIPMENT



WARNING: Failure to observe these instructions can cause personal injury to machine operator or bystanders.



Read and understand all instructions before installing or charging batteries.



No smoking, open flames, or sparks while working with batteries.



Contains acid. Avoid contact.



Poison. Causes severe burns. Avoid contact.



WARNING: Batteries emit hydrogen, which can cause fire or explosion. **NEVER** smoke, light a match, or cause a spark during operation or charging. **ALWAYS** charge in a well-ventilated area away from open flame.

GENERAL

- **ALWAYS** read and understand all instructions before installing or charging batteries.
- **NEVER** attempt to install or charge batteries unless you have been trained to do so.
- **NEVER** allow an untrained person to install or charge batteries.
- **ALWAYS** remove all jewelry when working on or near the batteries.
- **ALWAYS** turn off all switches during installation and service.
- **ALWAYS** disconnect the battery leads before performing any service or repair.
- **ALWAYS** wear eye protection and protective clothing to avoid contact with battery acid.
- **NEVER** lay anything on top of batteries as arcing may occur.
- **IF CONTACT WITH BATTERY ACID OCCURS**, follow these instructions:
 - SKIN – rinse area with water.
 - EYES – Flush with water for 15 minutes.
 - INTERNAL – Drink water or milk. Follow with Milk of Magnesia, beaten egg or vegetable oil. Call a physician immediately.

BATTERY INSTALLATION

- **ALWAYS** use two people to install, as batteries are heavy.
- **ALWAYS** turn off all machine switches.
- **ALWAYS** position batteries as shown on the machine installation decal to maintain machine balance.
- **ALWAYS** connect batteries as shown on the machine installation decal to avoid shorting out the batteries and the electrical system.

BATTERY CHARGING

- **ALWAYS** read instructions on charger carefully.
- **ALWAYS** use the NSS supplied charger with proper voltage rating.
- **ALWAYS** check to ensure the battery water level covers the battery plates before charging.
- **ALWAYS** check water level after charging and add water if necessary to bring level to the bottom of the fill hole.
- **NEVER** overfill batteries as battery and machine damage may result.
- **ALWAYS** wipe any acid from the top of batteries using a soap solution.

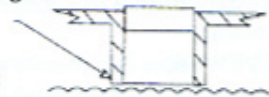

ALL REPAIR SERVICE MUST BE PERFORMED BY AN NSS AUTHORIZED DISTRIBUTOR/ SERVICE STATION USING ONLY NSS ORIGINAL EQUIPMENT PARTS.

SAVE THESE INSTRUCTIONS



NSS WRANGLER 27FB - 33FB VS

Variable Speed Automatic Scrubber

OPERATING INSTRUCTIONS

BASIC SAFETY PRECAUTIONS

- Always be sure to read and fully understand these safety, assembly, operating and maintenance instructions before attempting to operate this machine.
- Never allow anyone to operate this machine who has not been properly trained.
- Refer to the beginning of this book for the complete safety and electrical warnings.

MACHINE INSPECTION

- Carefully unpack the Wrangler 27 - 33 FB VS and recycle all packing materials.
- Inspect machine for damage or missing components. If damage is found, contact the local freight company to file a freight claim.

MACHINE COMPONENTS

Solution Tank

The solution tank is the lower part of the machine body and it has a capacity of **26 gallons**.

- The tank is filled by pouring the water and cleaning chemicals through the square opening and filter at the front of the tank.
- The amount of water in the tank is measured by the indicator strip in the clear plastic tube at the right rear corner of the tank.
- The solution tank is emptied through the clear plastic tube at the right rear corner of the tank.



Recovery Tank

The recovery tank is the upper part of the machine body and it has a capacity of **32 gallons**.

- The recovery tank is closed by a round, clearview lid assembly.



- The recovery tank has a foam sensitive float shut-off assembly. As the water level rises, the float ball will rise into the tube and shut off the air flow of the vacuum.

- The float shut-off assembly does **not** shut off the vacuum motor.



- The recovery tank is emptied through a large rubber hose at the front of the machine. Remove the plug and drain the liquids according to your local EPA regulations.

Operator Control Panel

The operator control panel is located at the upper rear area of the machine.

This panel has components that control various machine functions.

- In the middle of the panel are two (2) rubber twist grips. These grips rotate forward and backward to control the direction and speed of the machine. The farther the grips are rotated, the faster the machine will move. These twist grips have a "dead man" feature that returns the ma-



chine to the neutral position when the handles are released.

- The first toggle switch on the left turns on and off the brush motor.
- The next toggle switch turns on and off the vacuum motor.
- The square red button in the center is the master power switch and it controls the power to all components. Power ON is indicated by the green light.
- The battery meter shows the state of charge of the batteries during operation and recharge.

Battery Meter

The battery meter is located on the right side of the operator control panel. This meter indicates the condition of the batteries.

- Work Range - This is the green area in the middle of the meter. It shows the approximate amount of "power" available in the batteries. Observe this reading when operating the Wrangler.
- Recharge Range - This is the red area on the left of the meter. It shows when the batteries need to be recharged. Continued machine operation in this area will cause battery damage and potential machine damage.



- Charge Range - This is the red area on the right of the meter. It shows the approximate amount of recharging the batteries have received.

To observe this reading - turn on the master switch, observe the meter, turn off the master switch.

Solution Control (Valve) Lever

The solution control lever is located in front of the right hand twist grip. This lever controls the solution valve and the amount of liquids put on the floor when cleaning.



- Pull up on the handle to open the valve.
- Push down on the handle to close the valve.

Circuit Breaker and Lift Arm Panel

This is the vertical metal panel located at the rear of the machine.

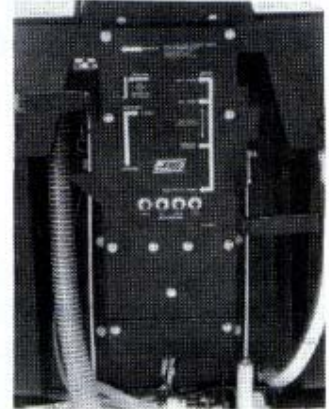

- The left circuit breaker is for the drive motor and is rated at 25 amps.
- The next circuit breaker is for the vacuum motor and is rated at 20 amps.
- The two circuit breakers on the right are for the brush motors and each is rated at 25 amps.
- The right lift arm is used to raise and lower the brush motor assembly.
- The left lift arm is used to raise and lower the squeegee assembly.

Battery Charging Plug

This plug is located below the left twist grip near the upper left corner of the circuit breaker and lift arm panel.

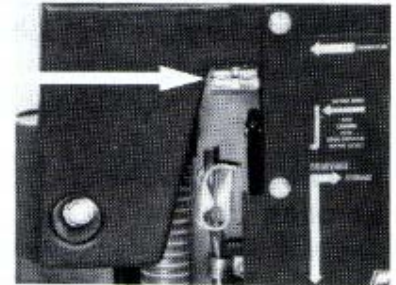

- The battery charger plug is inserted into the charging plug to recharge the batteries.
- This plug is gray on 36 volt machines.

Battery Compartment Drain Hose

This hose is located below the battery charging plug and behind the squeegee lift arm. The hose uses a pinch clamp to hold the hose closed. This hose collects any spilled liquids from the battery compartment area.

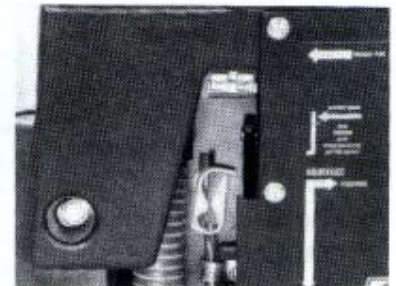

- Inspect hose for liquid level on a weekly basis.
- Dispose of liquids according to local your EPA regulations.

Solution Filter Assembly

Attached to the intake of the solution valve is a filter assembly designed to stop debris from entering the solution valve.

If water and chemical stops flowing:

- There is a metal filter screen inside the plastic collar fitting of the solution hose - open the collar fitting (by hand), remove and clean the screen.
- Replace screen in collar fitting and thread closed collar fitting (by hand). Check for any liquid leaks.

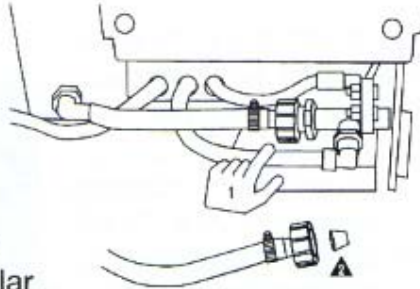
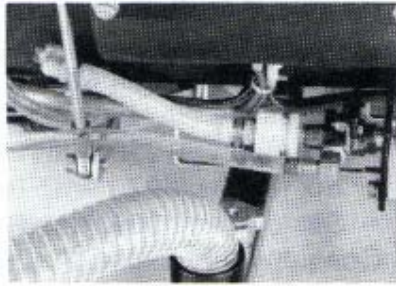

Drive Motor

This machine is powered forward and reverse by a 36 volt drive motor.

- The speed is electronically controlled for smooth increase and decrease of speed.
- The motor moves the drive wheel through a chain and sprocket system.
- This motor has carbon brushes that must be serviced on a regular basis. The carbon brushes have an expected life of 2,000 operating hours. Refer to the maintenance section later in this book.

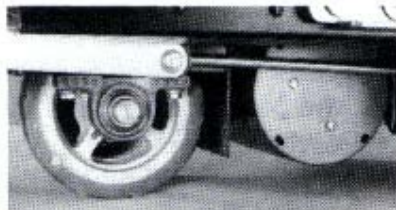

Brush Gear Motor

This machine has two (2) 36 volt brush motors located at the front of the machine.

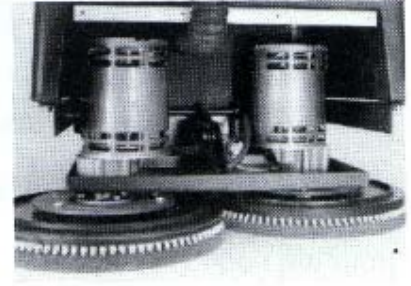

Note: Some machine parts have been removed for clarity.

- The motor is attached to a gearbox to turn the pad drivers or brushes.
- The left motor rotates clockwise.
- The right motor rotates counterclockwise.
- These motors have carbon brushes that must be serviced on a regular basis. The carbon brushes have an expected life of 2,000 operating hours. Refer to the maintenance section later in this book.

Vacuum Motor

This machine has a 36 volt vacuum motor.

- It is attached to the upper rear area of the recovery tank.
- This motor has carbon brushes that must be serviced on a regular basis. The carbon brushes have an expected life of 1,200 operating hours. Refer to the maintenance section later in this book.



Vacuum Motor Filter

This machine has a vacuum motor filter located under the metal plate on the top of the recovery tank. The filter is designed to prevent any foam in the recovery tank from entering the vacuum motor. Refer to the maintenance section later in this book.

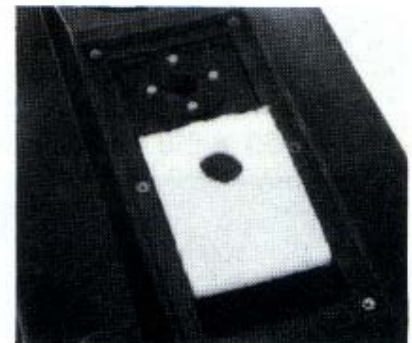

Squeegee Assembly

The squeegee assembly uses a dual (2) urethane blade system to recover liquids from the floor.

- The squeegee assembly has a wide, flat frame to help prevent damage, two (2) mounting knobs and two (2) small wheels to prevent "rollover" in reverse.
- The squeegee assembly mounts to a metal "U" shaped bracket at the bottom center of the machine.

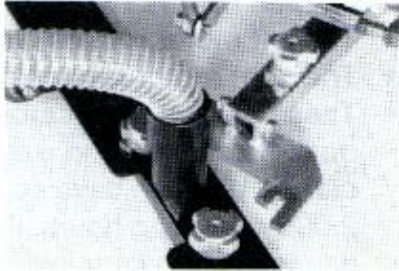
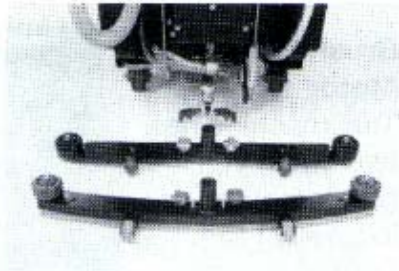

The Wrangler 27 - 33 FB VS may be equipped with an optional "curved" heavy duty squeegee assembly. Consult your local NSS authorized distributor for this accessory.

Side Skirt Assemblies

The machine is equipped with left and right side skirt assemblies.

- The side skirt assemblies are designed to contain the liquids in the cleaning area under the machine and channel them toward the squeegee and prevent splashing outside of the machine.
- The side skirt assemblies attach to the front of the machine with retaining pins and are secured at the side with a retaining latch.

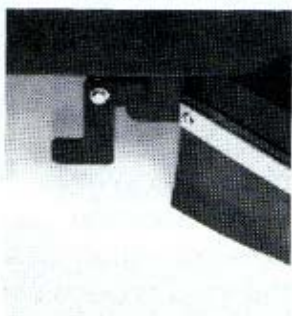

Battery Package

The Wrangler 27 - 33 FB VS is a 36 volt system and is available with three battery packages:

- Six (6) 6 volt 220 Amp Hour Batteries
- Six (6) 6 volt 270 Amp Hour Batteries
- Six (6) 6 volt 305 Amp Hour Batteries

Consult your local NSS authorized distributor for application recommendations.

To install the batteries:

- Turn off all switches and tilt open the recovery tank to expose battery compartment.
- Batteries are heavy - use two people to install.
- Refer to wiring diagram inside the battery compartment. Align batteries in compartment as shown on diagram.
- Install battery cables as shown on wiring diagram. Tighten bolts and hex nuts with a wrench.
- Loose or improper battery connections will cause battery or machine damage and possible personal injury.



MACHINE OPERATION

General Information

Always sweep the floor before scrubbing. You may also need to preclean some spills or stains before scrubbing. Consult your local NSS authorized distributor for procedures and more complete chemical advise.

Safety Precautions

- Never attempt to operate the machine when the battery charger is plugged in.
- Never leave machine unattended.
- Never turn machine on a ramp or incline.
- Never stop machine on a ramp or incline.
- Never store machine on a ramp or incline.
- Never attempt to operate machine on a ramp or incline of more than 20 degrees.
- Always secure loading ramp to dock or vehicle before attempting to load or unload.

- Never park or store machine near a furnace, boiler, open flame or other high heat source.
- Never allow machine to freeze.
- Never spray machine with water.
- Never store items on machine.
- Always wear clean "tennis shoes" or "non-slip shoes" when working with an automatic scrubber. Leather sole shoes of any type will be extremely slippery when wet.
- Make sure you wipe your shoes dry before walking onto other areas of bare floor or carpet. Some floor cleaning chemicals may cause great damage to carpet.

DAILY USE

The Wrangler 27 - 33 FB VS is very maneuverable and is designed to clean as you drive the machine from behind. Follow these steps to prepare the machine for daily operation.

Prepare the solution tank:

- Never use water over 140F (60 C) degrees.
- Excessively hot water may damage components such as the tanks.
- Pour all liquids through the round mesh filter at the front of the solution tank.
- Put 1 to 2 gallons of clean water into the solution tank first to help dilute the chemicals and prevent excess sudsing.
- Consult your local distributor for complete chemical advise. Dilute the cleaning chemicals according to the manufacturers instructions.
- Add the cleaning chemicals to the solution tank and fill with water as needed.



Prepare the recovery tank:

- Always use a defoamer to protect the vacuum motor of this machine. After each time you empty the recovery tank, we recommend that you add at least 4 to 6 ounces of defoamer chemical into the recovery tank before resuming work. Vacuum the defoamer into the recovery tank through the squeegee vac hose.
- Make sure the drain plug of the recovery tank hose is closed tightly and in its' holding clip.



To install a pad driver and pad:

- There are a wide range of pads or brushes available for the many cleaning applications of this machine. Consult your local NSS authorized distributor for application recommendations.
- Turn the pad drivers upside down on the floor and remove the pad holding cup (split ring).
- Remove the center cutout of the 14" pad (W27) or the 17" pad (W33). Place the pad on the face of the pad driver.
- The pad must be centered on the driver to prevent wobbling or bouncing.
- Install and secure the pad holding cup to the pad driver. Turn the



pad driver over so that the pad faces the floor.

- Raise the brush motors into the transport position.
- Align the lugs of the pad driver with the slots of the drive casting.
- Turn the lug of the pad driver toward the latch, close the latch around the lug to lock onto the drive casting.

To install a brush: *(Installed same as Pad Driver above)*

- Raise the brush motors into the transport position.
- Align the lugs of the brush with the slots of the drive casting.
- Turn the lug of the brush toward the latch, close the latch around the lug to lock onto the drive casting.

To install the squeegee assembly:

- Place the squeegee lift arm in the storage (up) position.
- Loosen the two mounting knobs and slide the squeegee assembly onto the mounting plate. The roller wheels must face the operator.
- Hand tighten the mounting knobs. Do not use pliers to tighten knobs as this will defeat the "breakaway" design.



To adjust the squeegee assembly:

As the machine is used, the squeegee blades will wear or need to be replaced due damage. Some adjustment may be needed.

- Turn the vacuum motor ON and open the water valve slightly.
- Squeegee blades should lay over slightly (like a window squeegee)

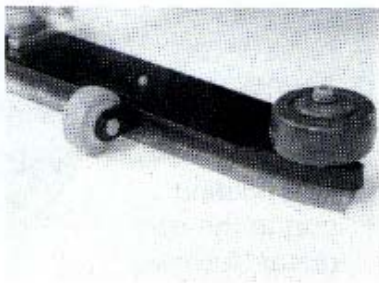

when the machine is moving forward or reverse.

- Adjust the blade angle by turning the wingnut (or knob) on the pivot arm clockwise or counterclockwise.
- Do not add any weights or other pressure to the squeegee mechanism, it will not improve the performance and will shorten service life.

To install the side skirts:

- Position the skirts at the left / right side of the machine.
- Remove the skirt retaining pins from the mount bracket.
- Align side skirt holes with mount bracket holes, insert and secure retaining pins.
- Close side skirts around machine and secure with skirt latch.

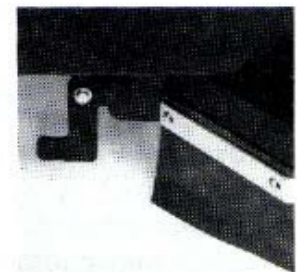

The side skirt wiper blades will naturally wear with use and require adjustment or replacement.

To adjust side skirt wiper blades:

- Install the side skirts on the machine:
- Loosen the retaining strip screws.
- Pull down evenly on entire length of wiper blade so that it firmly touches the floor.
- Tighten all screws and test run machine for liquid leaks.
- DO NOT adjust blades too low, it will cause damage and excessive wear to the blades.

To replace side skirt wiper blades:

- Remove the side skirt assembly from the machine.

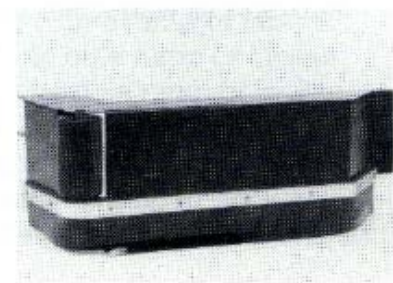

- Remove the retaining strip and screws.
- Remove the old wiper blade and replace with a new blade.
- Replace the retaining strip and screws, do not tighten. Pull down evenly on entire length of wiper blade so that it firmly touches the floor.
- Tighten all screws and test run machine for liquid splashing under the blades.
- DO NOT adjust blades too low, it will cause damage and excessive wear to the blades.

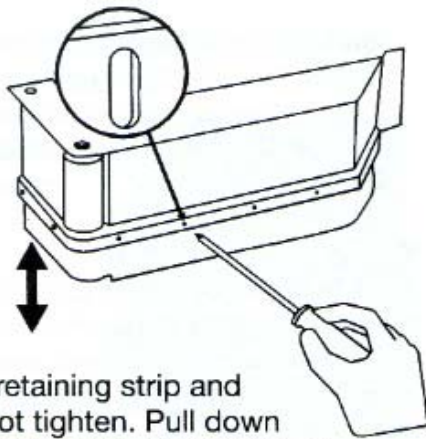

CLEANING PATH

The Wrangler 27 - 33FB VS has the brush motors offset to the right side of the machine. This offset allows you to clean the edge of the floor or obstructed areas (walls or shelving) with the right side of the machine.

- Sweep and dust mop the floor to remove dirt and debris before scrubbing. Accumulations of dirt or debris on the floor will reduce cleaning performance.
- Overlap each cleaning path about 2 in. (5cm.) to prevent streaking and dirty areas.

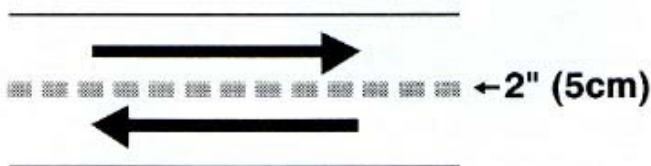

Normal Cleaning

- Fill solution tank as directed.
- Put defoamer chemical in recovery tank.
- Install pad drivers / pads or brushes.
- Close and secure side skirts.
- Install squeegee assembly.
- Move machine to area to be cleaned.
- Sweep and dust mop area to be cleaned.
- Place warning signs "Wet Floor" in area.
- Turn on master switch.
- Turn on brush and vacuum motor switches. Place brush motors and squeegee assem-

- bly in operating position on floor.
- Twist handle grips forward (away from you) to move forward and backward (toward you) to move backward.
- Lift solution valve handle to start liquid flow to floor. Adjust amount of flow as needed.
- Close the solution valve completely 10 ft. (3m.) before you turn at the end of each cleaning path. This will reduce the amount of liquid on the floor when you make the turn.
- Open the solution valve when you have started your next cleaning path.
- Repeat this procedure on each path.
- Watch the level of liquid in the recovery tank and listen for the float shut-off to change the sound of the vacuum motor. The vacuum air flow will stop and you must empty the recovery tank.
- Take the machine to an approved disposal drain and turn off all switches.
- Raise the rubber flap at the front of the Wrangler and pull out the flexible rubber drain hose about 3 ft. (1m.).
- Raise the end of the hose above the level of the recovery tank, loosen and remove the hose drain plug.
- Carefully direct the drain hose into the drain.
- Replace and tighten the drain plug. Place the drain hose back into the machine and secure the plug end in the clamp. Do not obstruct the lift mechanism or brush motors.
- Resume cleaning operation. Refill solution tank and empty recovery tank as needed.
- When cleaning is complete, return machine to storage area and perform daily maintenance.

Special Cleaning

The Wrangler may be used to perform special cleaning jobs other than "normal" scrubbing.

- Double Scrubbing - This procedure provides deeper cleaning on heavily soiled floors. One or more cleaning passes are made before picking up the chemicals with the squeegee. Best results are achieved by placing the brush motors in the heavy scrub position. The floor surface becomes ex-

tremely slippery in this operation. The Wrangler should be operated only in low to medium speed and great care should be taken when walking on this surface.

- Stripping - This procedure is used to remove moderate build-up of floor finish from the floor. The most aggressive pads or grit brushes are used in this procedure. The stripper solution is applied to the floor with a mop and then double scrubbed as above. Clean water from the solution tank is applied to the floor to keep the chemicals and finish in a "liquid" condition. The floor

surface becomes extremely slippery in this operation. The Wrangler should be operated only in low to medium speed and great care should be taken when walking on this surface.

WORK COMPLETION

WARNING - You must turn OFF the Master power switch and all other switches when you have completed your work or leave the machine unattended for any amount of time.

Maintaining The Wrangler 27FB - 33FB Variable Speed Automatic Floor Scrubber

MACHINE MAINTENANCE

Routine maintenance is critical to ensure proper machine operation and cleaning performance. Perform all maintenance procedures as follows. **Always turn OFF all machine switches before performing any maintenance.**

DAILY MAINTENANCE

Battery Charging

- **The master power switch and all other switches must be turned OFF.**
- You must recharge the batteries at the end of every work shift or when the battery meter indicates the "recharge" during the work shift.
- Connect the battery charger plug (grey) to the machine charging plug.
- Connect the battery charger power cord into a grounded A. C. outlet of the proper voltage.
- After a few seconds the amp meter (or light) will indicate the battery charger is operating.
- When the recharge cycle is complete, the battery charger will turn off automatically. The amp meter will register "0" or the light will be off.
- If the battery charger will not start operating, check the charging plug connections, the battery cable connections and the battery voltage.
- If the batteries have been discharged (used) to deeply, the battery charger will not start.

Consult your local authorized NSS distributor or service center for assistance.

Battery Electrolyte (Liquid) Level

Inspect the electrolyte level of one cell in each battery before charging. The liquid must be visible above the internal plates. Do not charge the batteries if the liquid is below the plates.

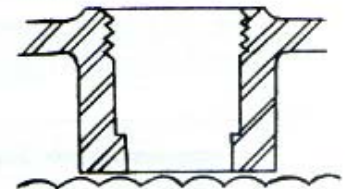

- Add only distilled water to the cell of a battery to adjust the liquid level. Before charging add only enough water to cover the top of the internal plates. After charging add only enough water to bring the level to the bottom of the fill tube.
- Do Not overfill the battery liquid level, this will cause electrolyte (acid) spill. Spilled electrolyte (acid) can cause machine damage and personal injury. Clean up and dispose of all spills immediately.

Solution and Recovery Tanks

- Empty all liquids from both solution and recovery tanks.
- Rinse both tanks with clean water to prevent chemical residue build-up. Empty both tanks.
- Remove float shut-off assembly from recovery tank. Clean any residue from screen and float ball to ensure proper operation. Replace float assembly on tube in recovery tank.
- Leave recovery tank clear lid open to allow tank to air dry and prevent odors.



Pad Drivers or Brushes

- Remove both pad drivers or brushes from machine.
- Rinse with clean water to prevent chemical residue build-up.
- Inspect for wear or damage. Repair or replace as needed.
- Allow to air dry on a shelf or rack.



Squeegee Assembly

- Remove squeegee assembly from machine.
- Rinse with clean water to prevent chemical residue build-up.
- Inspect for wear or damage. Repair or replace as needed.
- Allow to air dry on a shelf or rack.



WEEKLY MAINTENANCE

- Verify all daily maintenance has been performed.
- Inspect battery liquid level, adjust to proper level as needed.
- Check all battery terminal and cable connections. Tighten as needed.
- Clean any corrosion from battery terminals and cables.
- Check solution flow to pad drivers / brushes. Remove, inspect and clean the solution filter assembly.
- Flush clean solution tank and hoses with a mixture of 8 oz. (250ml.) white vinegar to one gallon (4 liter) warm water.
- Repair or replace any worn or damaged components as needed.

MONTHLY MAINTENANCE

- Verify all daily and weekly maintenance has been performed.
- Inspect vacuum motor filter under metal plate on top of recovery tank.

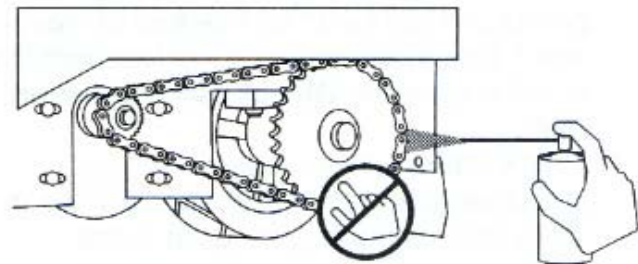

- Lubricate the drive chain and sprockets with a foaming spray type lubricant. A motorcycle spray type chain lube would be appropriate. Do not use your fingers to apply lubricant.
- Check chain tension, adjust as needed. Check chain tension by squeezing the chain midway between the sprockets. The chain should flex 1/4" (6mm) at each side.

- Adjust chain tension by loosening the four (4) hex bolts of the drive motor mount. Slide the drive motor toward the drive wheel to

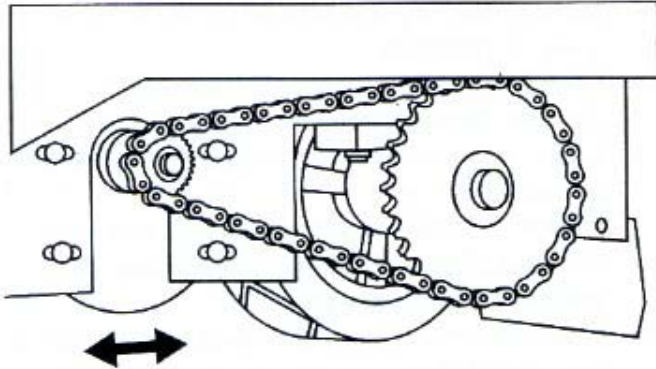

loosen chain. Slide drive motor away from drive wheel to tighten chain. Tighten all four hex bolts.

- Grease both pillow block bearings on the drive wheel axle and the caster axle and swivel bearing. Use a hand held grease gun and a high grade of water resistant lithium base grease.

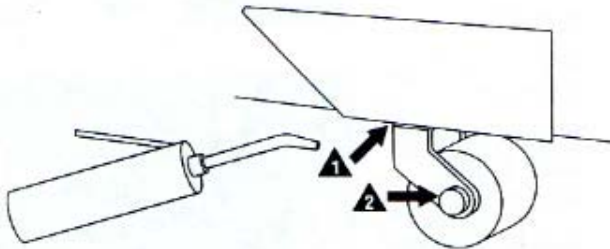

- Inspect all mechanical linkages, pivot points and ball joints for freedom of movement. Use a penetrating spray lubricant that is water resistant. **Do not use WD40 lubricant.**
- Check return springs of the twist grip (deadman) handles. If they appear weak or worn do not return twist grips to the neutral position, replace both springs.
- Inspect all fasteners (bolts, screws, nuts) at mechanical linkages, pivot points and ball joints for tightness. Tighten as needed.
- Repair or replace any worn or damaged components as needed.

MANDATORY PERIODIC MAINTENANCE

It is important for you to maintain a record of the amount of machine operating hours in order to perform this machine maintenance.

It is mandatory that the following maintenance procedure be performed at the described interval.

This procedure should be performed by an NSS authorized distributor or service center.

Failure to perform this procedure may result in poor machine performance, machine component damage and failure.

After every 650-700 hours of operation you must:

- Inspect drive motor carbon brushes for wear.
- Inspect brush drive motors carbon brushes for wear.

After every 250-300 hours of operation you must:

- Inspect vacuum motor carbon brushes for wear.
- Replace the drive motor carbon brushes when they are 3/8 in. (9mm) in length.
- Replace the brush drive motor carbon brushes when they are 1/2 in. (13mm) in length.
- Replace the vacuum motor carbon brushes when they are 7/16 in. (11mm) in length.

ACTIVATION OF DRY CHARGED BATTERIES

NSS supplies some batteries in a “dry charged” condition without any acid (electrolyte) in battery. The batteries cannot be used in this condition, they must be activated by the addition of the battery acid (electrolyte). Failure to follow this procedure will cause severe damage to the batteries.

MATERIALS REQUIRED

- 1.220 Specific Gravity Sulfuric acid to fill batteries
- Rubber gloves and safety eye protection for handling Sulfuric acid.
- Plastic funnel to pour Sulfuric acid into batteries.

- Adjustable wrench and pliers to install battery cables.

FILLING PROCEDURE

1. Remove the cap or plug from each cell of the battery.
2. Fill each cell with Sulfuric acid fully to the bottom of the access hole.
3. Allow the batteries to absorb the acid for a period of one hour. During this time the acid level in each cell will drop and the battery will become warm.
4. Refill each cell with Sulfuric acid to a point 1/4" (6 - 8mm) below the bottom of the access hole.
5. Replace the cap or plug in each cell of the battery.

6. Neutralize any spilled acid with bicarbonate of soda. Rinse the battery case clean with clean water and dry the battery case.
7. Install the batteries in the machine according to the wiring diagram and connect all battery cables. Tighten all connections.
8. Connect the battery charger to the machine charging plug (grey).
9. Allow the battery charger to perform one complete charging cycle (6 - 10 hours)
10. Liquid level adjustments during the life of the batteries should be made with distilled water. If distilled water is unavailable, use clean drinking water.

If dry charged batteries have been filled with acid (electrolyte) and are placed into storage, the batteries must be recharged every 30 days to prevent damage.



Wrangler 27-33 FB Automatic Scrubber

Serial No. _____

Date Installed: _____

Maintenance Record

Show that weekly, monthly and yearly maintenance has been completed with your initials and date.

Start with month of installation:	Month 1	Month 2	Month 3	Month 4	Month 5	Month 6
	Week 1					
<p>*Safety check items</p> <p>DAILY</p> <p>*Check for missing and broken parts.</p> <p>*Test operation of all switches.</p> <p>Inspect vacuum and recovery tank gaskets.</p> <p>Inspect float shut-off assembly.</p> <p>Check squeegee vacuum hose for obstructions.</p> <p>Clean squeegee assembly and inspect for damage</p> <p>Empty and rinse clean recovery tank.</p> <p>Inspect pad drivers and brushes for wear and damage.</p> <p>Charge batteries at end of shift.</p> <p>WEEKLY</p> <p>Check and adjust battery liquid level.</p> <p>Clean corrosion and liquids from batteries.</p> <p>*check battery terminal cable connections.</p> <p>Check solution flow to each brush.</p> <p>Flush solution tank and lines. Use 8 oz. vinegar to 1 gal. hot (130°F) water.</p> <p>MONTHLY</p> <p>Check and adjust drive chain tension. (if equipped)</p> <p>Lubricate these parts: drive chain, swival caster(s), brush and squeegee lift pivot arms, drive axle pillow blocks, squeegee pivot assembly.</p> <p>Check twist grip return springs.</p>	Week 2					
	Week 3					
	Week 4					
	Monthly					
	Month 7	Month 8	Month 9	Month 10	Month 11	Month 12
	Week 1					
	Week 2					
	Week 3					
	Week 4					
	Monthly					



Wrangler 27-33 FB Automatic Scrubber

Serial No. _____

Date Installed: _____

Maintenance Record

Show that weekly, monthly and yearly maintenance has been completed with your initials and date.

Start with month of installation:	Month 13	Month 14	Month 15	Month 16	Month 17	Month 18
		Week 1				
<p>*Safety check items</p> <p>DAILY</p> <p>*Check for missing and broken parts.</p> <p>*Test operation of all switches.</p> <p>Inspect vacuum and recovery tank gaskets.</p> <p>Inspect float shut-off assembly.</p> <p>Check squeegee vacuum hose for obstructions.</p> <p>Clean squeegee assembly and inspect for damage</p> <p>Empty and rinse clean recovery tank.</p> <p>Inspect pad drivers and brushes for wear and damage.</p> <p>Charge batteries at end of shift.</p> <p>WEEKLY</p> <p>Check and adjust battery liquid level.</p> <p>Clean corrosion and liquids from batteries.</p> <p>*check battery terminal cable connections.</p> <p>Check solution flow to each brush.</p> <p>Flush solution tank and lines. Use 8 oz. vinegar to 1 gal. hot (130°F) water.</p> <p>MONTHLY</p> <p>Check and adjust drive chain tension. (if equipped)</p> <p>Lubricate these parts: drive chain, swivel caster(s), brush and squeegee lift pivot arms, drive axle pillow blocks, squeegee pivot assembly.</p> <p>Check twist grip return springs.</p> <p>MONTH 18</p> <p>Replace carbon brushes in all motors.</p> <p>_____</p> <p>Initial here.</p>	Week 2					
	Week 3					
	Week 4					
	Monthly					
	Month 19	Month 20	Month 21	Month 22	Month 23	Month 24
	Week 1					
	Week 2					
	Week 3					
	Week 4					
	Monthly					



Wrangler 27-33 FB Automatic Scrubber

Serial No. _____

Date Installed: _____

Maintenance Record

Show that weekly, monthly and yearly maintenance has been completed with your initials and date.

Start with month of installation:	Month 25	Month 26	Month 27	Month 28	Month 29	Month 30
	Week 1					
<p>*Safety check items</p> <p>DAILY</p> <p>*Check for missing and broken parts.</p> <p>*Test operation of all switches.</p> <p>Inspect vacuum and recovery tank gaskets.</p> <p>Inspect float shut-off assembly.</p> <p>Check squeegee vacuum hose for obstructions.</p> <p>Clean squeegee assembly and inspect for damage</p> <p>Empty and rinse clean recovery tank.</p> <p>Inspect pad drivers and brushes for wear and damage.</p> <p>Charge batteries at end of shift.</p> <p>WEEKLY</p> <p>Check and adjust battery liquid level.</p> <p>Clean corrosion and liquids from batteries.</p> <p>*check battery terminal cable connections.</p> <p>Check solution flow to each brush.</p> <p>Flush solution tank and lines. Use 8 oz. vinegar to 1 gal. hot (130°F) water.</p> <p>MONTHLY</p> <p>Check and adjust drive chain tension. (if equipped)</p> <p>Lubricate these parts: drive chain, swivel caster(s), brush and squeegee lift pivot arms, drive axle pillow blocks, squeegee pivot assembly.</p> <p>Check twist grip return springs.</p>	Week 2					
	Week 3					
	Week 4					
	Monthly					
	Month 31	Month 32	Month 33	Month 34	Month 35	Month 36
	Week 1					
	Week 2					
	Week 3					
	Week 4					
	Monthly					
	<p>MONTH 36</p> <p>Replace carbon brushes in all motors.</p>					
	<p>_____</p> <p>Initial here.</p>					



Wrangler 27-33 FB Automatic Scrubber

Serial No. _____

Date Installed: _____

Maintenance Record

Show that weekly, monthly and yearly maintenance has been completed with your initials and date.

Start with month of installation:	Month 37	Month 38	Month 39	Month 40	Month 41	Month 42	
		Week 1					
<p>*Safety check items</p> <p>DAILY</p> <p>*Check for missing and broken parts.</p> <p>*Test operation of all switches.</p> <p>Inspect vacuum and recovery tank gaskets.</p> <p>Inspect float shut-off assembly.</p> <p>Check squeegee vacuum hose for obstructions.</p> <p>Clean squeegee assembly and inspect for damage</p> <p>Empty and rinse clean recovery tank.</p> <p>Inspect pad drivers and brushes for wear and damage.</p> <p>Charge batteries at end of shift.</p> <p>WEEKLY</p> <p>Check and adjust battery liquid level.</p> <p>Clean corrosion and liquids from batteries.</p> <p>*check battery terminal cable connections.</p> <p>Check solution flow to each brush.</p> <p>Flush solution tank and lines. Use 8 oz. vinegar to 1 gal. hot (130°F) water.</p> <p>MONTHLY</p> <p>Check and adjust drive chain tension. (if equipped)</p> <p>Lubricate these parts: drive chain, swival caster(s), brush and squeegee lift pivot arms, drive axle pillow blocks, squeegee pivot assembly.</p> <p>Check twist grip return springs.</p>							
		Week 2					
		Week 3					
		Week 4					
		Monthly					
		Month 43	Month 44	Month 45	Month 46	Month 47	Month 48
		Week 1					
		Week 2					
		Week 3					
		Week 4					
		Monthly					

TROUBLESHOOTING WRANGLER AUTOMATIC SCRUBBERS
(Your Model May Not Include All Items Mentioned)

Problem	Cause	Solution
No Solution Flow	The solution valve is closed. Obstruction in the solution hose. Solution valve or linkage damaged. Solution tank is empty.	Open the solution valve. Remove the obstruction. Repair or replace the valve or linkage. Fill the tank.
Solution Flow Does Not Stop	The solution valve is open. Solution valve or linkage damaged. Solution valve is dirty. Damaged seat & washer in valve.	Close the solution valve. Repair/replace the valve/linkage. Clean the solution valve. Replace valve.
Will Not Pick Up Any Water From the Floor	Squeegee is up. Vac motor switch is "off" Recovery tank is full. Vacuum shut-off float is stuck. Foam filter is dirty. Obstruction/damage in the squeegee, squeegee hose or standpipe. Leaking clear lid on recovery tank. Vac motor is not running.	Lower squeegee. Turn vac motor switch "on." Empty tank. Clean or replace float assembly. Clean or replace filter (under metal plate). Remove obstruction/repair damage. Tighten or replace clear lid. Have an authorized serviceman repair.
Batteries Do Not Seem To Run Long Enough	Tops of batteries are dirty/wet. Battery terminals are dirty/damaged. Electrolyte level is too low. Batteries are not fully charged. Charger is damaged. Battery is defective.	Clean and dry, then charge batteries. Clean terminals & connectors, replace damaged cables. Charge batteries. Add distilled water & charge batteries. Charge batteries with automatic charger. Have an authorized serviceman repair. Check cell voltage while discharging.
Cleaning Is Not Even	Brushes/pads are worn. Damage to brush assembly, casters, or solution valve. Motors are not running.	Replace Have authorized serviceman repair. Repair wiring, replace switch, replace carbon brushes. Reset or replace circuit breaker, check or replace fuse.
Machine Does Not Run	The machine loses power.	Reset all circuit breakers. Charge batteries and test run machine. Have service station test batteries.

Note: If problems remain after taking the above steps, contact your local authorized NSS distributor or service station for further assistance.

27FB - 33FB Wrangler Automatic Scrubber Accessories

Batteries - 36 Volt System

<u>Part Number</u>	<u>Description</u>
3390361	6 Volt, 220 Amp Hour (AH) Battery, Wet, 6 Required
3390951	6 Volt, 220 Amp Hour (AH) Battery, Dry, 6 Required
3390371	6 Volt, 270 Amp Hour (AH) Battery, Wet, 6 Required
3390941	6 Volt, 270 Amp Hour (AH) Battery, Dry, 6 Required
2691501	6 Volt, 305 Amp Hour (AH) Battery, Wet, 6 Required
2690951	6 Volt, 305 Amp Hour (AH) Battery, Dry, 6 Required

Battery Chargers

<u>Part Number</u>	<u>Description</u>
2698041	36 Volt, 25 Amp Output, 120 Volt A/C, Use with 305 AH Batteries
2698031	36 Volt, 25 Amp Output, 240 Volt A/C, Use with 305 AH Batteries
4491771	36 Volt, 25 Amp Output, 120 Volt A/C, Use with 220AH / 270AH Batteries
4491781	36 Volt, 25 Amp Output, 240 Volt A/C, Use with 220AH / 270AH Batteries
4491791	36 Volt, 25 Amp Output, 100 Volt A/C, Use with 220AH / 270AH Batteries

Optional Equipment

<u>Part Number</u>	<u>Description</u>
2693609	Curved Squeegee Assembly, Heavy Duty, Gum Rubber Blades, 43in. (109cm) Long
2690519	Key Switch, With Boot, Universal 24 Volt / 36 Volt, Field Retrofit
2795739	Hour Meter, Universal 24 Volt / 36 Volt, Field Retrofit

WRANGLER 33FB ONLY

Pad Driver / Brushers - 2 Required

<u>Part Number</u>	<u>Description</u>
3390891	17 in. (43cm) Poly Block, Tufted Pad Driver, (includes pad holder part number 2795241)
3390501	17 in. (43 cm) Poly Back Bassine Scrub Brush
3390511	17 in. (43 cm) Poly Back Nylon Scrub Brush
3390521	17 in. (43 cm) Poly Back Nylo Grit Scrub Brush
3390531	17 in. (43 cm) Poly Back Wire Scrub Brush
2795241	Pad Holder Assembly, Includes Base (Female) and Pad Holder (Male)
2795231	Split Retaining Snap Ring Only, (Pad Holder Male), For Part Number 3390891

WRANGLER 27 FB ONLY

Pad Driver / Brushes - 2 Required

<u>Part Number</u>	<u>Description</u>
2792891	14 in. (36cm) Poly Block, Tufted Pad Driver, (includes pad holder part number 2795241)
2792501	14 in. (36cm) Poly Back Bassine Scrub Brush
2792511	14 in. (36cm) Poly Back Nylon Scrub Brush
2792521	14 in. (36cm) Poly Back Nylo Grit Scrub Brush
2792531	14 in. (36cm) Poly Back Wire Scrub Brush
2795241	Pad Holder Assembly, Includes Base (Female) and Pad Holder (Male)
2795231	Split Retaining Snap Ring Only, (Pad Holder Male), For Part Number 2792891



NSS® Enterprises, Inc.

3115 Frenchmens Road, Toledo, Ohio 43607

PHONE (419) 531-2121 FAX (419) 531-3761

NSS® Enterprises, Inc. European Distribution Centre

Unit II, Pinfold Trading Estate * 55 Nottingham Road

STAPLEFORD, NOTTINGHAM NG9 8AD ENGLAND U.K.

PHONE: (44) 0115 939 1568 * FAX: (44) 0115 949 0615