

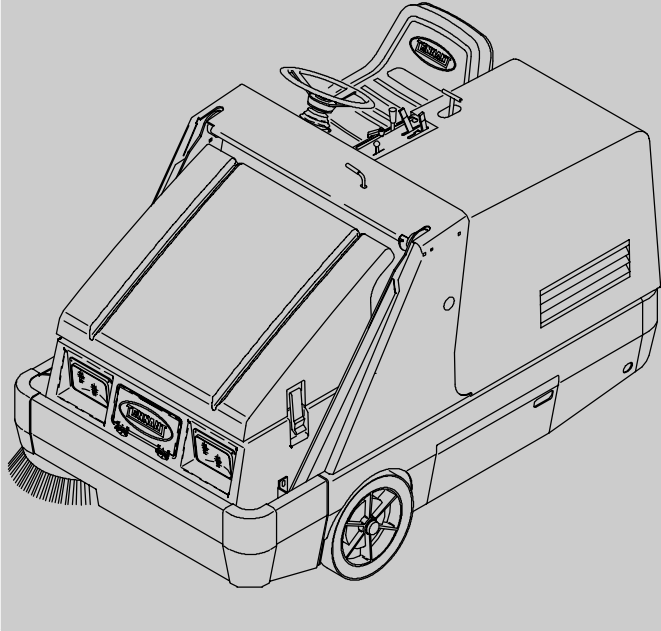

# 6400

(Diesel)

## Sweeper Operator Manual



**North America / International**

[www.tennantco.com](http://www.tennantco.com)

**MM431**  
**Rev. 12 (04-2009)**





This manual is furnished with each new model. It provides necessary operation and maintenance instructions.

**Read this manual completely and understand the machine before operating or servicing it.**

This machine will provide excellent service. However, the best results will be obtained at minimum costs if:

- The machine is operated with reasonable care.
- The machine is maintained regularly - per the machine maintenance instructions provided.
- The machine is maintained with manufacturer supplied or equivalent parts.

	<b>PROTECT THE ENVIRONMENT</b> Please dispose of packaging materials, old machine components such as batteries, hazardous fluids including antifreeze and oil, in an environmentally safe way according to local waste disposal regulations.
	Always remember to recycle.

<b>MACHINE DATA</b>	
Please fill out at time of installation for future reference.	
Model No. -	_____
Serial No. -	_____
Machine Options -	_____
Sales Rep. -	_____
Sales Rep. phone no. -	_____
Customer Number -	_____
Installation Date -	_____

**Tennant Company**

PO Box 1452

Minneapolis, MN 55440

Phone: (800) 553-8033 or (763) 513-2850

[www.tennantco.com](http://www.tennantco.com)



**CALIFORNIA PROPOSITION 65 WARNING:**

**Engine exhaust from this product contains chemicals known to the State of California to cause cancer, birth defects, or other reproductive harm.**

Thermo-Sentry, Instant Access, and Perma-Filter are US registered and unregistered trademarks of Tennant Company.

Specifications and parts are subject to change without notice.

Original instructions, Copyright © 1996-2000, 2001, 2002, 2004, 2006-2009 TENNANT Company, Printed in U.S.A.

**CONTENTS**

	Page		Page
CONTENTS .....	1	SWEEPING AND BRUSH INFORMATION .	27
SAFETY PRECAUTIONS .....	3	SWEEPING .....	28
OPERATION .....	6	STOP SWEEPING .....	30
OPERATOR RESPONSIBILITY .....	6	EMPTYING THE HOPPER .....	31
MACHINE COMPONENTS .....	7	STOP THE MACHINE .....	33
SYMBOL DEFINITIONS .....	8	POST-OPERATION CHECKLIST .....	35
CONTROLS AND INSTRUMENTS .....	10	ENGAGING HOPPER SUPPORT BAR ...	36
OPERATION OF CONTROLS .....	11	DISENGAGING HOPPER	
DIRECTIONAL PEDAL .....	11	SUPPORT BAR .....	38
BRAKE PEDAL .....	12	OPERATION ON INCLINES .....	39
PARKING BRAKE PEDAL .....	12	OPTIONS .....	40
SEAT SUPPORT RELEASE LEVER ...	12	VACUUM WAND .....	40
THROTTLE LEVER .....	13	MACHINE TROUBLESHOOTING .....	42
HOPPER LEVER .....	13	MAINTENANCE .....	44
HOPPER DOOR LEVER .....	13	MAINTENANCE CHART .....	44
MAIN BRUSH LEVER .....	14	LUBRICATION .....	46
MAIN BRUSH DOWN		ENGINE .....	46
PRESSURE KNOB .....	14	REAR WHEEL SUPPORT .....	46
VACUUM AND FILTER		STEERING CYLINDER .....	46
SHAKER LEVER .....	14	FRONT WHEEL BEARINGS .....	47
CHARGING SYSTEM LIGHT .....	15	HOPPER LIFT ARM PIVOTS .....	47
ENGINE OIL PRESSURE LIGHT .....	15	HYDRAULICS .....	48
ENGINE TEMPERATURE LIGHT .....	15	HYDRAULIC FLUID RESERVOIR ....	48
HOPPER TEMPERATURE LIGHT -		HYDRAULIC FLUID .....	48
THERMO SENTRY .....	16	HYDRAULIC HOSES .....	49
GLOW PLUG LIGHT .....	16	PROPELLING MOTOR .....	49
CLOGGED FILTER LIGHT (OPTION) ..	17	ENGINE .....	50
HOPPER DOOR CLOSED		COOLING SYSTEM .....	50
LIGHT (OPTION) .....	17	AIR FILTER INDICATOR (OPTION) ...	50
HYDRAULIC FILTER BYPASS		AIR FILTER .....	51
LIGHT (OPTION) .....	18	FUEL FILTERS .....	52
FUEL LEVEL GAUGE .....	18	FUEL LINES .....	52
STEERING WHEEL .....	18	PRIMING THE FUEL SYSTEM .....	53
HOURMETER .....	18	VALVE CLEARANCE .....	53
STEERING WHEEL TILT HANDLE ...	19	ELECTRICAL .....	54
IGNITION SWITCH .....	19	BATTERY .....	54
HORN BUTTON .....	19	BELTS AND CHAINS .....	55
SIDE BRUSH LEVER .....	20	ENGINE BELT .....	55
OPERATING LIGHTS SWITCH .....	20	VACUUM FAN BELT .....	55
OPERATING/HAZARD LIGHTS		STATIC DRAG CHAIN .....	55
SWITCH (OPTION) .....	20	DEBRIS HOPPER .....	56
SIDE BRUSH DOWN		HOPPER DUST FILTER .....	56
PRESSURE KNOB .....	21	REMOVING HOPPER DUST FILTER ..	56
FUSES .....	21	BRUSHES .....	58
CIRCUIT BREAKERS .....	21	MAIN BRUSH .....	58
OPERATOR SEAT .....	22	REPLACING MAIN BRUSH .....	58
DELUXE SUSPENSION		CHECKING AND ADJUSTING	
SEAT (OPTION) .....	22	MAIN BRUSH PATTERN .....	59
HOPPER SUPPORT BAR .....	23	SIDE BRUSH .....	61
HOW THE MACHINE WORKS .....	24	REPLACING SIDE BRUSH .....	61
PRE-OPERATION CHECKLIST .....	24	SIDE BRUSH GUARD .....	62
STARTING THE MACHINE .....	25	SIDE BRUSH PIVOT .....	62

# CONTENTS

---

	Page
SKIRTS AND SEALS .....	63
HOPPER LIP SKIRT .....	63
HOPPER SIDE SKIRT .....	63
BRUSH DOOR SKIRTS .....	63
REAR SKIRTS .....	64
SIDE BRUSH DUST CONTROL	
SKIRTS (OPTION) .....	64
BRUSH DOOR SEALS .....	64
HOPPER SEALS .....	64
HOPPER ACCESS DOOR SEAL .....	65
HOPPER DOOR SEALS .....	65
VACUUM FAN SEAL .....	65
BRAKES AND TIRES .....	66
BRAKES .....	66
TIRES .....	66
REAR WHEEL .....	66
PUSHING, TOWING, AND	
TRANSPORTING THE MACHINE .....	67
PUSHING OR TOWING THE MACHINE .....	67
TRANSPORTING THE MACHINE .....	68
MACHINE JACKING .....	70
STORING MACHINE .....	70
SPECIFICATIONS .....	71
GENERAL MACHINE PERFORMANCE .....	71
POWER TYPE .....	72
STEERING .....	72
HYDRAULIC SYSTEM .....	72
MACHINE DIMENSIONS .....	73
INDEX .....	74

## SAFETY PRECAUTIONS

The following precautions are used throughout this manual as indicated in their description:



**WARNING: To warn of hazards or unsafe practices that could result in severe personal injury or death.**

**FOR SAFETY: To identify actions that must be followed for safe operation of equipment.**

The machine is suited to sweep disposable debris. Do not use the machine other than described in this Operator Manual. The machine is not designed for use on public roads.

The following information signals potentially dangerous conditions to the operator or equipment:



**WARNING: Engine emits toxic gases. Severe respiratory damage or asphyxiation can result. Provide adequate ventilation. Consult with your regulatory authorities for exposure limits. Keep engine properly tuned.**



**WARNING: Lift arm pinch point. Stay clear of hopper lift arms.**



**WARNING: Raised hopper may fall. Engage hopper support bar.**



**WARNING: Moving belt and fan. Keep away.**

**FOR SAFETY:**

1. **Do not operate machine:**
  - Unless trained and authorized.
  - Unless operation manual is read and understood.
  - In flammable or explosive areas unless designed for use in those areas.
  - In areas with possible falling objects unless equipped with overhead guard.
2. **Before starting machine:**
  - Check for fuel leaks.
  - Keep sparks and open flame away from refueling area.
  - Make sure all safety devices are in place and operate properly.
  - Check brakes and steering for proper operation.
3. **When starting machine:**
  - Keep foot on brake and directional pedal in neutral.
4. **When using machine:**
  - Do not pick up burning or smoking debris, such as cigarettes, matches or hot ashes.
  - Use brakes to stop machine.
  - Go slowly on inclines and slippery surfaces.
  - Use care when reversing machine.
  - Move machine with care if hopper is raised.
  - Make sure adequate clearance is available before raising hopper.
  - Do not carry passengers on machine.
  - Always follow safety and traffic rules.
  - Report machine damage or faulty operation immediately.
5. **Before leaving or servicing machine:**
  - Stop on level surface.
  - Set parking brake.
  - Turn off machine and remove key.
6. **When servicing machine:**
  - Avoid moving parts. Do not wear loose jackets, shirts, or sleeves.
  - Block machine tires before jacking up machine.
  - Jack up machine at designated locations only. Block machine up with jack stands.
  - Use hoist or jack that will support the weight of the machine.
  - Wear eye and ear protection if using pressurized air or water.
  - Disconnect battery connections before working on machine.
  - Avoid contact with battery acid.
  - Avoid contact with hot engine coolant.
  - Allow engine to cool.
  - Keep flames and sparks away from fuel system service area. Keep area well ventilated.
  - Use cardboard to locate leaking hydraulic fluid under pressure.
  - Use Tennant supplied or approved replacement parts.

## **SAFETY PRECAUTIONS**

---

- 7. When loading/unloading machine onto/off truck or trailer:**
  - **Turn off machine.**
  - **Use truck or trailer that will support the weight of the machine.**
  - **Use winch. Do not drive the machine onto/off the truck or trailer unless the load height is 380 mm (15 in) or less from the ground.**
  - **Set parking brake after machine is loaded.**
  - **Block machine tires.**
  - **Tie machine down to truck or trailer.**

**SAFETY PRECAUTIONS**

The following safety labels are mounted on the machine in the locations indicated. If these or any labels become damaged or illegible, install a new label in its place.

**EMISSIONS LABEL - LOCATED ON THE SIDE OF THE OPERATOR COMPARTMENT.**



**FOR SAFETY LABEL - LOCATED ON THE SIDE OF THE OPERATOR COMPARTMENT.**

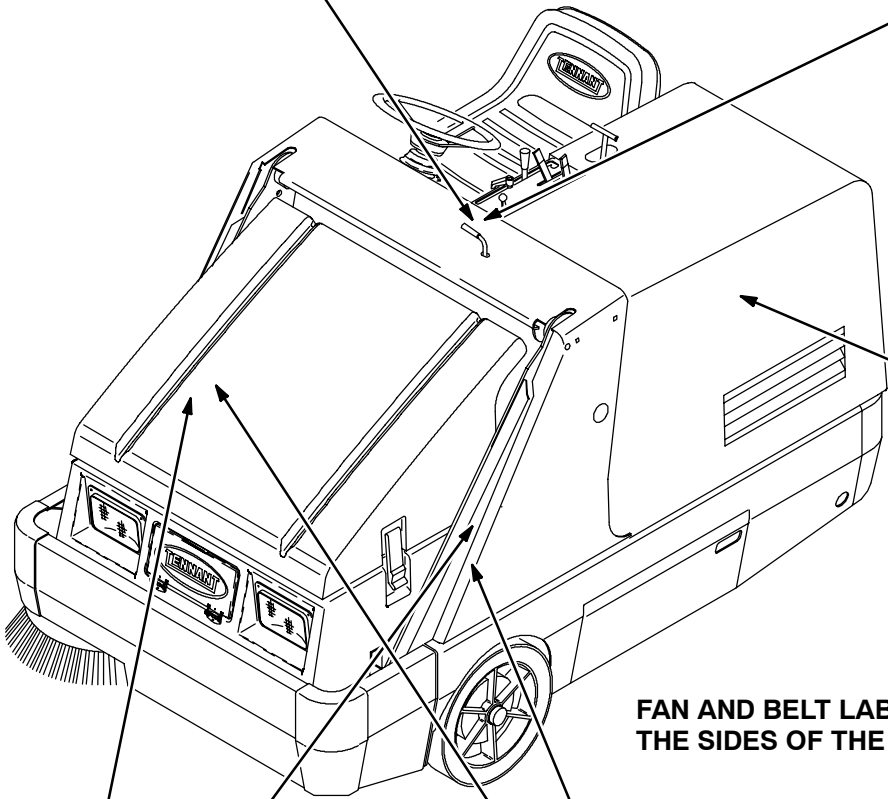

**FAN AND BELT LABEL - LOCATED ON THE SIDES OF THE RADIATOR SHROUD.**



**HOPPER SUPPORT LABEL - LOCATED ON BOTH LIFT ARMS AND THE HOPPER SUPPORT BAR.**



**HOPPER LIFT ARMS LABEL - LOCATED ON BOTH LIFT ARMS.**

350159

### OPERATOR RESPONSIBILITY

- The operator's responsibility is to take care of the daily maintenance and checkups of the machine, to keep it in good working condition. The operator must inform the service mechanic or supervisor when the required maintenance intervals occur as stated in the *MAINTENANCE* section of this manual.
- Read this manual carefully before operating the machine. View the operation video supplied with the machine.

**FOR SAFETY: Do not operate machine, unless operation manual is read and understood.**

- Check the machine for shipping damage. Check to make sure the machine is complete per shipping instructions.
- Keep your machine regularly maintained by following the maintenance information in this manual. We recommend taking advantage of a regularly scheduled service contract from your Tennant representative.
- Order parts and supplies directly from your authorized Tennant representative. Use the parts manual provided when ordering parts.
- After the first 50 hours of operation, follow the recommended procedures stated in the *MAINTENANCE CHART*.

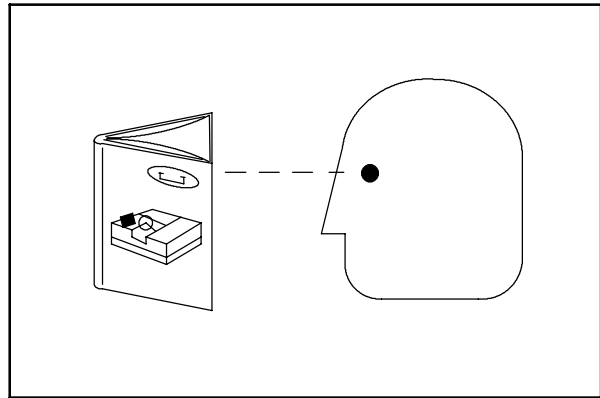

07324



---

**MACHINE COMPONENTS**

---

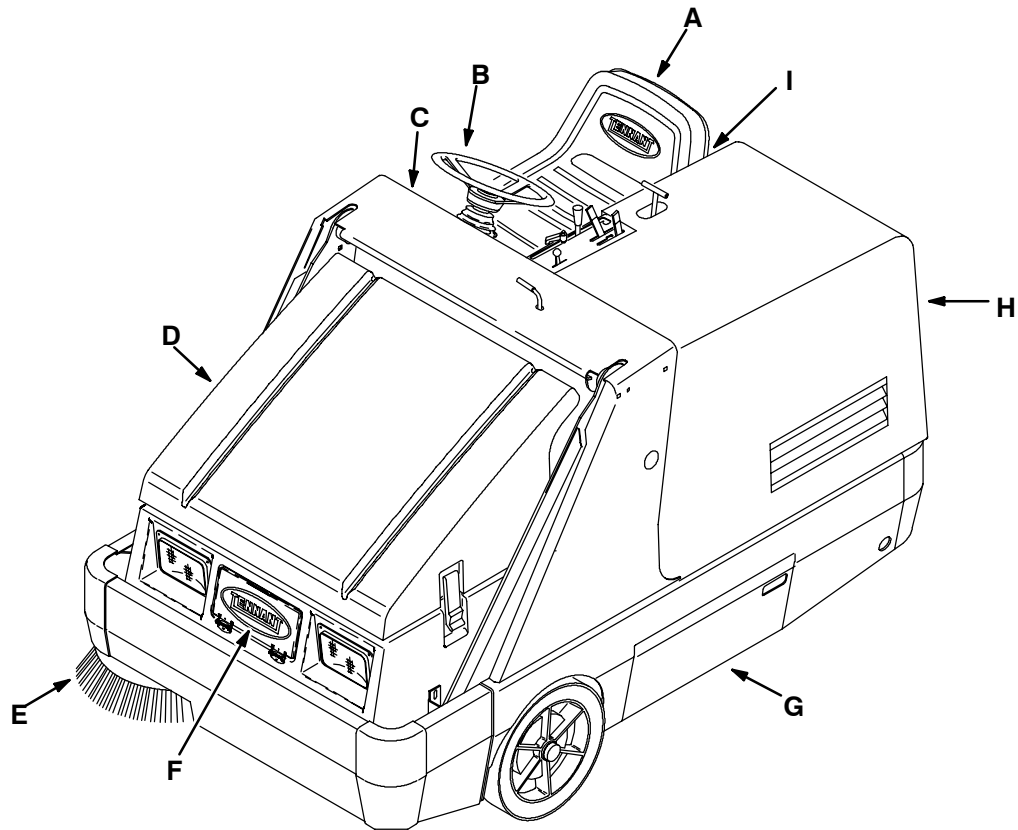

- A. Operator seat
- B. Steering wheel
- C. Instrument panel
- D. Hopper cover
- E. Side brush
- F. Hopper access door
- G. Brush door
- H. Seat support
- I. Fuel tank

350159

## SYMBOL DEFINITIONS

These symbols identify controls, displays, and features on the machine:



Filter shaker



Vacuum fan on



Vacuum fan off



Fast engine speed



Idle engine speed



Hopper down



Hopper up



Hopper door open



Hopper door close



Main brush down and on



Main brush up and off



Battery charging system



Engine oil pressure



Engine water temperature



Thermo Sentry



Glow plugs



Clogged dust filter



Hopper door closed



Hydraulic filter clogged



Hourmeter



Steering wheel tilt



Off



On



Start



Horn



Operating lights



Hazard light



Side brush down and on



Side brush up and off



Variable pressure



Side brush pressure



Circuit breaker #1



Circuit breaker #2



Circuit breaker #3



Circuit breaker #4



Circuit breaker #5



Diesel fuel only

## CONTROLS AND INSTRUMENTS

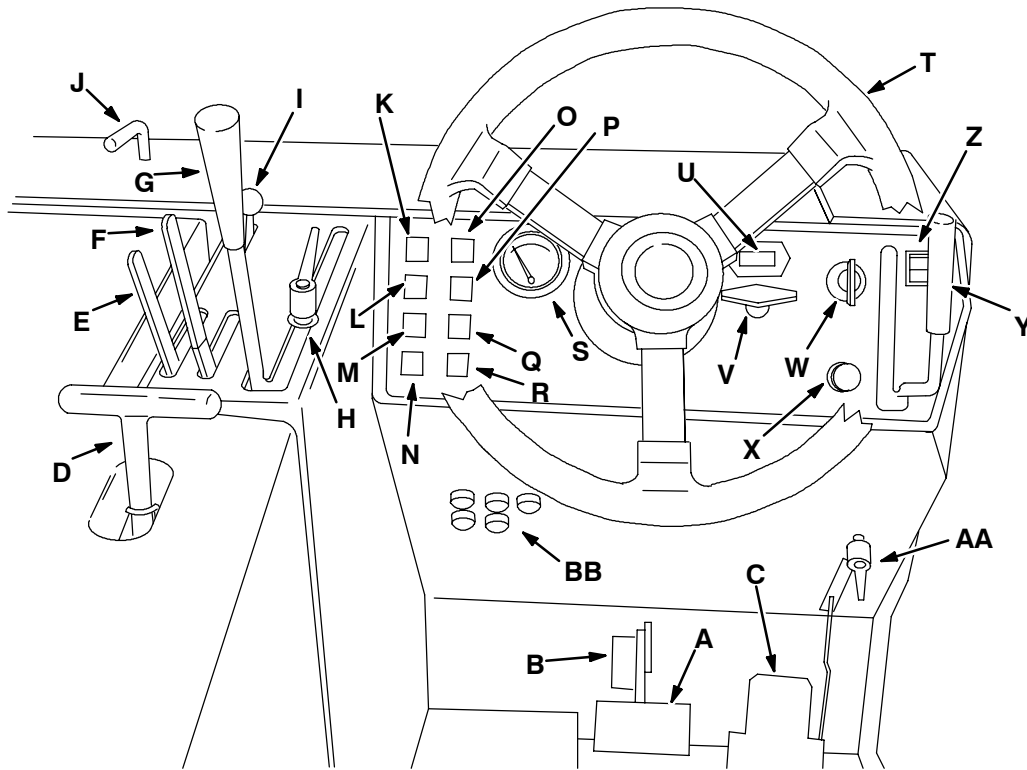

350013

- A. Brake pedal
- B. Parking brake pedal
- C. Directional pedal
- D. Seat support release lever
- E. Hopper lever
- F. Hopper door lever
- G. Main brush lever
- H. Main brush down pressure knob
- I. Throttle lever
- J. Vacuum and filter shaker lever
- K. Charging system light
- L. Engine oil pressure light
- M. Engine temperature light
- N. Hopper temperature light - Thermo Sentry
- O. Glow plug light
- P. Clogged filter light (option)
- Q. Hopper door closed light (option)
- R. Hydraulic filter bypass light (option)
- S. Fuel level gauge
- T. Steering wheel
- U. Hourmeter
- V. Steering wheel tilt handle
- W. Ignition switch
- X. Horn button
- Y. Side brush lever
- Z. Operating light switch (Operating/hazard light switch option)
- AA. Side brush down pressure knob
- BB. Circuit breakers

---

**OPERATION OF CONTROLS**

---

**DIRECTIONAL PEDAL**

The directional pedal controls the direction of travel and the propelling speed of the machine. You change the speed of the machine with the pressure of your foot on the pedal; the harder you press, the faster the machine travels.

Forward: Press the top of the directional pedal with the toe of your foot.

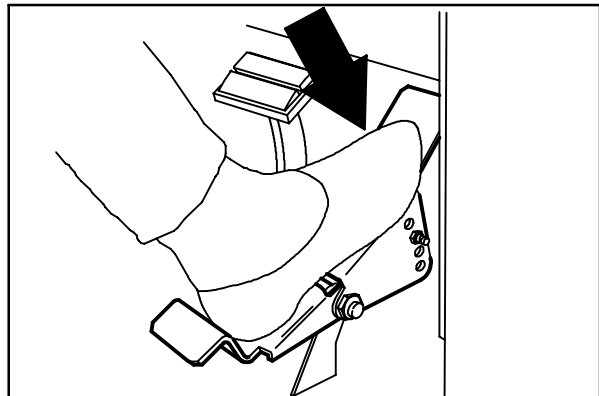

07790

Reverse: Press the bottom of the directional pedal with the heel of your foot.

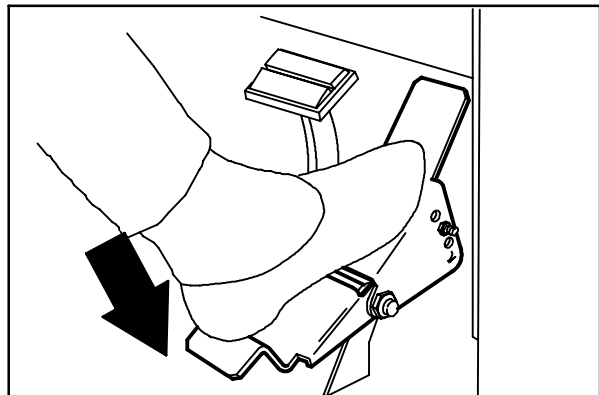

07791

Neutral: Take your foot off the directional pedal and it will return to the **Neutral** position.

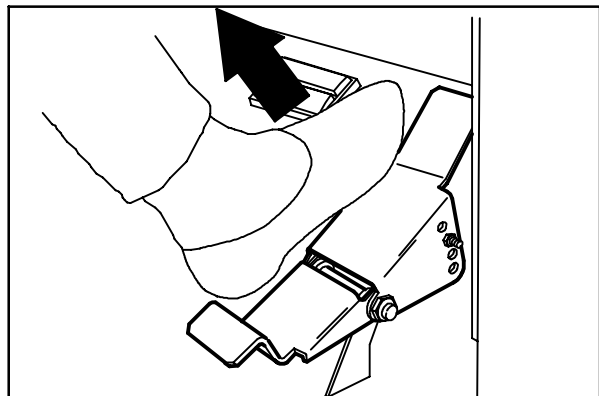

07792

## OPERATION

### BRAKE PEDAL

The brake pedal stops the machine.

Stop: Take your foot off the directional pedal and let it return to the **Neutral** position. Step on the brake pedal.

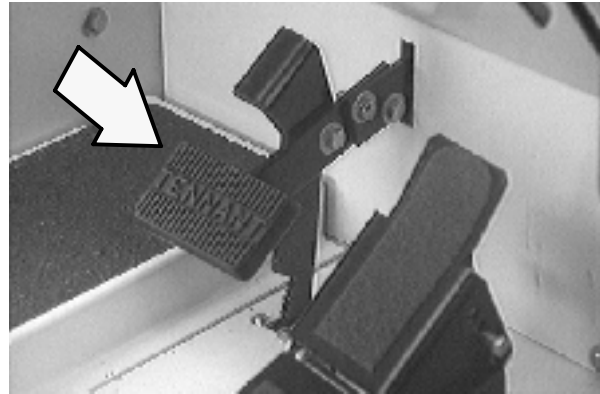

### PARKING BRAKE PEDAL

The parking brake pedal sets and releases the front wheel brakes.

Set: Press on the brake pedal as far as possible, then press on the parking brake pedal with the toe portion of your foot to lock the parking brake pedal in place.

**FOR SAFETY: Before leaving or servicing machine, stop on level surface, set parking brake, turn off machine, and remove key.**

Release: Press on the brake pedal to unlock the parking brake pedal.

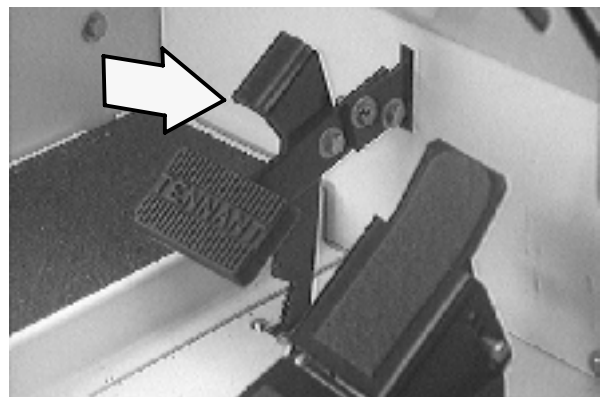

### SEAT SUPPORT RELEASE LEVER

The seat support lever releases and locks the seat support.

Release: Pull the lever back and lift the seat support.

Lock: Close the seat support and release the lever to lock the support in place.

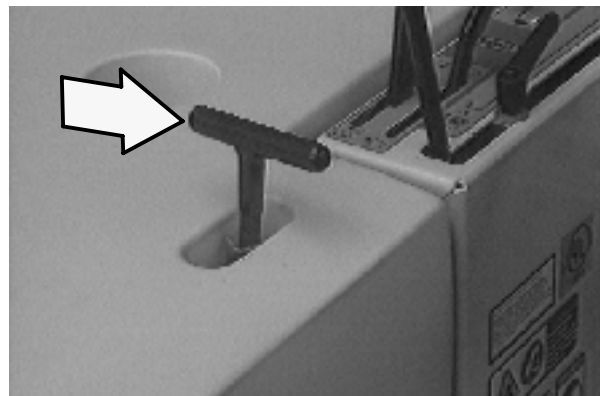

### THROTTLE LEVER

The throttle lever controls the engine speed.

Fast: Push the throttle lever all the way forward.

Idle: Pull the throttle lever all the way back.

*NOTE: Only operate the throttle all the way open in the **Fast engine speed** position when sweeping. Operating the throttle at any other position will reduce performance. Pull the throttle lever all the way back before turning the machine off.*

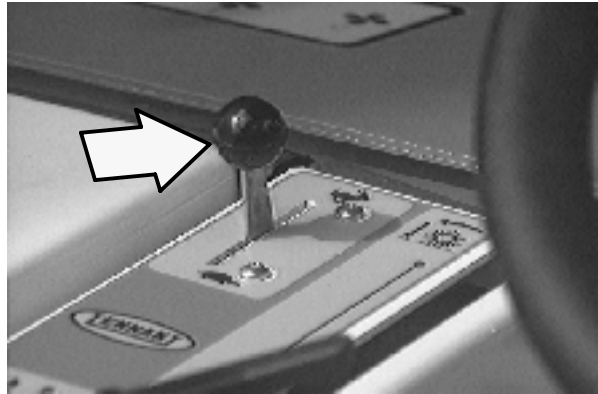

### HOPPER LEVER

The hopper lever raises and lowers the hopper.

Hopper up: Pull the hopper lever into the **Hopper up** position.

Hold: Release the hopper lever into the middle position.

Hopper down: Push the hopper lever into the **Hopper down** position.

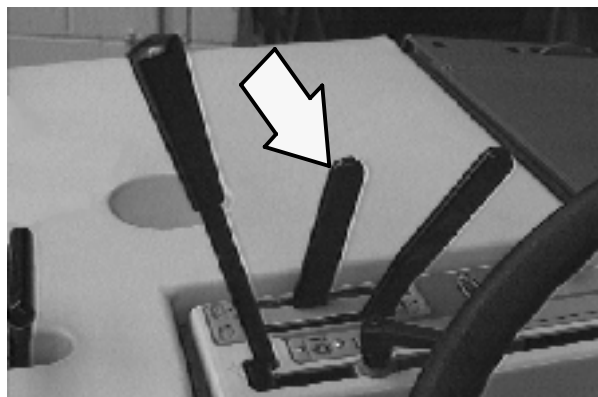

### HOPPER DOOR LEVER

The hopper door lever opens and closes the hopper door. Open the hopper door before sweeping. Close the hopper door before emptying the hopper to control debris and dust.

Hopper door open: Push the hopper door lever forward into the **Hopper door open** position.

Hopper door close: Pull the hopper door lever back into the **Hopper door close** position for a few seconds until the hopper door is closed.

*NOTE: If the machine is equipped with the hopper door closed light option, the light will come on when the hopper door is closed.*

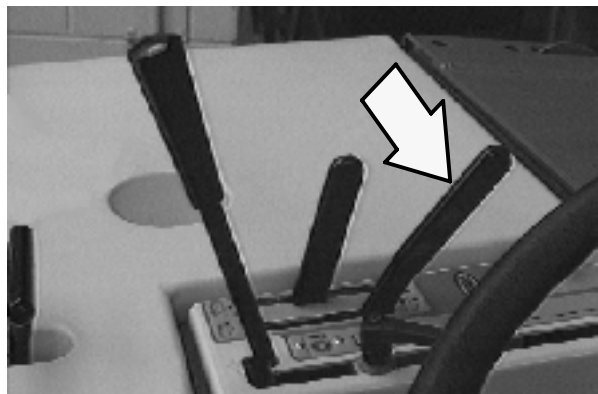

## OPERATION

### MAIN BRUSH LEVER

The main brush lever controls the position and rotation of the main brush.

**Main brush down and on:** Pull the lever back and to the right into the **Main brush down and on** position against the main brush down pressure knob. The brush will automatically start rotating.

**Main brush up and off:** Pull the lever back and to the left into the **Main brush up and off** position.

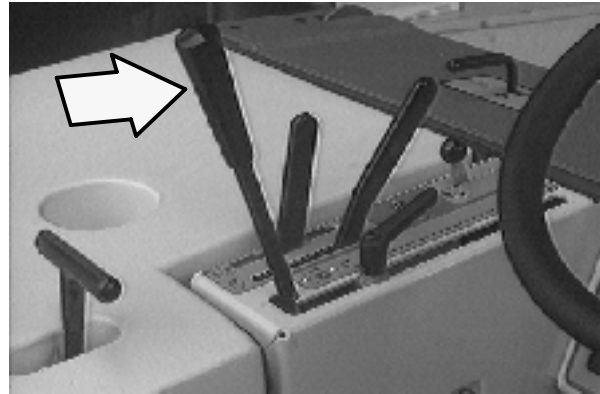

### MAIN BRUSH DOWN PRESSURE KNOB

The main brush down pressure knob changes the amount of contact the main brush has with the surface being swept.

**Increase:** Loosen the main brush down pressure knob. Move the knob forward, away from the operator, and retighten it.

**Decrease:** Loosen the main brush down pressure knob. Move the knob back, towards the operator, and retighten it.



### VACUUM AND FILTER SHAKER LEVER

The vacuum and filter shaker lever controls the vacuum fan duct and the filter shaker. The vacuum fan duct should be on when sweeping dry debris. The vacuum fan duct should be off when sweeping wet debris.

**Vacuum Fan on:** Turn the lever to the left into the **Vacuum Fan on** position.

**Vacuum Fan off:** Turn the lever to the right into the **Vacuum Fan off** position.

**Start filter shaker:** Place the lever in the **Filter shaker** position for 30 seconds.

*Note: Excessive heat in the hopper will cause the Thermo Sentry™ to move the vacuum and filter shaker lever to the **Vacuum fan off** position. It will also make the hopper temperature light come on. If this happens, stop the machine, eliminate the source of the heat, and return the lever to the **Vacuum fan on** position.*

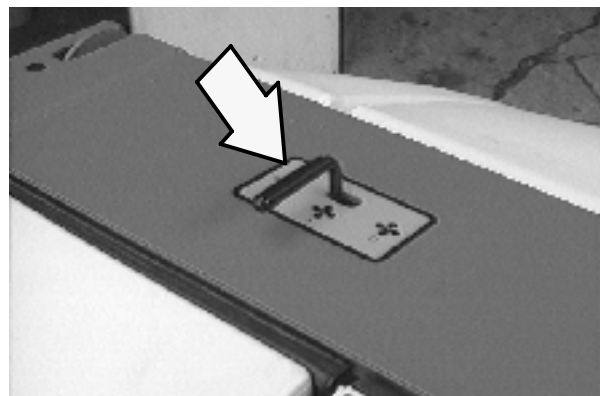



**CHARGING SYSTEM LIGHT**

The charging system light comes on when the alternator is not operating within normal range; 13.5 to 14.5 V. If the light comes on, stop operating the machine. Locate the problem and have it corrected.

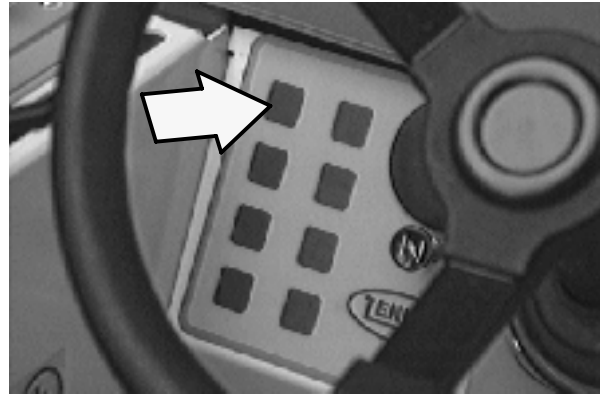
**ENGINE OIL PRESSURE LIGHT**

The engine oil pressure light comes on when the engine oil pressure falls below 40 kPa (5 psi). If the light comes on, stop operating the machine. Locate the problem and have it corrected.

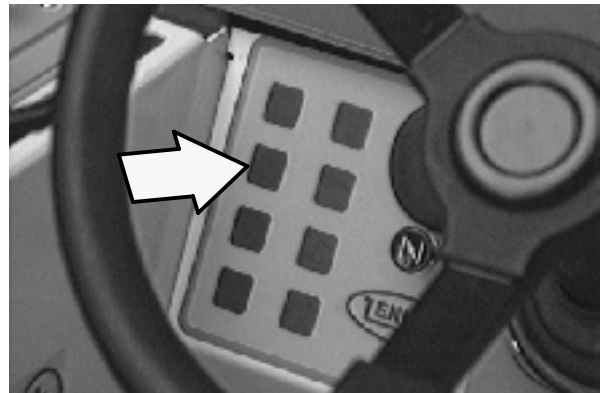
**ENGINE TEMPERATURE LIGHT**

The engine water temperature light comes on when the temperature of the engine coolant is more than 107° C (225° F). If the light comes on, stop operating the machine. Locate the problem and have it corrected.

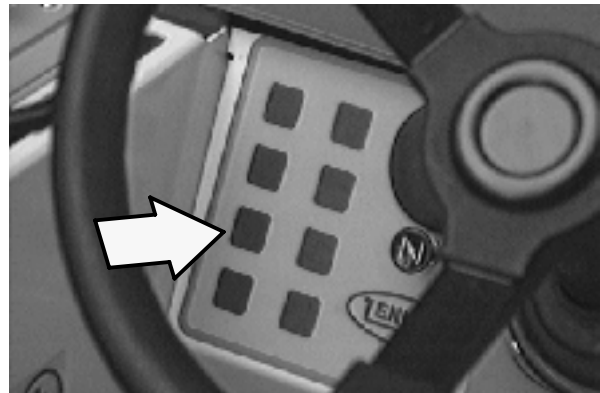

## OPERATION

### HOPPER TEMPERATURE LIGHT - THERMO SENTRY

The hopper temperature light comes on when the Thermo Sentry senses that there is excessive heat in the hopper, possibly from a fire. The Thermo Sentry will also move the vacuum and filter shaker lever to the **Vacuum fan off** position. If this happens, stop the machine, eliminate the source of the heat, and return the lever to the **Vacuum fan on** position.

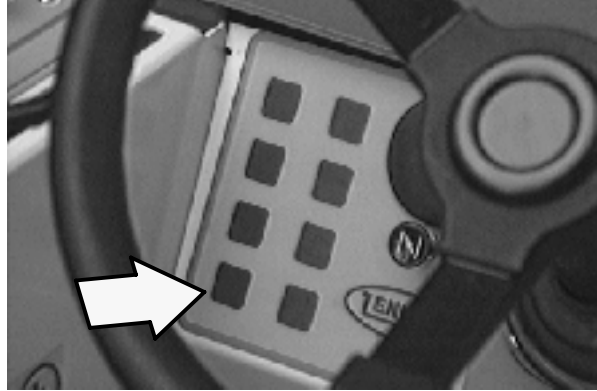

### GLOW PLUG LIGHT

The glow plug light comes on when the ignition switch is turned counterclockwise to the **Glow plugs** position. The light will go out when the engine is ready to start.

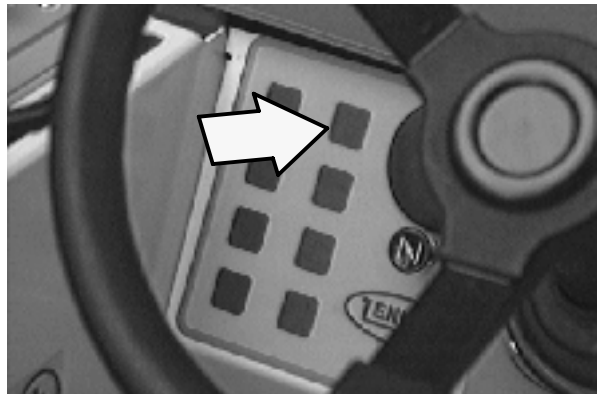

**CLOGGED FILTER LIGHT (OPTION)**

The clogged filter light comes on when the hopper dust filter is clogged.

To clean the filter, hold the vacuum and filter shaker lever in the **Filter shaker** position. If the clogged filter light remains lit, manually clean the hopper dust filter. See *HOPPER DUST FILTER* in the *MAINTENANCE* section of this manual.

*NOTE: The clogged filter light also comes on when the hopper door is closed and the vacuum fan is on.*

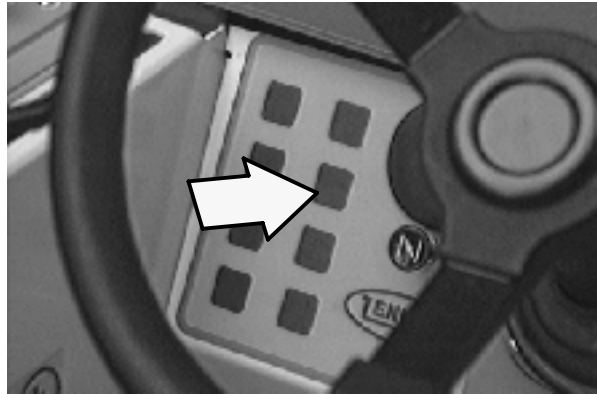
**HOPPER DOOR CLOSED LIGHT (OPTION)**

The hopper door closed light comes on when the hopper door is closed.

Make sure the hopper door is open all the way and the hopper door closed light is off, before sweeping.

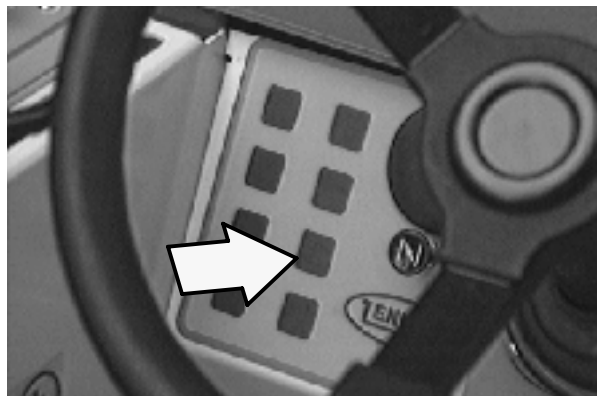

## OPERATION

### HYDRAULIC FILTER BYPASS LIGHT (OPTION)

The hydraulic filter bypass light comes on when the hydraulic filter is clogged. If this light comes on, have the hydraulic filter and hydraulic fluid changed as soon as possible.

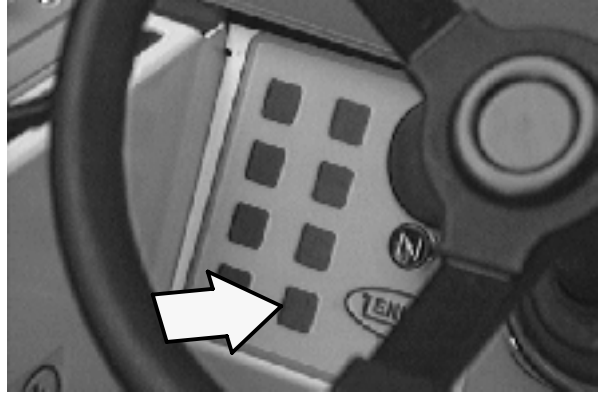

### FUEL LEVEL GAUGE

The fuel level gauge indicates how much fuel is in the fuel tank.

*NOTE: Do not let the fuel tank empty completely. Air can enter the fuel system and it may need bleeding before the next engine start.*

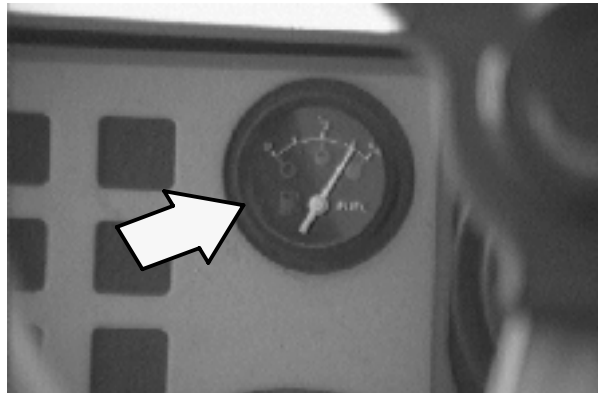

### STEERING WHEEL

The steering wheel controls the machine's direction. The machine is very responsive to the steering wheel movements.

Left: Turn the steering wheel to the left.

Right: Turn the steering wheel to the right.



### HOURMETER

The hourmeter records the number of hours the machine has been operated. The hourmeter displays the number of hours in tenths of an hour. Use this information to determine machine maintenance intervals.

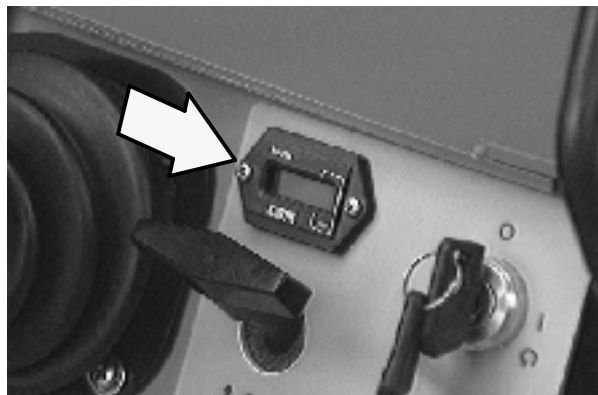

### STEERING WHEEL TILT HANDLE

The steering wheel tilt handle controls the angle of the steering wheel.

Adjust: Pull out the tilt handle, move the steering wheel up or down, and release the tilt handle.

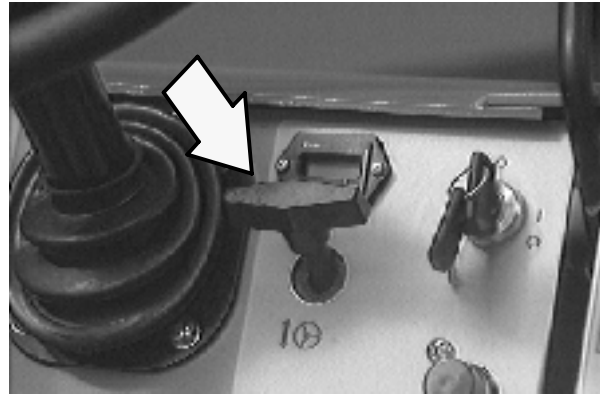

### IGNITION SWITCH

The ignition switch starts and stops the engine with a key.

**FOR SAFETY: When starting machine, keep foot on brake and directional pedal in neutral.**

Preheat: Turn the key all the way counterclockwise and hold it there until the glow plug light goes off.

Start: Turn the key all the way clockwise. Release the key as soon as the engine starts.

Stop: Turn the key counterclockwise.

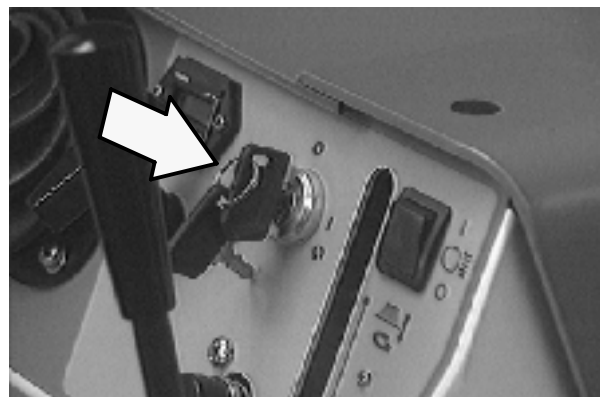

### HORN BUTTON

The horn button operates the horn.

Sound: Press the button.

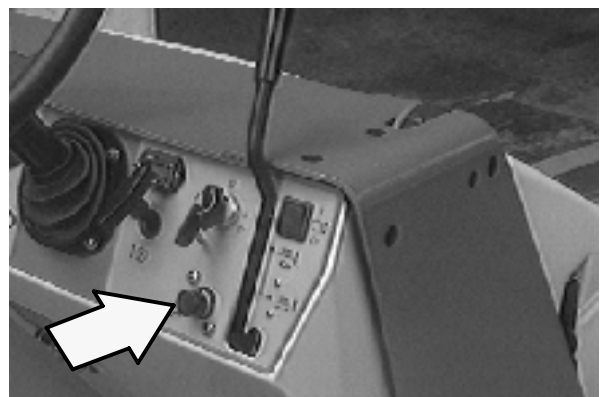

## OPERATION

### SIDE BRUSH LEVER

The side brush lever controls the position and rotation of the side brush.

Side brush down and on: Pull the lever back and to the left into the **Side brush down and on** position. The brush will automatically start rotating.

Side brush up and off: Pull the lever back and to the right into the **Side brush up and off** position.

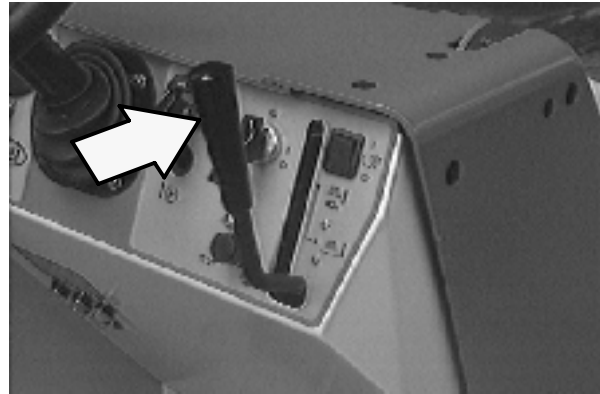

### OPERATING LIGHTS SWITCH

The operating lights switch powers on and off the headlights and taillights.

On: Press the top of the operating lights switch.

Off: Press the bottom of the operating lights switch.

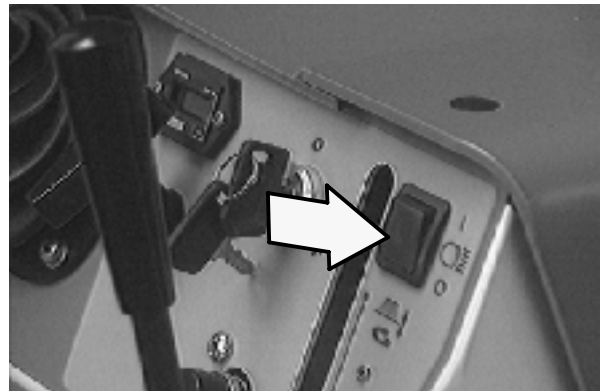

### OPERATING/HAZARD LIGHTS SWITCH (OPTION)

The operating/hazard lights switch powers on and off the headlights and taillights and the hazard light option.

Operating lights on: Press the top of the operating/hazard lights switch.

Operating/Hazard lights on: Press the bottom of the operating/hazard lights switch.

Off: Place operating/hazard lights switch in the middle position.

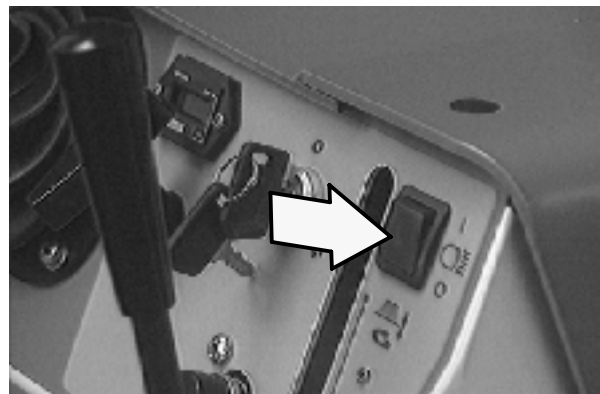

**SIDE BRUSH DOWN PRESSURE KNOB**

The side brush down pressure knob changes the side brush contact with the sweeping surface.

Increase: Turn the side brush down pressure knob counterclockwise.

Decrease: Turn the side brush down pressure knob clockwise.



**FUSES**

Fuses are one-time protection devices designed to stop the flow of current in the event of a circuit overload. Never substitute higher value fuses than specified.

The fuse is located behind the instrument panel.

Fuse	Rating	Circuit Protected
FU-1	30 A	Glow plugs

**CIRCUIT BREAKERS**

The circuit breakers are resettable electrical circuit protection devices. Their design stops the flow of current in the event of a circuit overload. Once a circuit breaker is tripped, it must be reset manually. Press the reset button after the breaker has cooled down.

If the overload that caused the circuit breaker to trip is still there, the circuit breaker will continue to stop current flow until the problem is corrected.

The circuit breakers are located in the operator compartment.

The chart lists the circuit breakers and the electrical components they protect.

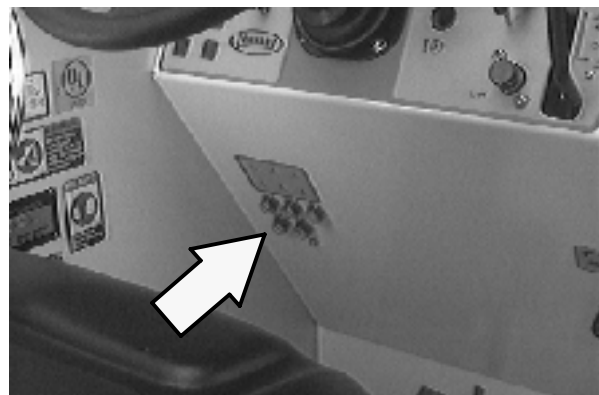

Circuit Breaker	Rating	Circuit Protected
CB-1	15 A	Thermo Sentry
CB-2	15 A	Hourmeter, engine, fuel level
CB-3	15 A	Hopper, brushes
CB-4	15 A	Operating lights
CB-5	15 A	Horn

## OPERATION

### OPERATOR SEAT

The operator seat is a fixed back style with a forward-backward adjustment.

Adjust: Pull the lever in, slide the seat backward or forward to the desired position, and release the lever.

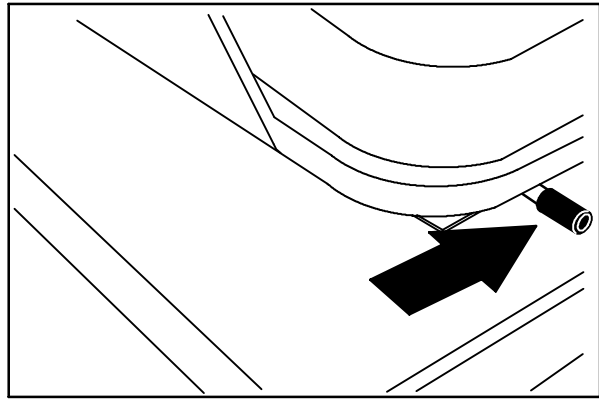

350015

### DELUXE SUSPENSION SEAT (OPTION)

The deluxe suspension seat has three adjustments. The adjustments are for the operator's weight, backrest angle, and the front-to-rear seat position.

The operator's weight adjustment lever controls the seat weight adjustment. The lever has three positions: lightweight, middleweight, and heavyweight.

Adjust: Pull the lever up for the lightweight position, move the lever to the middle position for middleweight, and push the lever down for the heavyweight position.

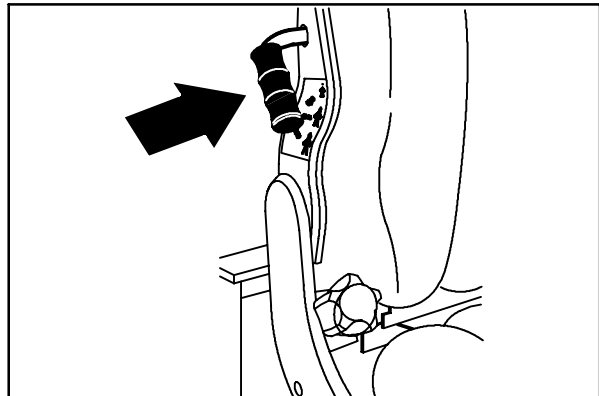

07795

The backrest angle knob adjusts the backrest angle.

Adjust: Turn the angle knob clockwise to decrease the angle of the backrest. Turn the knob counterclockwise to increase the angle of the backrest.

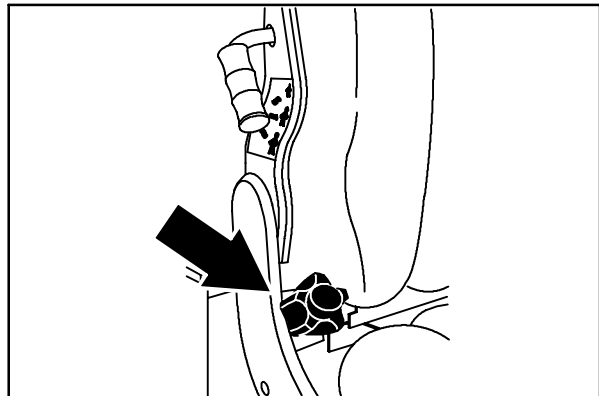

07796

The seat front-to-rear position lever adjusts the seat position.

Adjust: Pull the lever out, slide the seat backward or forward to the desired position and release the lever.

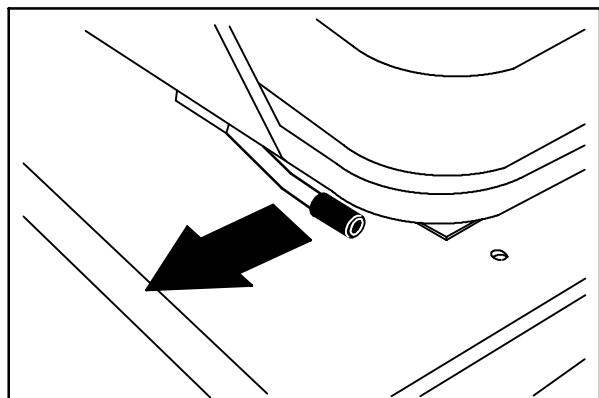

07797



## HOPPER SUPPORT BAR

The hopper support bar is located on the operator's side of the hopper lift arms. The hopper support bar holds the hopper in the raised position to allow work under the hopper. DO NOT rely on the machine hydraulic system to keep the hopper raised.



**WARNING: Raised hopper may fall.  
Engage hopper support bar.**

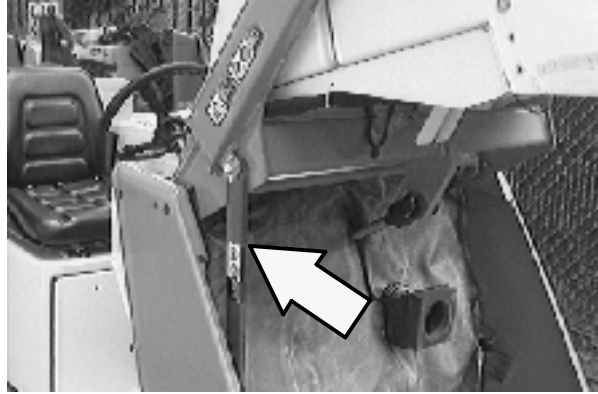

## HOW THE MACHINE WORKS

---

The steering wheel controls the direction of machine travel. The directional pedal controls the speed and forward/reverse direction. The brake pedal slows and stops the machine.

The side brush sweeps debris into the path of the main sweeping brush. The main brush sweeps debris from the floor into the hopper. The vacuum system pulls dust and air through the hopper and the hopper dust filter.

When sweeping is finished, clean the hopper dust filter and empty the hopper.

## PRE-OPERATION CHECKLIST

---

- Check the engine oil level.
- Check the engine coolant level.
- Check the windshield washer fluid level (when applicable).
- Check the radiator and hydraulic cooler fins for debris.
- Check the hydraulic fluid level
- Check the air filter indicator.
- Check the skirts and seals for damage and wear.
- Check the condition of the sweeping brushes. Remove any string, banding, plastic wrap, or other debris wrapped around them.
- Check the sweeping brush patterns for adjustment.
- Check the condition of the hopper dust filter and seals. Clean as required.
- Check the brakes and steering for proper operation.
- Check the fuel level
- Empty the debris hopper.
- Check the service records to determine maintenance requirements.

---

**STARTING THE MACHINE**

---

1. Sit in the operator's seat and engage the brakes with the directional pedal in neutral.

**FOR SAFETY: When starting machine, keep foot on brake and directional pedal in neutral.**

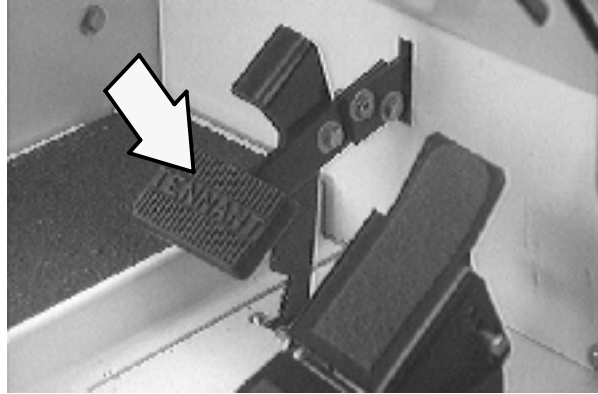

2. Move the throttle lever back into the **Idle engine speed** position.

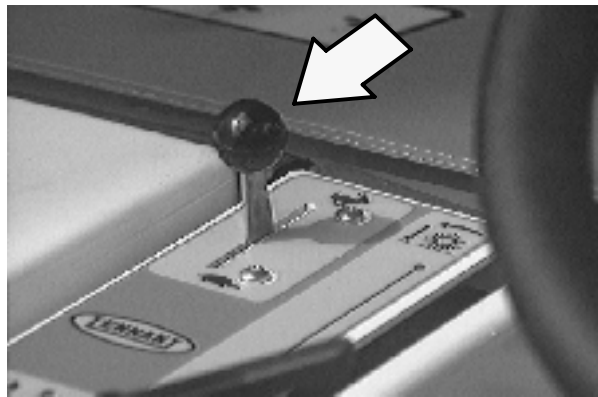

3. Turn the ignition switch key counterclockwise. The glow plug light will come on. When the glow plug light goes out, the engine is ready to start.

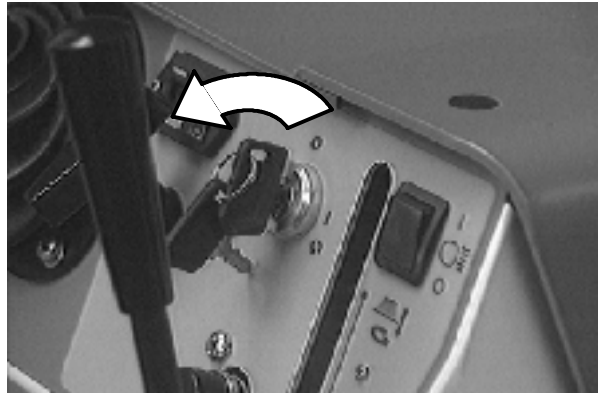

4. Turn the ignition switch key clockwise until the engine starts.

*NOTE: Do not operate the starter motor for more than 10 seconds at a time or after the engine has started. Allow the starter to cool between starting attempt or damage to the starter motor may occur.*

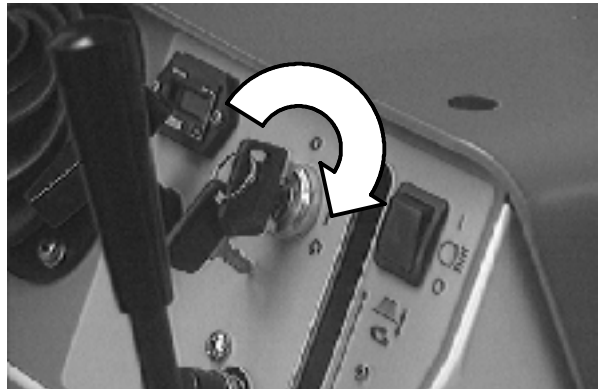

## OPERATION

5. Allow the engine and hydraulic system to warm up three to five minutes.



**WARNING: Engine emits toxic gases. Severe respiratory damage or asphyxiation can result. Provide adequate ventilation. Consult with your regulatory authorities for exposure limits. Keep engine properly tuned.**

6. Move the throttle lever forward into the **Fast engine speed** position.

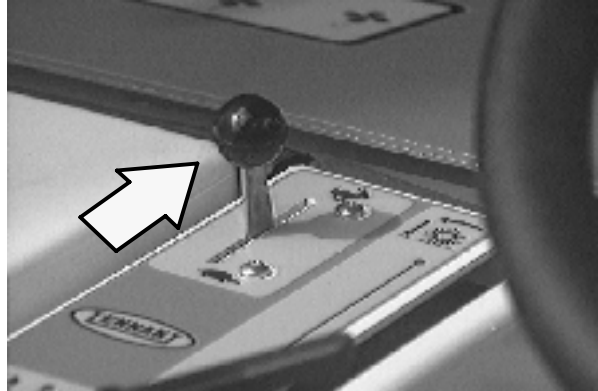

7. Release the machine parking brake.

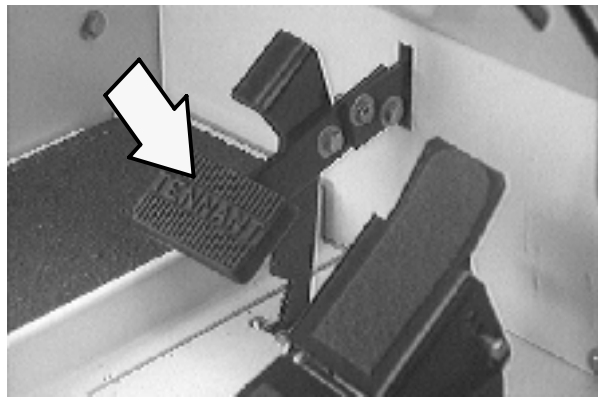

8. Drive the machine to the area to be cleaned.

---

## SWEEPING AND BRUSH INFORMATION

---

Pick up oversized debris before sweeping. Flatten or remove bulky cartons from aisles before sweeping. Pick up pieces of wire, twine, string, etc., which could become entangled in the brush or brush plugs.

*NOTE: Debris can be placed in the hopper through the hopper access door on the front of the hopper.*

Plan the sweeping in advance. Try to arrange long runs with minimum stopping and starting. Sweep debris from very narrow aisles into the main aisles ahead of time. Do an entire floor or section at one time. Drive the straightest path possible. Avoid bumping into posts or scraping the sides of the machine. Overlap the brush paths.

Avoid turning the steering wheel too sharply when the machine is in motion. The machine is very responsive to the movement of the steering wheel. Avoid sudden turns, except in emergencies.

For best results, use the correct brush type for your sweeping application. The following are recommendations for main sweeping and side brush applications.

***Polypropylene 8-double row main brush*** – Superior pick-up of sand, gravel, and paper litter. Polypropylene retains its stiffness when wet and can be used indoors or outdoors with equal performance. Not recommended for high-temperature debris.

***Polypropylene and wire 8-double row main brush*** – The wire bristles loosen slightly packed soilage and heavier debris. The polypropylene bristles sweep up the debris with excellent hopper loading.

***Polyester 8-double row main brush*** – Polyester combines the durability of nylon with the moisture resistance of polypropylene.

***Polyester 24-single row main brush*** – Polyester combines the durability of nylon with the moisture resistance of polypropylene. This high density brush is recommended for applications that sweep heavy accumulations of fine dust, sand or other similar material.

***Natural Fiber 8-double row main brush*** – The natural choice for cleaning fine debris on carpet and sweeping very heavy dust and other fine particles on hard surfaces.

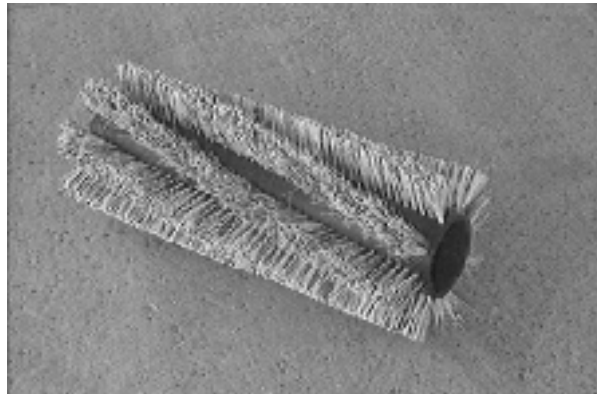

## OPERATION

**Polypropylene Side Brush** – A good general purpose brush for sweeping of light to medium debris in both indoor and outdoor applications. This brush is recommended when bristles may get wet.

**Nylon Side Brush** – A longer life, general purpose brush that is recommended for rough surfaces.

**Flat Wire Side Brush** – Recommended for outside and curb-side sweeping where soilage is heavy or compacted. The stiff wire bristles dig out soilage. This brush is also recommended for foundry sweeping where heat may melt synthetic bristles.



## SWEEPING

1. Move the throttle lever all the way forward into the **Fast engine speed** position.

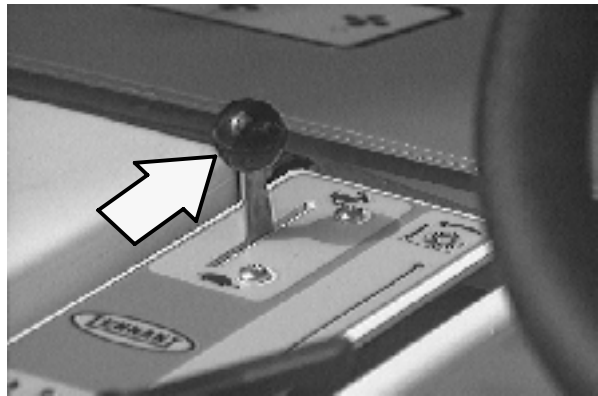

2. Push the hopper door lever forward into the **Hopper door open** position to open the hopper door.

*NOTE: If the machine is equipped with the hopper door closed light option, the light will be off when the hopper door is open.*



3. Move the vacuum and filter shaker lever to the **Vacuum fan on** position.

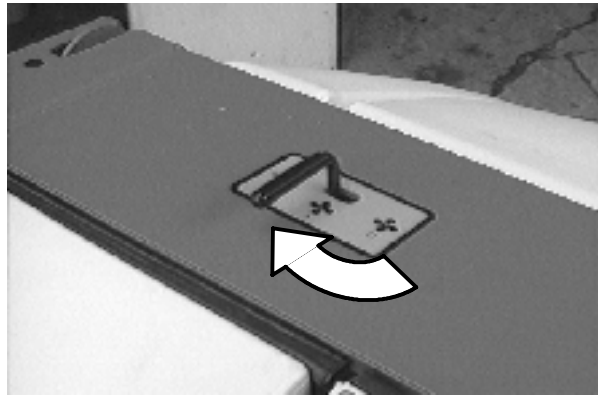

4. Lower and start the main brush with the main brush lever.



5. Lower and start the side brush with the side brush lever.



6. Sweep as needed.

### STOP SWEEPING

1. Raise and stop the side brush with the side brush lever.

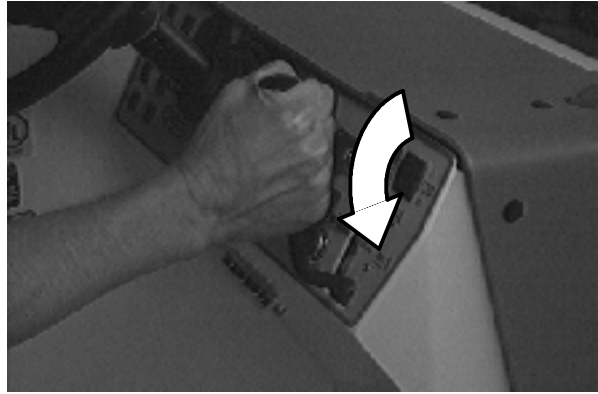

2. Raise and stop the main brush with the main brush lever.

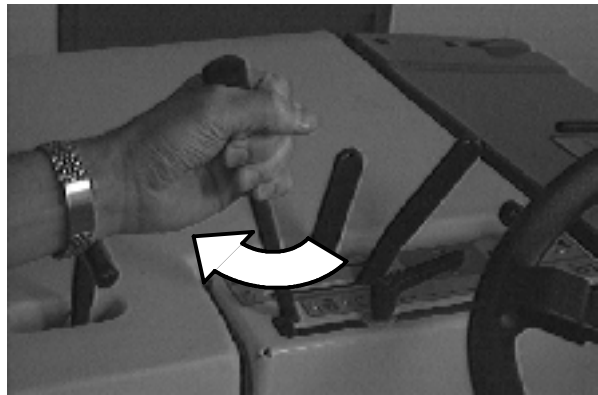

3. Shake the dust filter by holding the vacuum and filter shaker lever in the **Filter shaker** position for 30 seconds.

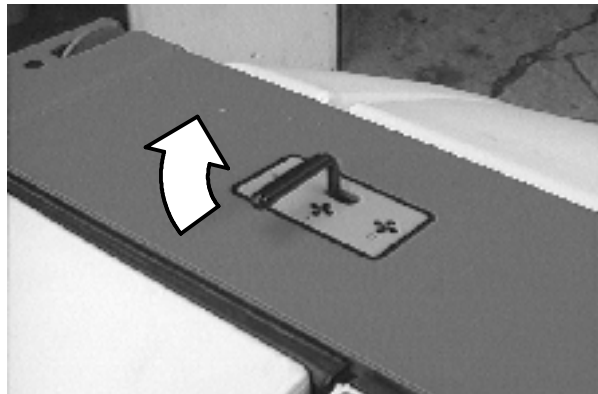



## EMPTYING THE HOPPER

1. Stop sweeping.
2. Pull and hold the hopper door lever back into the **Hopper door close** position until the hopper door is closed. Then release the hopper door lever.

*NOTE: If the machine is equipped with the hopper door closed light option, the light will come on when the hopper door is closed.*

3. Slowly drive the machine to the debris site or debris container.
4. Pull and hold the hopper lever back into the **Hopper up** position to raise the hopper to the desired height. Release the hopper lever into the **Hold** position.

**FOR SAFETY: When using machine, make sure adequate clearance is available before raising hopper.**

*NOTE: Be aware that the minimum ceiling height needed to high dump the hopper is 2340 mm (92 in).*

**FOR SAFETY: When using machine, move machine with care if hopper is raised.**

5. Drive the machine up to the debris container. Position the hopper over the debris container.
6. Move the vacuum and filter shaker lever into the **Vacuum fan off** position.

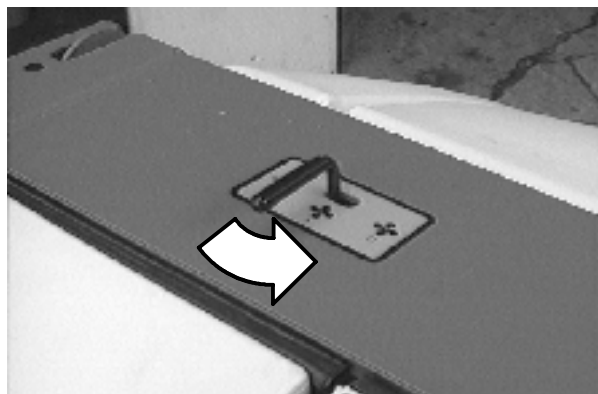
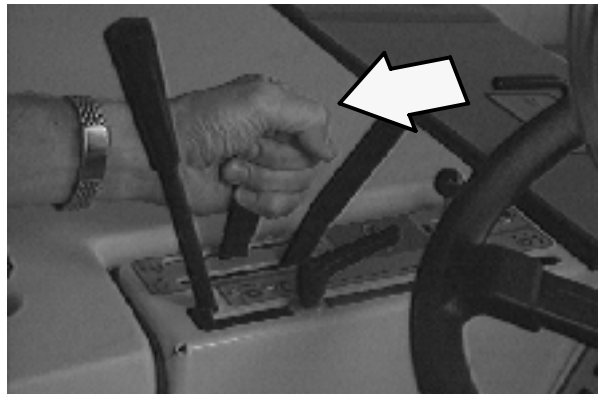

## OPERATION

7. Push the hopper door lever forward into the **Hopper door open** position to open the hopper door.

*NOTE: If the machine is equipped with the hopper door closed light option, the light will be off when the hopper door is open.*



8. Pull the hopper door lever back into the **Hopper door close** position to close the hopper door after the hopper is empty.

*NOTE: If the machine is equipped with the hopper door closed light option, the light will come on when the hopper door is closed.*



9. Slowly back the machine away from the debris site or debris container.

**FOR SAFETY: When using machine, use care when reversing machine.**

10. Push and hold the hopper lever forward into the **Hopper down** position to lower the hopper. Release the hopper lever into the **Hold** position.

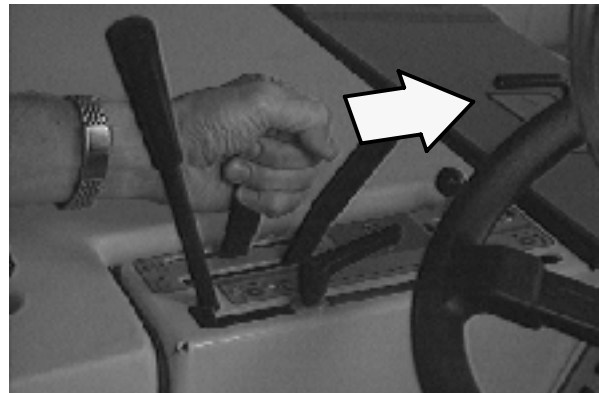

11. Push the hopper door lever forward into the **Hopper door open** position to open the hopper door.

*NOTE: If the machine is equipped with the hopper door closed light option, the light will be off when the hopper door is open.*



12. Move the vacuum and filter shaker lever into the **Vacuum fan on** position.

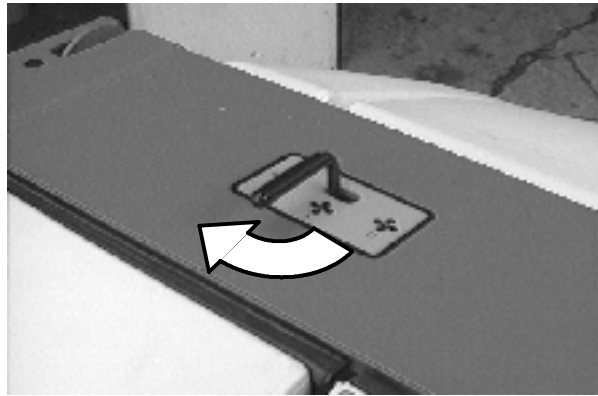

---

### STOP THE MACHINE

---

1. Stop sweeping.
2. Take your foot off the directional pedal. Step on the brake pedal.

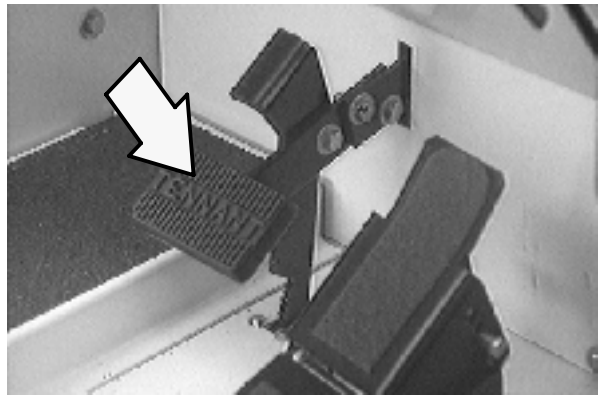

3. Move the throttle lever back into the **Idle engine speed** position.

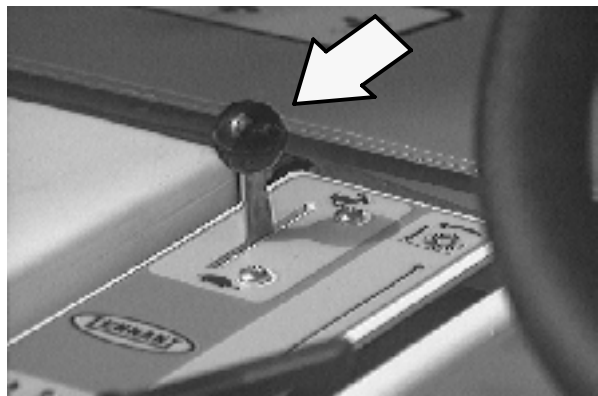

4. Set the machine parking brake.

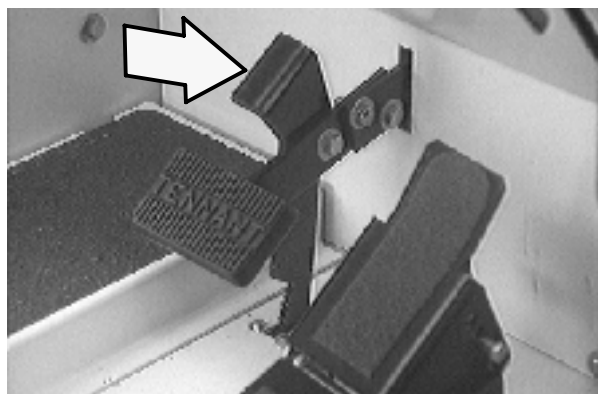

## OPERATION

5. Turn the ignition switch key counterclockwise to stop the engine. Remove the switch key.

**FOR SAFETY: Before leaving or servicing machine, stop on level surface, set parking brake, turn off machine, and remove key.**

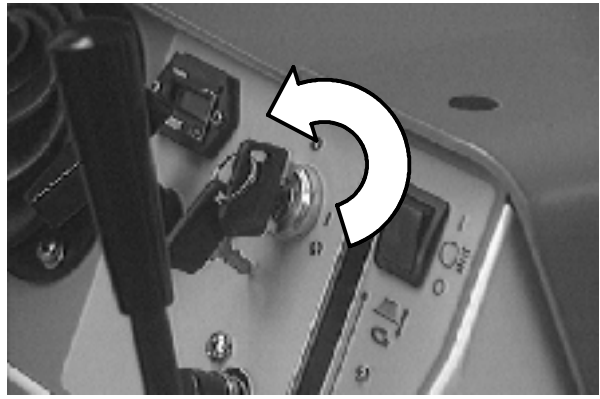

---

**POST-OPERATION CHECKLIST**

---

Check this list of items after you have finished sweeping:

- Check the engine oil level.
- Check the engine coolant level.
- Check the windshield washer fluid level (when applicable).
- Check the radiator and hydraulic cooler fins for debris.
- Check the hydraulic fluid level
- Check the air filter indicator.
- Check the skirts and seals for damage and wear.
- Check the condition of the sweeping brushes. Remove any string, banding, plastic wrap, or other debris wrapped around them.
- Check the sweeping brush patterns for adjustment.
- Check the condition of the hopper dust filter and seals. Clean as required.
- Check the brakes and steering for proper operation.
- Check the fuel level
- Empty the debris hopper.
- Check the service records to determine maintenance requirements.

### ENGAGING HOPPER SUPPORT BAR

1. Set the machine parking brake.

**FOR SAFETY: When starting machine, keep foot on brake and directional pedal in neutral.**

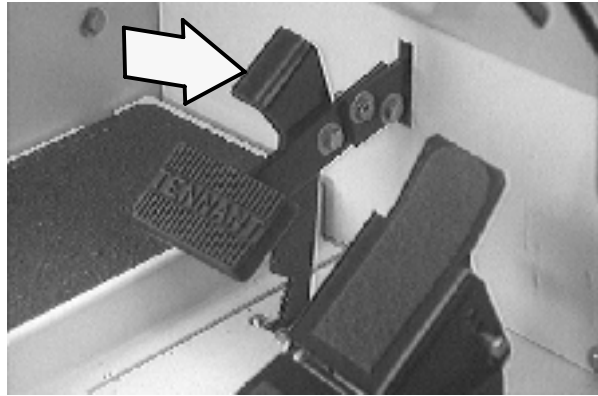

2. Start the engine.

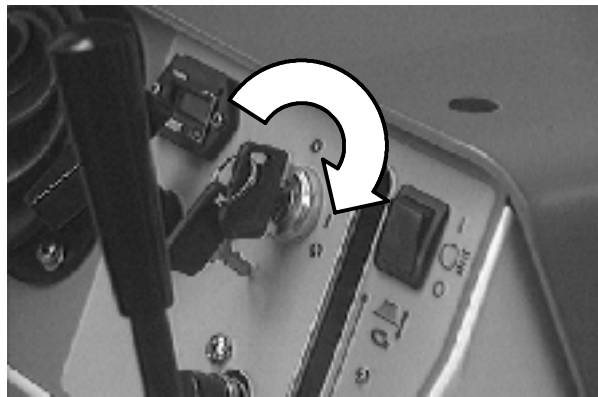

3. Move the throttle lever all the way forward into the **Fast engine speed** position.

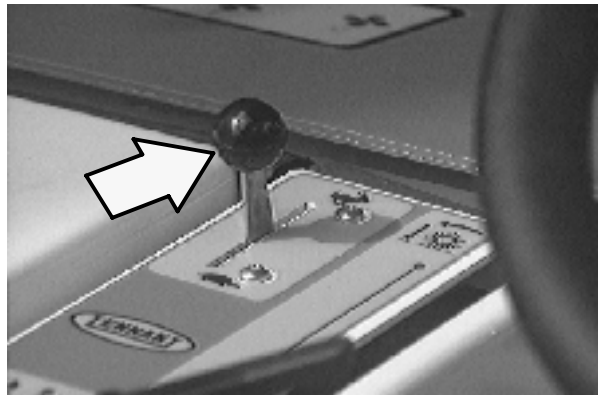

4. Pull and hold the hopper lever back into the **Hopper up** position to raise the hopper. Release the hopper lever into the **Hold** position.

**FOR SAFETY: When using machine, make sure adequate clearance is available before raising hopper.**

*NOTE: Be aware that the minimum ceiling height needed to high dump the hopper is 2340 mm (92 in).*

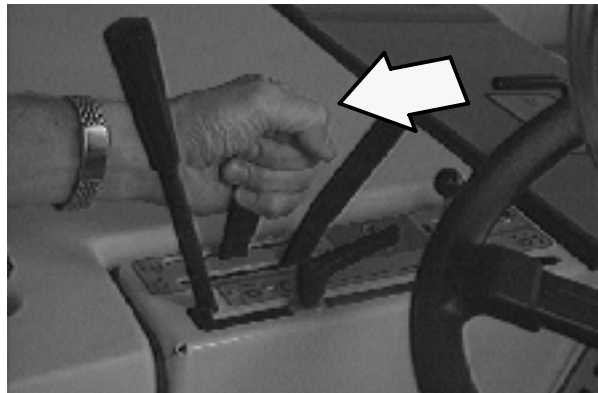

- Lower and position the hopper support bar onto the support bar stop.

 **WARNING: Raised hopper may fall. Engage hopper support bar.**

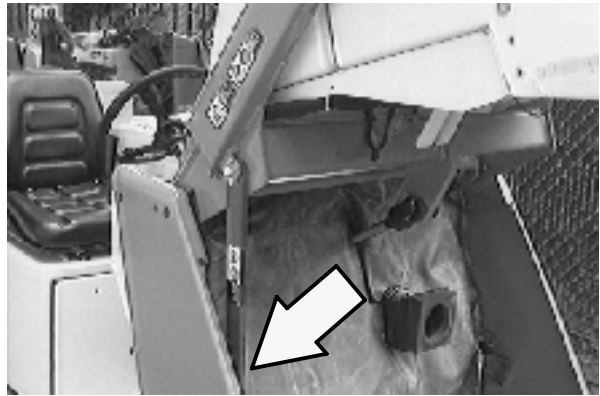

- Slowly lower the hopper so the hopper support bar rests on the support bar stop.

 **WARNING: Lift arm pinch point. Stay clear of hopper lift arms.**

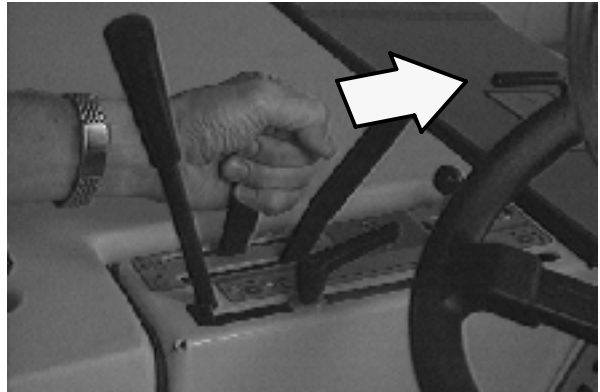

- Move the throttle lever back into the **Idle engine speed** position.

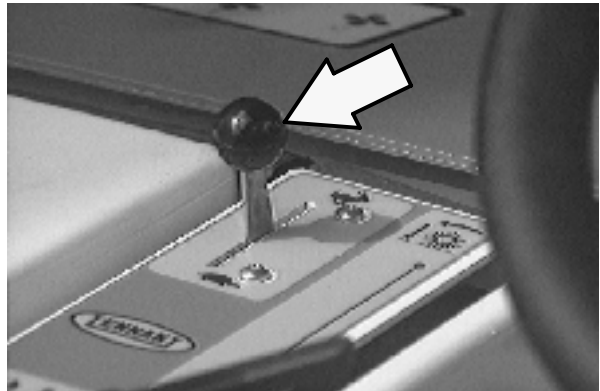

- Shut the engine off.

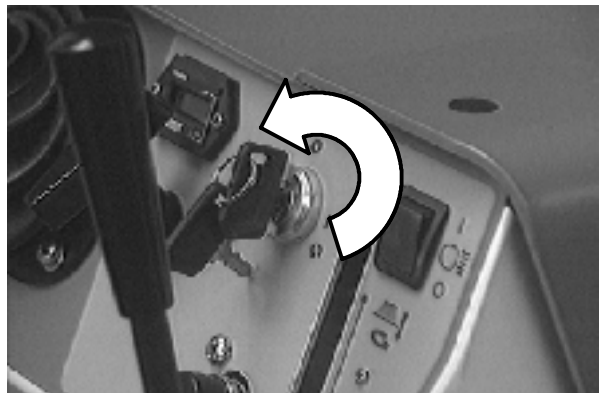

## DISENGAGING HOPPER SUPPORT BAR

1. Start the engine.

**FOR SAFETY:** When starting machine, keep foot on brake and directional pedal in neutral.

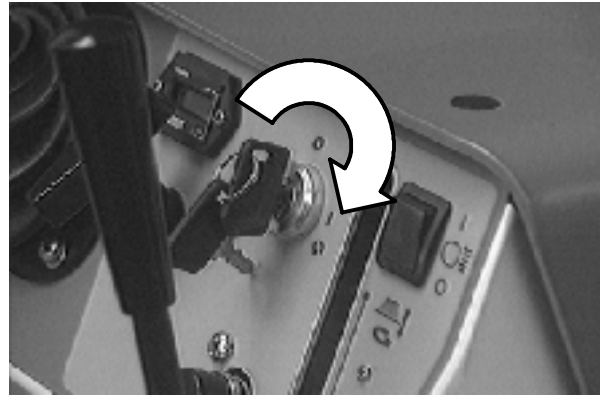

2. Move the throttle lever all the way forward into the **Fast engine speed** position.

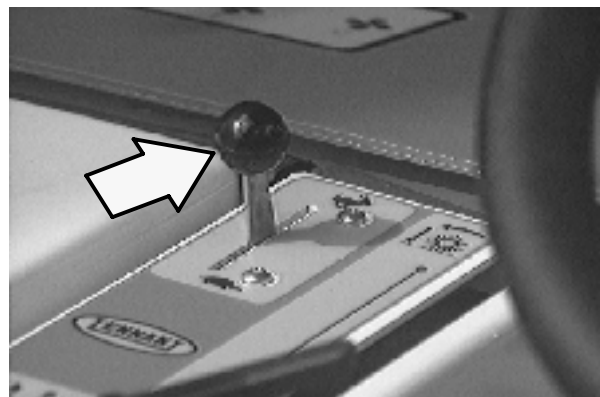

3. Pull and hold the hopper lever back into the **Hopper up** position to raise the hopper slightly.

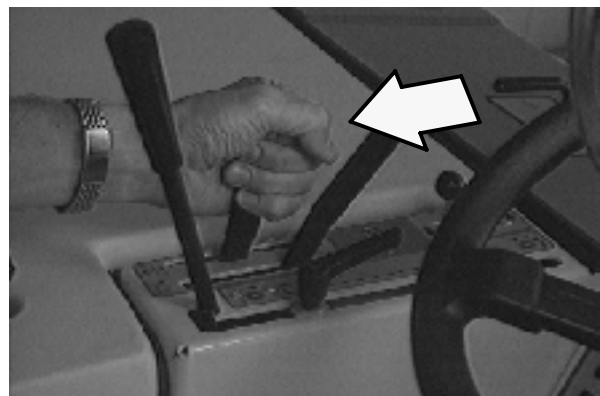

4. Put the support bar in its storage position.

**WARNING:** Lift arm pinch point. Stay clear of hopper lift arms.





5. Lower the hopper.

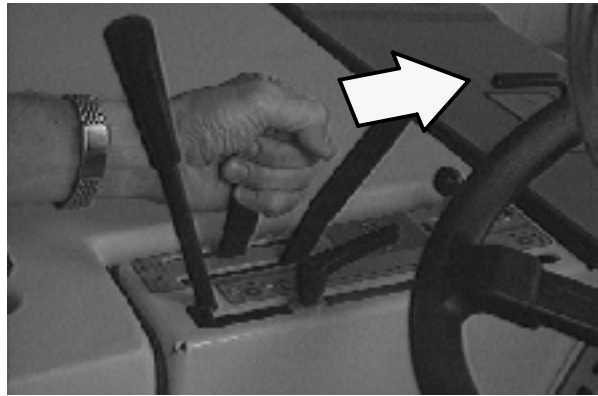

6. Move the throttle lever back into the **Idle engine speed** position.

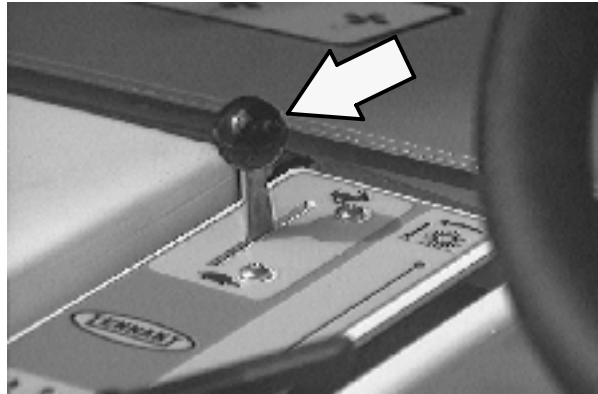

7. Shut the engine off.

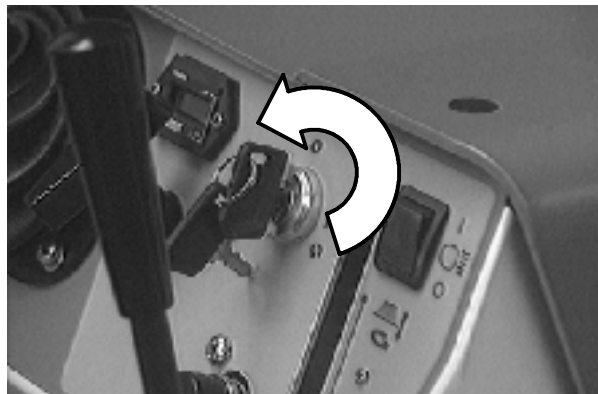

---

### OPERATION ON INCLINES

---

Drive the machine slowly on inclines. Use the brake pedal to control machine speed when descending inclines.

The maximum rated incline is 8° or 14.1% with a full hopper and 10° or 17.6% with an empty hopper.

**FOR SAFETY: When using machine, go slowly on inclines and slippery surfaces.**

## OPTIONS

### VACUUM WAND

The vacuum wand uses the machine's vacuum system. The vacuum hose and wand allow pick-up of debris that is out of reach of the machine.

1. Stop the machine within reach of the area to be vacuumed.
2. Set the machine parking brake and turn the engine off.
3. Remove the vacuum wand and hose from the mounting clips.

4. Connect the vacuum hose to the vacuum wand.
5. Remove the plug from the side of the hopper.

6. Connect the other end of the vacuum hose to the hopper hose connector.

7. Start the engine.

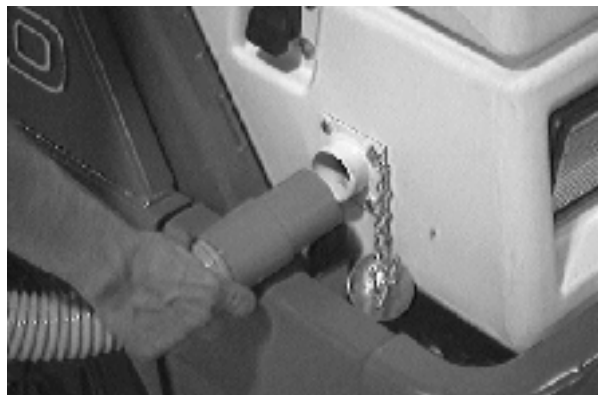
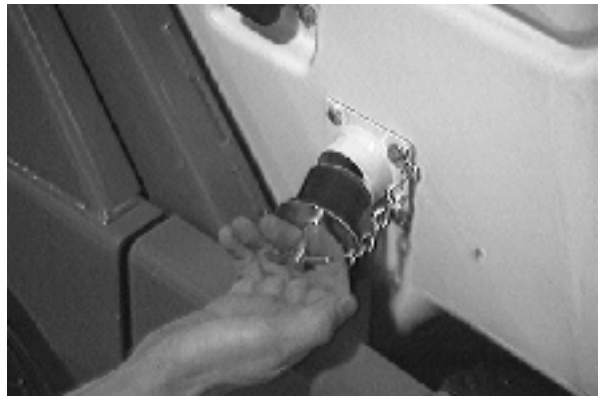

8. Move the throttle lever all the way forward into the **Fast** position.

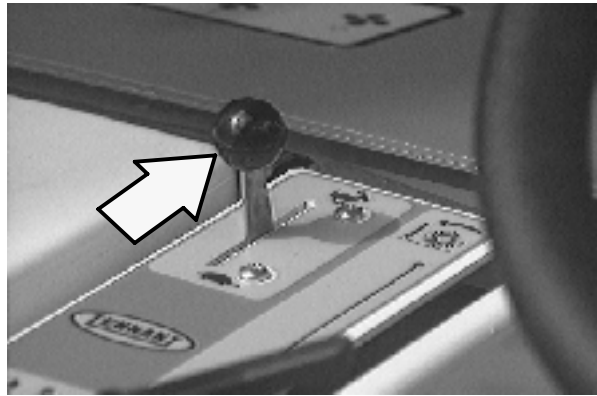

9. Pull and hold the hopper door lever back into the **Hopper door close** position until the hopper door is closed.

*NOTE: If the machine is equipped with the hopper door closed light option, the light will come on when the hopper door is closed.*

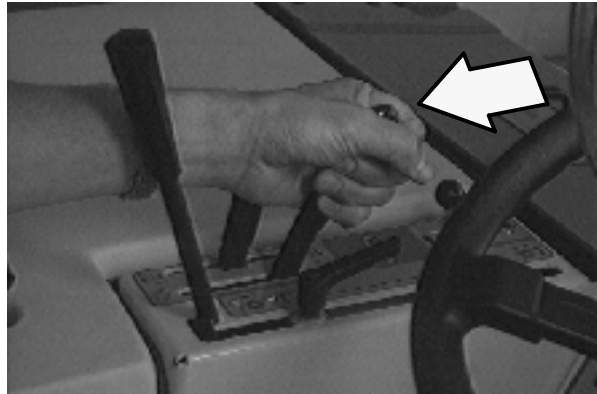

10. Move the vacuum and filter shaker lever into the **Vacuum fan on** position.
11. Vacuum the area as needed.
12. When finished, push the hopper door lever forward into the **Hopper door open** position to open the hopper door.
13. Shut the engine off.
14. Remove the vacuum hose from the hopper connection.
15. Replace the plug in the side of the hopper.
16. Disconnect the vacuum hose from the vacuum wand.
17. Put the vacuum wand and hose in the mounting clips.

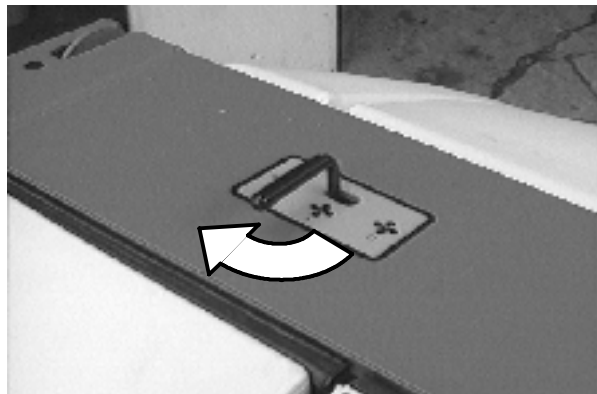

## MACHINE TROUBLESHOOTING

Problem	Cause	Remedy
Excessive dusting	Vacuum fan off	Move vacuum and filter shaker lever to <b>Vacuum fan on</b> position
	Brush skirts and dust seals worn, damaged, out of adjustment	Replace or adjust brush skirts or dust seals
	Hopper dust filter clogged	Shake and/or clean or replace dust filter
	Vacuum hose damaged	Replace vacuum hose
	Vacuum fan failure	Contact TENNANT service personnel
	Thermo Sentry tripped	Reset Thermo Sentry
	Hopper door partially or completely closed	Open hopper door
Poor sweeping performance	Brush bristles worn	Replace brushes
	Main and side brushes not adjusted properly	Adjust main and side brushes
	Debris caught in main brush drive mechanism	Remove debris from the drive mechanism.
	Main brush drive failure	Contact TENNANT service personnel
	Side brush drive failure	Contact TENNANT service personnel
	Hopper full	Empty hopper
	Hopper lip skirts worn or damaged	Replace lip skirts
	Hopper door partially or completely closed	Open hopper door
	Wrong sweeping brush	Contact TENNANT representative for recommendations
	Recirculation flap damaged	Replace flap



**MAINTENANCE**

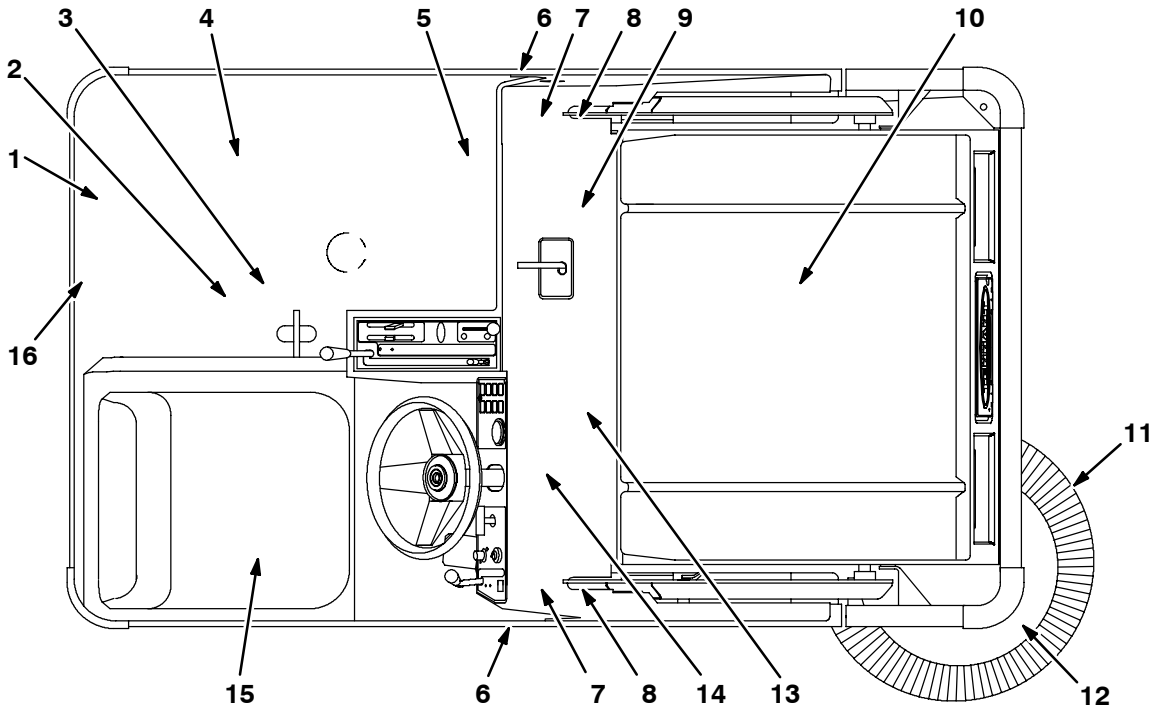

350158

**MAINTENANCE CHART**

*NOTE: Check procedures indicated (■) after the first 50 hours of operation.*

Interval	Key	Description	Procedure	Lubricant/ Fluid	No. of Service Points
Daily	4	Engine	Check oil level	EO	1
			Empty air filter dust cap	-	1
			Check optional air filter indicator	-	1
	6	Brush compartment skirts	Check for damage, wear and adjustment	-	5
	12	Hopper lip skirts	Check for damage, wear and adjustment	-	3
	9	Main brush	Check for damage or wear	-	1
			Check brush pattern	-	1
	11	Side brush	Check for damage or wear	-	1
Check brush pattern			-	1	
50 Hours	10	Hopper dust filter	Shake	-	1
	9	Main brush	Rotate end-for-end	-	1
	4	Fuel pipes and clamps	Check for tightness and wear	-	All

Interval	Key	Description	Procedure	Lubricant/ Fluid	No. of Service Points
100 Hours	10	Hopper dust filter	Check for damage, clean or re- place	-	1
	15	Hydraulic fluid reservoir	Check fluid level	HYDO	1
	7	Tires	Check for damage	-	3
			Check pressure	-	1
	13	Main brush and hopper seals	Check for damage or wear	-	8
	1	Radiator	Clean core exterior	-	1
			Check coolant level	WG	1
	4	Engine	■Change oil and filter element	EO	1
			Check belt tension	-	1
			Clean or replace filter element	-	1
5	Battery	■Check electrolyte	DW	1	
200 Hours	2	Rear wheel support bear- ings	Lubricate	SPL	2
	1	Radiator hoses and clamps	Check for tightness and wear	-	2
	14	Brakes	Check and adjust travel	-	1
	3	Steering cylinder	Lubricate	SPL	1
	4	Vacuum fan belt	Check tension and wear	-	1
	12	Side brush guard	Rotate 90°	-	1
	8	Hopper lift arm pivots	Lubricate	SPL	2
	12	Side brush pivot	Check adjustment	-	1
400 Hours	4	Fuel filter cartridge	Replace element	-	1
	7	Front wheel bearings	Check for seal damage	-	2
800 Hours	15	Hydraulic fluid reservoir	Replace filler cap	-	1
			Replace suction strainer	-	1
			Change hydraulic fluid	HYDO	1
	16	Hydraulic fluid filter	Change filter element	-	1
	-	Hydraulic hoses	Check for wear and damage	-	All
	3	Propelling motor	■Torque shaft nut	-	1
	3	Rear wheel	■Torque wheel nuts	-	1
	5	Battery	■Clean and tighten battery cable connections	-	1
	4	Engine	Check valve clearance	-	1
1	Cooling system	Flush	WG	1	

**LUBRICANT/FLUID**

DW . . . Distilled water

EO . . . Engine oil, SAE-CD/CE rated

HYDO . Tennant or approved hydraulic fluid

SPL . . . Special lubricant, Lubriplate EMB grease (TENNANT part no. 01433-1)

WG . . . Water and permanent-type ethylene glycol anti-freeze, -34° C (-30° F)

*NOTE: More frequent intervals may be required in extremely dusty conditions.*

## LUBRICATION

### ENGINE

Check the engine oil level daily. Change the engine oil and oil filter after every 100 hours of machine operation. Use 10W30 SAE-CD/CE rated engine oil.

Fill the engine with oil to the level indicated on the oil dipstick. Low oil level is indicated by the mark closest to the end of the dipstick. Full level is indicated by the mark closest to the top of the dipstick. The engine oil capacity is 5.1 L (5.4 qt) including the oil filter.

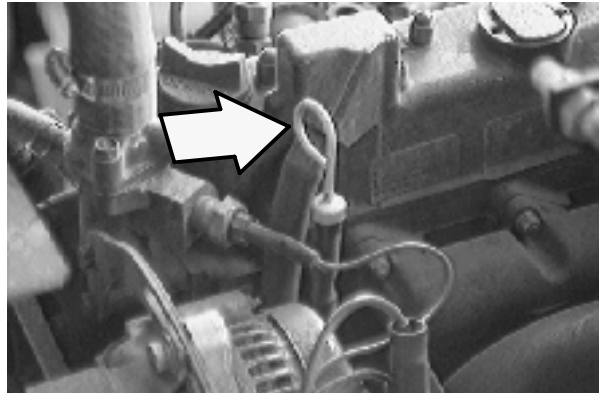

### REAR WHEEL SUPPORT

The rear wheel support pivots the rear wheel. The support has two grease fittings for the bearings. The rear wheel support bearings must be lubricated every 200 hours of operation. Use Lubriplate EMB grease (Tennant part no. 01433-1).

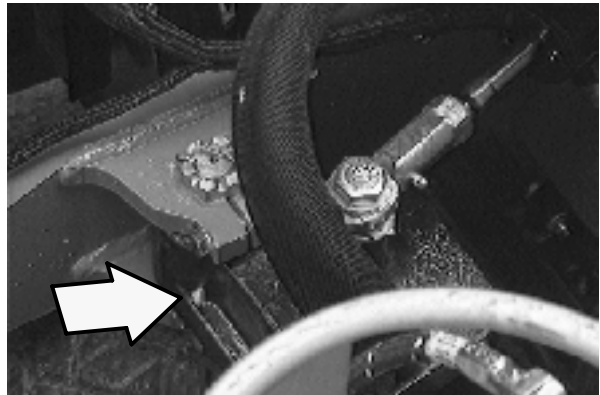

### STEERING CYLINDER

The steering cylinder has one grease fitting on the rear wheel support end of the cylinder.

Lubricate with Lubriplate EMB grease (Tennant part number 01433-1) after every 200 hours of machine operation.

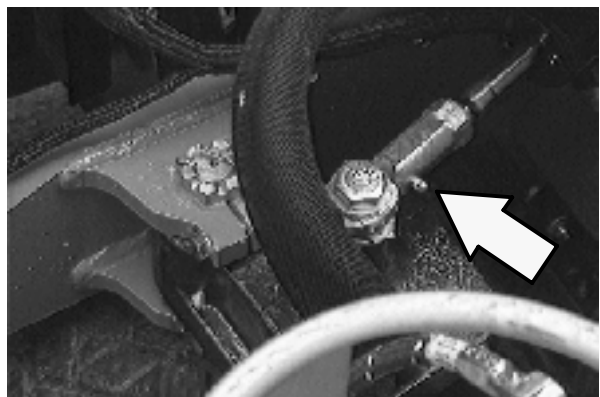



**FRONT WHEEL BEARINGS**

Inspect the front wheel bearings for seal damage after every 400 hours of operation. Replace bearings when necessary.

**HOPPER LIFT ARM PIVOTS**

The hopper lift arms have two grease fittings, one on each lift arm.

Lubricate with Lubriplate EMB grease (Tennant part number 01433-1) after every 200 hours of machine operation.



## HYDRAULICS

### HYDRAULIC FLUID RESERVOIR

The reservoir is located in the engine compartment.

A filler cap is mounted on top of the reservoir. It has a built-in breather and fluid level dipstick. Replace the cap after every 800 hours of operation.

Check the hydraulic fluid level at operating temperature after every 100 hours of operation. Make sure the hopper is down when checking hydraulic fluid level. The end of the dipstick is marked with FULL and ADD levels to indicate the level of hydraulic fluid in the reservoir.

Lubricate the filler cap gasket with a film of hydraulic fluid before putting the cap back on the reservoir.

**ATTENTION! Do not overfill the hydraulic fluid reservoir or operate the machine with a low level of hydraulic fluid in the reservoir. Damage to the machine hydraulic system may result.**

Drain and refill the hydraulic fluid reservoir with new hydraulic fluid after every 800 hours of operation.

The hydraulic fluid filter is located under the radiator. Replace the filter element after every 800 hours of operation.

*NOTE: If the machine is equipped with the hydraulic filter bypass light option, and the light comes on, replace the filter as soon as possible.*

The reservoir has a built-in strainer outlet that filters hydraulic fluid before it enters the system. Replace the strainer after every 800 hours of operation.

### HYDRAULIC FLUID

The quality and condition of the hydraulic fluid play a very important role in how well the machine operates. Tennant's hydraulic fluid is specially selected to meet the needs of Tennant machines.

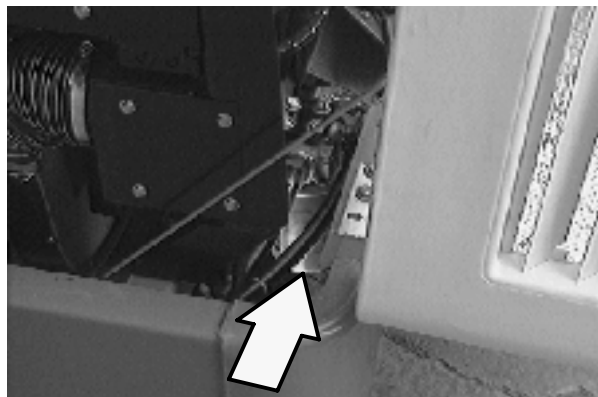
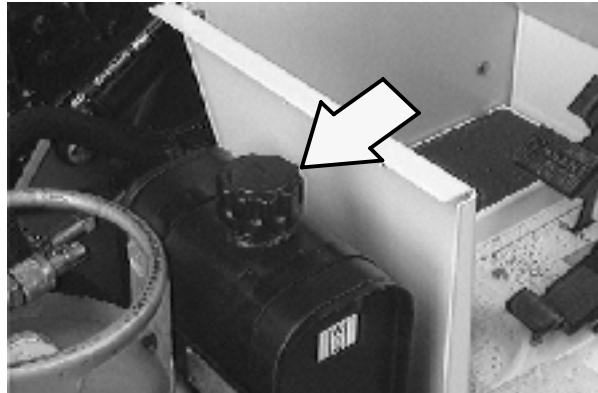

Tennant's hydraulic fluids provide a longer life for the hydraulic components. There are two fluids available for different temperature ranges:

<b>Tennant hydraulic fluid</b>	
Part number	Ambient temperature
65869	above 7° C (45° F)
65870	below 7° C (45° F)

The higher temperature fluid has a higher viscosity and should not be used at the lower temperatures. Damage to the hydraulic pumps may occur because of improper lubrication.

The lower temperature fluid is a thinner fluid for colder temperatures.

If a locally available hydraulic fluid is used, make sure the specifications match Tennant hydraulic fluid specifications. Using substitute fluids can cause premature failure of hydraulic components.

**ATTENTION! Hydraulic components depend on system hydraulic fluid for internal lubrication. Malfunctions, accelerated wear, and damage will result if dirt or other contaminants enter the hydraulic system.**

**HYDRAULIC HOSES**

Check the hydraulic hoses after every 800 hours of operation for wear or damage.

Fluid escaping at high pressure from a very small hole can be almost invisible, and can cause serious injuries.

See a doctor at once if injury results from escaping hydraulic fluid. Serious infection or reaction can develop if proper medical treatment is not given immediately.

**FOR SAFETY: When servicing machine, use cardboard to locate leaking hydraulic fluid under pressure.**

If you discover a fluid leak, contact your mechanic or supervisor.

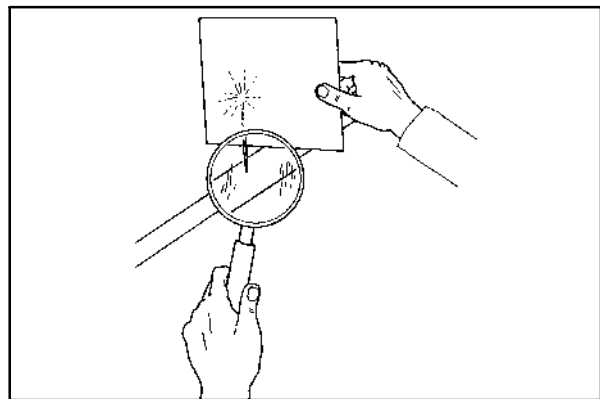

00002

**PROPELLING MOTOR**

Torque the shaft nut to 270 Nm (200 ft lb) after the first 50 hours of operation and after every 800 hours thereafter.

## ENGINE

### COOLING SYSTEM

Check the radiator coolant level after every 100 hours of operation. Use clean water mixed with a permanent-type, ethylene glycol antifreeze to a  $-34^{\circ}\text{C}$  ( $-30^{\circ}\text{F}$ ) rating.

**FOR SAFETY: When servicing machine, avoid contact with hot engine coolant.**

Check the radiator hoses and clamps after every 200 hours of operation. Tighten the clamps if they are loose. Replace the hoses and clamps if the hoses are cracked, hardened, or swollen.

Check the radiator core exterior and for debris after every 100 hours of operation. Blow or rinse all dust, which may have collected on the radiator, in through the grille and radiator fins, opposite the direction of normal air flow. Be careful not to bend the cooling fins when cleaning. Clean thoroughly to prevent the fins becoming encrusted with dust. Clean the radiator and cooler only after the radiator has cooled to avoid cracking.

**FOR SAFETY: When servicing machine, wear eye and ear protection if using pressurized air or water.**

Flush the radiator and the cooling system after every 800 hours of operation, using a dependable cleaning compound.

### AIR FILTER INDICATOR (OPTION)

The optional air filter indicator shows when to replace the air filter element. Check the indicator daily. The indicator's red line will move as the air filter element fills with dirt. Do not replace the air filter element until the red line reaches 5 kPa (20 in  $\text{H}_2\text{O}$ ) and the "SERVICE WHEN RED" window is filled with red. The indicator's red line may return to a lower reading on the scale when the engine shuts off. The red line will return to a correct reading after the engine runs for a while.

Reset the air filter indicator by pushing the reset button on the end of the indicator after replacing the air filter element.

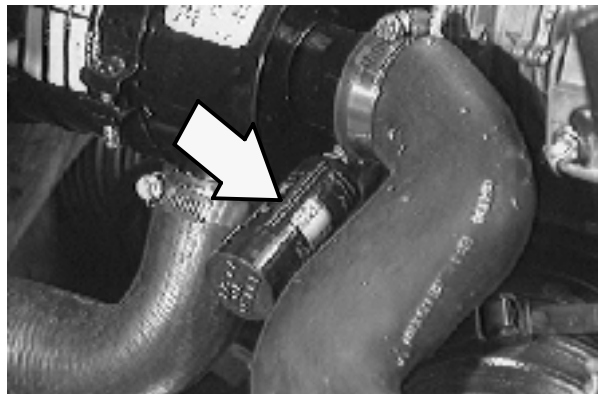
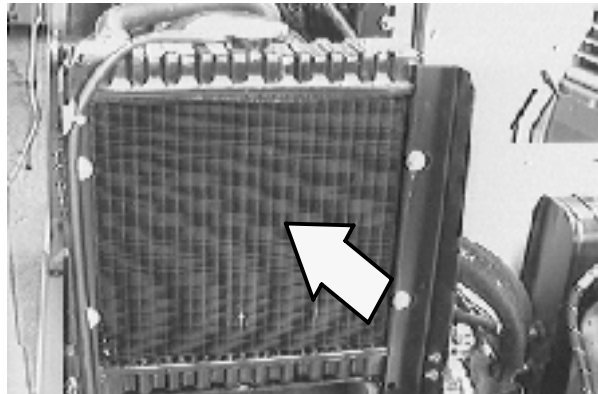
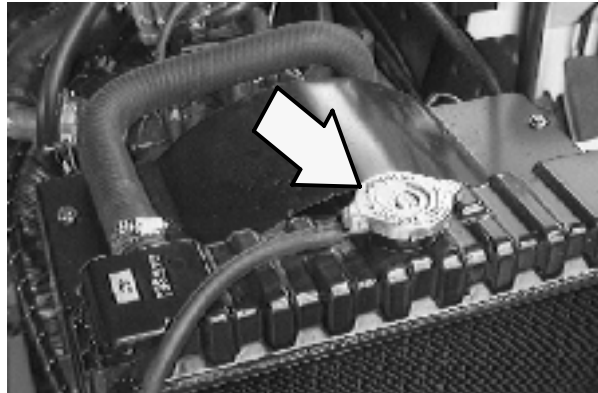

**AIR FILTER**

The engine air filter housing has a dust cap and a dry cartridge-type air filter element. They are located in front of the engine compartment under the lintel. Empty the dust cap daily.

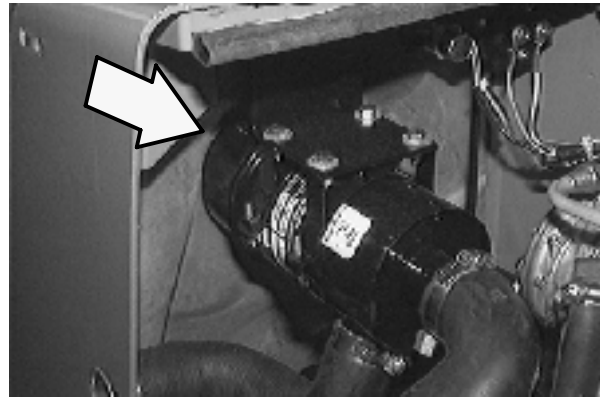

Install the dust cap on the air filter housing with the arrows pointing up.

Replace the air filter element after every 100 hours of operation, or when the optional air filter indicator shows restriction in the air intake system. The air filter must be replaced whenever the filter element is damaged.

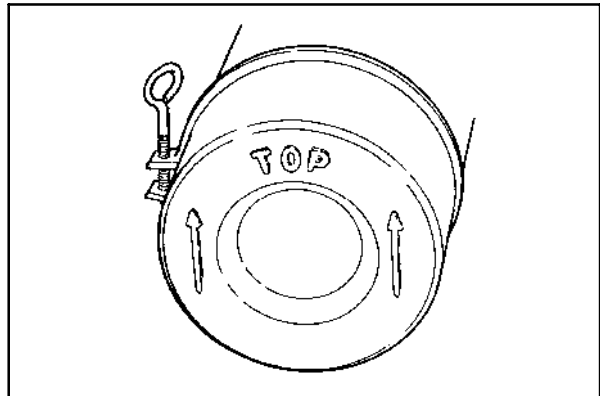

02492

To remove the filter element, raise the hopper and engage the hopper support bar. Set the parking brake and turn the engine off. Remove the top two dust skirt clips with a needle-nosed pliers. Pull back the dust skirt to access the air filter housing.

**⚠ WARNING: Raised hopper may fall. Engage hopper support bar.**

**FOR SAFETY: Before leaving or servicing machine, stop on level surface, set parking brake, turn off machine, and remove key.**

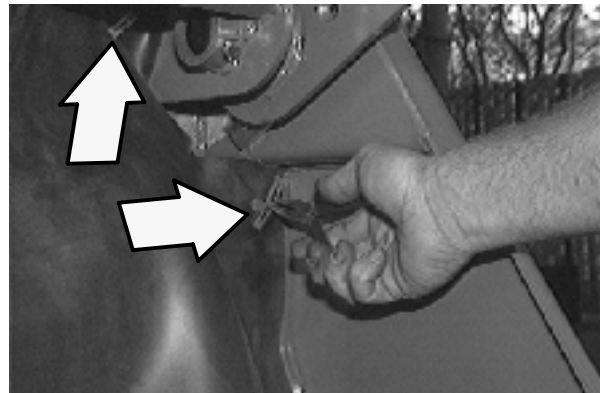

To clean the air filter housing, remove the filter element. Carefully clean the end cap and the interior of the housing with a damp cloth. Clean the housing sealing surfaces.



### FUEL FILTERS

The fuel filter cartridge protects the engine from impurities in the fuel. This filter is located behind the radiator.

Replace the fuel filter element after every 400 hours of operation.

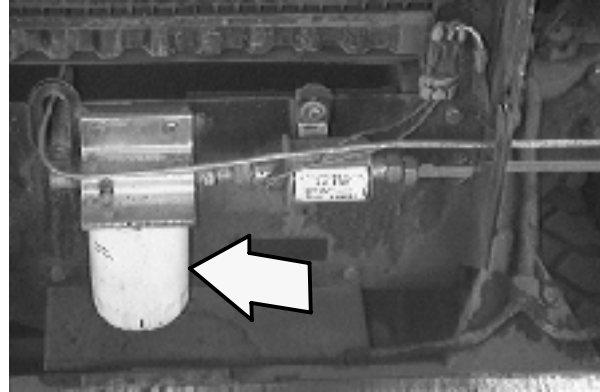

### FUEL LINES

Check the fuel lines after every 50 hours of operation. If the clamp band is loose, apply oil to the band screw and retighten the band.

The fuel lines contain rubber parts and can deteriorate whether the engine has been used or not. Replace the fuel lines and clamp bands after every two years.

If the fuel lines and clamp bands are worn or damaged, replace or repair them at once. Bleed the fuel system after replacing any of the fuel lines -- see *PRIMING THE FUEL SYSTEM*. While servicing the fuel lines, plug fuel line ends with clean cloth or paper to prevent contamination which can cause fuel injection pump malfunction.

**PRIMING THE FUEL SYSTEM**

Priming the fuel system removes pockets of air in the fuel lines and fuel components. Air in the fuel system will cause rough engine operation.

Prime the fuel system after running out of fuel, changing fuel filter elements, or repairing a fuel system component.

1. Stop the engine and set the machine parking brake.

**FOR SAFETY: Before leaving or servicing machine, stop on level surface, set parking brake, turn off machine, and remove key.**

2. Fill the fuel tank.
3. Open the seat support.

**FOR SAFETY: When servicing machine, allow engine to cool. Keep flames and sparks away from fuel system service area. Keep area well ventilated.**

4. Open the air vent on top of the fuel filter.
5. Start the engine, operate it for one minute, then stop it; or operate the starter motor in ten-second intervals until a steady stream of fuel flows from the vent.
6. Close the air vent.

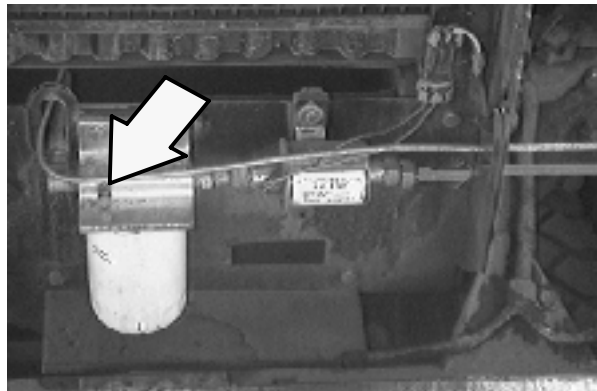

7. Open the air vent on top of the fuel injection pump.
8. Start the engine, operate it for one minute, then stop it; or operate the starter motor in ten-second intervals until a steady stream of fuel flows from the vent.
9. Close the air vent.
10. Close the seat support.

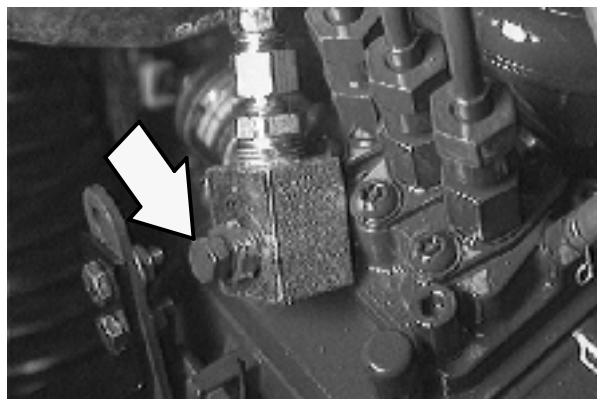

**VALVE CLEARANCE**

Check and adjust the valve clearance to 0.145 to 0.185 mm (0.0057 to 0.0072 in) while the engine is cold after every 800 hours of operation.

## ELECTRICAL

---

### BATTERY

The battery for the machine is a low maintenance battery. Do not add water to the battery, or remove the battery vent plugs.

The battery is located in the engine compartment.

After the first 50 hours of operation, and after every 800 hours after that, clean and tighten the battery connections. Check the battery electrolyte level after every 100 hours of operation.

**FOR SAFETY: When servicing machine, avoid contact with battery acid.**

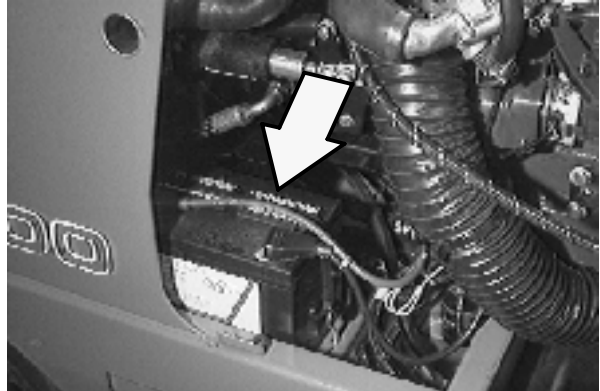



**BELTS AND CHAINS**

**ENGINE BELT**

The engine belt is driven by the engine crankshaft pulley and drives the engine water pump and alternator pulleys. Proper belt tension is obtained when the belt deflects 7 to 9 mm (0.28 to 0.35 in) from a force of 10 kg (22 lb) applied at the mid-point of the longest span.

Check and adjust the belt tension after every 100 hours of operation.



**WARNING: Moving belt and fan. Keep away.**

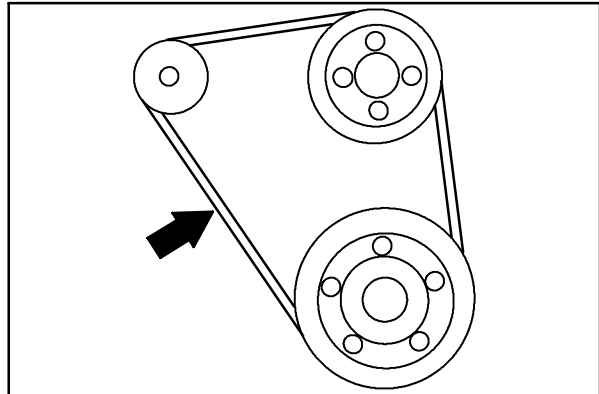

08935

**VACUUM FAN BELT**

Check the vacuum fan belt tension and wear after every 200 hours of operation. The correct tension is when the belt deflects 4 mm (0.16 in) from a force of 0.7 kg (1.5 lb) at belt midpoint.



**WARNING: Moving belt and fan. Keep away.**

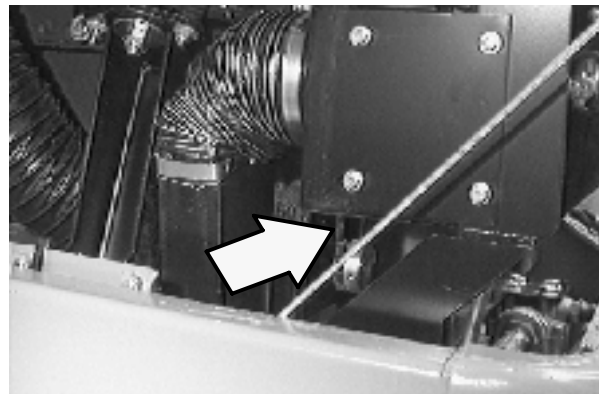

**STATIC DRAG CHAIN**

A static drag chain prevents the buildup of static electricity in the machine. The chain is attached to the machine by a rear main brush skirt retaining bolt.

Make sure the chain is touching the floor at all times.

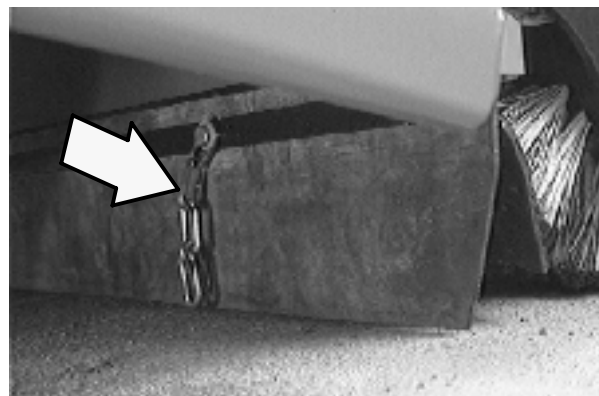

## DEBRIS HOPPER

---

### HOPPER DUST FILTER

The dust filter filters the air pulled up from the hopper. The dust filter is equipped with a shaker to remove the accumulated dust particles. The dust filter shaker is operated by the vacuum and filter shaker lever.

The standard dust filter works well for normal sweeping applications. The synthetic filter works well for humid or wet applications.

Shake the dust filter before emptying the hopper and at the end of every work shift. Check and clean or replace the dust filter after every 100 hours of operation.

To clean the dust filter, use one of the following methods:

- **SHAKING** – Move the vacuum and filter shaker lever to the **Filter shaker** position.
- **TAPPING** – Tap the filter gently on a flat surface with the dirty side down. Do not damage the edges of the filter element and seals, or the filter will not seat properly in the filter frame.
- **AIR** – Always wear eye protection when using compressed air. Blow air through the dust filter opposite the direction of the arrows. Never use more than 690 kPa (100 psi) of air pressure and never closer than 50 mm (2 in) away from the filter. This may be done with the dust filter in the machine.

**FOR SAFETY: When servicing machine, wear eye and ear protection if using pressurized air or water.**

- **WATER** – Rinse the synthetic filter with a low pressure garden hose through the dust filter opposite the direction of the arrows. The standard dust filter can also be rinsed, but the filter will degrade with each rinsing and should be replaced after rinsing five times.

*NOTE: Be sure the dust filter is completely dry before reinstalling it in the machine.*



**REMOVING HOPPER DUST FILTER**

1. Stop the engine and set the machine parking brake.

**FOR SAFETY: Before leaving or servicing machine, stop on level surface, set parking brake, turn off machine, and remove key.**

2. Unlatch and open the hopper cover. Support the hopper with the hopper cover prop rod.



3. Lift the dust filter element out of the hopper insert.



4. Clean or discard the dust filter as required.
5. Clean and inspect the filter sealing surfaces. Make sure the foam element centering strips attached to the hopper are intact. Put the cleaned or new dust filter in the hopper insert with the arrows pointing up.
6. Lower the hopper cover support and close the hopper cover. Latch the hopper cover.

## BRUSHES

### MAIN BRUSH

The main brush is cylindrical and spans the width of the machine, sweeping debris into the hopper.

Check the brush daily for wear or damage. Remove any string or wire tangled on the main brush, main brush drive hub, or main brush idler hub.

Check the main brush pattern daily. The pattern should be 50 to 75 mm (2 to 3 in) wide with the main brush in the lowered position. Adjust the main brush pattern by turning the main brush down pressure knob and moving the brush stop.

Rotate the main brush end-for-end after every 50 hours of operation for maximum brush life and best sweeping performance.

Replace the brush when it no longer cleans effectively.

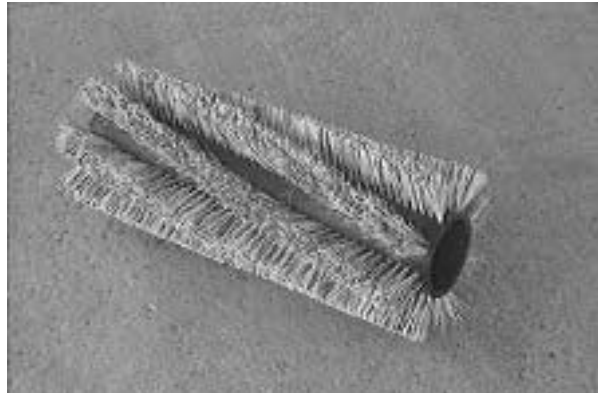

### REPLACING MAIN BRUSH

1. Stop the machine, set the parking brake and turn the engine off.

**FOR SAFETY: Before leaving or servicing machine, stop on level surface, set parking brake, turn off machine, and remove key.**

2. Lower the main brush.
3. Open the right side main brush access door.
4. Loosen the idler arm mounting T-bolt. Remove the brush idler arm assembly.
5. Grasp the main brush; pull it off the brush drive plug and out of the main brush compartment.
6. Put the new or rotated end-for-end main brush on the floor next to the access door.
7. Slide the main brush onto the drive plug. Rotate the brush until it engages the drive plug, and push it all the way onto the plug.
8. Slide the main brush idler arm plug onto the main brush.



9. Secure the idler arm on the pins. Hand tighten the mounting T-bolt.
10. Close the main brush access door.

**CHECKING AND ADJUSTING MAIN BRUSH PATTERN**

1. Apply chalk, or some other material that will not blow away easily, to a smooth, level floor.
2. Raise the side brush and main brush and position the main brush over the chalked area.
3. Lower the main brush for 15 to 20 seconds while keeping a foot on the brakes to keep the machine from moving.

*NOTE: If chalk or other material is not available, allow the brushes to spin on the floor for two minutes. A polish mark will remain on the floor.*

4. Raise the main brush.
5. Drive the machine off of the test area.
6. Observe the width of the brush pattern. The proper brush pattern width is 50 to 75 mm (2 to 3 in).

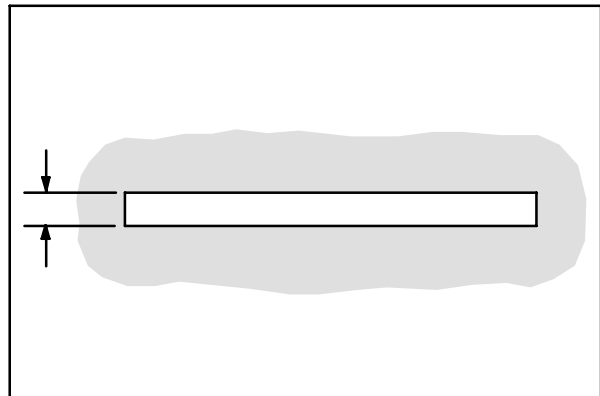
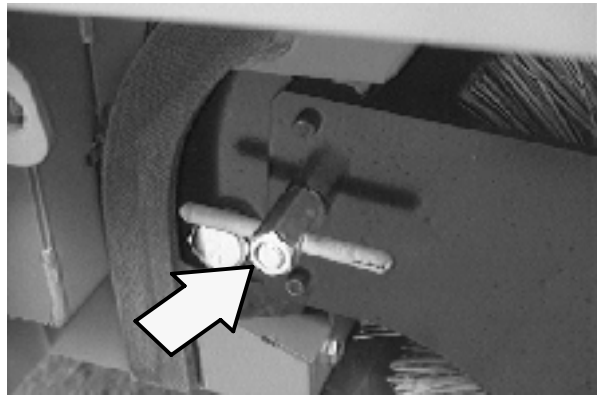

00582

## MAINTENANCE

7. To increase the width of the main brush pattern, move the main brush down pressure knob forward, away from the operator.

To decrease the width of the main brush pattern, move the main brush down pressure knob backward, towards the operator.

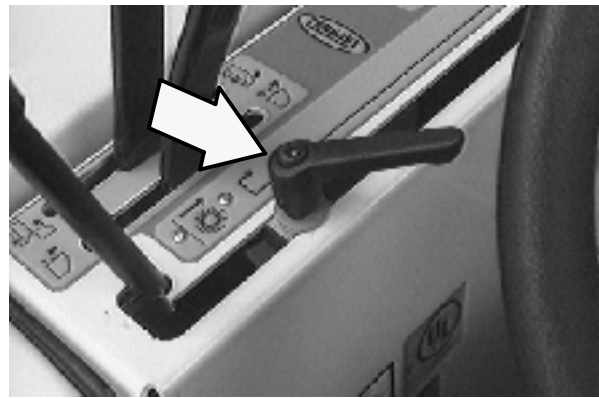

The brush taper is factory set and should not need adjustment unless parts of the brush system have been replaced.

If the main brush pattern is tapered, more than 15 mm (0.5 in) on one end than the other, adjust the taper as follows:

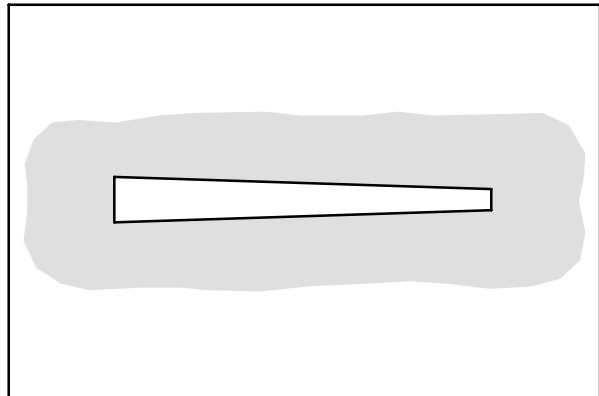

00601

- A. Loosen the brush shaft bearing bracket mounting bolts.
- B. Move the brush shaft bearing bracket up or down in the slots.
- C. Check the main brush pattern and readjust as necessary. Then adjust the width of the main brush pattern.

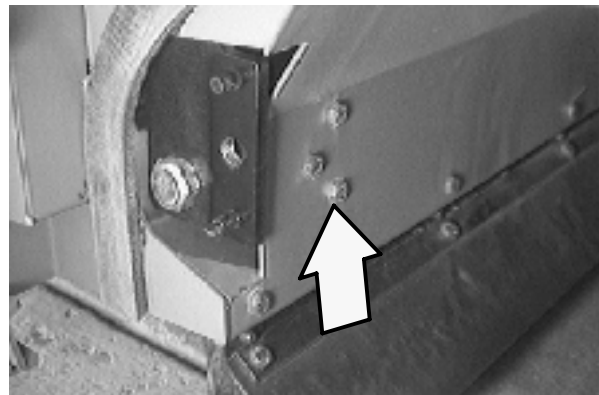

**SIDE BRUSH**

The side brush sweeps debris along edges into the path of the main brush.

Check the brush daily for wear or damage. Remove any string or wire found tangled on the side brush or side brush drive hub.

Check the side brush pattern daily. The side brush bristles should contact the floor in a 10 o'clock to 3 o'clock pattern when the brush is in motion. Adjust the side brush pattern by the side brush down pressure knob. Turn the knob counterclockwise to increase the brush contact with the sweeping surface and clockwise to decrease the brush contact with the sweeping surface.

Replace the brush when it no longer cleans effectively.

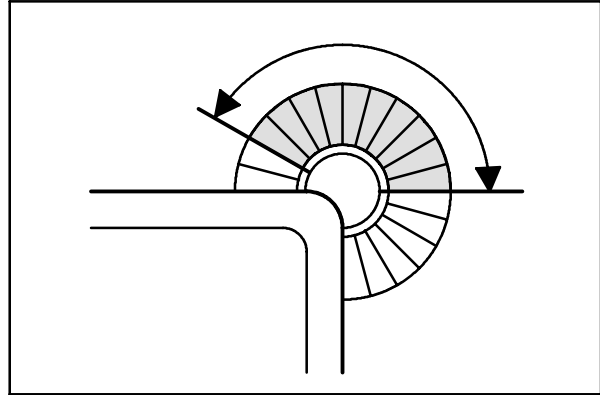

350327

**REPLACING SIDE BRUSH**

1. Stop the machine, set the parking brake and turn the engine off.

**FOR SAFETY: Before leaving or servicing machine, stop on level surface, set parking brake, turn off machine, and remove key.**

2. Remove the side brush retaining pin from the side brush drive shaft by pulling the pin keeper off over the end of the pin.
3. Slide the side brush off the side brush drive shaft.

*NOTE: Remove the drive hub and put it on the new brush if one is not installed.*

4. Slide the new side brush onto the side brush drive shaft.
5. Insert the side brush retaining pin through the side brush hub and shaft.
6. Secure the pin by clipping the pin keeper over the end of the pin.
7. Adjust the side brush pattern with the side brush down pressure knob.

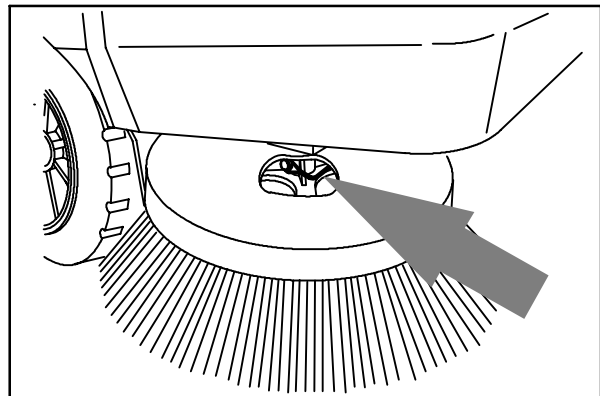

08019

## MAINTENANCE

### SIDE BRUSH GUARD

Rotate the side brush guard 90° after every 200 hours of operation, or sooner if worn. Replace the brush guard after using all four sides.

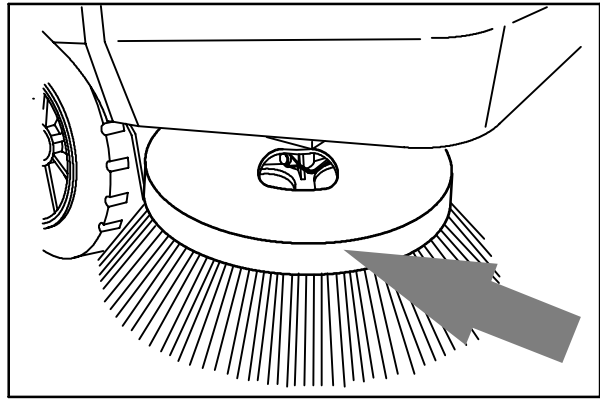

08049

### SIDE BRUSH PIVOT

The side brush pivot should be checked for excessive movement after every 200 hours of operation. Torque the front and rear compression springs to reduce excessive movement.

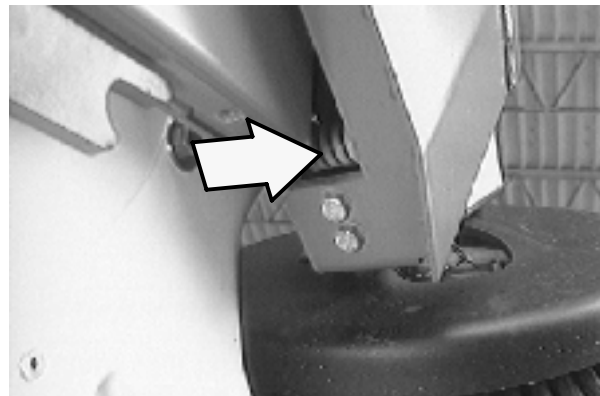
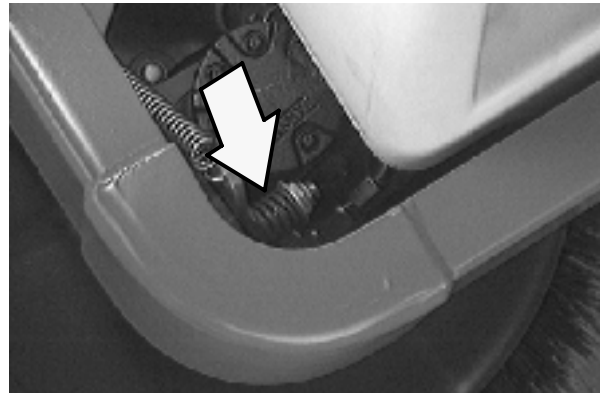

The side brush tilt is adjusted with the side brush cable. Turn the clevis on the cable to get the desired side brush pattern.

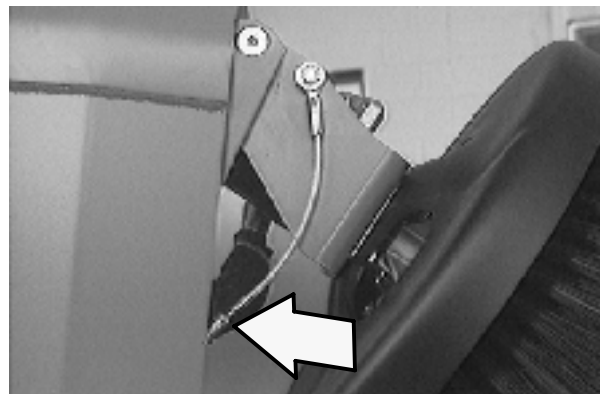



**SKIRTS AND SEALS**

**HOPPER LIP SKIRT**

The hopper lip skirt is located on the bottom rear of the hopper. The skirt floats over debris and helps deflect that debris into the hopper.

Check the hopper lip skirt for wear or damage daily.

Replace the hopper lip skirt when it no longer touches the floor.

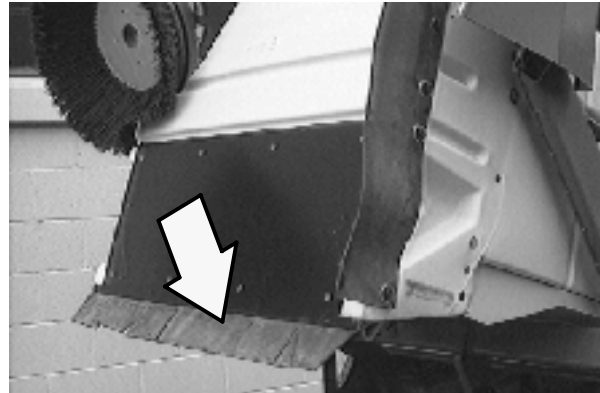

**HOPPER SIDE SKIRT**

The hopper side skirt is located on the left side of the hopper. The hopper side skirt should clear the floor by 3 mm (0.12 in).

Check the hopper side skirt for wear or damage and adjustment daily.

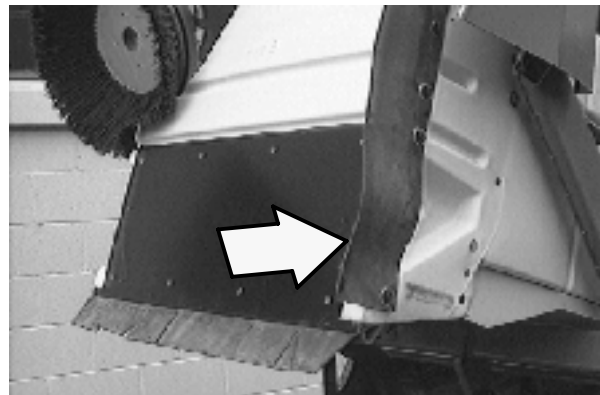

**BRUSH DOOR SKIRTS**

The brush door skirts are located on the bottom of each of the two main brush doors. The skirt should clear the floor by 3 to 6 mm (0.12 to 0.25 in).

Check the skirts for wear or damage and adjustment daily.

*NOTE: The brush door skirts have slotted holes to allow for a ground clearance adjustment. Adjust the skirt height with the door closed.*

*NOTE: Rear tire pressure will affect skirt clearances.*

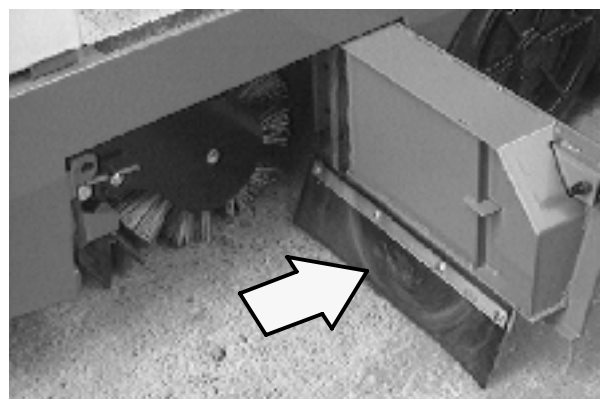

## MAINTENANCE

### REAR SKIRTS

The two rear skirts are located on the bottom rear of the main brush compartment. The vertical skirt should clear the floor up to 5 mm (0.25 in). The recirculation skirt requires no adjustment.

Check the skirts for wear or damage and adjustment daily.

*NOTE: Rear tire pressure will affect skirt clearances.*

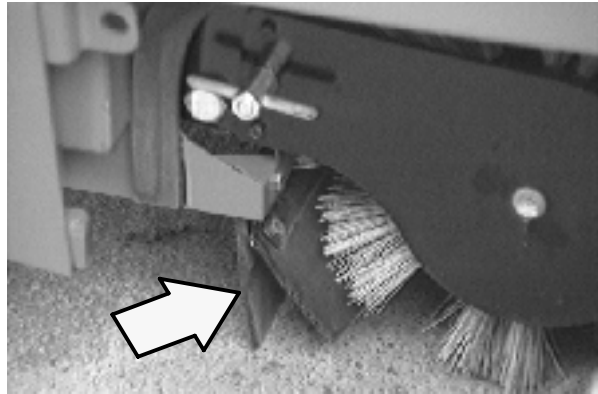

### SIDE BRUSH DUST CONTROL SKIRTS (OPTION)

The side brush dust control skirts wrap around the side brush and the front bumper.

Check the side brush dust control skirts for wear or damage daily.

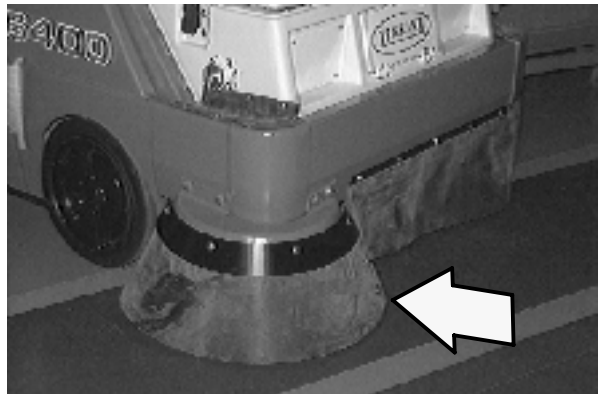

### BRUSH DOOR SEALS

The brush door seals are located on both main brush doors and on corresponding portions of the main frame.

Check the seals for wear or damage after every 100 hours of operation.

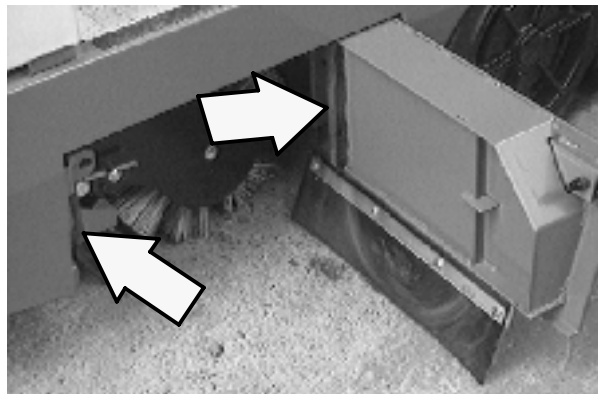

### HOPPER SEALS

The hopper seals are located on the top and side portions of the machine frame that contact the hopper.

Check the seals for wear or damage after every 100 hours of operation.



**HOPPER ACCESS DOOR SEAL**

The hopper access door seal is located on the hopper and seals the front of the debris hopper.

Check the seal for wear or damage after every 100 hours of operation.

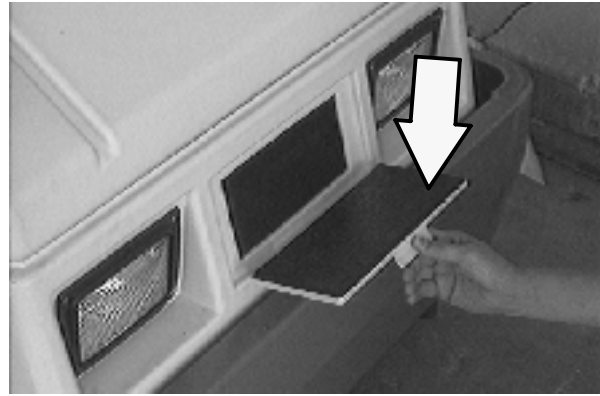
**HOPPER DOOR SEALS**

The hopper door seals are located on the hopper door. They seal the hopper when the hopper door is closed.

Check the seals for wear or damage after every 100 hours of operation.

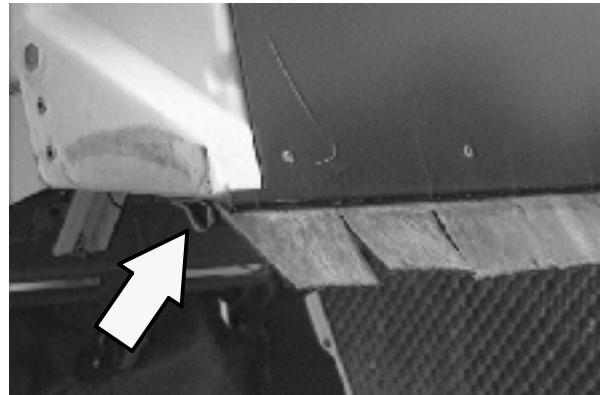
**VACUUM FAN SEAL**

The vacuum fan seal is mounted on the vacuum shut-off plate.

Check the seal for wear or damage after every 100 hours of operation.

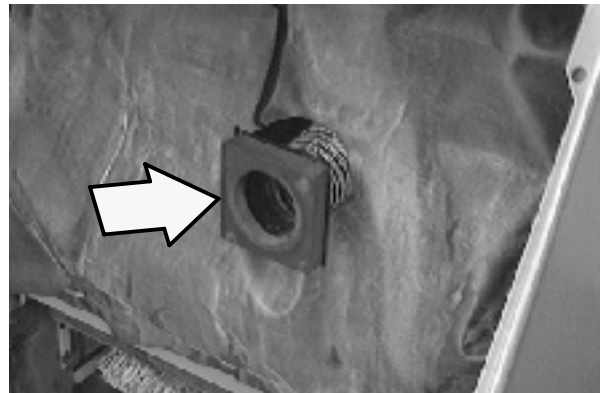

## BRAKES AND TIRES

### BRAKES

The mechanical brakes are located on the front wheels. The brakes are operated by the foot brake pedal and connecting rods.

Check the brake adjustment after every 200 hours of operation.

### TIRES

The standard front machine tires are solid. The standard rear machine tire is pneumatic.

Check the front tires after every 100 hours of operation for damage. Check the rear tire pressure after every 100 hours of operation. The proper tire pressure is 795 kPa (115 psi).



### REAR WHEEL

Torque the rear wheel nuts twice in the pattern shown to 122 to 155 Nm (90 to 110 ft lb) after the first 50 hours of operation, and every 800 hours of operation.

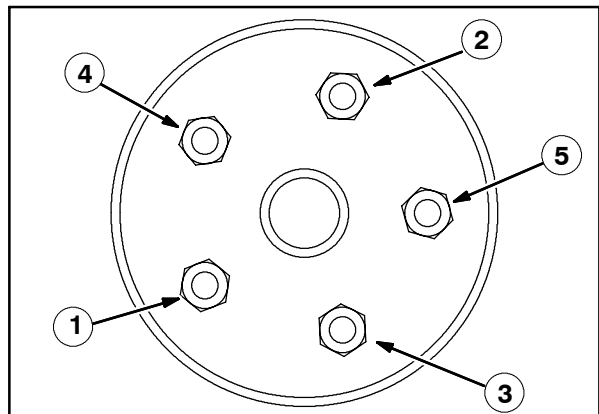

**PUSHING, TOWING, AND TRANSPORTING THE MACHINE**

**PUSHING OR TOWING THE MACHINE**

If the machine becomes disabled, it can be pushed from the front or rear, but towed only from the rear.

The propelling pump has a bypass valve to prevent damage to the hydraulic system when the machine is being pushed or towed. This valve allows a disabled machine to be moved for a *very short distance* and at a speed to not exceed 1.6 kp/h (1 mph). The machine is NOT intended to be pushed or towed a long distance or at a high speed.

**ATTENTION! Do not push or tow machine for a long distance and without using the bypass valve, or the machine hydraulic system may be damaged.**

Turn the bypass valve 90° from the normal position before pushing or towing the machine. **The illustration shows the bypass valve in the pushing or towing position.**

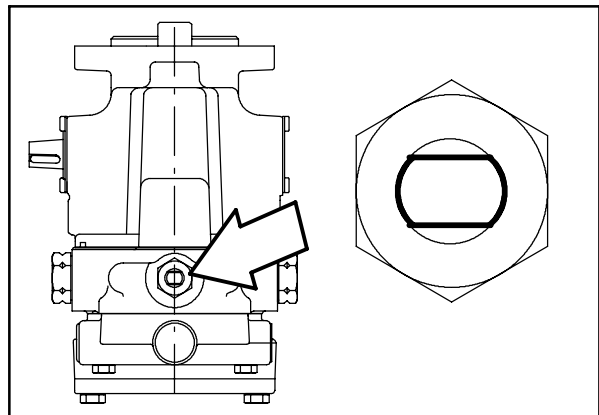
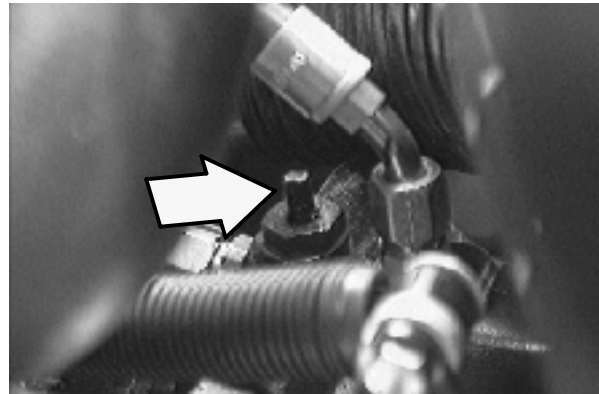

## TRANSPORTING THE MACHINE

1. Position the rear of the machine at the loading edge of the truck or trailer.

**FOR SAFETY: Use truck or trailer that will support the weight of the machine.**

*NOTE: Empty the hopper before transporting the machine.*

2. If the loading surface is not horizontal or is higher than 380 mm (15 in) from the ground, use a winch to load machine.

If the loading surface is horizontal AND is 380 mm (15 in) or less from the ground, the machine may be driven onto the truck or trailer.

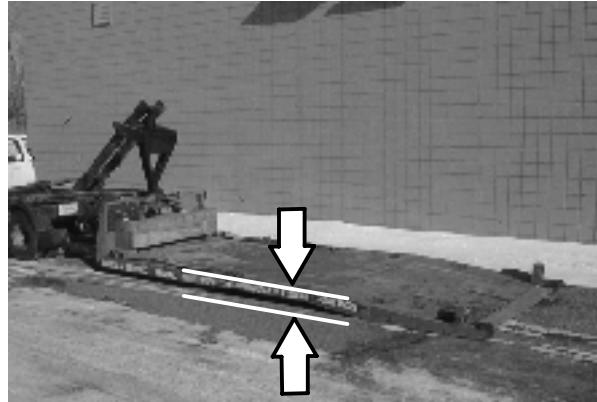

3. To winch the machine onto the truck or trailer, attach the winching chains to the rear tie-down locations. The rear tie-down locations are the holes in the sides of the machine frame near the rear bumper.

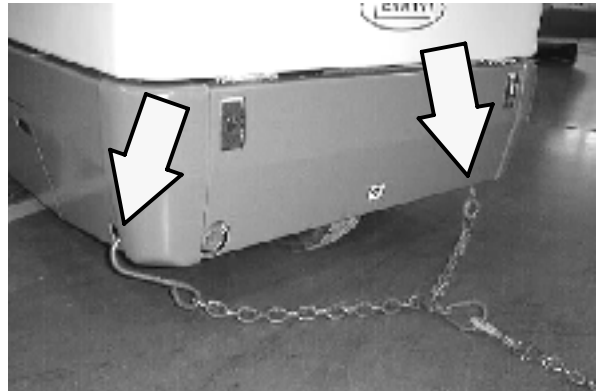

4. Turn the bypass valve 90° from the normal position before winching the machine onto the truck or trailer. See *PUSHING OR TOWING THE MACHINE* section of this manual. Make sure the machine is centered.

**FOR SAFETY: When loading machine onto truck or trailer, use winch. Do not drive the machine onto the truck or trailer unless the loading surface is horizontal AND is 380 mm (15 in) or less from the ground.**

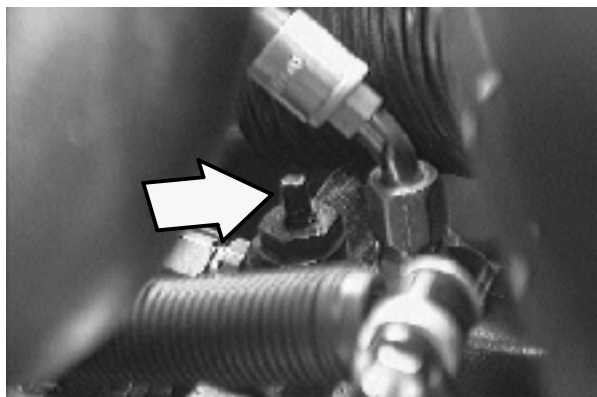

5. Position the machine onto the truck or trailer as far as possible. If the machine starts to veer off the centerline of the truck or trailer, stop and turn the steering wheel to center the machine.
6. Set the parking brake and block the machine tires. Tie down the machine to the truck or trailer before transporting.

The front tie-down locations are the holes in the wheel pockets at the front of the machine frame.



The rear tie-down locations are the holes in the sides of the machine frame near the rear bumper.



7. If the loading surface is not horizontal or is higher than 380 mm (15 in) from the ground, use a winch to unload machine.

If the loading surface is horizontal AND is 380 mm (15 in) or less from the ground, the machine may be driven off the truck or trailer.

**FOR SAFETY: When unloading machine off truck or trailer, use winch. Do not drive the machine off the truck or trailer unless the loading surface is horizontal AND 380 mm (15 in) or less from the ground.**

## MAINTENANCE

---

### MACHINE JACKING

---

Empty the hopper before jacking the machine. The machine can be raised for service at the designated locations. Use a hoist or jack that will support the weight of the machine. Always stop the machine on a flat, level surface and block the tires before jacking up the machine.

**FOR SAFETY: Before leaving or servicing machine, stop on level surface, set parking brake, turn off machine, and remove key.**

The front jacking locations are on the flat bottom edge of the front of the machine frame next to the front tires.



The rear jacking location is the center of the rear bumper.

**FOR SAFETY: When servicing machine, block machine tires before jacking up machine.**

**FOR SAFETY: When servicing machine, jack up machine at designated locations only. Block machine up with jack stands.**



---

### STORING MACHINE

---

Before storing the machine for an extended time, the machine needs to be serviced to lessen the chance of rust, sludge, and other undesirable deposits from forming.



**SPECIFICATIONS**

**GENERAL MACHINE DIMENSIONS/CAPACITIES**

Item	Dimension/capacity	
Length	2085 mm	(82 in)
Length with side brush	2260 mm	(89 in)
Width	1230 mm	(48.4 in)
Width with side brush	1395 mm	(55 in)
Height	1435 mm	(56.5 in)
Height with overhead guard	2085 mm	(82 in)
Track	1135 mm	(44.7 in)
Wheelbase	1135 mm	(44.7 in)
Main sweeping brush diameter	355 mm	(14 in)
Main sweeping brush length	915 mm	(36 in)
Side brush diameter	585 mm	(23 in)
Sweeping path width	915 mm	(36 in)
Sweeping path width with side brush	1270 mm	(50 in)
Main sweeping brush pattern width	50 to 75 mm	(2 to 3 in)
Hopper weight capacity	315 kg	(700 lb)
Hopper volume capacity	315 L	(11.25 ft <sup>3</sup> )
Dust filter area	6.9 m <sup>2</sup>	(74 ft <sup>2</sup> )
GVWR	1542 kg	(3400 lb)
Ceiling height minimum dumping clearance	2340 mm	(92 in)

**GENERAL MACHINE PERFORMANCE**

Item	Measure	
Maximum forward speed	9.6 km/h	(6 mph)
Maximum reverse speed	4.8 km/h	(3 mph)
Minimum aisle turn width, left	2360 mm	(93 in)
Minimum turning radius, right	1490 mm	(58.7 in)
Minimum turning radius, left	1135 mm	(44.7 in)
Maximum rated incline with empty hopper	10° / 17.6%	
Maximum rated incline with full hopper	8° / 14.1%	

## SPECIFICATIONS

### POWER TYPE

Engine	Type	Ignition	Cycle	Aspiration	Cylinders	Bore	Stroke
Kubota D905	Piston	Diesel	4	Natural	3	72 mm (2.83 in)	73.6 mm (2.90 in)
	Displacement		Net power, governed		Net power, maximum		
	898 cc (54.86 cu in)		13 kw (17.5 hp) @ 2500 rpm		19.4 kw (26 hp) @ 3600 rpm		
	Fuel		Cooling system		Electrical system		
	Diesel Fuel tank: 27.6 L (7.3 gal)		Water/ethylene glycol antifreeze		12 V nominal		
			Radiator: 4 L (1 gal) Total: 8 L (2 gal)		30 A alternator		
	Idle speed		(Fast) governed speed under load		Engine lubricating oil with filter		
1400 ± 50 rpm		2450 ± 50 rpm		5.1 L (5.4 qt) 10W30 SAE-CD/CE			

### STEERING

Type	Power source	Emergency steering
Rear wheel, hydraulic cylinder and rotary valve controlled	Hydraulic accessory pump	Manual

### HYDRAULIC SYSTEM

System	Capacity	Fluid Type
Hydraulic reservoir	19.3 L (5.1 gal)	TENNANT part no. 65869 - above 7° C (45° F)
Hydraulic total	20.8 L (5.5 gal)	TENNANT part no. 65870 - below 7° C (45° F)

### BRAKING SYSTEM

Type	Operation
Service brakes	Mechanical drum brakes (2), one per front wheel, rod actuated
Parking brake	Utilize service brakes, rod actuated

### TIRES

Location	Type	Size	Pressure
Front (2)	Solid	406 x 89 x 308 (16 x 3 1/2 x 12 1/8)	-
Rear (1)	Pneumatic	150/75 R8 10P (16 x 68)	795 kPa (115 psi)

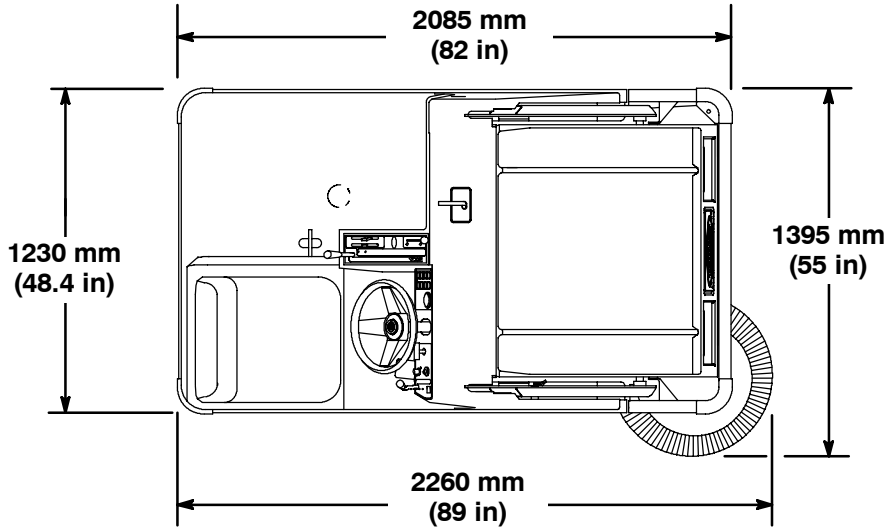

**TOP VIEW**

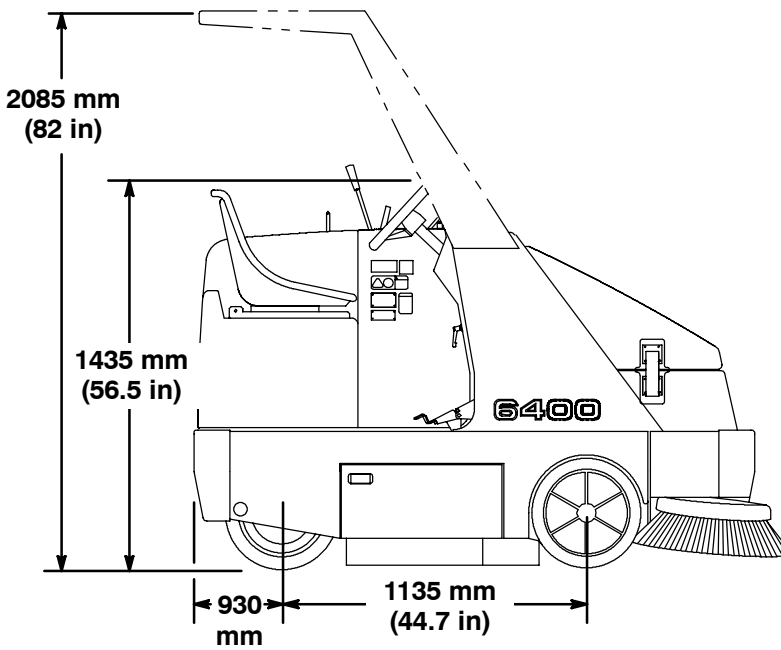

**SIDE VIEW**

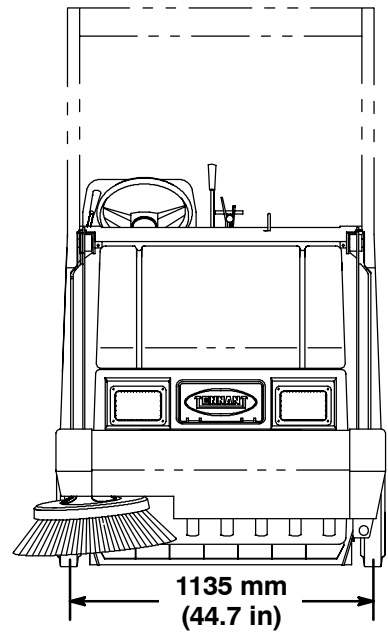

**FRONT VIEW**

**MACHINE DIMENSIONS**

350158-350165

**INDEX****A**

Air filter, 51  
  Cleaning, 51–53  
  Dust cap, 51  
  Element, 51  
Air filter indicator, 50  
Aisle turn, 71

**B**

Battery, 54  
  Charging system, Light, 15  
Bearings  
  Front wheel, 47  
  Rear wheel support, 46  
Belts, 55  
  Engine, 55  
  Vacuum Fan, 55  
Brake pedal, 12  
Brakes, 24, 35, 66  
  System specifications, 72  
Brush door seals, 64  
Brush door skirts, 63  
Brushes, 27–30, 58–63  
  Adjusting main brush taper, 60  
  Checking main brush pattern, 59–61  
  Checking side brush pattern, 61  
  Door seals, 64  
  Door skirts, 63  
  Main brush, 27, 58–61  
  Main brush bristle length, 58  
  Main brush down pressure knob, 14  
  Main brush lever, 14  
  Maintenance, 24, 35  
  Pattern adjustment, 24, 35  
  Rear skirts, 64  
  Replacing main brush, 58–60  
  Replacing side brush, 61  
  Side brush, 28, 61–63  
  Side brush bristle length, 61  
  Side brush down pressure knob, 21  
  Side brush dust control skirts, 64  
  Side brush guard, 62  
  Side brush lever, 20  
  Side brush pivot, 62

Buttons, Horn, 19  
Bypass valve, 67

**C**

Capacities, 71  
Chains, 55  
  Static drag, 55  
Charging system light, 15  
Circuit breakers, 21  
Clogged filter light, 17  
Control panel  
  Clogged filter light, 17  
  Engine oil pressure, 15  
  Engine water temperature light, 15  
  Fuel level gauge, 18  
  Glow plug light, 16  
  Hopper door closed light, 17  
  Hopper temperature light, 16  
  Hourmeter, 18  
  Hydraulic filter bypass light, 18  
  Operating lights switch, 20  
  Operating/hazard lights switch, 20  
Controls, 10  
  Brake pedal, 12  
  Charging system light, 15  
  Circuit breakers, 21  
  Clogged filter light, 17  
  Directional pedal, 11  
  Engine oil pressure light, 15  
  Engine water temperature light, 15  
  Fuel level gauge, 18  
  Fuse, 21  
  Glow plug light, 16  
  Hopper door closed light, 17  
  Hopper door lever, 13  
  Hopper lever, 13  
  Hopper temperature light, 16  
  Horn button, 19  
  Hourmeter, 18  
  Hydraulic filter bypass light, 18  
  Ignition switch, 19  
  Main brush down pressure knob, 14  
  Main brush lever, 14  
  Operating lights switch, 20  
  Operating/hazard lights switch, 20  
  Operation, 11  
  Parking brake pedal, 12  
  Seat support release lever, 12  
  Side brush down pressure knob, 21  
  Side brush lever, 20

Steering wheel, 18  
 Steering wheel tilt handle, 19  
 Symbols, 8–10  
 Throttle lever, 13  
 Vacuum and filter shaker lever, 14  
 Cooling system, 50

**D**

Debris hopper, 56–58  
 Deluxe suspension seat, 22  
 Dimensions, 71  
 Directional pedal, 11  
 Disengaging hopper support bar, 38–40  
 Doors  
   Brush  
     Seals, 64  
     Skirts, 63  
   Hopper, Seals, 65  
   Hopper access, Seal, 65  
 Dust filter, 56–58  
   Changing, 57–59  
   Cleaning, 56

**E**

Electrical, 54  
   Battery, 54  
   Circuit breakers, 21  
   Fuse, 21  
   Ignition switch, 19  
 Emptying the hopper, 31–33  
 Engaging hopper support bar, 36–38  
 Engine, 50–53  
   Air filter, 24, 35, 51  
     Cleaning, 51–53  
   Air filter indicator, 50  
   Belt, 55  
   Coolant level, 24, 35  
   Coolant temperature, Light, 15  
   Cooling system, 50  
   Fuel filters, 52  
   Fuel level, 24, 35  
   Fuel lines, 52  
   Lubrication, 46  
   Oil capacity, 46  
   Oil level, 24, 35  
   Oil pressure, Light, 15  
   Priming fuel system, 53  
   Specifications, 72

Valve clearance, 53  
 Engine belt, 55  
 Engine oil pressure light, 15  
 Engine water temperature light, 15

**F**

Front wheel, Bearings, 47  
 Front wheel bearings, 47  
 Fuel filters, 52  
 Fuel level gauge, 18  
 Fuel lines, 52  
 Fuel system  
   Fuel lines, 52  
   Priming, 53  
 Fuses, 21

**G**

Gauges, Fuel level, 18  
 Glow plug light, 16  
 Grease fittings  
   Hopper lift arm pivots, 47  
   Rear wheel support, 46  
   Steering cylinder, 46

**H**

Hopper  
   Access door seal, 65  
   Changing dust filter, 57–59  
   Cleaning dust filter, 56  
   Clogged filter, Light, 17  
   Debris, 56–58  
   Disengaging hopper support bar, 38–40  
   Door closed, Light, 17  
   Door lever, 13  
   Door seals, 65  
   Dust filter, 56–58  
   Emptying the hopper, 31–33  
   Engaging hopper support bar, 36–38  
   Lever, 13  
   Lift arm pivots, 47  
   Lip skirt, 63  
   Seals, 64  
   Side skirt, 63  
   Support bar, 23  
   Temperature, Light, 16  
   Thermo Sentry, 14, 16  
   Vacuum fan seal, 65

Hopper access door seal, 65  
Hopper door closed light, 17  
Hopper door lever, 13  
Hopper door seals, 65  
Hopper lever, 13  
Hopper lift arm pivots, 47  
Hopper lip skirt, 63  
Hopper seals, 64  
Hopper side skirt, 63  
Hopper support bar, 23  
Hopper temperature light, 16  
Horn button, 19  
Hourmeter, 18  
How the machine works, 24  
Hydraulic cooler, Fins, 24, 35  
Hydraulic filter bypass light, 18  
Hydraulic fluid, 48  
Hydraulic fluid reservoir, 48  
Hydraulic hoses, 49  
Hydraulics, 48–50  
    Filter bypass light, 18  
    Fluid, 48–50  
    Fluid filter, 48  
    Fluid level, 24, 35, 48  
    Hoses, 49  
    Propelling motor, 49  
    Reservoir, 48  
    System specifications, 72

**I**

Ignition, Glow plug, Light, 16  
Ignition switch, 19

**J**

Jack points, 70  
Jacking up the machine, 70

**K**

Knobs  
    Main brush down pressure, 14  
    Side brush down pressure, 21

**L**

Levers  
    Hopper, 13  
    Hopper door, 13  
    Main brush, 14  
    Seat support release, 12  
    Side brush, 20  
    Steering wheel tilt handle, 19  
    Throttle, 13  
    Vacuum and filter shaker, 14  
Lights  
    Charging system, 15  
    Clogged filter, 17  
    Engine oil pressure, 15  
    Engine water temperature, 15  
    Glow plug, 16  
    Hopper door closed, 17  
    Hopper temperature, 16  
    Hydraulic filter bypass, 18  
    Operating lights switch, 20  
    Operating/hazard lights switch, 20  
Lubrication, 46–48  
    Engine, 46

**M**

Machine components, 7  
Machine dimensions, 73  
Machine jacking, 70  
Machine tie down location, 69  
Main brush, 27, 58–61  
    Adjust brush taper, 60  
    Bristle length, 58  
    Checking brush pattern, 59–61  
    Door seals, 64  
    Door skirts, 63  
    Down pressure, 14  
    Lever, 14  
    Maintenance, 58  
    Rear skirts, 64  
    Replacing, 58–60  
Main brush down pressure knob, 14  
Main brush lever, 14  
Maintenance, 44  
    Intervals, 44–46  
    Recommended, 6

Maintenance chart, 44–46

Motors, Propelling, 49

## O

Operating lights switch, 20

Operating/hazard lights switch, 20

Operation, 6

Operation on inclines, 39

Operator Responsibility, 6

Operator seat, 22

Options, 40–42

Air filter indicator, 50

Clogged filter light, 17

Hopper door closed light, 17

Hydraulic filter bypass light, 18

Operating/hazard lights switch, 20

Side brush dust control skirts, 64

Vacuum Wand, 40

## P

Parking brake pedal, 12

Pedals

Brake, 12

Directional, 11

Parking brake, 12

Pivots

Hopper lift arm, 47

Side brush, 62

Post-operation checklist, 35

Pre-operation checklist, 24–26

Priming fuel system, 53

Propelling motor, 49

Pushing machine, 67

Pushing or towing the machine, 67

Pushing, towing, and transporting machine, 67

## R

Radiator, 50

Coolant level, 50

Coolant type, 50

Fins, 24, 35

Flushing system, 50

Hoses, 50

Rear skirts, 64

Rear wheel, 66

Steering cylinder, 46

Support, 46

Rear wheel support, 46

Bearings, 46

Grease fitting, 46

## S

Safety

Disengaging hopper support bar, 38–40

Engaging hopper support bar, 36–38

Hopper support bar, 23

Labels, 5

Precautions, 3–5

Seals, 63–66

Brush doors, 64

Hopper, 64

Hopper access door, 65

Hopper door, 65

Vacuum fan, 65

Seat

Adjustment, 22

Deluxe suspension, 22

Operator, 22

Seat support, Release lever, 12

Seat support release lever, 12

Service records, 24, 35

Side brush, 28, 61–63

Bristle length, 61

Checking brush pattern, 61

Down pressure, 21

Dust control skirts, 64

Guard, 62

Lever, 20

Pivot, 62

Replacing, 61

Side brush down pressure knob, 21

Side brush dust control skirts, 64

Side brush guard, 62

Side brush lever, 20

Side brush pivot, 62

Skirts, 63–66

Brush doors, 63

Hopper Lip, 63

Hopper side, 63

Rear, 64

Side brush dust control, 64

Skirts and seals, 24, 35

Specifications, 71–74

Braking system, 72

Hydraulic system, 72

Machine capacities, 71

Machine dimensions, 71

Machine performance, 71

Power type, 72

Steering, 72

Tires, 72

Starting the machine, 25–27

Static drag chain, 55

Steering, 24, 35

Specifications, 72

Steering cylinder, 46

Grease fitting, 46

Steering wheel, 18

Steering wheel tilt handle, 19

Stop sweeping, 30

Stop the machine, 33–35

Storing machine, 70

Sweeping, 28–30

Sweeping and brush information, 27–30

Switches

Ignition, 19

Operating lights, 20

Operating/hazard lights, 20

## **T**

Thermo Sentry, 14, 16

Throttle lever, 13

Tie down location, 69

Tires, 66

Rear wheel, 66

Specifications, 72

Towing machine, 67

Transporting machine, 67

Transporting the machine, 68

Travel speed, 71

Troubleshooting, 42

## **V**

Vacuum and filter shaker lever, 14

Vacuum fan

Belt, 55

Seal, 65

Vacuum fan belt, 55

Vacuum fan seal, 65

Vacuum Wand, 40

Valve clearance, 53

Valves, 53

## **W**

Wheel nuts, Torque, 66