

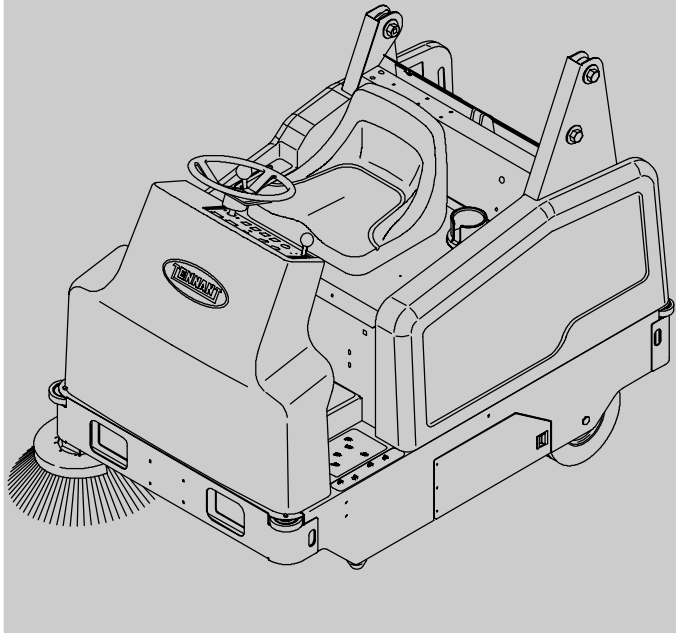

6200

(Gas/LPG)

Sweeper Operator Manual



North America / International

www.tennantco.com

330370
Rev. 11 (2-2010)





This manual is furnished with each new model. It provides necessary operation and maintenance instructions.

Read this manual completely and understand the machine before operating or servicing it.

This machine will provide excellent service. However, the best results will be obtained at minimum costs if:

- The machine is operated with reasonable care.
- The machine is maintained regularly - per the machine maintenance instructions provided.
- The machine is maintained with manufacturer supplied or equivalent parts.

	PROTECT THE ENVIRONMENT Please dispose of packaging materials, old machine components including batteries, hazardous fluids such as antifreeze and oil, in an environmentally safe way according to local waste disposal regulations. Always remember to recycle.
	

MACHINE DATA	
Please fill out at time of installation for future reference.	
Model No. -	_____
Serial No. -	_____
Machine Options -	_____
Sales Rep. -	_____
Sales Rep. phone no. -	_____
Customer Number -	_____
Installation Date -	_____

Tennant Company
PO Box 1452
Minneapolis, MN 55440
Phone: (800) 553-8033 or (763) 513-2850
www.tennantco.com

 **CALIFORNIA PROPOSITION 65 WARNING:**
Engine exhaust from this product contains chemicals known to the State of California to cause cancer, birth defects, or other reproductive harm.

Quick Mop, VCS, Instant Access filter, and Thermo Sentry are US registered and unregistered trademarks of Tennant Company.

Specifications and parts are subject to change without notice.

Original Instructions, Copyright © 1999-2003, 2005-2008, 2010 TENNANT, Printed in U.S.A.

CONTENTS

	Page		Page
SAFETY PRECAUTIONS	3	MAINTENANCE	40
OPERATION	5	MAINTENANCE CHART	40
OPERATOR RESPONSIBILITY	5	LUBRICATION	42
MACHINE COMPONENTS	6	ENGINE	42
SYMBOL DEFINITIONS	7	STEERING GEAR CHAIN	42
CONTROLS AND INSTRUMENTS	8	STEERING CASTOR PIVOT BEARING	43
OPERATION OF CONTROLS	9	HYDRAULICS	44
DIRECTIONAL PEDAL	9	HYDRAULIC FLUID RESERVOIRS ...	44
BRAKE PEDAL	10	HYDRAULIC FLUID	46
PARKING BRAKE PEDAL	10	HYDRAULIC HOSES	47
LARGE DEBRIS TRAP PEDAL	10	ENGINE	47
IGNITION SWITCH	11	AIR FILTER	47
HORN BUTTON	11	FUEL LINES	48
SIDE BRUSH LEVER	11	CARBURETOR	49
OPERATING LIGHTS SWITCH		SPARK PLUGS	49
(OPTION)	12	BATTERY	49
OPERATING/HAZARD LIGHTS		BELTS AND CHAINS	50
SWITCH (OPTION)	12	VACUUM FAN BELT	50
MAIN BRUSH LEVER	13	MAIN BRUSH BELT	50
CHARGING SYSTEM LIGHT	13	HYDRAULIC PUMP BELT	51
LOW OIL WARNING INDICATOR	13	JACKSHAFT BELT	51
FUEL LEVEL GAUGE	14	STEERING GEAR CHAIN	52
GASOLINE ENGINE CHOKE KNOB ..	14	STATIC DRAG CHAIN	52
VACUUM FAN/FILTER SHAKER		DEBRIS HOPPER	53
SWITCH	15	HOPPER DUST FILTER	53
STEERING WHEEL	15	REMOVING HOPPER DUST FILTER .	54
HOURMETER	15	THERMO SENTRY	57
HOPPER SWITCH	16	BRUSHES	58
HOPPER DOOR SWITCH	16	MAIN BRUSH	58
CIRCUIT BREAKERS	17	REPLACING MAIN BRUSH	58
OPERATOR SEAT	18	CHECKING AND ADJUSTING	
ADJUSTABLE OPERATOR SEAT		MAIN BRUSH PATTERN	59
(OPTION)	18	SIDE BRUSH	61
DELUXE SUSPENSION SEAT		REPLACING SIDE BRUSH	62
(OPTION)	18	SIDE BRUSH GUARD	62
HOPPER SUPPORT BAR	19	SKIRTS AND SEALS	63
HOW THE MACHINE WORKS	20	SIDE SKIRTS	63
PRE-OPERATION CHECKLIST	20	LARGE DEBRIS TRAP SKIRT	63
CHANGING AN LPG FUEL TANK	21	SIDE RECIRCULATION SKIRTS	63
STARTING THE MACHINE	23	REAR SKIRTS	64
OPERATION ON INCLINES	24	HOPPER SEALS	65
SWEEPING AND BRUSH INFORMATION		HOPPER DOOR SEAL	65
SWEEPING	26	HOPPER LIP SEAL	65
STOP SWEEPING	28	VACUUM SEAL	66
EMPTYING THE HOPPER	29	HOPPER FILTER SEALS	66
STOPPING THE MACHINE	31	AIR INTAKE SEAL	66
POST-OPERATION CHECKLIST	32	BRAKES AND TIRES	67
ENGAGING HOPPER SUPPORT BAR ..	33	BRAKES	67
DISENGAGING HOPPER SUPPORT BAR		TIRES	68
OPTIONS	37	PUSHING, TOWING, AND TRANSPORTING	
QUICK MOP	37	THE MACHINE	69
MACHINE TROUBLESHOOTING	39	PUSHING OR TOWING THE MACHINE	69
		TRANSPORTING THE MACHINE	69
		MACHINE JACKING	71
		STORING MACHINE	71

CONTENTS

	Page
SPECIFICATIONS	72
GENERAL MACHINE PERFORMANCE ..	72
POWER TYPE	73
STEERING	73
HYDRAULIC SYSTEMS	73
BRAKING SYSTEM	73
TIRES	73
MACHINE DIMENSIONS	74
INDEX	75

SAFETY PRECAUTIONS

The following symbols are used throughout this manual as indicated in their description:



WARNING: To warn of hazards or unsafe practices that could result in severe personal injury or death.

FOR SAFETY: To identify actions that must be followed for safe operation of equipment.

The machine is suited to sweep disposable debris. Do not use the machine other than described in this Operator Manual. The machine is not designed for use on public roads.

The following information signals potentially dangerous conditions to the operator or equipment:



WARNING: Engine emits toxic gases. Severe respiratory damage or asphyxiation can result. Provide adequate ventilation. Consult with your regulatory authorities for exposure limits. Keep engine properly tuned.



WARNING: Lift arm pinch point. Stay clear of hopper lift arms.



WARNING: Raised hopper may fall. Engage hopper support bar.

FOR SAFETY:

1. **Do not operate machine:**
 - Unless trained and authorized.
 - Unless operation manual is read and understood.
 - In flammable or explosive areas unless designed for use in those areas.
 - In areas with possible falling objects unless equipped with overhead guard.
2. **Before starting machine:**
 - Check for fuel leaks.
 - Keep sparks and open flame away from refueling area.
 - Make sure all safety devices are in place and operate properly.
 - Check brakes and steering for proper operation.
3. **When starting machine:**
 - Keep foot on brake and directional pedal in neutral.

4. **When using machine:**
 - Do not pickup up burning or smoking debris, such as cigarettes, matches or hot ashes.
 - Use brakes to stop machine.
 - Go slowly on inclines and slippery surfaces.
 - Use care when reversing machine.
 - Do not carry riders on machine.
 - Always follow safety and traffic rules.
 - Report machine damage or faulty operation immediately.
5. **Before leaving or servicing machine:**
 - Stop on level surface.
 - Set parking brake.
 - Turn off machine and remove key.
6. **When servicing machine:**
 - Avoid moving parts. Do not wear loose jackets, shirts, or sleeves when working on machine.
 - Block machine tires before jacking up machine.
 - Jack up machine at designated locations only. Block machine up with jack stands.
 - Use hoist or jack that will support the weight of the machine.
 - Wear eye and ear protection if using pressurized air or water.
 - Disconnect battery connections before working on machine.
 - Avoid contact with battery acid.
 - Use cardboard to locate leaking hydraulic fluid under pressure.
 - Use Tennant supplied or equivalent replacement parts.
7. **When loading/unloading machine onto/off truck or trailer:**
 - Turn off machine.
 - Use truck or trailer that will support the weight of the machine.
 - Use winch. Do not drive the machine onto/off the truck or trailer unless the load height is 380 mm (15 in) or less from the ground.
 - Set parking brake after machine is loaded.
 - Block machine tires.
 - Tie machine down to truck or trailer.

SAFETY PRECAUTIONS

The following safety labels are mounted on the machine in the locations indicated. If these or any labels become damaged or illegible, install a new label in its place.

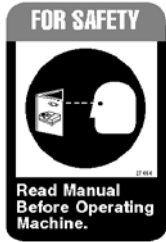

FOR SAFETY LABEL - LOCATED ON THE SIDE OF THE OPERATOR COMPARTMENT.

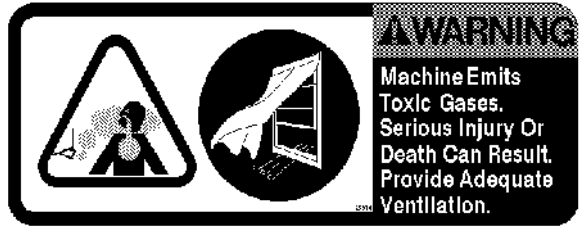

EMISSIONS LABEL - LOCATED BEHIND THE OPERATOR'S SEAT.

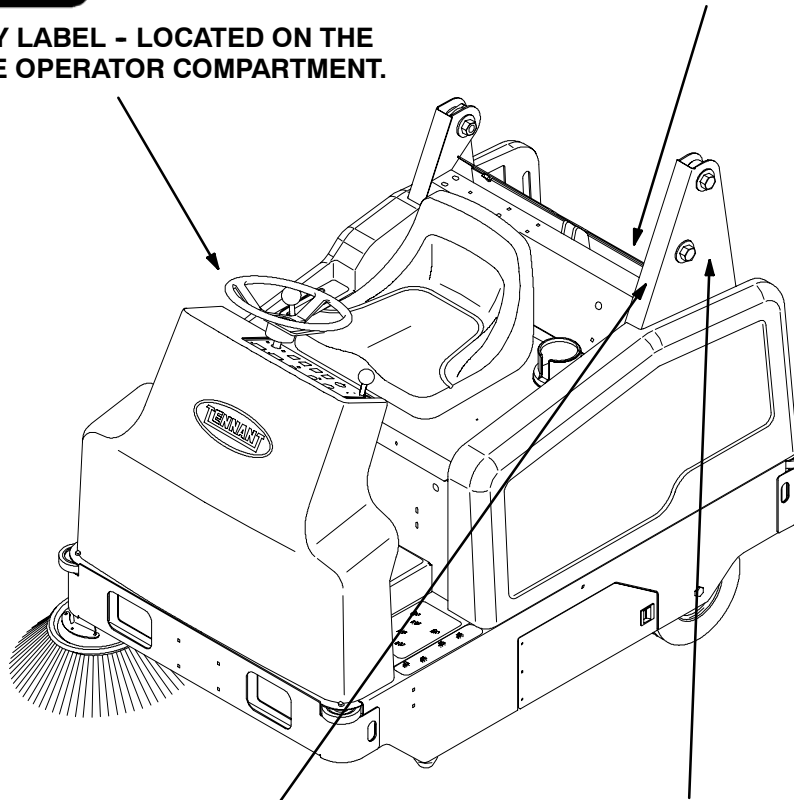

HOPPER LIFT ARMS LABEL - LOCATED ON BOTH LIFT ARMS.



HOPPER SUPPORT LABEL - LOCATED ON LEFT SIDE HOPPER LIFT ARM AND BOTH SIDES OF THE HOPPER COMPARTMENT.

OPERATION

OPERATOR RESPONSIBILITY

- The operator's responsibility is to take care of the daily maintenance and checkups of the machine to keep it in good working condition. The operator must inform the service mechanic or supervisor when the maintenance intervals are required as stated in the *MAINTENANCE* section of this manual.
- Read this manual carefully before operating the machine. View the operation video supplied with the machine.

FOR SAFETY: Do not operate machine, unless operation manual is read and understood.

- Check the machine for shipping damage. Check to make sure the machine is complete per shipping instructions.
- Keep your machine regularly maintained by following the maintenance information in this manual. We recommend taking advantage of a regularly scheduled service contract from your Tennant representative.
- Order parts and supplies directly from your authorized Tennant representative. Use the parts manual provided when ordering parts.
- After operation, follow the recommended daily and hourly procedures stated in the *MAINTENANCE CHART*.

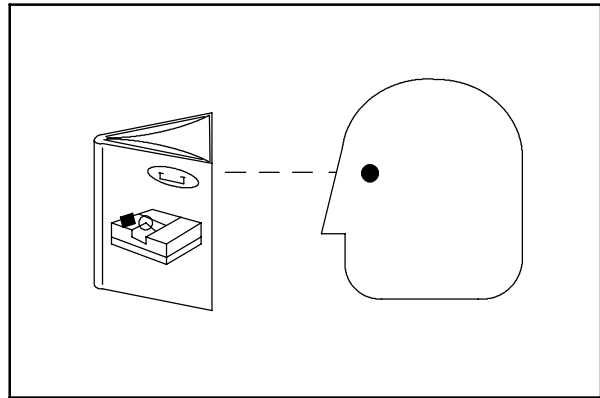

07324

OPERATION



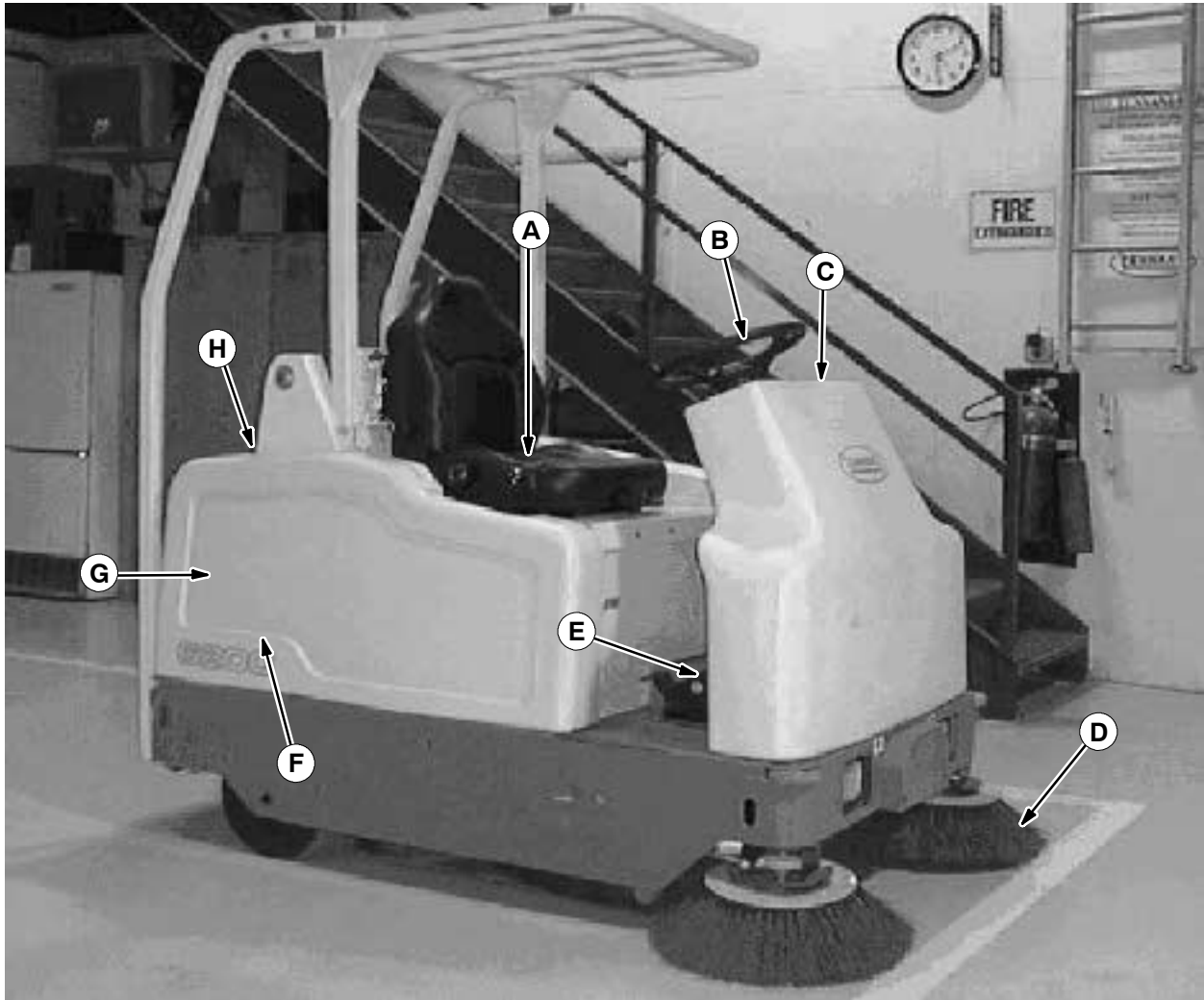

























MACHINE COMPONENTS



- A. Operator seat
- B. Steering wheel
- C. Instrument panel
- D. Side brush
- E. Control pedals
- F. Hopper
- G. Hopper filter
- H. Fuel tank

SYMBOL DEFINITIONS

These symbols identify controls, displays, and features on the machine:

	On		Voltmeter
	Off		Filter shaker
	Start		Operating lights
	Vacuum Fan		Hazard light
	Circuit breaker #1		Hopper lift
	Circuit breaker #2		Hopper lower
	Circuit breaker #3		Open hopper
	Circuit breaker #4		Close hopper
	Circuit breaker #5		Main brush down
	Circuit breaker #6		Main brush up
	Circuit breaker #7		Side brush down and on
	Circuit breaker #8		Side brush up and off
	Circuit breaker #9		Horn
	Choke		Unleaded fuel only

OPERATION

CONTROLS AND INSTRUMENTS

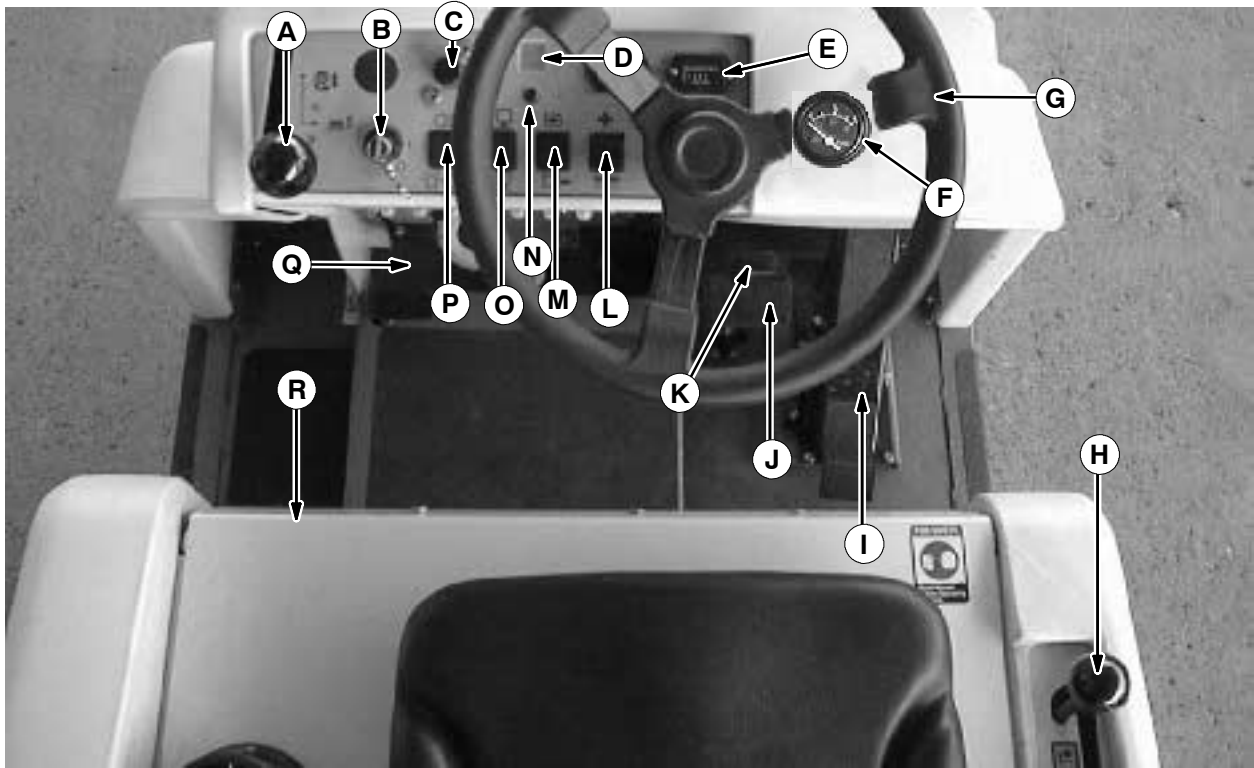

- A. Side brush lever
- B. Ignition switch
- C. Horn
- D. Charging system light
- E. Hourmeter
- F. Fuel level gauge
- G. Steering wheel
- H. Main brush lever
- I. Directional pedal
- J. Brake pedal
- K. Parking brake pedal
- L. Vacuum fan/filter shaker switch
- M. Hopper door switch
- N. Low oil warning indicator
- O. Hopper switch
- P. Operating/Hazard lights switch (option)
- Q. Large debris trap pedal
- R. Engine choke knob

OPERATION OF CONTROLS

DIRECTIONAL PEDAL

The *directional pedal* controls the direction of travel and the propelling speed of the machine. Change the speed of the machine with the pressure of your foot on the pedal; the harder you press the faster the machine travels.

Use the brake pedal to stop the machine.

Forward: Press the top of the directional pedal with the toe of your foot.

Note: The machine will not travel unless the operator is sitting in the operator's seat.

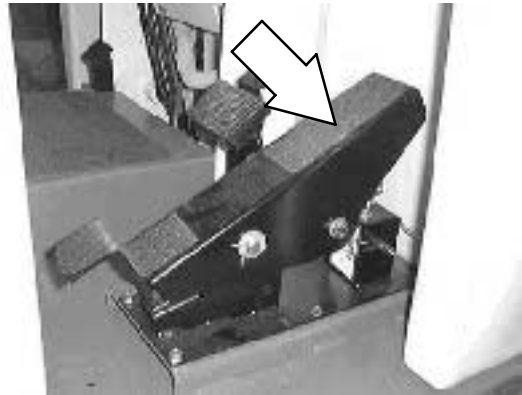

Reverse: Press the bottom of the directional pedal with the heel of your foot.

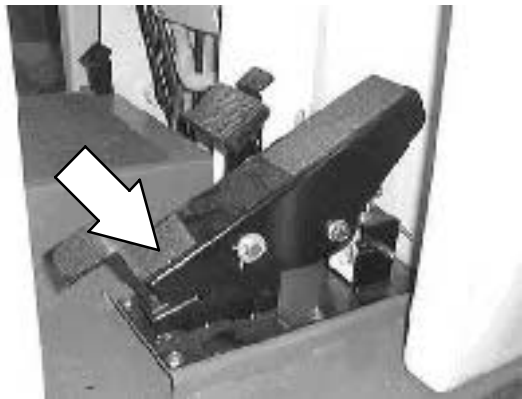

Neutral: Take your foot off the directional pedal and it will return to the **Neutral** position.



OPERATION

BRAKE PEDAL

The *brake pedal* stops the machine.

Stop: Remove your foot from the directional pedal and let it return to the **Neutral** position. Step on the brake pedal to prevent the machine from rolling.

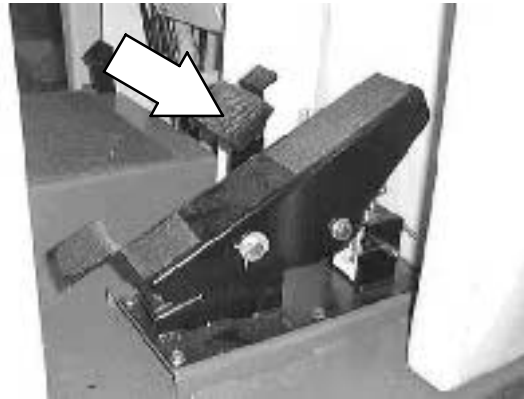

PARKING BRAKE PEDAL

The *parking brake pedal* sets and releases the front wheel brake.

Set: Hold the brake pedal with the right foot. Press on the parking brake pedal with the left foot to lock the parking brake pedal in place.

FOR SAFETY: Before leaving or servicing machine, stop on level surface, set parking brake, turn off machine, and remove key.

Release: Press down on the brake pedal until the parking brake releases.

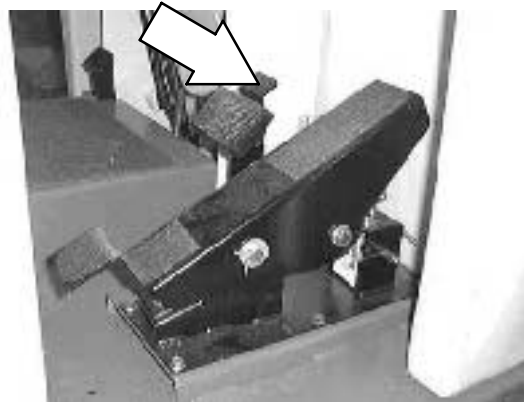

LARGE DEBRIS TRAP PEDAL

The *large debris trap pedal* opens the large debris flap in front of the main sweeping brush.

Open: Press on the trap pedal when sweeping up larger debris. The flap in front of the main sweeping brush will open to take in large debris.

Close: Release the pedal and the flap will close, trapping larger debris into the hopper.



IGNITION SWITCH

The *ignition switch* controls machine power and main sweeping brush with a key.

Start: Turn the key all the way clockwise, and release the key as soon as the engine starts. The vacuum fan and main brush both operate while the engine is running.

FOR SAFETY: When starting machine, keep foot on brake and directional pedal in neutral.

Stop: Turn the key counterclockwise.

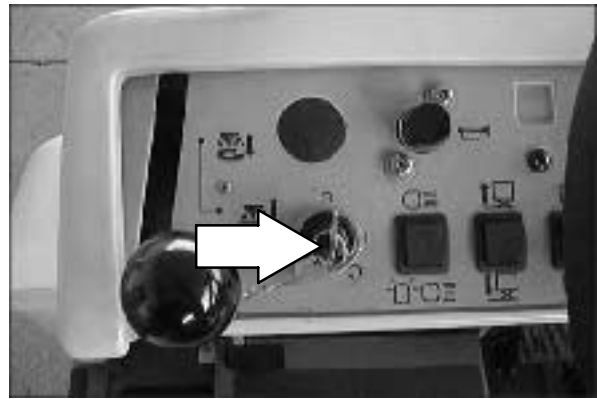

HORN BUTTON

The *horn button* operates the horn.

Sound: Press the button.



SIDE BRUSH LEVER

The *side brush lever* controls the position and the power of the side brush.

Side brush down and on: Pull the lever left and forward into the **Side brush down and on** position. The brush will automatically start rotating.

Side brush up and off: Pull the lever back and to the right into the **Side brush up and off** position.

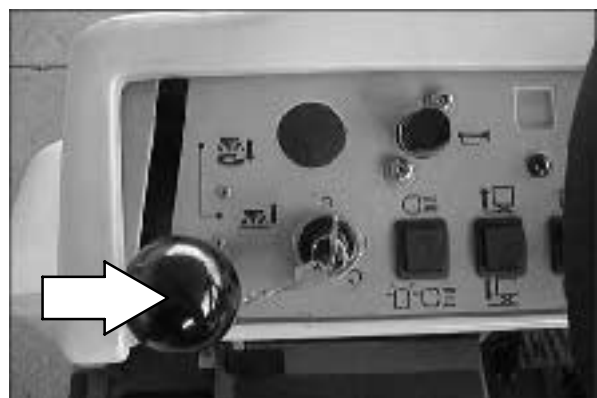

OPERATION

OPERATING LIGHTS SWITCH (OPTION)

The *operating lights switch* powers on and off the headlights and taillights option.

On: Press the top of the operating lights switch.

Off: Press the switch to the middle position.

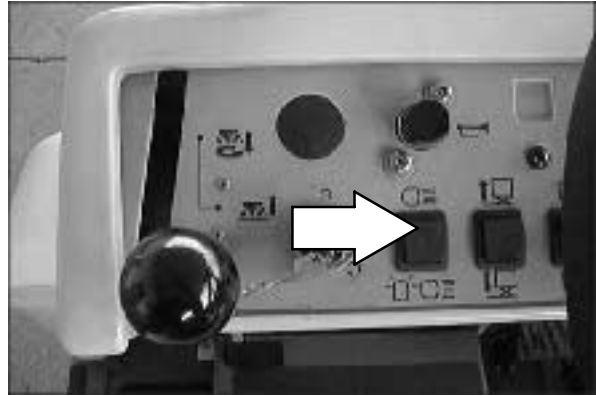

OPERATING/HAZARD LIGHTS SWITCH (OPTION)

The *operating/hazard lights switch* powers on and off the headlights and taillights option and the hazard light option.

Operating lights on: Press the top of the operating/hazard lights switch.

Operating/Hazard lights on: Press the bottom of the operating/hazard lights switch.

Off: Press the operating/hazard lights switch in the middle position.

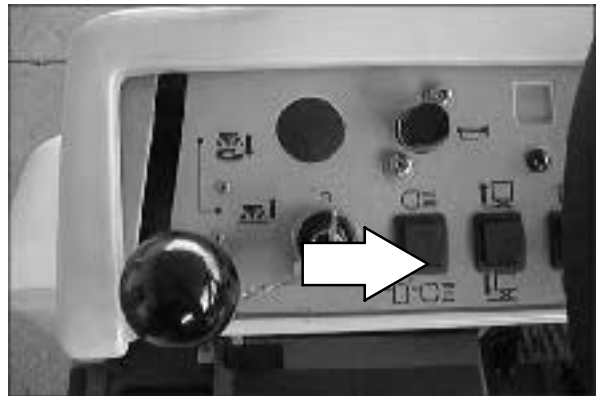

MAIN BRUSH LEVER

The *main brush lever* controls the position of the main brush.

Main brush down: Pull the lever to the right and back into the **Main brush down** position.

Main brush up: Push the lever up and to the left into the **Main brush up** position.



CHARGING SYSTEM LIGHT

The *charging system light* comes on when the alternator is not operating within the normal range; 13.5 to 14.5 V. If the light comes on, stop operating the machine. Locate the problem and have it corrected.

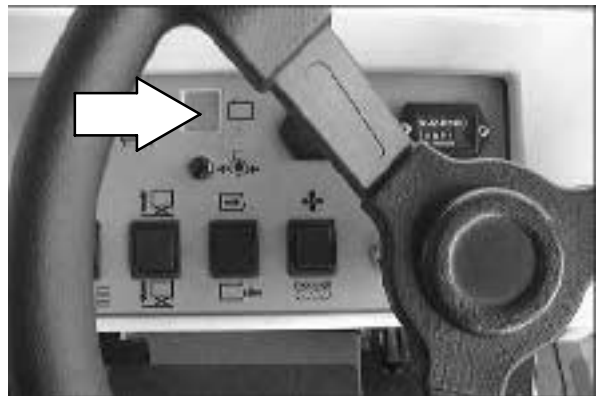

LOW OIL WARNING INDICATOR

The low oil warning indicator will illuminate when the engine oil level drops below a certain level. When the engine oil level is too low, the engine will automatically shut itself off.

The engine will not restart and the indicator will not go out until the proper amount of engine oil has been added.

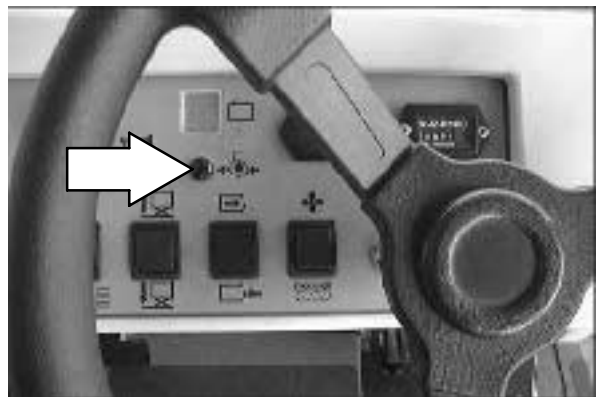

OPERATION

FUEL LEVEL GAUGE

The LPG *fuel level gauge* is located on the top of the fuel tank. It indicates how much fuel is left in the fuel tank.

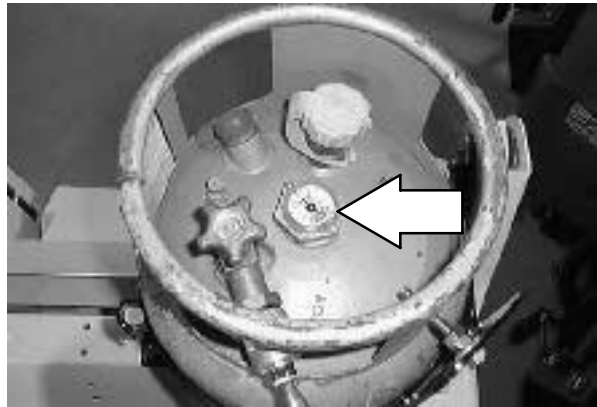

The *fuel level gauge* for gasoline powered machines serial number 002389 and above, is located on the instrument panel. It indicates how much fuel is left in the fuel tank.

NOTE: Do not use leaded fuels. The use of leaded fuels will cause permanent damage to the system's oxygen sensor and catalytic converter.



Gasoline powered machines below serial number 002389 do not have a fuel level gauge. Check the fuel level by looking into the fuel tank.

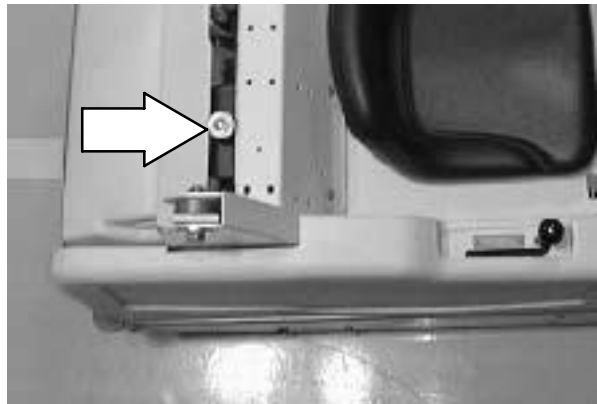

GASOLINE ENGINE CHOKE KNOB

The *engine choke knob* controls the engine choke on gasoline powered machines.

On: For cold starting, pull the engine choke knob out.

Off: Push the engine choke knob in.

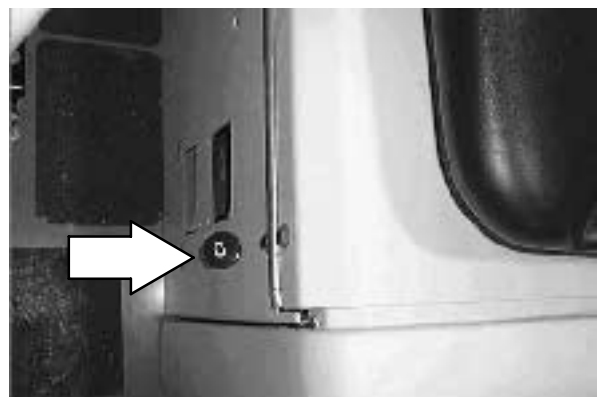

VACUUM FAN/ FILTER SHAKER SWITCH

The *vacuum fan/filter shaker switch* controls both the vacuum fan damper and the VCS *Vibrating Comb Shaker*. The vacuum fan damper should be open when sweeping dry debris, and closed when sweeping wet debris.

Vacuum fan damper open: Press the top of the switch to the **vacuum fan damper open** position for dry sweeping.

Vacuum fan damper closed: Press the switch to the middle **vacuum fan damper closed** position for wet sweeping.

Start filter shaker: **Press and hold** the bottom of the switch for eight to ten seconds.

Note: Excessive heat in the hopper will cause the Thermo Sentry to close the vacuum fan damper. If this happens, stop the machine, eliminate the source of heat, and reset the switch to the vacuum fan damper open position.

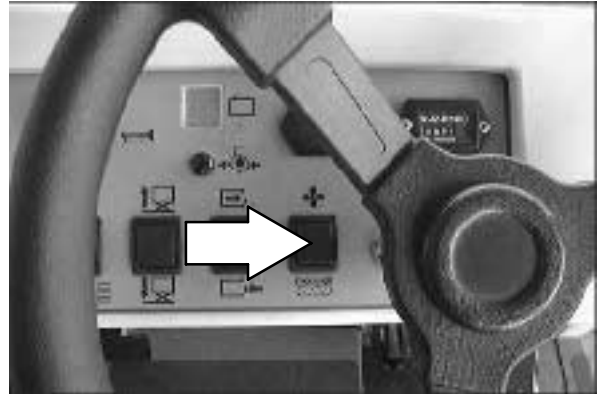

STEERING WHEEL

The *steering wheel* controls the machine's direction. The machine is very responsive to the steering wheel movements.

Left: Turn the steering wheel to the left.

Right: Turn the steering wheel to the right.

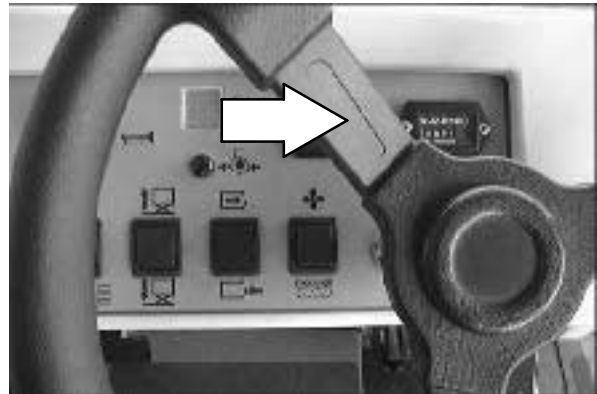

HOURMETER

The *hourmeter* records the number of hours the machine has been operated. The hourmeter displays the number of hours in tenths of an hour. Use this information to determine machine maintenance intervals.

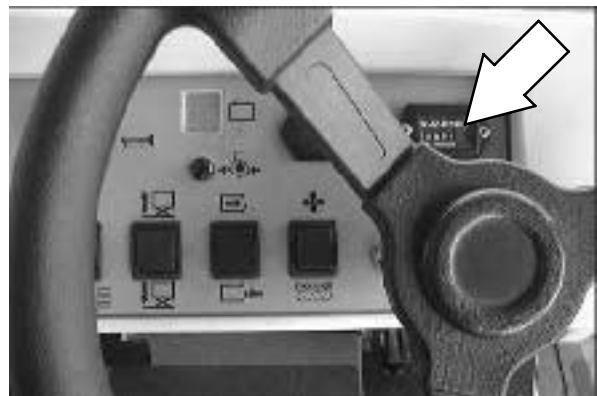

OPERATION

HOPPER SWITCH

The *hopper switch* raises and lowers the hopper.

Raise hopper: **Press and hold** the top of the switch until the hopper is in the desired raised position.

Hold: Release the hopper switch into the middle position.

Lower hopper: **Press and hold** the bottom of the switch until the hopper is in the desired lowered position.

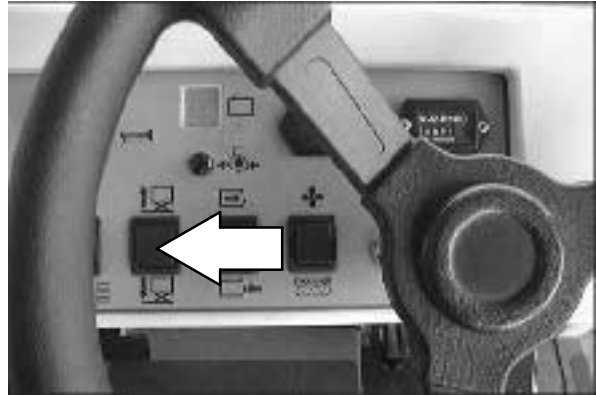

HOPPER DOOR SWITCH

The *hopper door switch* opens and closes the hopper door.

Open hopper door: **Press and hold** the top of the switch until the door is in the desired open position.

Hold: Release the hopper door switch into the middle position.

Close hopper door: **Press and hold** the bottom of the switch until the door is in the desired closed position.

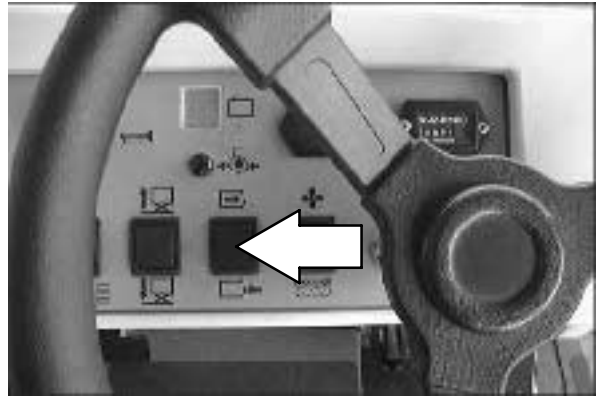

CIRCUIT BREAKERS

The *circuit breakers* are resettable electrical circuit protection devices. Their design stops the flow of current in the event of a circuit overload. Once a circuit breaker is tripped, it must be reset manually. Press the reset button after the breaker has cooled down. The circuit breakers will not reset until they have had a chance to cool down.

If the overload that caused the circuit breaker to trip is still there, the circuit breaker will continue to stop current flow until the problem is corrected.

Circuit breakers 1 through 7 are located above the foot pedals in the circuit breaker panel.

The chart lists the circuit breakers and the electrical components they protect.

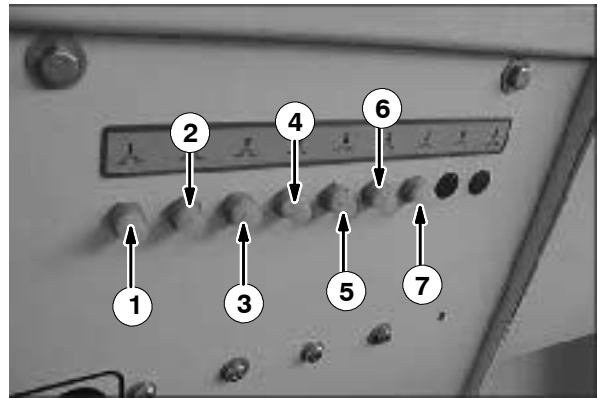

Circuit Breaker	Rating	Circuit Protected
CB-1	15 A	Horn, Reverse, Back up alarm
CB-2	15 A	Filter shaker
CB-3	15 A	Side brush(es)
CB-4	40 A	Hopper lift motor
CB-5	15 A	Main
CB-6	15 A	Hopper door
CB-7	15 A	Headlight, Taillight Warning light

OPERATION

OPERATOR SEAT

The *operator seat* is a fixed back style.



ADJUSTABLE OPERATOR SEAT (OPTION)

The *adjustable operator seat* is a fixed back style with a forward-backward adjustment.

Adjust: Pull the lever in, slide the seat backward or forward to the desired position, and release the lever.

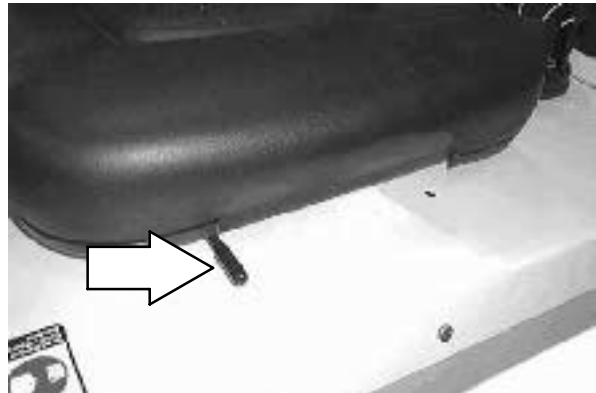

DELUXE SUSPENSION SEAT (OPTION)

The *deluxe suspension seat* has four adjustments. The adjustments are for the lumbar support, backrest angle, operator weight adjustment and front to back adjustment.

The *lumbar adjustment knob* controls the firmness of the lumbar support.

Increase firmness: Turn knob clockwise.

Decrease firmness: Turn knob counterclockwise.



The *backrest angle knob* adjusts the angle of the backrest.

Increase angle: Turn the angle adjustment knob counterclockwise.

Decrease angle: Turn the angle adjustment knob clockwise.



The *weight adjustment knob* controls the firmness of the operator's seat.

Increase firmness: Turn the weight adjustment knob clockwise.

Decrease firmness: Turn the weight adjustment knob counterclockwise.

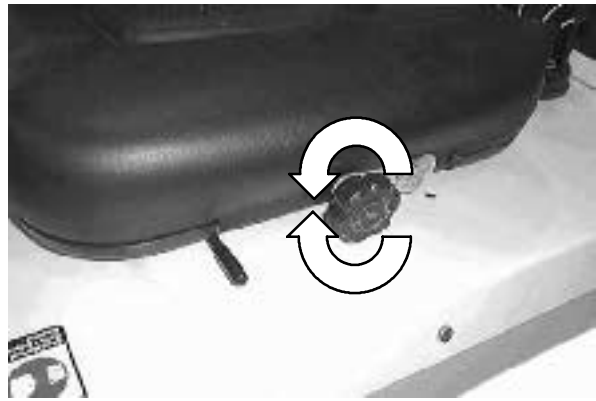

Use the gauge next to the weight adjustment knob to help determine proper seat firmness for the operator.

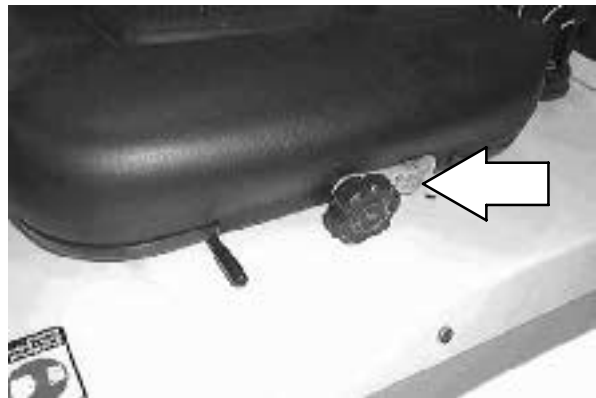

The *front-to-back adjustment lever* adjusts the seat position.

Adjust: Pull the lever out and slide the seat forward or backward to the desired position. Release the lever.

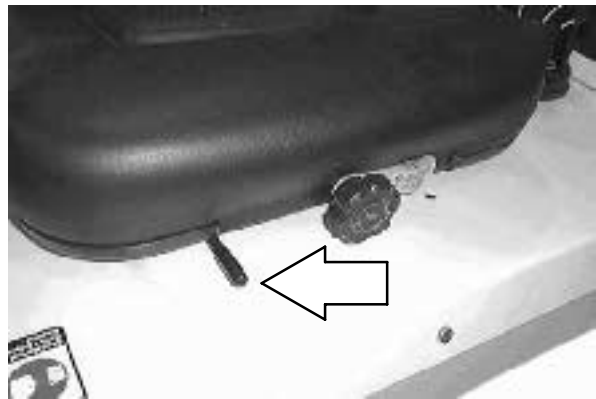

HOPPER SUPPORT BAR

The *hopper support bar* is located on the hydraulic cylinder. It is manually moved into place when the cylinder is fully extended to prevent the hopper from lowering. Lift it off the cylinder before lowering the hopper.

 **WARNING: Raised hopper may fall.**
Engage hopper support bar



HOW THE MACHINE WORKS

The steering wheel controls the direction of machine travel. The directional pedal controls the speed and forward/reverse direction. The brake pedal slows and stops the machine.

The side brush sweeps debris into the path of the main sweeping brush. The main brush sweeps debris from the floor into the hopper. The large debris trap pedal opens and closes the large debris trap, kicking large debris into the hopper. The vacuum system pulls dust and air into the hopper through the Instant Access filter.

When sweeping is finished, clean the Instant Access filter and empty the hopper.

PRE-OPERATION CHECKLIST

- Check the engine oil level.
- Check the hydraulic fluid level
- Check the air filter indicator.
- Check the skirts and seals for damage and wear.
- Check the condition of the sweeping brushes. Remove any string, banding, plastic wrap, or other debris wrapped around them.
- Check the sweeping brush patterns for adjustment.
- Check the condition of the hopper dust filter and seals. Clean as required.
- Check the brakes and steering for proper operation.
- Check the fuel level
- Empty the debris hopper.
- Check the service records to determine maintenance requirements.

CHANGING AN LPG FUEL TANK

1. Park the machine in a designated safe area.
2. Close the tank service valve on the LPG tank located under the operator seat.
3. Operate the engine until it stops from lack of fuel, then set the machine parking brake.

FOR SAFETY: When servicing machine, keep flames and sparks away from fuel system service area. Keep area well ventilated.

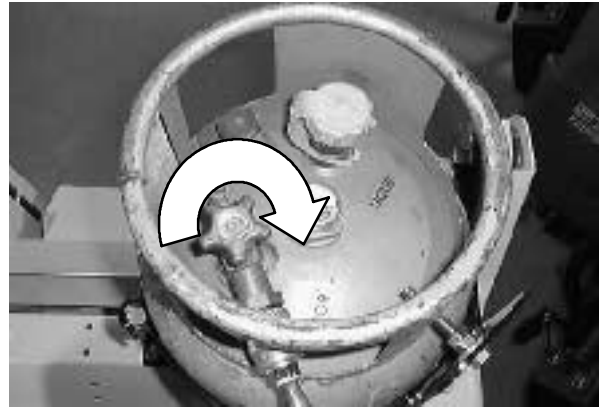

4. Put on gloves and remove the quick-disconnect tank coupling.
5. Unlatch and remove the empty LPG fuel tank from the machine and store the tank in a designated, safe area.

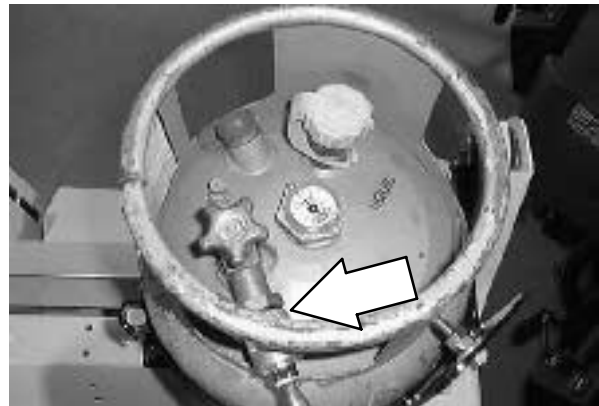

6. Carefully put the filled LPG tank in the machine so that the tank centering pin enters the aligning hole in the tank collar.

NOTE: Make sure the LPG fuel tank matches the fuel system (vapor tank with vapor system).

7. Fasten the tank hold-down clamp to lock the tank in position.

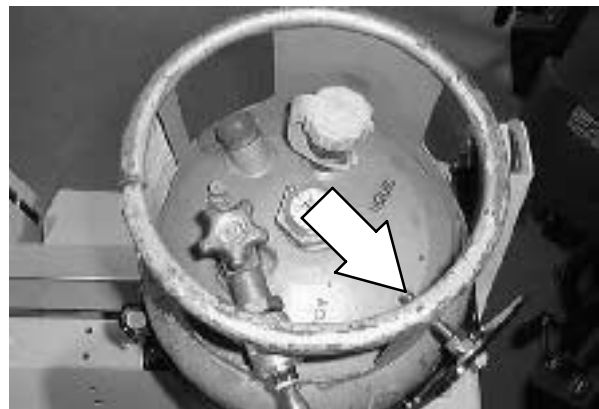

OPERATION

8. Connect the LPG fuel line to the tank's vapor service coupling. Make sure the service coupling is clean and free of damage. Also make sure it matches the machine service coupling.

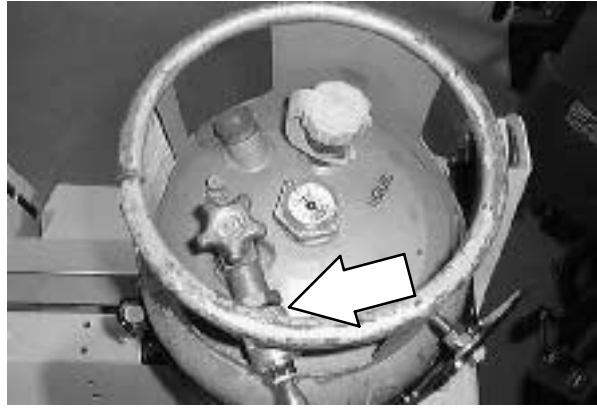

9. Open the tank service valve slowly and check for leaks. Close the service valve immediately if an LPG leak is found, and tell the appropriate personnel.

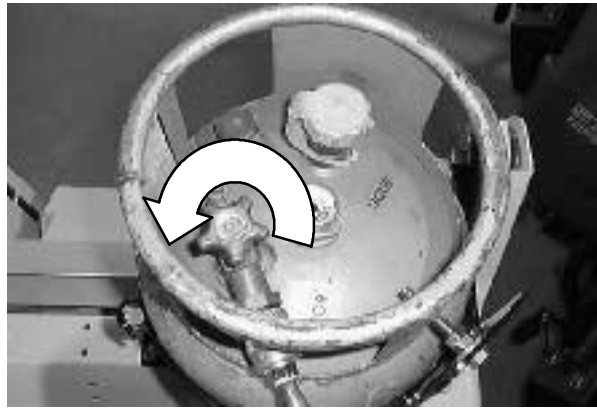

STARTING THE MACHINE

1. LPG powered machines: Open the vapor service valve slowly.

NOTE: Opening the service valve too quickly may cause the service check valve to stop the flow of LPG fuel. If the check valve stops the fuel flow, close the service valve, wait a few seconds and open the valve slowly again.

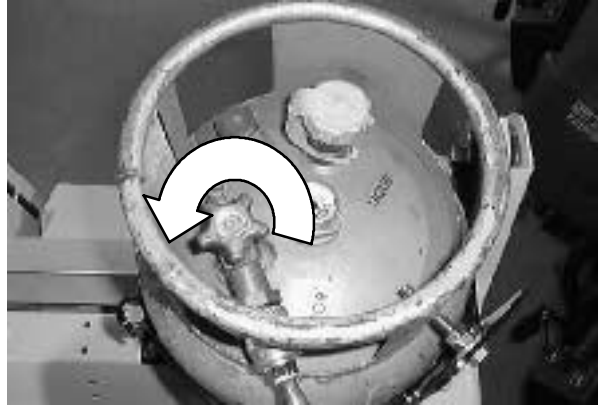

2. Sit in the operator's seat and engage the brakes with the directional pedal in neutral.

FOR SAFETY: When starting machine, keep foot on brake and directional pedal in neutral.

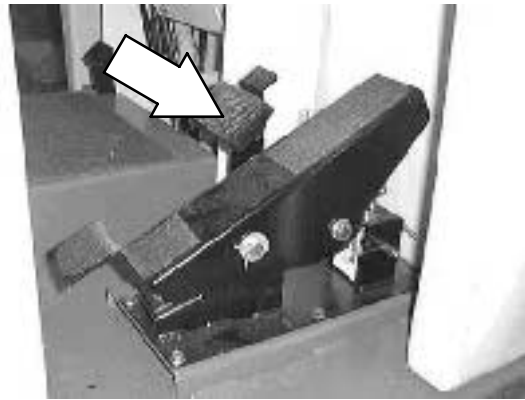

3. Pull out the choke knob for the gasoline engine when the engine is cold. Push in the choke knob after the engine is running smoothly.

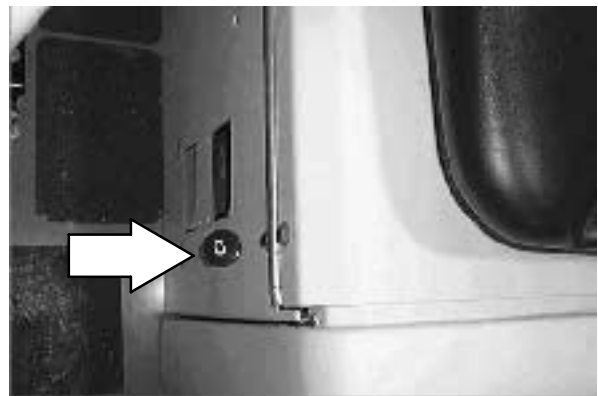

OPERATION

4. Turn the ignition switch key clockwise until the engine starts.

NOTE: Do not operate the starter motor for more than 10 seconds at a time or after the engine has started. Allow the starter to cool between starting attempts or damage to the starter motor may occur.

5. Allow the engine to warm up two to three minutes.

⚠ WARNING: Engine emits toxic gases. Severe respiratory damage or asphyxiation can result. Provide adequate ventilation. Consult with your regulatory authorities for exposure limits. Keep engine properly tuned.

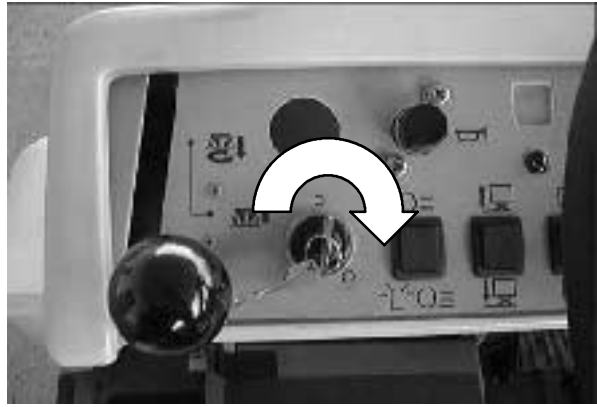

6. Release the machine parking brake.

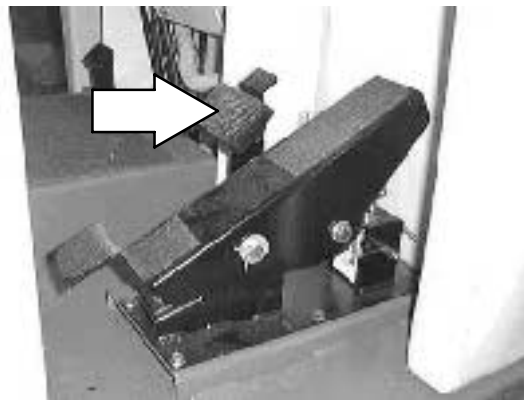

7. Drive the machine to the area to be cleaned.

OPERATION ON INCLINES

Drive the machine slowly on inclines. Use the brake pedal to control machine speed when descending inclines.

The maximum rated incline is 6°/11% with a full hopper and 10°/18% with an empty hopper.

FOR SAFETY: When using machine, go slowly on inclines and slippery surfaces.

SWEEPING AND BRUSH INFORMATION

Pick up oversized debris before sweeping. Flatten or remove bulky cartons from aisles before sweeping. Pick up pieces of wire, twine, string, etc., which could become entangled in the brush or brush plugs.

Plan the sweeping in advance. Try to arrange long runs with minimum stopping and starting. Do an entire floor or section at one time. Drive the straightest path possible. Avoid bumping into posts or scraping the sides of the machine. Overlap the brush paths.

Avoid turning the steering wheel too sharply when the machine is in motion. The machine is very responsive to the movement of the steering wheel. Avoid sudden turns, except in emergencies.

For best results, use the correct brush type for your sweeping application. The following are recommendations for main sweeping and side brush applications.

Polypropylene 8-single row main brush -

Superior pick-up of sand, gravel, and paper litter. Polypropylene retains its stiffness when wet and can be used indoors or outdoors with equal performance. Not recommended for high-temperature debris.

Natural Fiber main brush - The natural choice for cleaning fine debris on carpet and sweeping very heavy dust and other fine particles on hard surfaces. When cleaning carpet, check brush and perma filter panel regularly for carpet debris.

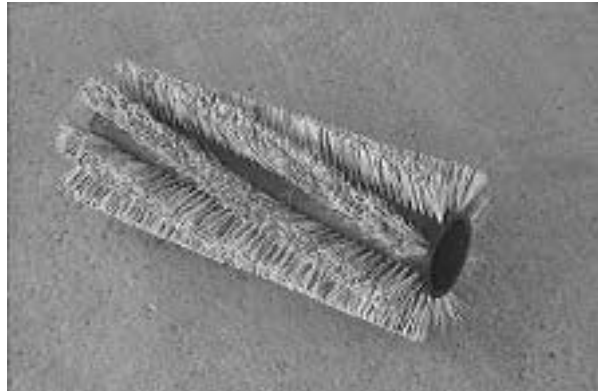

Sand wedge main brush - A fine brush that handles large quantities of dust and sand with ease.



OPERATION

Side Brush (2 Row) – A good general purpose brush for sweeping of light to medium debris in both indoor and outdoor applications. This brush is recommended when bristles may get wet.

Side Brush (3 Row) – Improved sweeping performance of fine materials on smooth indoor surfaces.

Stiff Side Brush – A longer life, general purpose brush that is recommended for rough surfaces.



SWEEPING

1. Press the top of the vacuum fan/filter shaker switch to the vacuum fan damper open position.

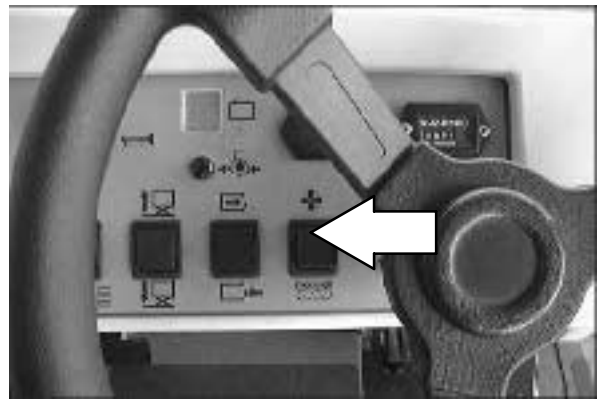

2. Lower the main brush with the main brush lever.

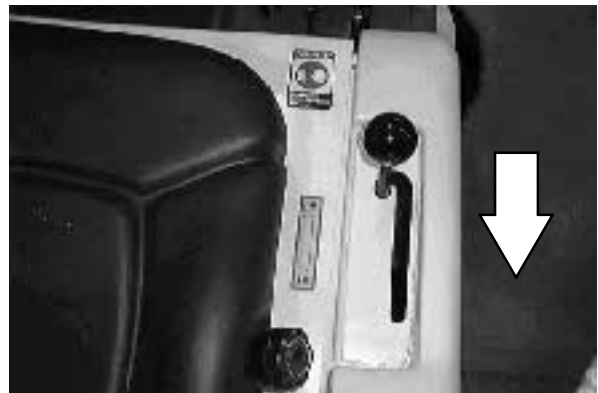

3. Lower and start the side brush with the side brush lever.



4. Begin sweeping.

5. Press down on the large debris trap pedal when sweeping large debris.



6. Release the pedal, and the flap will lower over the debris.

7. The flap will trap large debris back into the hopper.

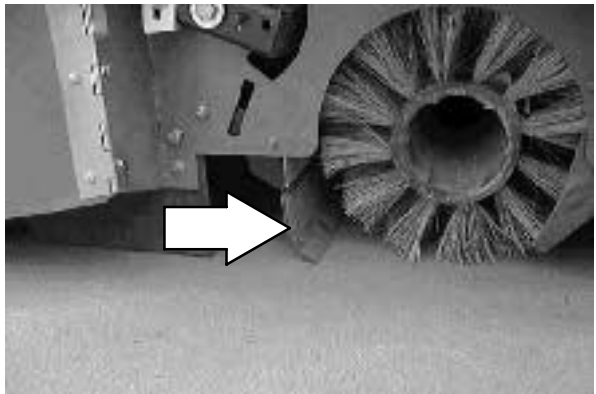

OPERATION

STOP SWEEPING

1. Raise and stop the side brush with the side brush lever.

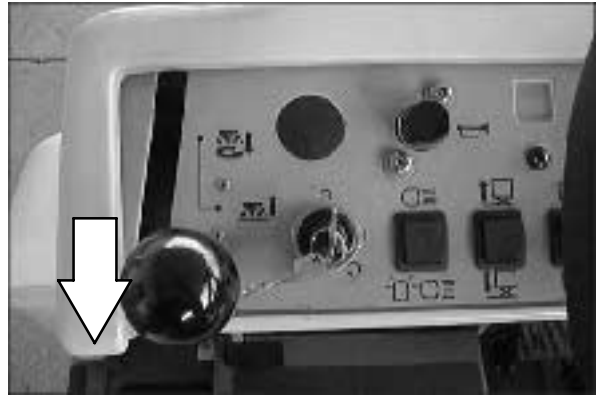

2. Raise the main brush with the main brush lever.



3. Activate the filter shaker by pressing down and holding the bottom of the vacuum fan/filter shaker switch for eight to ten seconds.

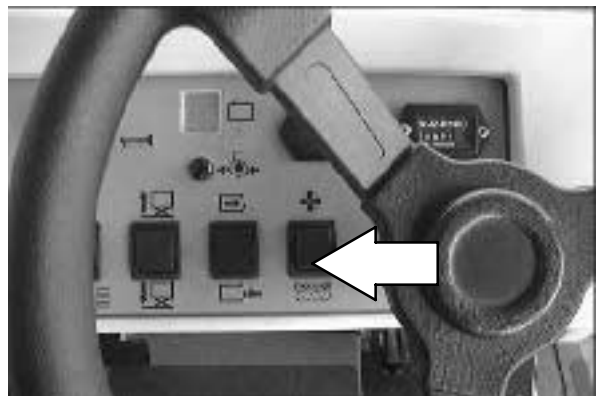

EMPTYING THE HOPPER

1. Stop sweeping. See the STOP SWEEPING section of the manual.
2. Drive the machine to the debris site or debris container.
3. Press and hold the top of the *hopper switch* to raise the hopper to the desired height. Release the switch into the hold position.

FOR SAFETY: When using machine, make sure adequate clearance is available before raising hopper.

 **WARNING:** Lift arm pinch point. Stay clear of hopper lift arms.

NOTE: Be aware that the minimum ceiling height needed to high dump the hopper is 2286 mm (90 in).

4. Back the machine up to the debris container. Position the hopper over the debris container.

FOR SAFETY: When using machine, use care when reversing machine.

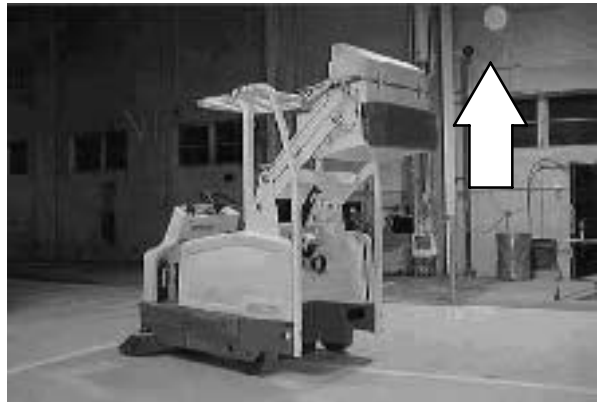
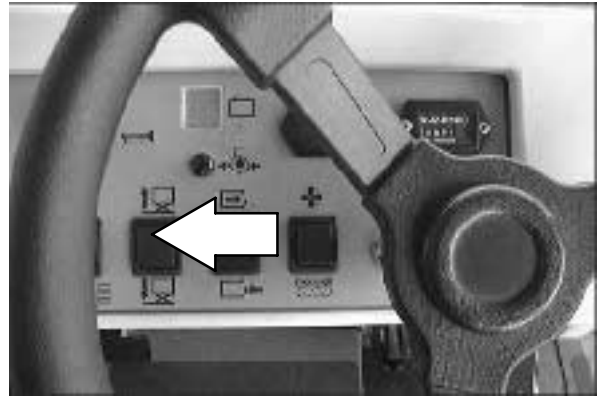

OPERATION

5. Press and hold the top of the *hopper door switch* until the hopper is fully open. Release the switch into the hold position.

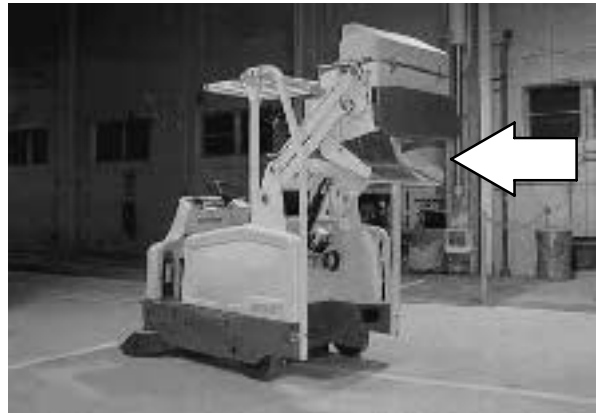
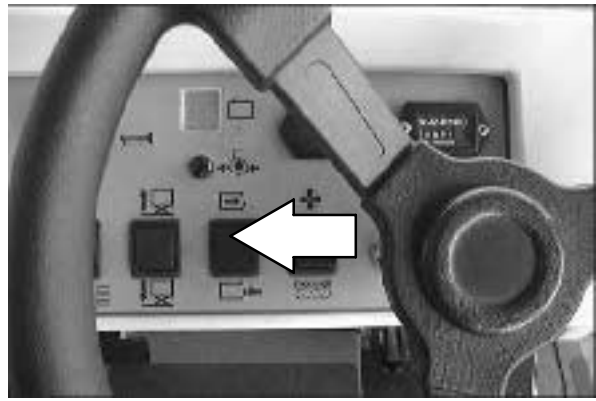

6. Press and hold the bottom of the *hopper door switch* until the hopper door is fully closed.

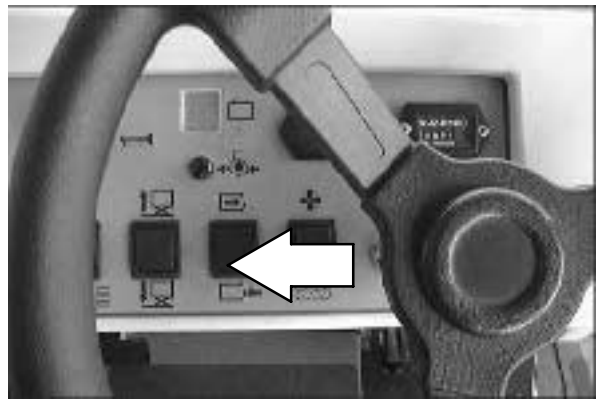

7. Press and hold the bottom of the *hopper switch* until the hopper is fully lowered.

 **WARNING: Lift arm pinch point. Stay clear of hopper lift arms.**

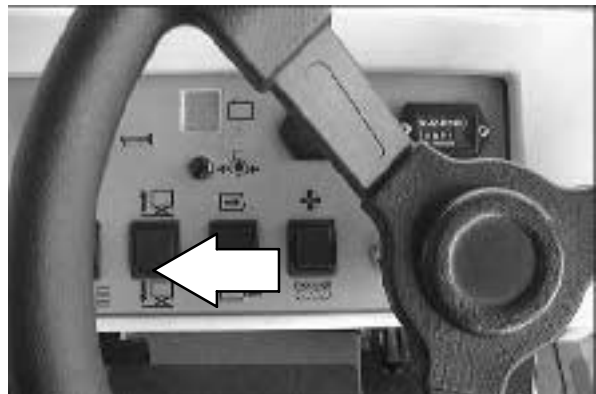

STOPPING THE MACHINE

1. Stop sweeping. See the STOP SWEEPING section of the manual.
2. Take your foot off the directional pedal. Step on the brake pedal.

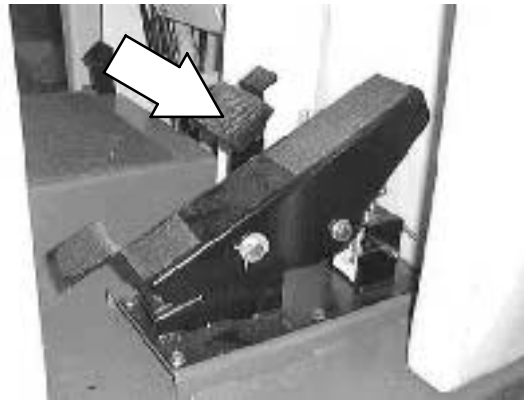

3. Set the machine parking brake.

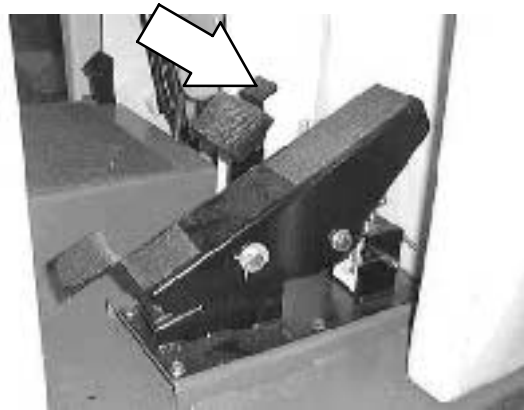

4. Turn the ignition switch key counterclockwise to turn the machine power off. Remove the switch key.

FOR SAFETY: Before leaving or servicing machine, stop on level surface, set parking brake, turn off machine, and remove key.

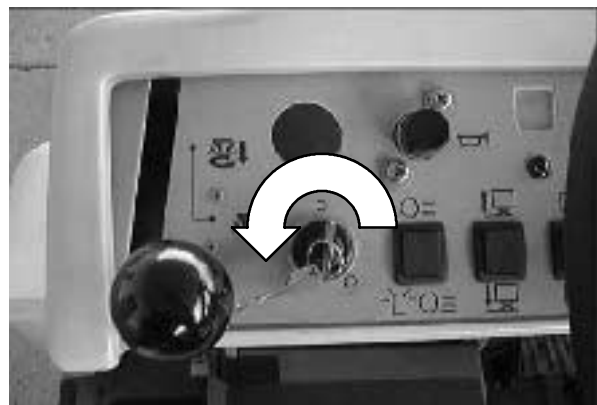

5. LPG powered machines: Close the LPG tank's vapor service valve.

POST-OPERATION CHECKLIST

Check this list of items after you have finished sweeping:

- Check the engine oil level.
- Check the hydraulic fluid level
- Check the air filter indicator.
- Check the skirts and seals for damage and wear.
- Check the condition of the sweeping brushes. Remove any string, banding, plastic wrap, or other debris wrapped around them.
- Check the sweeping brush patterns for adjustment.
- Check the condition of the hopper dust filter and seals. Clean as required.
- Check the brakes and steering for proper operation.
- Check the fuel level
- Empty the debris hopper.
- Check the service records to determine maintenance requirements.

ENGAGING HOPPER SUPPORT BAR

1. Set the machine parking brake.

FOR SAFETY: When starting machine, keep foot on brake and directional pedal in neutral.

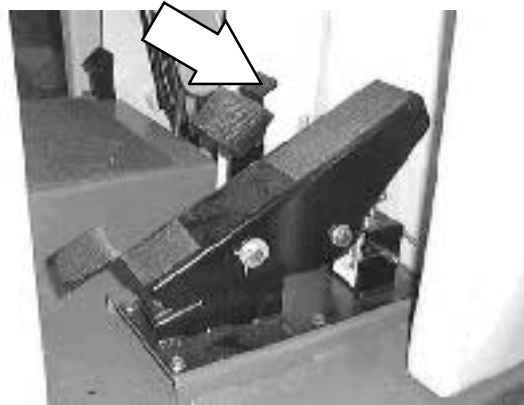

2. Start the machine.



3. Press and hold the top of the hopper switch until the hopper is fully raised. Release the switch into the hold position.

⚠ WARNING: Lift arm pinch point. Stay clear of hopper lift arms.

FOR SAFETY: When using machine, make sure adequate clearance is available before raising hopper.

NOTE: Be aware that the minimum ceiling height needed to high dump the hopper is 2286 mm (90 in).

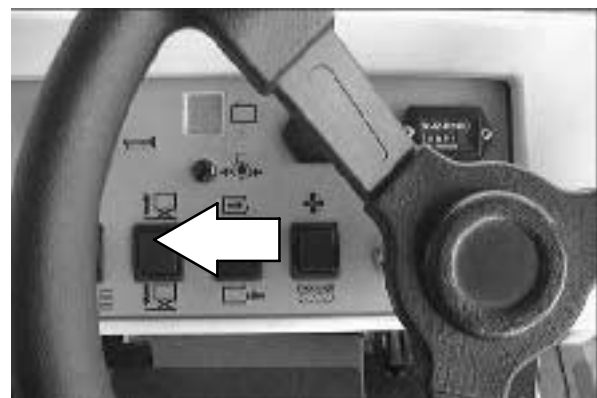

OPERATION

4. Push the hopper support bar in place onto the support cylinder.

 **WARNING: Raised hopper may fall. Engage hopper support bar**

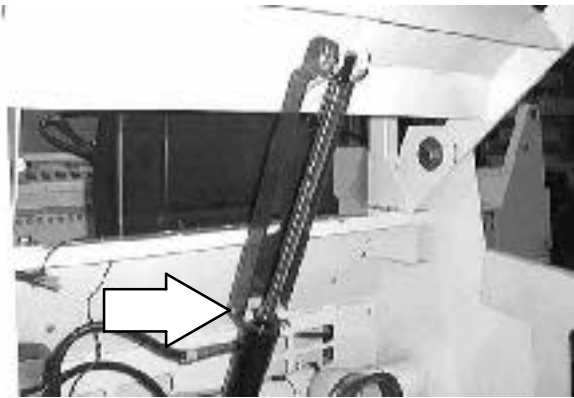

5. Slowly lower the hopper by pressing down and holding the *hopper switch* until the hopper support bar rests on the support bar stop.

 **WARNING: Lift arm pinch point. Stay clear of hopper lift arms.**

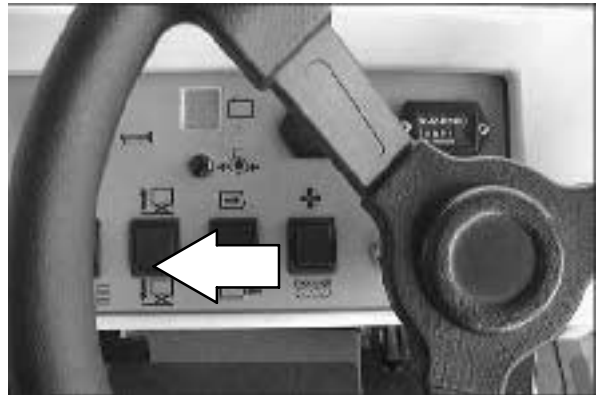

6. Turn the machine power off.

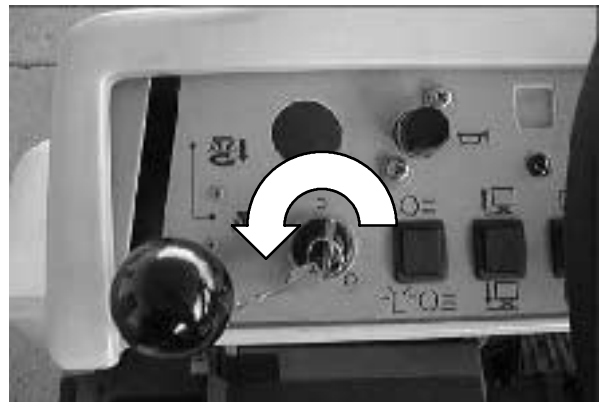

DISENGAGING HOPPER SUPPORT BAR

1. Start the machine.

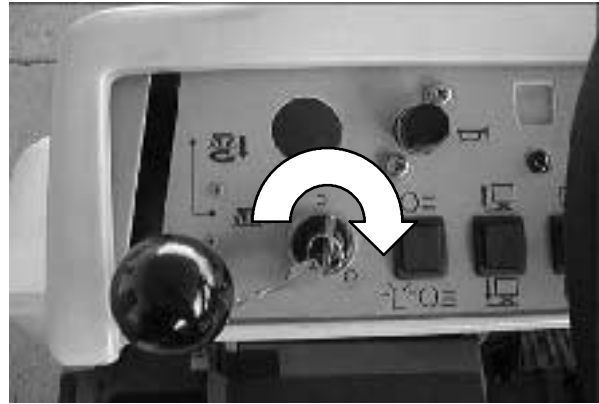

2. Raise the hopper slightly by pressing up and holding the *hopper switch*. Release the switch into the hold position.

NOTE: Be aware that the minimum ceiling height needed to high dump the hopper is 2286 mm (90 in).

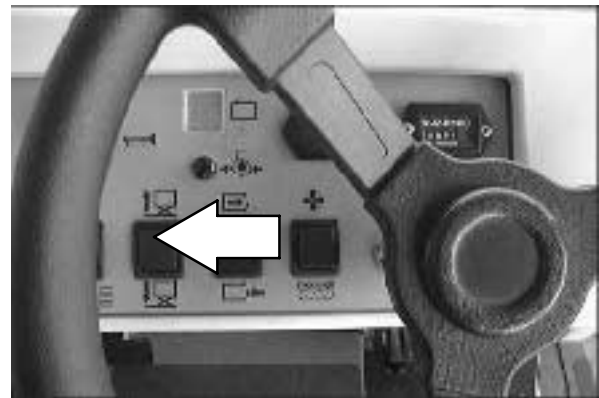

3. Move the hopper support bar off the cylinder into the storage position.

⚠ WARNING: Lift arm pinch point. Stay clear of hopper lift arms.

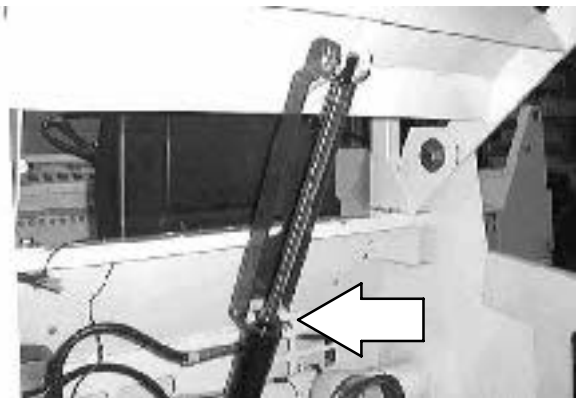

OPERATION

4. Press and hold the bottom of the hopper switch until the hopper is in the fully lowered position.

 **WARNING:** Lift arm pinch point. Stay clear of hopper lift arms.

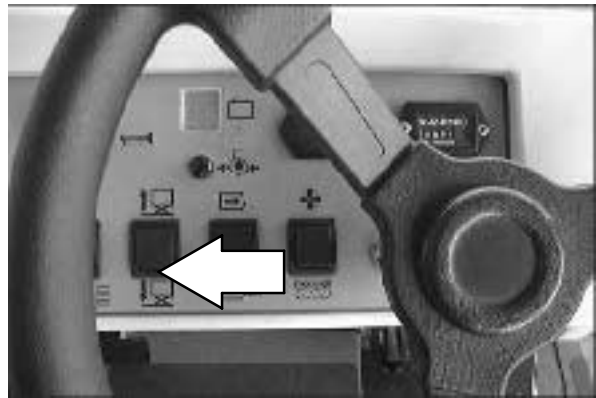

5. Turn the machine power off.

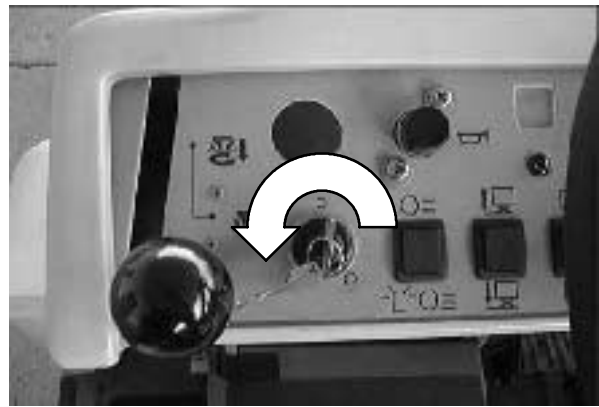

OPTIONS

QUICK MOP

The *QuickMop* is a front end sweeping attachment that widens the machine's sweeping path.

1. Drive the machine close to QuickMop attachment.
2. Set the machine parking brake and turn the machine power off.

FOR SAFETY: Before leaving or servicing machine, stop on level surface, set parking brake, turn off machine, and remove key.



3. Connect the QuickMop attachment to the mounting bracket on the front of the machine.

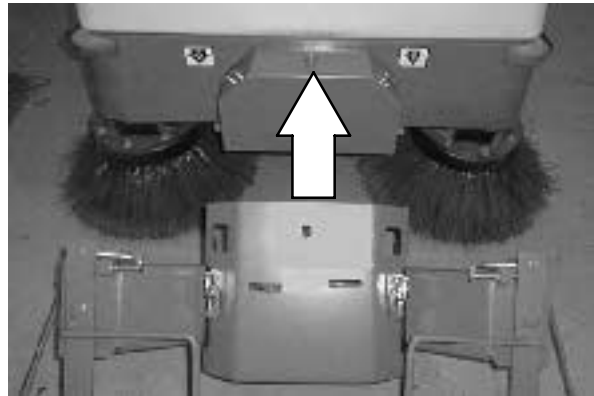

4. Fasten the latches on the front of the mounting bracket. Release the parking brake and drive to the designated area to be swept.



OPERATION

5. Pull the release lever to raise or lower each side of the QuickMop.

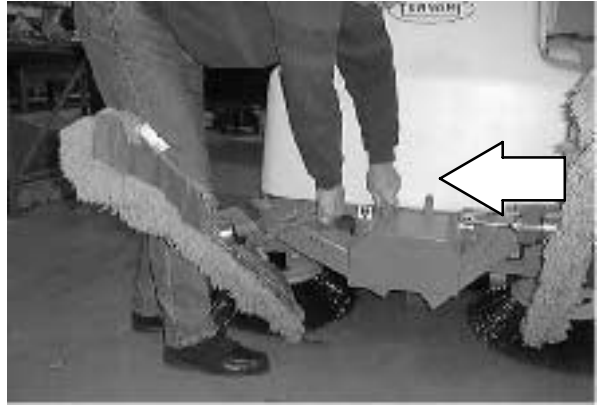

6. Turn the vacuum and brushes on, lower brushes and begin sweeping.



7. Remove and refasten the QuickMop head covers with the easy to remove snaps. Remove the head covers to rotate, shake and clean at regular intervals.

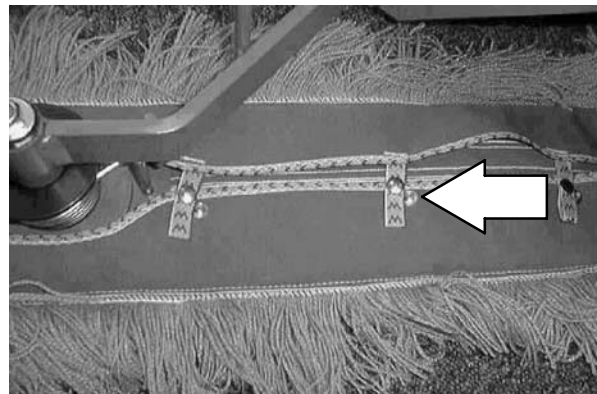

MACHINE TROUBLESHOOTING

Problem	Cause	Remedy
Excessive dusting	Vacuum fan damper closed	Press the vacuum fan / filter shaker switch to the on position
	Brush skirts and dust seals worn, damaged, out of adjustment	Replace or adjust brush skirts or dust seals
	Hopper dust filter clogged	Shake and/or clean or replace dust filter
	Hopper full	Empty hopper
	Vacuum fan failure	Contact Tennant service personnel
	Hopper not fully lowered	Lower hopper
Poor sweeping performance	Brush bristles worn	Replace brushes
	Main and side brushes not adjusted properly	Adjust main and side brushes
	Debris caught in main brush drive mechanism	Remove debris from drive mechanism
	Main brush drive failure	Contact Tennant service personnel
	Side brush drive failure	Contact Tennant service personnel
	Hopper full	Empty hopper
	Hopper lip skirts worn or damaged	Replace lip skirts
	Wrong sweeping brush	Contact Tennant representative for recommendations
	Large debris trap damaged	Repair or replace large debris trap
	Hopper dust filter clogged	Shake and/or clean or replace dust filter
Machine will not start	Engine oil level low	Check and fill
	Fuel tank valve closed	Open valve - LPG tank valve or valve beneath gasoline tank
	Fuel tank empty	Fill fuel tank

MAINTENANCE

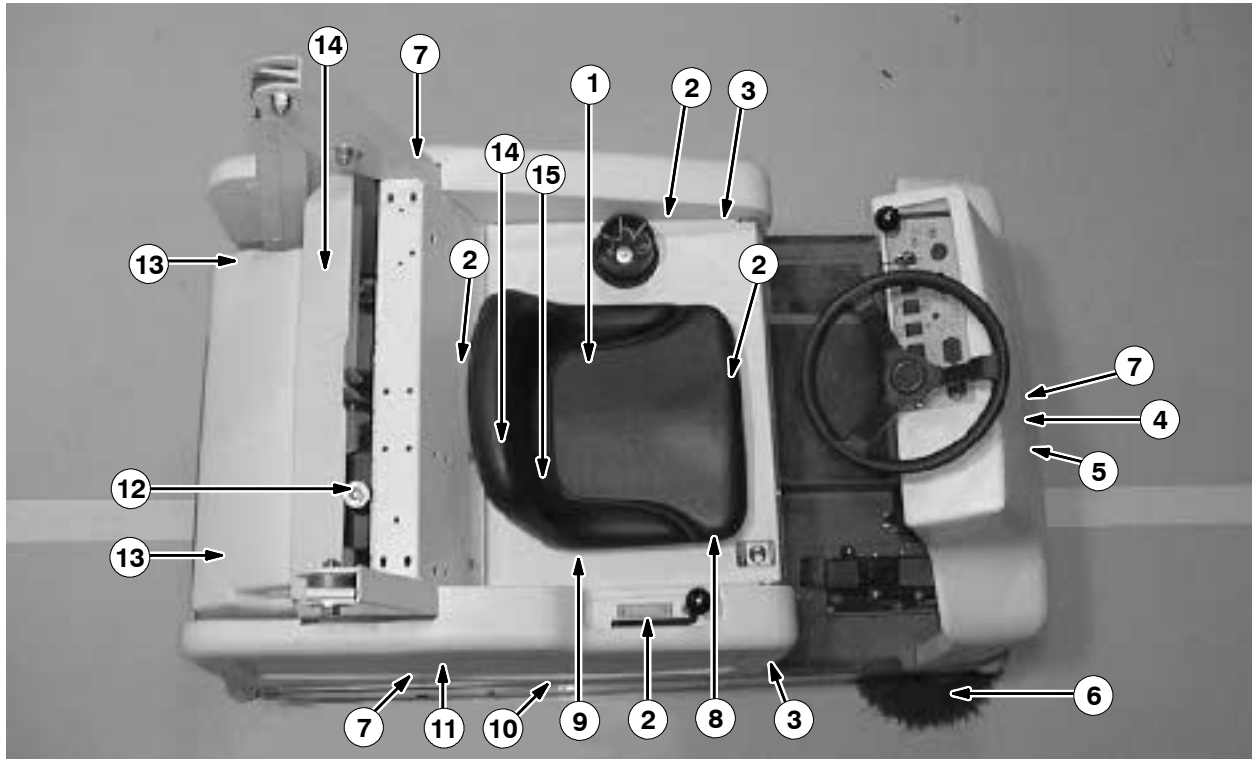

MAINTENANCE CHART

NOTE: Check procedures indicated (■) after the first 50 hours of operation.

Interval	Key	Description	Procedure	Lubricant/ Fluid	No. of Service Points
Daily	1	Engine	Check oil level	EO	1
			Check air intake and cooling areas for debris	-	1
	2	Brush compartment skirts	Check for damage, wear and adjustment	-	5
	3	Side skirts	Check for damage, wear and adjustment	-	2
	9	Main brush	Check for damage, wear and adjustment	-	1
	6	Side brush(es)	Check for damage, wear and adjustment	-	1 (2)
Check brush pattern			-	1 (2)	
25 Hours	1	Engine	Shake	-	1
			Clean and re-oil air filter pre cleaner element	-	1
50 Hours	9	Main brush	Rotate end-for-end	-	1
			Check brush pattern	-	1
	1	Fuel lines	Check for damage and wear	-	All

Interval	Key	Description	Procedure	Lubricant/ Fluid	No. of Service Points
50 Hours	-	QuickMop broom (Option)	Rotate or wash sweep heads	-	2
100 Hours	1	Engine	Change oil	EO	1
			Clean or replace spark plugs	-	1
			Replace air filter element	-	1
			Clean air intake screen and shrouds	-	1
	13	Hopper dust filter	Check for damage, clean or replace	-	1
	7	Tires	Check for damage or wear	-	3
	4	Steering castor pivot bearing	Lubricate	SPL	1
	13	Hopper seals	Check for damage or wear	-	6
	13	Hopper filter seals	Check for damage or wear	-	2
	13	Vacuum seal	Check for damage or wear	-	1
	1	Air intake seal	Check for damage or wear	-	1
	11	Vacuum fan belt	Check tension and wear	-	1
	10	Main brush belt	Check tension and wear	-	1
	14	Hydraulic pump belt	Check tension and wear	-	1
	15	Jackshaft belt	Check tension and wear	-	1
14	Hydraulic fluid reservoirs	Check fluid levels	-	2	
200 Hours	5	Brake	Check adjustment	-	1
	4	Steering gear chain	Lubricate	EO	1
	6	Side brush(es) guard	Check for damage or wear	-	1 (2)
800 Hours	14	Hydraulic hoses	Check for wear and damage	-	All
	14	Main hydraulic reservoir cap	Replace cap	-	1
	7	Wheels	Check rear wheel axle torque	-	2
	8	Battery	■ Clean and tighten battery cable connections	-	2
1200 Hours	14	Hydraulic fluid filter	* Change filter element	-	All
2400 Hours	14	Hydraulic fluid reservoir	* Replace suction strainer	-	1
			* Change hydraulic fluid	HYDO	1

NOTE: Change the hydraulic fluid, filter, and suction strainer, indicated (), after every 800 hours for machines NOT originally equipped with **TennantTrue** premium hydraulic fluid. (See Hydraulics section).*

LUBRICANT/FLUID

EO . . . Engine oil, 30 SAE-SG/SH rated

HYDO . **TennantTrue** premium hydraulic fluid or equivalent

SPL . . . Special lubricant, Lubriplate EMB grease (TENNANT part no. 01433-1)

NOTE: More frequent intervals may be required in extremely dusty conditions.

MAINTENANCE

LUBRICATION

ENGINE

Check the engine oil level daily. Change the engine oil after every 100 hours of operation. Use 30 SAE SG/SH rated engine oil.

Fill the engine with oil to the level indicated on the oil dipstick. The engine oil capacity is 1.2 L (1.3 qt.).

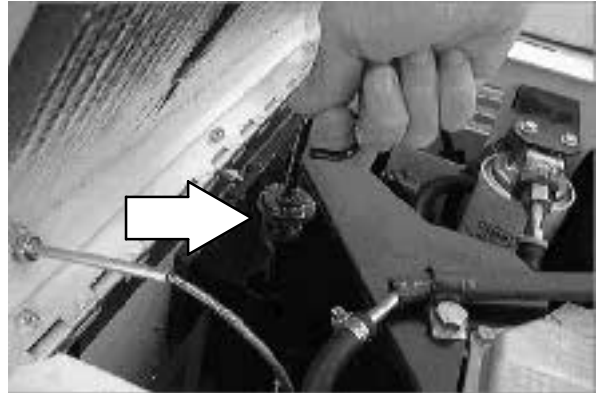

STEERING GEAR CHAIN

The steering chain turns the front wheel as the steering wheel is turned to steer the machine. Lubricate the steering chain with 30 SAE engine oil after every 200 hours of operation.

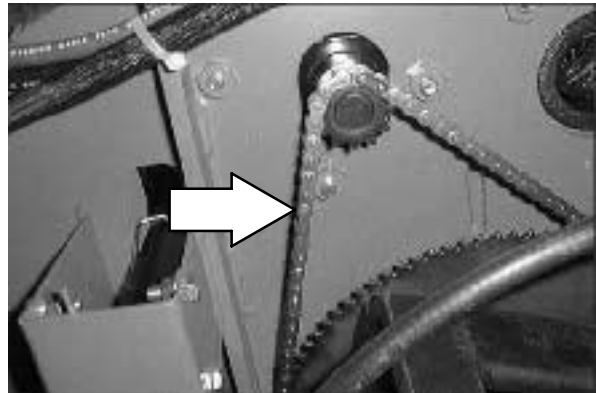

STEERING CASTOR PIVOT BEARING

The steering castor bearing is located under the floor plate. Remove the floor plate, and lubricate the bearing every 100 hours with Lubriplate EMB grease (TENNANT part no. 01433-1).

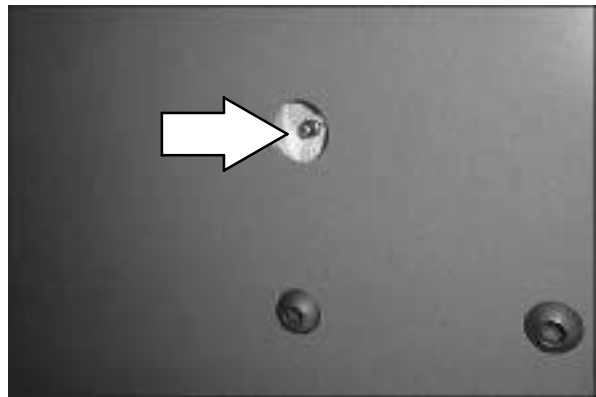

HYDRAULICS

HYDRAULIC FLUID RESERVOIRS

The 6200 has two hydraulic fluid reservoirs, the main hydraulic reservoir and the hopper lift reservoir.

The main hydraulic reservoir is located in the engine compartment.

A filler cap is mounted on top of the main reservoir. It has a built-in breather and fluid level dipstick. Lubricate the filler cap gasket with a film of hydraulic fluid before putting the cap back on the reservoir. Replace the cap after every 800 hours of operation.

Check the hydraulic fluid level of the main reservoir at operating temperature after every 100 hours of operation. The end of the dipstick is marked with FULL and ADD levels to indicate the level of hydraulic fluid in the reservoir.

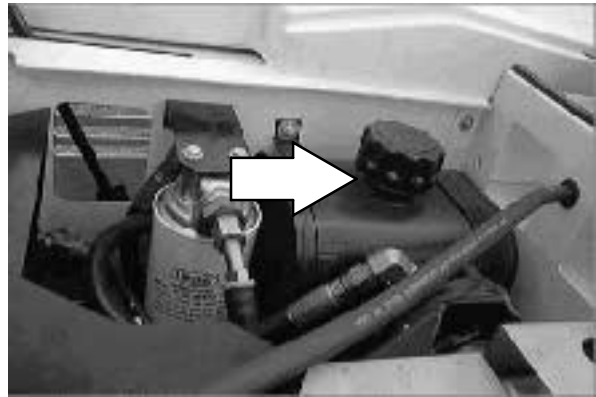

ATTENTION! Do not overfill the hydraulic fluid reservoir or operate the machine with a low level of hydraulic fluid in the reservoir. Damage to the machine hydraulic system may result.

Drain and refill the hydraulic fluid reservoir with new **TennantTrue** premium hydraulic fluid after every 2400 hours of operation. Machines have a blue colored drop (left photo) on the hydraulic fluid label if originally equipped with **TennantTrue** premium hydraulic fluid.

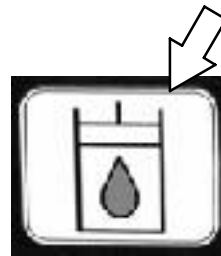

TennantTrue Fluid



Previous Fluid

*NOTE: Change the hydraulic fluid, filter, and suction strainer after every 800 hours for ALL machines that have NOT consistently used **TennantTrue** premium hydraulic fluid or equivalent.*

The main hydraulic reservoir has a built-in strainer outlet that filters hydraulic fluid before it enters the system. Replace the strainer after every 2400 hours of operation.

The hydraulic fluid filter is located in the engine compartment next to the hydraulic reservoir. Replace the filter element after every 1200 hours of operation.



The hydraulic hopper lift reservoir is located behind the hopper compartment.

A filler cap is mounted on top of the reservoir. It is not a breather cap, and requires no regular maintenance.

Check the hydraulic fluid level of the hopper lift reservoir at operating temperature after every 100 hours of operation. Make sure the hopper support bar is in place before checking hydraulic fluid level. The side of the reservoir is marked with FULL and ADD levels to indicate the level of hydraulic fluid in the reservoir.

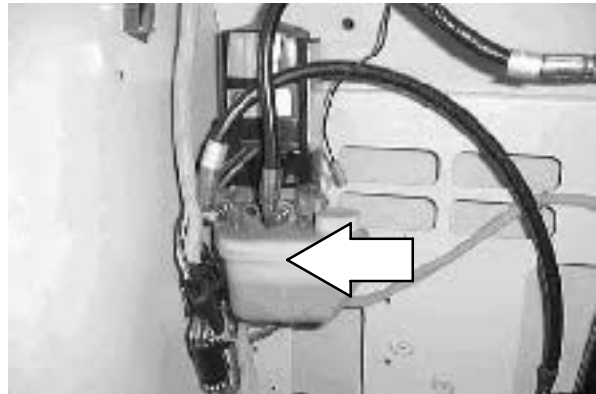

 **WARNING: Raised hopper may fall. Engage hopper support bar.**

 **WARNING: Lift arm pinch point. Stay clear of hopper lift arms.**

HYDRAULIC FLUID

The quality and condition of the hydraulic fluid play a very important role in how well the machine operates. Tennant's hydraulic fluid is specially selected to meet the needs of Tennant machines.

Tennant's hydraulic fluids provide a longer life for the hydraulic components. There are two fluids available for different temperature ranges:

TennantTrue premium hydraulic fluid (Extended Life)			
Part number	Ambient temperature	ISO Grade	Ca-pacity
1057710	above 7° C (45° F)	100	3.8 L (1 gal)
1057711	above 7° C (45° F)	100	19 L (5 gal)
1057707	below 7° C (45° F)	32	3.8 L (1 gal)
1057708	below 7° C (45° F)	32	19 L (5 gal)

The higher temperature fluid has a higher viscosity and should not be used at the lower temperatures. Damage to the hydraulic pumps may occur because of improper lubrication.

The lower temperature fluid is a thinner fluid for colder temperatures. This fluid should be used for the hydraulic lift cylinder at all times.

If a locally available hydraulic fluid is used, make sure the specifications match Tennant hydraulic fluid specifications. Using substitute fluids can cause premature failure of hydraulic components.

ATTENTION! Hydraulic components depend on system hydraulic fluid for internal lubrication. Malfunctions, accelerated wear, and damage will result if dirt or other contaminants enter the hydraulic system.

HYDRAULIC HOSES

Check the hydraulic hoses after every 800 hours of operation for wear or damage.

Fluid escaping at high pressure from a very small hole can be almost invisible, and can cause serious injuries.

See a doctor at once if injury results from escaping hydraulic fluid. Serious infection or reaction can develop if proper medical treatment is not given immediately.

FOR SAFETY: When servicing machine, use cardboard to locate leaking hydraulic fluid under pressure.

If you discover a fluid leak, contact your mechanic or supervisor.

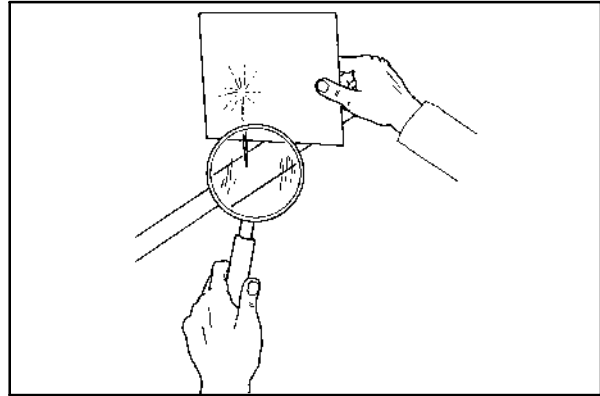

00002

ENGINE

Maintaining cooling system efficiency is important. Engine temperatures must be brought up to and maintained within the satisfactory range for efficient operation. However, the engine must be kept from overheating in order to prevent damage to the valves, pistons, and bearings. Check the air intake and cooling areas for debris daily, clean if necessary.

Clean the intake screen, shrouds and external surfaces after every 100 hours of operation.

FOR SAFETY: When servicing machine, wear eye and ear protection if using pressurized air or water.

AIR FILTER

The engine air filter is made up of two parts, an outer precleaner element and an inner air filter element. The precleaner element must be cleaned and re-oiled after every 25 hours of operation. The air filter element should be replaced after every 100 hours of operation. The air filter element must be replaced if it is damaged.

To clean the precleaner element, remove the air filter cover. Remove the precleaner element, wash in liquid detergent and water, and squeeze it dry in a cloth. After cleaning the precleaner element, inspect it for damage.



MAINTENANCE

Oil the precleaner element with 30cc (1oz) of clean engine oil. Squeeze the precleaner element to distribute the oil evenly throughout the foam.

Remove the air filter element. Carefully clean the covers and the interior of the housing with a damp cloth. Clean the housing sealing surfaces. Inspect the inner air filter element for damage. The slightest rupture requires replacement of the element. Inspect the seals on the ends of the element. They should be flexible and undamaged.



FUEL LINES

Check the fuel lines every 50 hours of operation. If any band clamps are loose, apply oil to the screw of the band, and securely tighten the band.

Made of rubber, the fuel lines may become worn out whether the engine has been used much or not. Replace the fuel lines and hose clamps every two years.

FOR SAFETY: When servicing machine, keep flames and sparks away from fuel system service area. Keep area well ventilated

If the fuel lines and hose clamps are found worn or damaged before two years' time, replace or repair them at once. Bleed the fuel system after replacement of any fuel lines. When the fuel lines are not installed, plug both ends with clean cloth or paper to prevent dirt from entering the lines.

There is a fuel valve located under the gasoline tank. This valve can be used to shut off the fuel flow if the fuel lines need to be serviced.

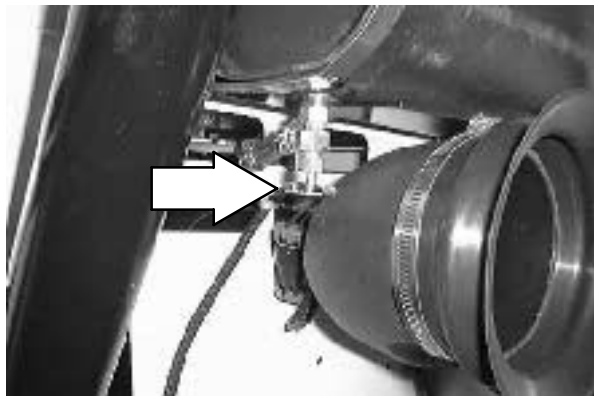
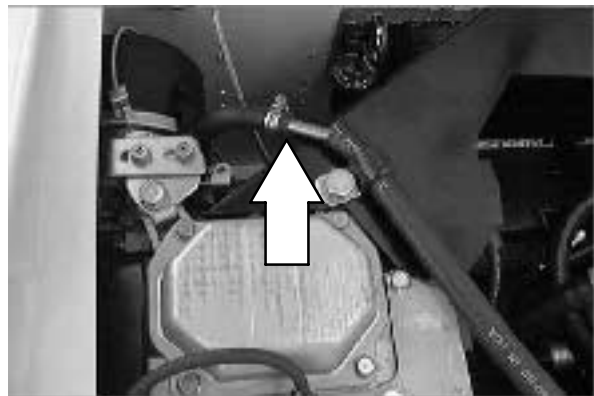

CARBURETOR

The carburetor is designed to deliver the correct fuel-to-air mixture to the engine under all operating conditions. The high idle is set at the factory and cannot be adjusted. The low idle fuel adjusting needle is also set at the factory and normally does not need adjustment.

If the engine is hard-starting, hard starting or stalls at low idle speed, it may be necessary to adjust or service the carburetor.

SPARK PLUGS

Clean or replace and set the gap of the spark plugs after every 100 hours of operation.

The proper spark plug gap is 0.6 mm (0.024 in).

BATTERY

The battery for the machine is a low maintenance battery. Do not add water to the battery, or remove the battery vent plugs.

The battery is located in the engine compartment.

After the first 50 hours of operation, and after every 800 hours after that, clean and tighten the battery connections.

FOR SAFETY: When servicing machine, avoid contact with battery acid.

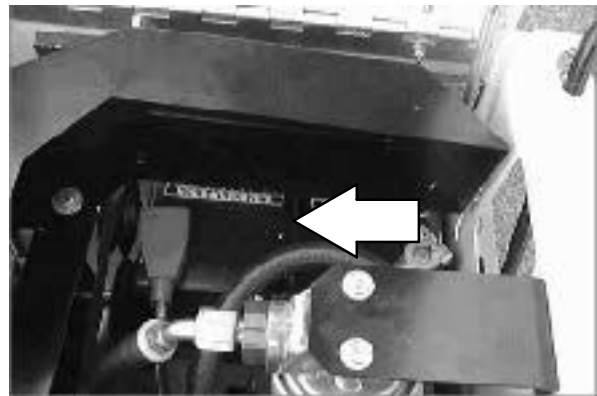

BELTS AND CHAINS

VACUUM FAN BELT

The vacuum fan belt drives the vacuum system. Check the belt for wear and tension after every 100 hours of operation.

The correct tension is when the belt deflects 13.0 mm (0.50 in) from a force of 17 kg (38 lb) at belt midpoint.

FOR SAFETY : When servicing machine, avoid moving parts. Do not wear loose jackets, shirts or sleeves when working on machine.

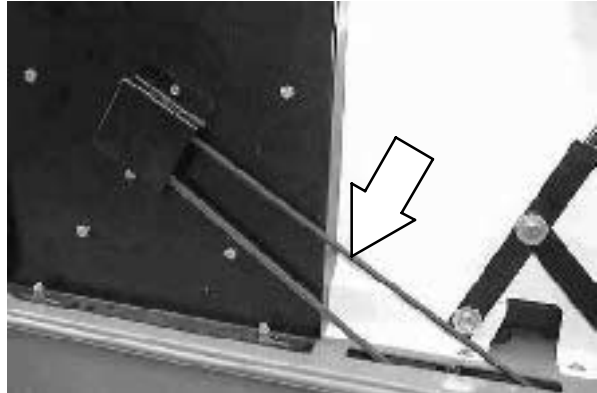

MAIN BRUSH BELT

The main brush belt drives the main brush. Check the main brush belt for wear and tension after every 100 hours of operation.

Set the tension with the top sheave. The correct tension on the belt is when the top sheave is putting 6 kg (13.6 lb) of pressure on the main brush belt.

FOR SAFETY : When servicing machine, avoid moving parts. Do not wear loose jackets, shirts or sleeves when working on machine.

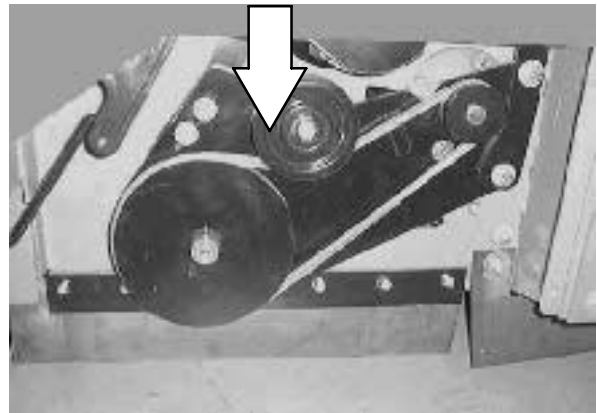

HYDRAULIC PUMP BELT

The hydraulic pump belt drives the hydraulic pump. Check the belt for tension and wear every 100 hours of operation.

The correct tension is when the belt deflects 4.0 mm (0.16 in) from a force of .45 kg (10.0 lb) at belt midpoint of the longest span.

FOR SAFETY : When servicing machine, avoid moving parts. Do not wear loose jackets, shirts or sleeves when working on machine.

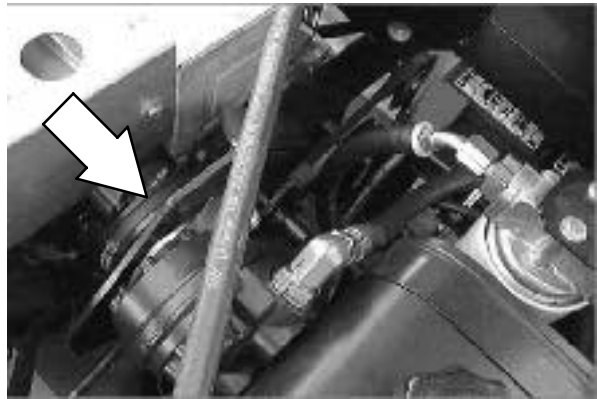

JACKSHAFT BELT

The jackshaft belt turns the jackshaft that drives the main brush and vacuum fan belts. Check the belt for tension and wear every 100 hours of operation.

The correct tension is when the belt deflects 6.0 mm (0.25 in) from a force of .45 kg (10.0 lb) at belt midpoint of the longest span.

FOR SAFETY : When servicing machine, avoid moving parts. Do not wear loose jackets, shirts or sleeves when working on machine.

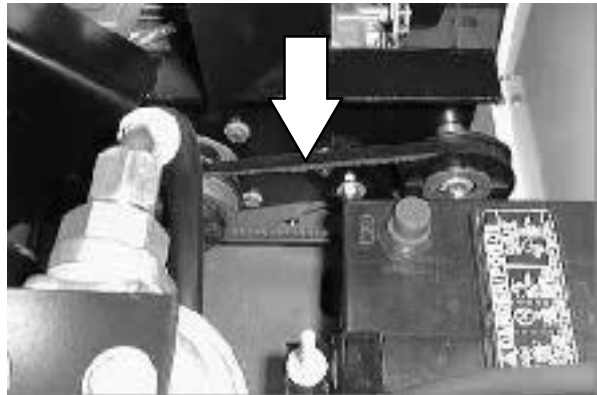

MAINTENANCE

STEERING GEAR CHAIN

The steering gear chain turns the front wheel as the steering wheel is turned to steer the machine. Lubricate the steering chain with 30 SAE engine oil after every 200 hours of operation. The chain does not need to be checked for tension.

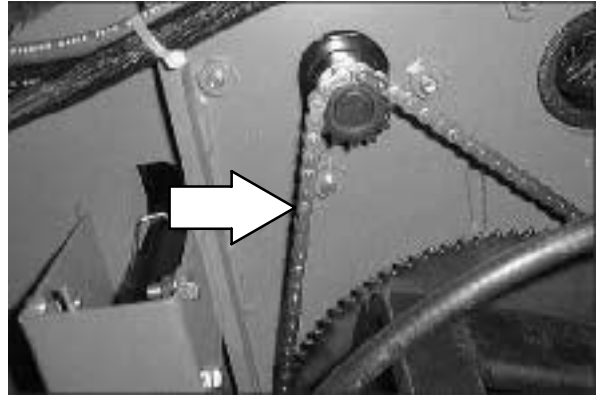

STATIC DRAG CHAIN

A static drag chain prevents the buildup of static electricity in the machine. The chain is attached to the machine by a rear main brush skirt retaining bolt.

Make sure the chain is touching the floor at all times.

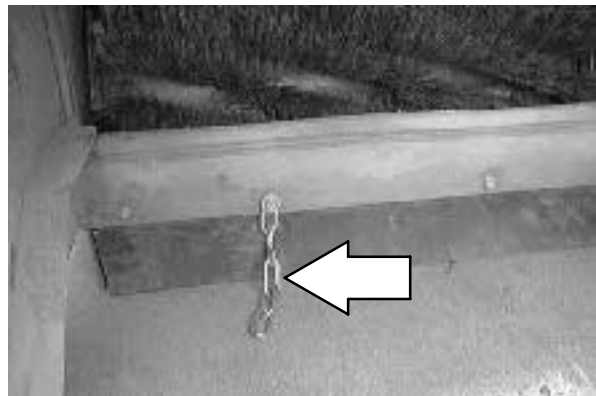

DEBRIS HOPPER

HOPPER DUST FILTER

The hopper filter filters the air pulled up from the hopper. The dust filter is equipped with a shaker to remove the accumulated dust particles. The dust filter shaker is operated by the main brush, vacuum and filter shaker switch.

Shake the dust filter before emptying the hopper and at the end of every work shift. Check and clean or replace the filter and filter seals after every 100 hours of operation.

To clean the dust filter, use one of the following methods:

- **SHAKING** - Press and hold the main brush, vacuum and filter shaker switch to the **Filter shaker** position.
- **TAPPING** - Remove the filter and tap the filter gently on a flat surface with the dirty side down. Do not damage the edges of the filter element and seals, or the filter will not seat properly in the filter frame.
- **AIR** - Always wear eye protection when using compressed air. Blow air through the dust filter opposite the direction of the arrows. Never use more than 690 kPa (100 psi) of air pressure and never closer than 50 mm (2 in) away from the filter. This may be done with the dust filter in the machine.

FOR SAFETY: When servicing machine, wear eye and ear protection if using pressurized air or water.



MAINTENANCE

REMOVING HOPPER DUST FILTER

1. Stop the machine, set the parking brake and turn the machine power off.

FOR SAFETY: Before leaving or servicing machine, stop on level surface, set parking brake, turn off machine, and remove key.

2. Unlatch and remove hopper cover.

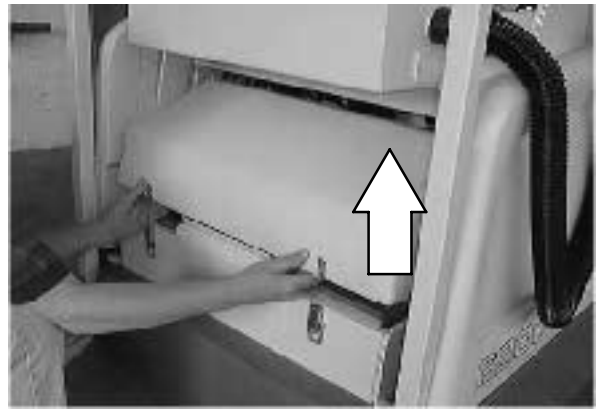

3. Unplug the filter shaker from the main harness.

Note: Carefully pull the wires apart from the bodies of the plugs Do not unplug the connections from the shaking mechanism. Do not pull on the wires. Damage could occur to the wires or the shaking mechanism.

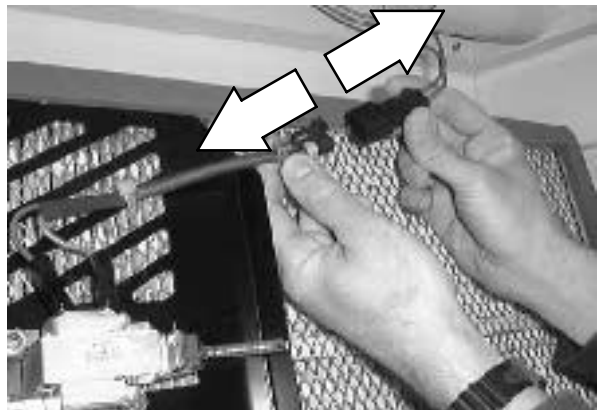

4. Lift dust filter assembly out of hopper.



5. Lift the VCS system filter shaker off of the filter.

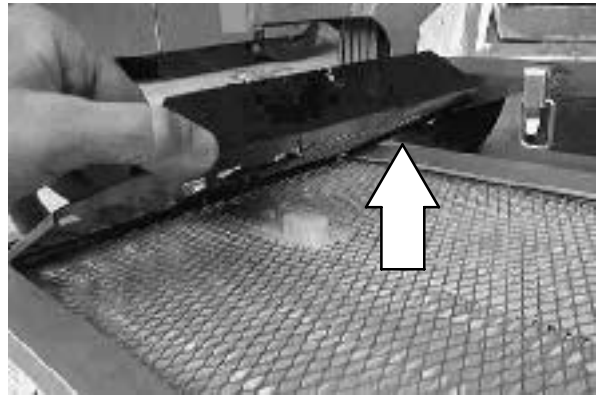

6. Clean or discard the Instant Access filter as required.

7. Replace the VCS system filter shaker. Use care to insert the shaking pin into the filter comb correctly.

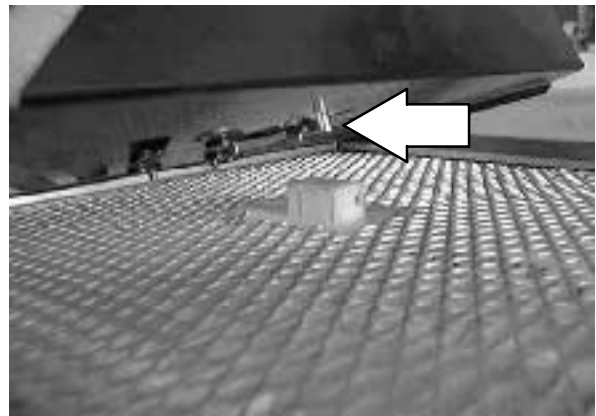

8. Place the edges of the shaker firmly between the filter and the filter seal.

NOTE: When installed properly, the shaker plate cannot move in either front-to-back or side-to-side directions. If the shaker is loose, it will not function properly.

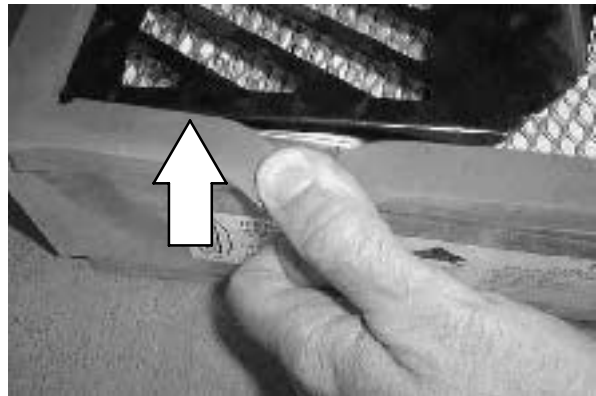

MAINTENANCE

9. The filter shaker should lay flat against the filter. Check to make sure the comb tab is not caught below the filter shaker plate.

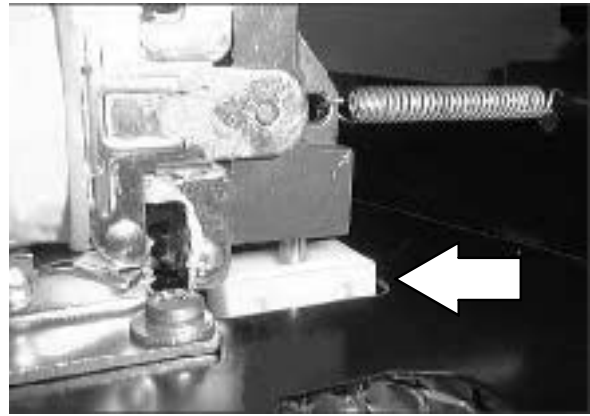

10. Check the shaker solenoid gap with the end of the shipping tab. The gap should be the same width as the tab. If it is not, loosen the mounting screws, adjust the gap by repositioning the shaker solenoid, then retighten the screws.



11. Return the filter back to the machine.



12. Reconnect the main harness to the shaker mechanism.

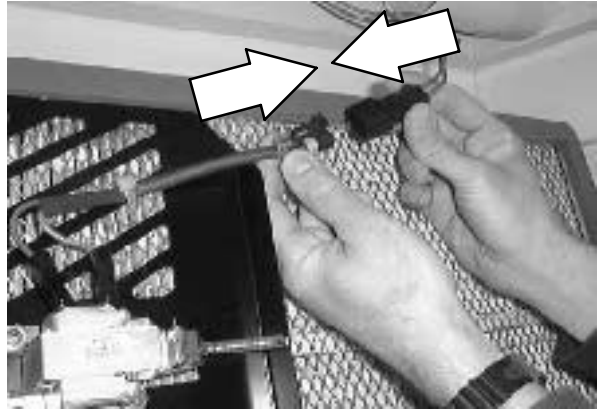

13. Check the dust filter seals.

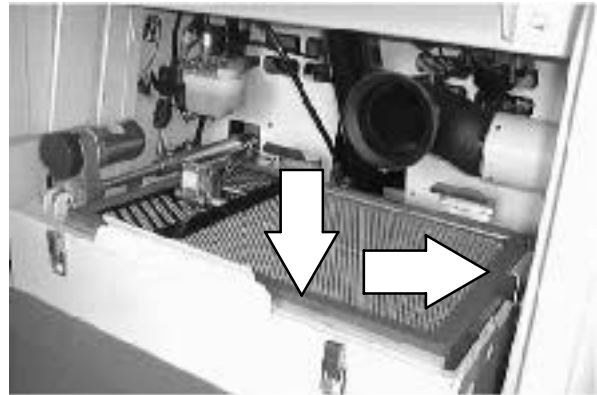

14. Replace hopper cover and secure with latches.

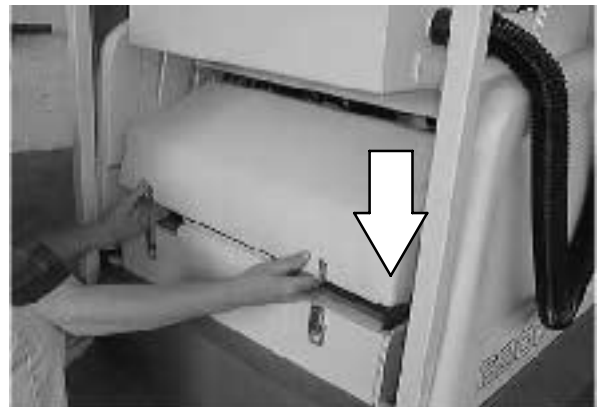

THERMO SENTRY

The Thermo Sentry is located above the debris hopper.

If a fire ignites in the hopper, the Thermo Sentry will close the vacuum fan damper. The damper will cut off air flow and help extinguish the fire. If this occurs, drive the machine to a safe location and eliminate the source of heat. Turn the machine off and back on to reset the Thermo Sentry.

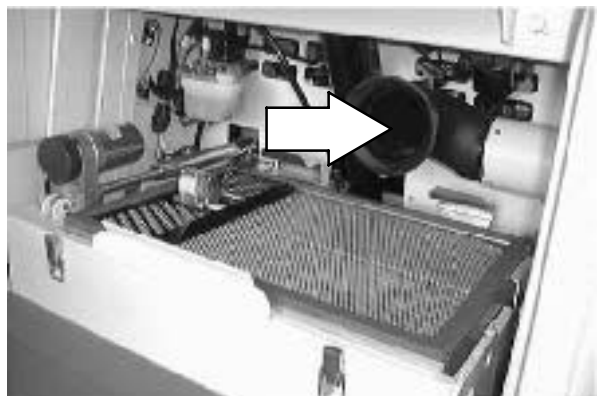

BRUSHES

MAIN BRUSH

The main brush is cylindrical and spans the width of the machine, sweeping debris into the hopper.

Check the brush daily for wear or damage. Remove any string or wire tangled on the main brush, main brush drive hub, or main brush idler hub.

Check the main brush pattern every 50 hours of operation. The pattern should be 50 to 75 mm (2 to 3 in) wide with the main brush in the lowered position.

Rotate the main brush end-for-end after every 50 hours of operation for maximum brush life and best sweeping performance.

Replace the main brush when it no longer cleans effectively.

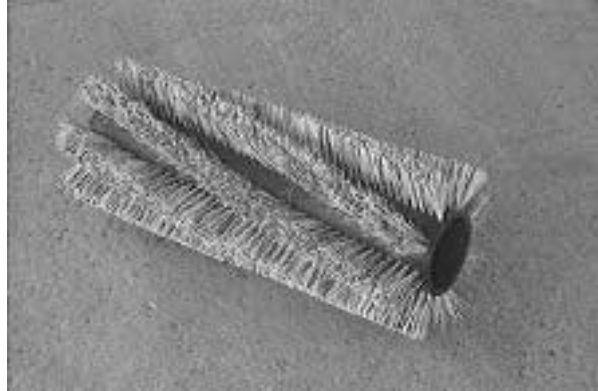

REPLACING MAIN BRUSH

1. Stop the machine, set the parking brake and turn the machine power off.

FOR SAFETY: Before leaving or servicing machine, stop on level surface, set parking brake, turn off machine, and remove key.

2. Open the left side main brush access door.

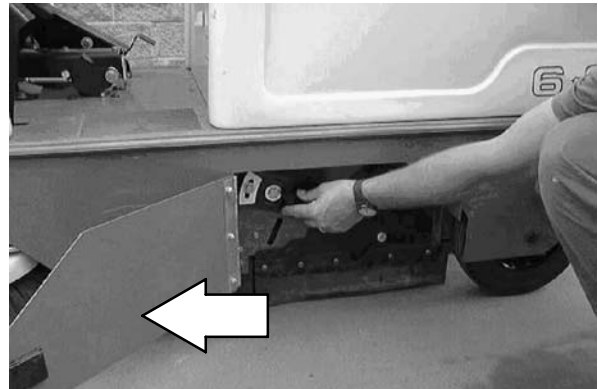

3. Loosen the idler arm mounting knob and three other side skirt mounting knobs. Remove the brush idler arm assembly.

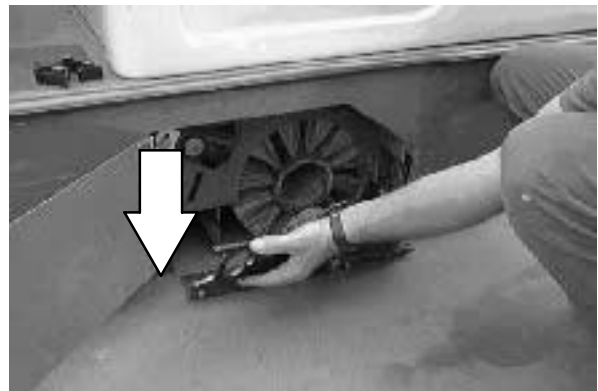

4. Grasp the main brush; pull it off the brush drive plug and out of the main brush compartment.
5. Put the new or rotated end-for-end main brush on the floor next to the access door.
6. Slide the main brush onto the drive plug. Rotate the brush until it engages the drive plug, and push it all the way onto the plug.



7. Check that the recirculation skirt is tucked in behind the frame.
8. Slide the main brush idler arm plug onto the main brush.

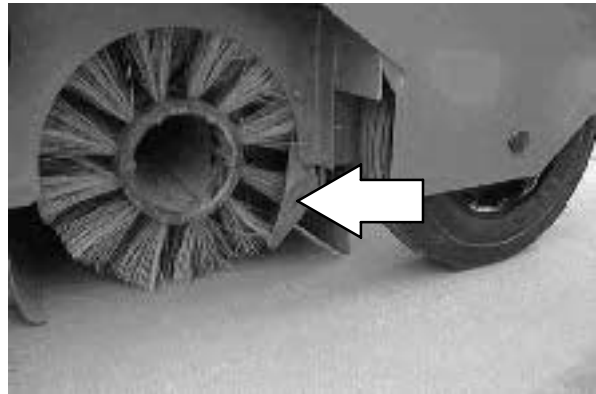

9. Secure the idler arm on the bolts. Hand tighten the mounting knobs.
10. Close the main brush access door.

CHECKING AND ADJUSTING MAIN BRUSH PATTERN

1. Apply chalk, or some other material that will not blow away easily, to a smooth, level floor.
2. Raise the side brush and main brush and position the main brush over the chalked area.
3. Start and lower the main brush for 15 to 20 seconds while keeping a foot on the brakes to keep the machine from moving.

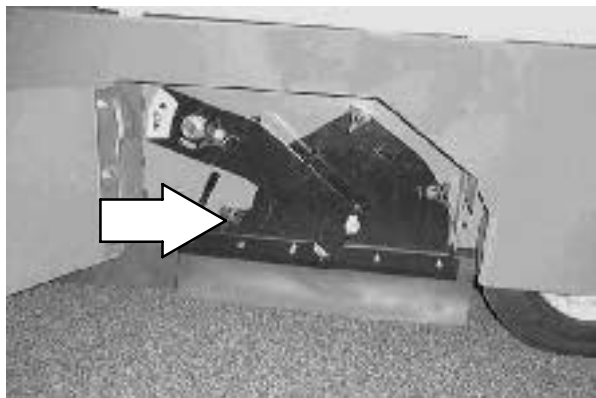

NOTE: If chalk or other material is not available, allow the brushes to spin on the floor for two minutes. A polish mark will remain on the floor.

4. Raise the main brush.
5. Drive the machine off the test area.

MAINTENANCE

6. Observe the width of the brush pattern. The proper brush pattern width is 50 to 75 mm (2 to 3 in).

The brush taper is factory set and should not need adjustment unless parts of the brush system have been replaced.

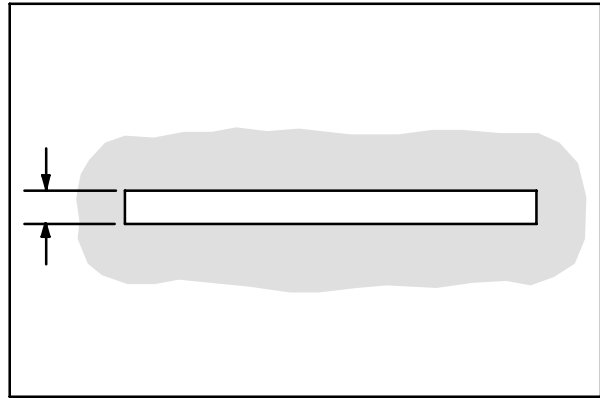

00582

If the main brush pattern is tapered, more than 15 mm (0.5 in) on one end than the other, adjust the taper as follows:

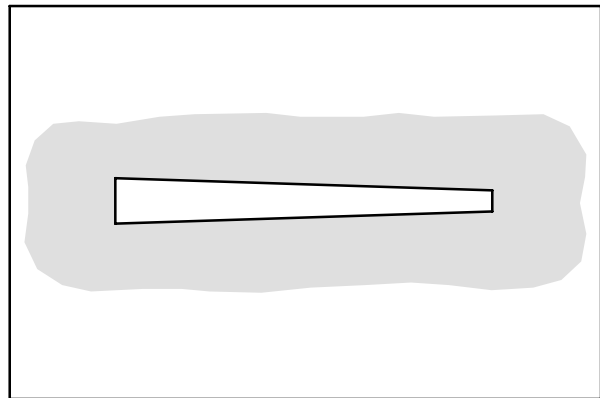

00601

1. Loosen the brush shaft bearing bracket mounting bolt and the idler arm securing head.
2. Allow the brush to operate and float into position for approximately 30 seconds.
3. Tighten the adjustment bolt and idler arm securing knob.
4. Check the main brush pattern and readjust as necessary.

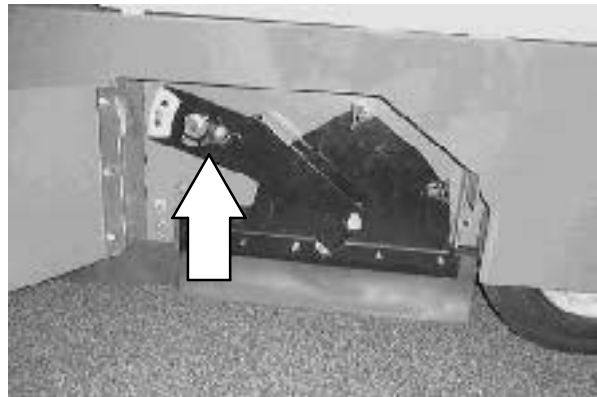

SIDE BRUSH

The side brush sweeps debris along edges into the path of the main brush.

Check the brush daily for wear or damage. Remove any string or wire found tangled on the side brush or side brush drive hub.

Check the side brush pattern daily. The side brush bristles should contact the floor in a 10 o'clock to 3 o'clock pattern when the brush is in motion.

Replace the brush(es) when it no longer cleans effectively.

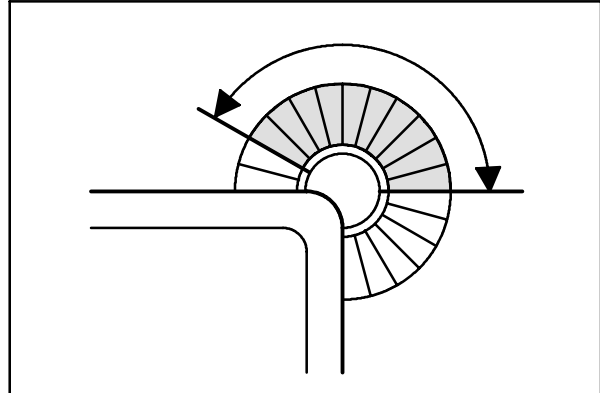

350327

Adjust the side brush pattern by loosening the hex screw located above the side brush pulley. Move the pulley mount bracket up or down to achieve the proper side brush pattern. Retighten the hex screw.

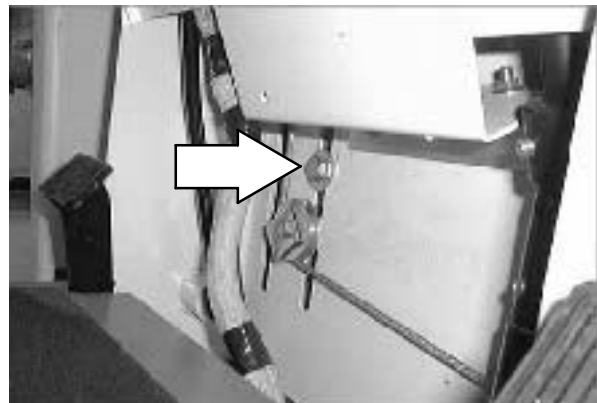

MAINTENANCE

REPLACING SIDE BRUSH

1. Stop the machine, set the parking brake and turn the machine power off.

FOR SAFETY: Before leaving or servicing machine, stop on level surface, set parking brake, turn off machine, and remove key.

2. Remove the side brush retaining pin from under the side brush drive shaft by pulling the pin keeper off over the end of the pin.
3. Slide the side brush off the side brush drive shaft.
4. Slide the new side brush onto the side brush drive shaft.
5. Insert the side brush retaining pin through the side brush hub and shaft.
6. Secure the pin by clipping the pin keeper over the end of the pin.



SIDE BRUSH GUARD

Check the side brush guard for damage or wear every 200 hours of operation. Replace the guard when it becomes worn.



SKIRTS AND SEALS

SIDE SKIRTS

The side skirts are located on both sides of the machine in front of the main brush compartment. The side skirts should clear the floor up to 5 mm (0.2 in).

Check the skirts for damage, wear and adjustment daily.

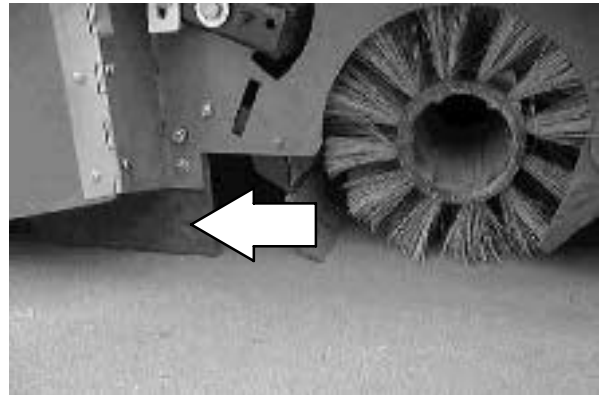

LARGE DEBRIS TRAP SKIRT

The large debris trap skirt is located along the front of the main brush. This skirt is raised and lowered by the large debris trap pedal, allowing larger debris to be trapped and swept up into the hopper.

Check the skirt for damage and wear daily.

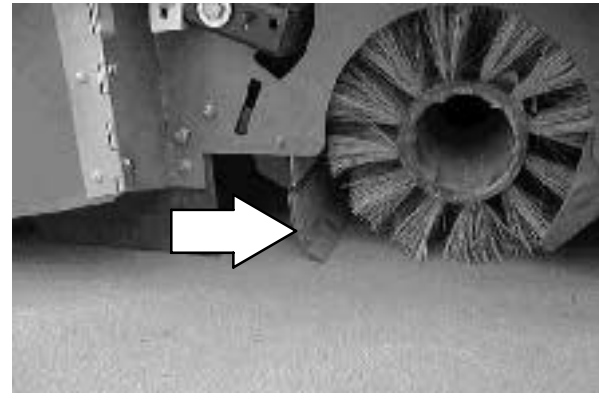

SIDE RECIRCULATION SKIRTS

The side recirculation skirts are located on both sides of the main brush compartment. The side recirculation skirts should clear the floor up to 5 mm (0.2 in).

Check the skirts for damage, wear and adjustment daily.

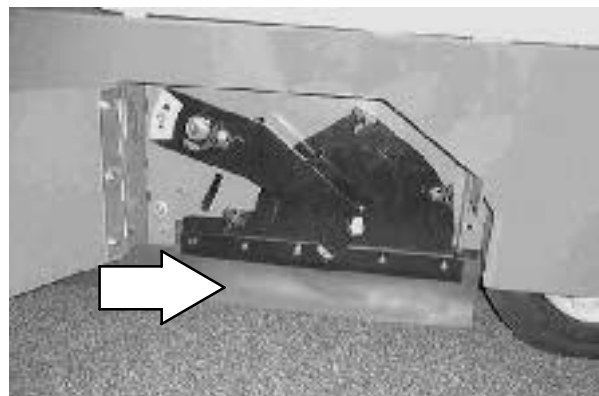

MAINTENANCE

REAR SKIRTS

The two rear skirts are located on the bottom rear of the main brush compartment. The vertical skirt should clear the floor up to 5 mm (0.25 in). The rear recirculation skirt requires no adjustment.

Check the skirts for damage, wear and adjustment daily.

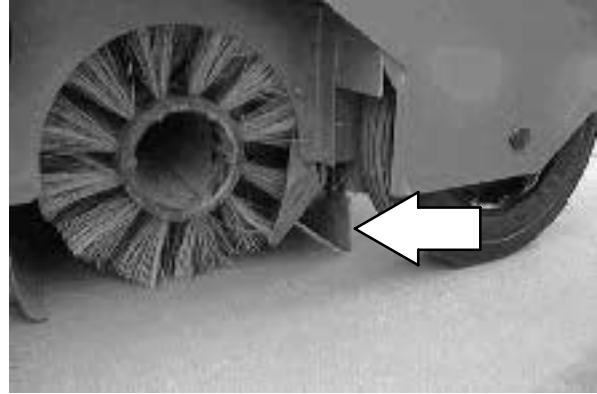

Note: The rear recirculation skirt must be folded in between the brush and the machine frame before the brush door is mounted for the machine to work properly.

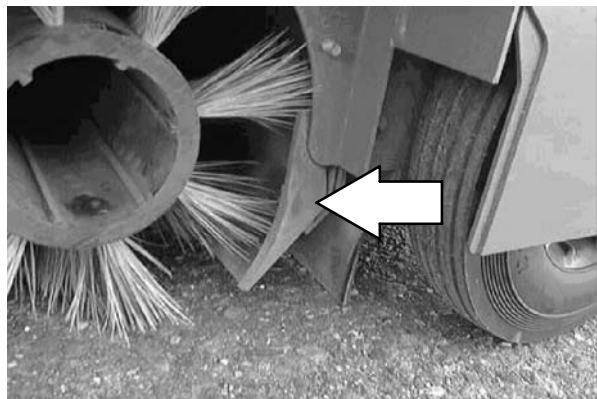
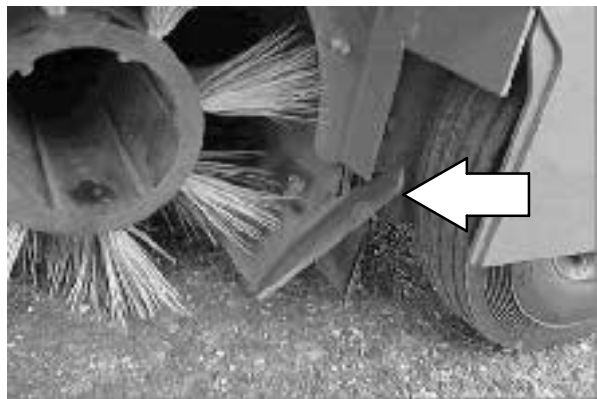

HOPPER SEALS

The hopper seals are located around the edge of the opening between the main brush and the hopper. The hopper rests against the seals when the hopper is in the closed position.

Check the seals for wear or damage after every 100 hours of operation.

 **WARNING: Raised hopper may fall. Engage hopper support bar.**

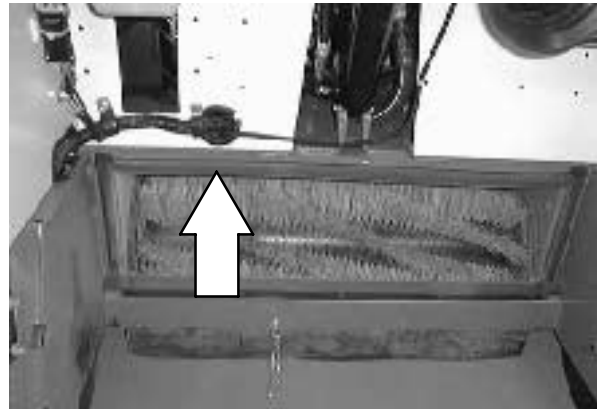

HOPPER DOOR SEAL

The hopper door seal is located on the bottom of the hopper and seals the hopper door when the hopper door is closed.

Check the seal for wear or damage after every 100 hours of operation.

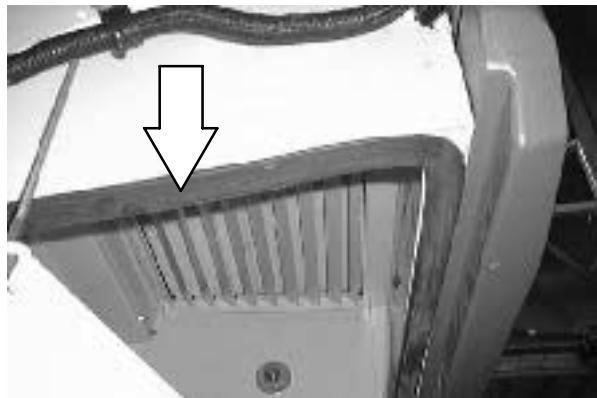

HOPPER LIP SEAL

The hopper lip seal is located on the inside of the rear lip of the hopper door and seals the inside lip of the hopper door with the hopper

Check the seal for wear or damage after every 100 hours of operation.



MAINTENANCE

VACUUM SEAL

The vacuum seal is located behind the debris hopper and seals with the hopper filter cover when the hopper is in the lowered position.

Check the seal for wear or damage after every 100 hours of operation.

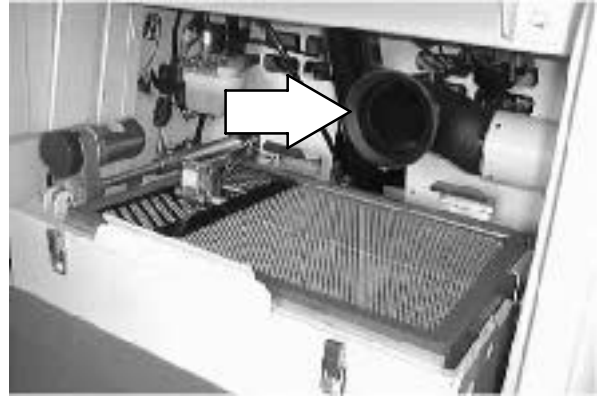

HOPPER FILTER SEALS

The hopper filter seals are located along the outside edge of the top and the bottom of the hopper filter. The hopper filter seals seal the hopper filter in between the hopper baffle plate and the hopper filter cover when the hopper filter cover is latched down in the proper operating position.

Check the seals for wear or damage after every 100 hours of operation.

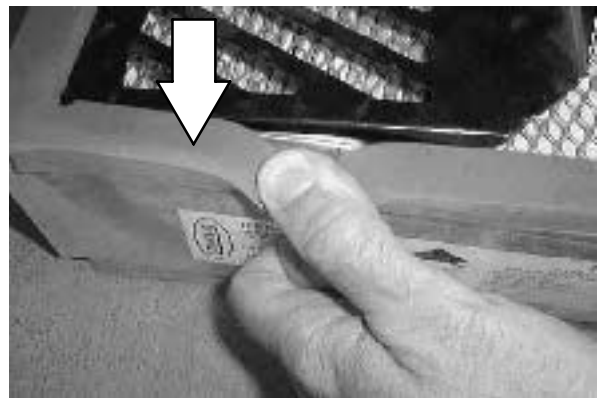

AIR INTAKE SEAL

The air intake seal is located along the outer edge of the air intake baffle and seals with the left side panel when the side panel is in place on the machine.

Check the seal for wear or damage after every 100 hours of operation.



BRAKES AND TIRES

BRAKES

The mechanical brake is located on the front wheel. The brake is operated by the brake foot pedal, connecting rods and cable.

Check the brake adjustment after every 200 hours of operation. If the brake does not respond well to pressure on the brake pedal, you may need to adjust the brake.

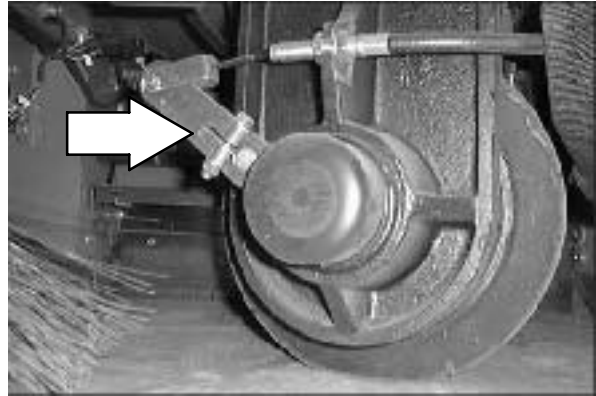

Adjust the brake cable tension with the cable nuts and the brake lever.

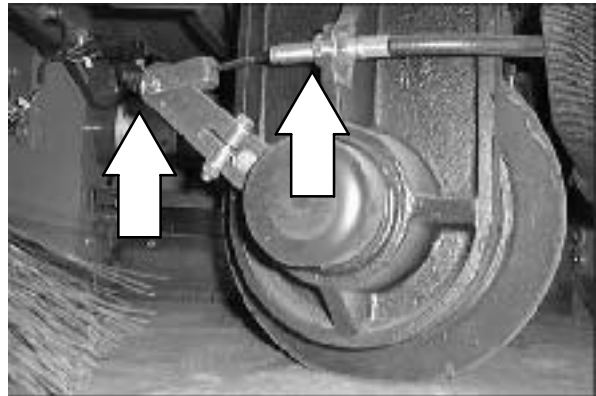

MAINTENANCE

TIRES

The tires on the machine are solid. Check the tires after every 100 hours of operation for damage or wear.

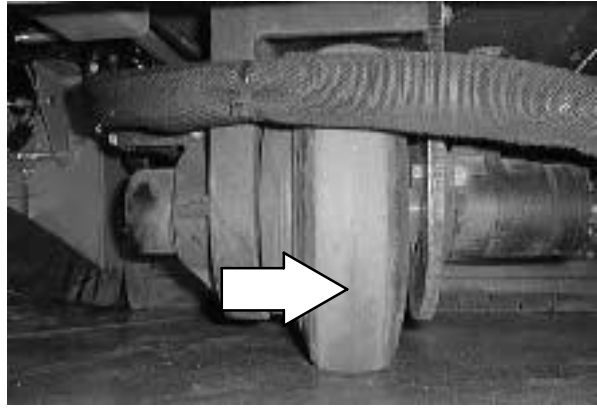

Check the torque on the rear wheel axles every 800 hours of operation. The proper torque on rear wheel axle is 22.4-28 Nm (16-20 ft lbs).

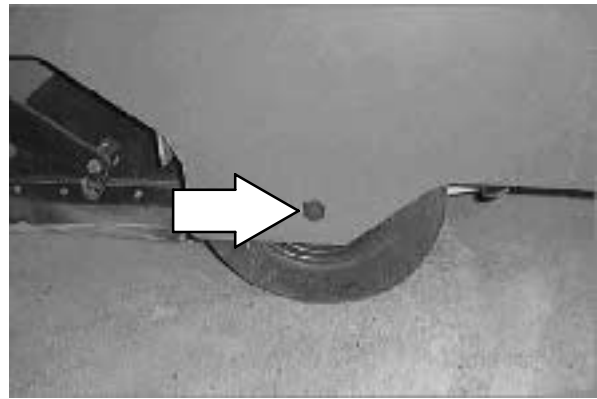

PUSHING, TOWING, AND TRANSPORTING THE MACHINE

PUSHING OR TOWING THE MACHINE

If the machine becomes disabled, it can be pushed or towed from the front or rear, but it is easier and more stable to tow from the front end.

Only push or tow the machine for a *very short distance* and do not exceed 1.6 kp/h (1 mph). It is NOT intended to be pushed or towed a long distance or at a high speed.

ATTENTION! Do not push or tow machine for a long distance or damage may occur to the propelling system.

TRANSPORTING THE MACHINE

1. Position the front of the machine at the loading edge of the truck or trailer.

FOR SAFETY: Use truck or trailer that will support the weight of the machine.

NOTE: Empty the hopper before transporting the machine.

2. If the loading surface is not horizontal or is higher than 380 mm (15 in) from the ground, use a winch to load machine.

If the loading surface is horizontal AND is 380 mm (15 in) or less from the ground, the machine may be driven onto the truck or trailer.



3. To winch the machine onto the truck or trailer, attach the winching chains to the front tie down located in the front of the machine frame.

FOR SAFETY: When loading machine onto truck or trailer, use winch. Do not drive the machine onto the truck or trailer unless the loading surface is horizontal AND is 380 mm (15 in) or less from the ground.

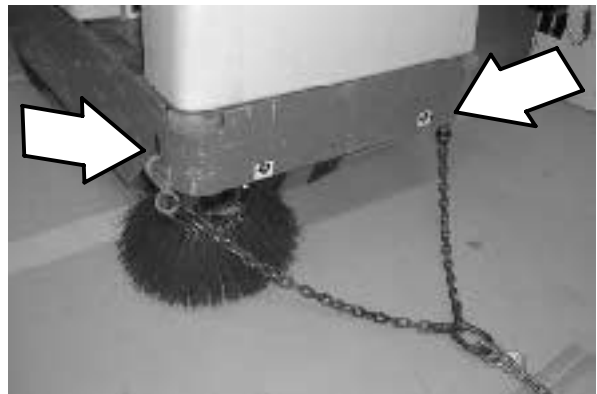

MAINTENANCE

4. Position the machine onto the truck or trailer as far as possible. If the machine starts to veer off the centerline of the truck or trailer, stop and turn the steering wheel to center the machine.
5. Set the parking brake and block the machine tires. Tie down the machine to the truck or trailer before transporting.

The front tie-down locations are the holes in the front of the machine frame.



The rear tie-down locations are the holes in the sides of the machine frame near the rear bumper.



6. If the loading surface is not horizontal or is higher than 380 mm (15 in) from the ground, use a winch to unload machine.

If the loading surface is horizontal AND is 380 mm (15 in) or less from the ground, the machine may be driven off the truck or trailer.

FOR SAFETY: When unloading machine off truck or trailer, use winch. Do not drive the machine off the truck or trailer unless the loading surface is horizontal AND 380 mm (15 in) or less from the ground.

MACHINE JACKING

Empty the hopper before jacking the machine. You can jack up the machine for service at the designated locations. Use a hoist or jack that will support the weight of the machine. Always stop the machine on a flat, level surface and block the tires before jacking up the machine.

FOR SAFETY: Before leaving or servicing machine, stop on level surface, set parking brake, turn off machine, and remove key.

The front jacking locations are on the flat bottom edge of the front of the machine frame.

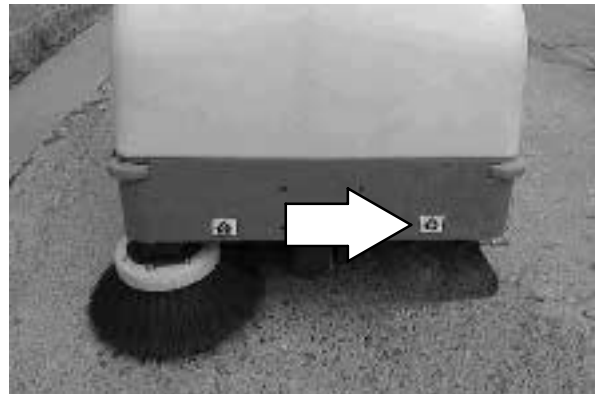

The rear jacking locations are on the corners of the rear frame.

FOR SAFETY: When servicing machine, block machine tires before jacking up machine.

FOR SAFETY: When servicing machine, jack up machine at designated locations only. Block machine up with jack stands.



STORING MACHINE

Before storing the machine for an extended time, the machine needs to be serviced to lessen the chance of rust, sludge, and other undesirable deposits from forming.

SPECIFICATIONS

SPECIFICATIONS

GENERAL MACHINE DIMENSIONS/CAPACITIES

Item	Dimension/capacity	
Length	1955 mm	(77 in)
Width	1070 mm	(43 in)
Width w/side brush	1117 mm	(44 in)
Height	1435 mm	(56.5 in)
Height with overhead guard	2045 mm	(80.5 in)
Track	94 mm	(37 in)
Wheelbase	97 mm	(38 in)
Main sweeping brush diameter	203 mm	(8 in)
Main sweeping brush length	710 mm	(28 in)
Side brush diameter	520 mm	(20.5 in)
Sweeping path width	710 mm	(28 in)
Sweeping path width with one side brush	1070 mm	(42 in)
Sweeping path width with two side brushes	1397 mm	(55 in)
Main sweeping brush pattern width	65 mm	(2.5 in)
Hopper weight capacity	135 kg	(300 lb)
Hopper volume capacity	125 L	(4.4 cu ft)
Dust filter area	4.5 sq m	(49 sq ft)
GVWR	620 kg	(1365 lb)
Ceiling height minimum dumping clearance	2286 mm	(90 in)
Vibration level at steering wheel does not exceed	2.5 m/s ²	
Vibration level at operator seat does not exceed	0.5 m/s ²	

GENERAL MACHINE PERFORMANCE

Item	Measure	
Maximum forward speed	8.0 km/h	(5 mph)
Maximum reverse speed	4.8 km/h	(3 mph)
Minimum aisle turn	2095 mm	(82.5 in)
Minimum turning radius, left	1400 mm	(55 in)
Minimum turning radius, right	1400 mm	(55 in)
Maximum rated incline with empty hopper	10°/18%	
Maximum rated incline with full hopper	6°/11%	

POWER TYPE

Engine	Type	Ignition	Cycle	Aspiration	Cylinders	Bore	Stroke
Robin	Piston	Breakerless-type spark	4	Natural	1	84 mm (3.31 in)	61 mm (2.40 in)
	Displacement		Net power, governed			Net power, maximum	
	338 cc (20.6 cu in)		5.0 kw (6.5 hp) @ 2500 rpm			8.0 kw (11 hp) @ 3600 rpm	
	Fuel		Cooling system			Electrical system	
	Gasoline, 87 octane minimum, unleaded. Fuel tank: 7.2 L (1.9 gal)		Air cooled			12 V nominal	
	LPG, Fuel tank: 9 kg (20 lb) Vapor					50 A alternator	
	Idle speed		(Fast) governed speed			Firing order	
	2500 rpm (gov)		2500 rpm (gov)			1	
	Spark plug gap		Valve clearance, cold			Engine lubricating oil	
0.6 mm (0.024 in) Gasoline and LPG		0.145 to 0.185 mm (0.0057 to 0.0072 in) intake and exhaust			1.20 L (1.3 qt) 10W30 SAE-SG/SH		

STEERING

Type	Power source	Emergency steering
Front wheel, manual controlled	Manual steering	Manual

HYDRAULIC SYSTEMS

System	Capacity	Fluid Type
Main hydraulic reservoir	7.58 L (2 gal)	ISO Grade 100 - above 7° C (45° F)
Main hydraulic total	9.48 L (2.5 gal)	
Hydraulic lift reservoir	0.53 L (.14 gal)	ISO Grade 32 - below 7° C (45° F)
Hydraulic lift total	1.4 L (.37 gal)	

BRAKING SYSTEM

Type	Operation
Service brakes	Mechanical disc brake (1), one front wheel, cable actuated
Parking brake	Utilizes service brakes, cable actuated

TIRES

Location	Type	Size
Front (1)	Solid	102 x 305 mm (4 in x12 in OD)
Rear (2)	Solid	90 x 305 mm (3.5 in x 12 in OD)

SPECIFICATIONS

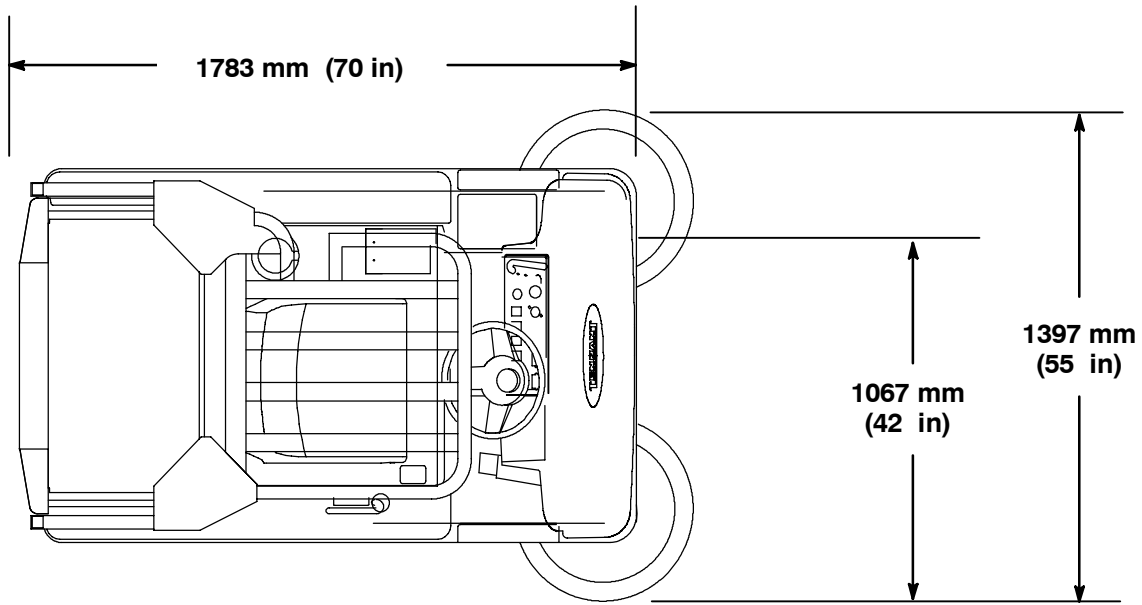

TOP VIEW

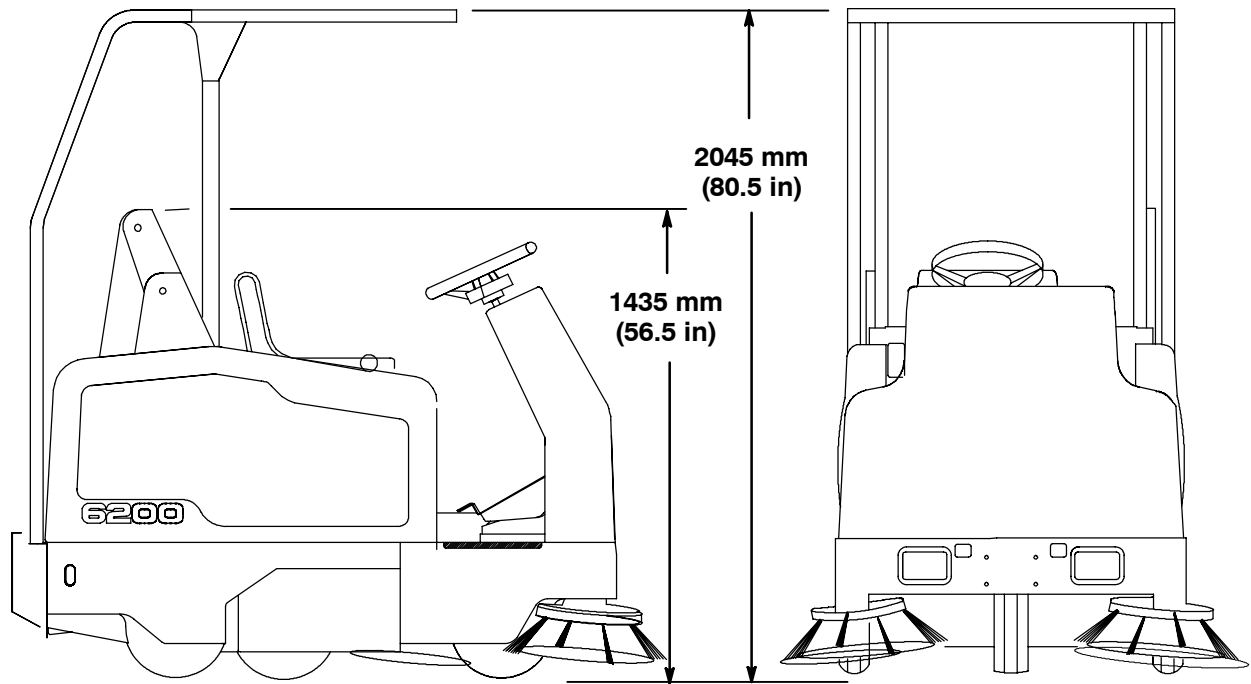

SIDE VIEW

FRONT VIEW

MACHINE DIMENSIONS

352945

A

Adjustable operator seat, 18
 Air filter, 47
 Filter element, 48
 Precleaner element, 47
 Air intake seal, 66
 Aisle turn, 72

B

Batteries
 Charger specifications, 73
 Specifications, 73
 Battery , 49
 Belts, 50
 Hydraulic pump, 51
 Jackshaft, 51
 Main brush, 50
 Vacuum Fan, 50
 Brake pedal, 10
 Brakes, 20, 32, 67
 System specifications, 73
 Brushes, 25–28, 58–63
 Adjusting main brush taper, 60
 Checking main brush pattern, 59–61
 Checking side brush pattern, 61
 Main brush, 25, 58–61
 Main brush bristle length, 58
 Main brush lever, 13
 Maintenance, 20, 32
 Pattern adjustment, 20, 32
 Rear skirts, 64
 Replacing main brush, 58–60
 Replacing side brush, 62
 Side brush, 26, 61–63
 Side brush bristle length, 61
 Side brush lever, 11
 Button, Horn, 11

C

Capacities, 72
 Carburetor, 49
 Chain, Steering gear, 42, 52
 Chains, 50
 Static drag, 52
 Changing LPG fuel tank, 21–23
 Charging system light, 13
 Choke knob, 14
 Circuit breakers, 17

Control panel, Hourmeter, 15
 Controls, 8
 Brake pedal, 10
 Charging system light, 13
 Choke knob (gasoline engine), 14
 Circuit breakers, 17
 Directional pedal, 9
 Fuel level gauge, 14
 Hopper door switch, 16
 Hopper Switch, 16
 Horn button, 11
 Hourmeter, 15
 Large debris trap pedal, 10
 Main brush lever, 13
 On-off key switch, 11
 Operating lights switch, 12
 Operating/hazard lights switch, 12
 Operation, 9
 Parking brake pedal, 10
 Side brush lever, 11
 Steering wheel, 15
 Symbols, 7–9
 Vacuum/filter shaker switch, 15

D

Debris hopper, 53–55
 Deluxe suspension seat, 18
 Dimensions, 72
 Directional pedal, 9
 Dust filter, Cleaning, 53

E

Electric motors, 73
 Electrical
 Circuit breakers, 17
 On-off key switch, 11
 Emptying the hopper, 29–32
 Engaging hopper support bar, 33
 Engine
 Air filter, 20, 32
 Fuel level, 20, 32
 Oil level, 20, 32
 Engine lubrication, 42

F

Filter , Air, 47
 Fuel level gauge, 14
 Fuel lines, 48
 Fuel tank, Changing LPG, 21–23

G

Gasoline engine choke knob, 14
Gauges, Fuel level, 14

H

Hopper
 Cleaning dust filter, 53
 Debris, 53–55
 Emptying the hopper, 29–32
 Switch, 16
Hopper , 19
 Door switch, 16
Hopper door seal, 65
Hopper door switch, 16
Hopper dust filter, 53
Hopper filter seals, 66
Hopper lip seal, 65
Hopper seals, 65
Hopper support bar, 33
 Disengaging, 35
 Engaging, 33
Hopper switch, 16
Horn button, 11
Hourmeter, 15
How the machine works, 20
Hydraulic fluid, 46
Hydraulic fluid reservoirs, 44
Hydraulic fluid strainer, 44
Hydraulic hopper lift reservoir, 45
Hydraulic hoses, 47
Hydraulic pump , Belt, 51
Hydraulic pump belt, 51
Hydraulic systems, 73
Hydraulics, 44–46, 47–49
 Fluid, 46–48
 Fluid filter, 45
 Fluid level, 20, 32, 44, 45
 Hoses, 47
 Reservoirs, 44

I

Indicators, Low oil warning indicator, 13
Instruments, Low oil warning indicator, 13
Intake screen, 47

J

Jack points, 71
Jacking up the machine, 71
Jackshaft, Belt, 51
Jackshaft belt, 51

L

Large debris trap pedal, 10
Large debris trap skirt, 63
Levers
 Main brush, 13
 Side brush, 11
Lights
 Charging system, 13
 Operating lights switch, 12
 Operating/hazard lights switch, 12
LPG, Changing the fuel tank, 21–23
Lubrication, 42–44
 Engine, 42
 Steering gear chain, 42
Lubrication , Steering castor pivot bearing, 43

M

Machine, Troubleshooting, 39
Machine components, 6
Machine dimensions, 74
Machine jacking, 71
Machine tie down location, 70
Main brush, 25, 58–61
 Adjust brush taper, 60
 Belt, 50
 Bristle length, 58
 Checking brush pattern, 59–61
 Maintenance, 58
 Rear skirts, 64
 Replacing, 58–60
Main brush belt, 50
Main brush lever, 13
Main hydraulic reservoir, 44
Maintenance, 40
 Axle torque, Rear wheel, 68
 Intervals, 40–42
Maintenance chart, 40–42
Motors, Electric, 73

O

Oil, low warning indicator, 13
 On-off key switch, 11
 Operating lights switch, 12
 Operating/hazard lights switch, 12
 Operation on inclines, 24
 Operator Responsibility, 5
 Operator Seat, 18
 Option, Deluxe suspension seat, Adjustment, 18
 Options
 Adjustable operator seat, 18
 Operating lights switch, 12
 Operating/hazard lights switch, 12
 QuickMop, 37

P

Parking brake pedal, 10
 Pedal, Directional, 9
 Pedals
 Brake, 10
 Large debris trap pedal, 10
 Parking brake, 10
 Post-operation checklist, 32
 Pre-operation checklist, 20
 Pushing machine, 69
 Pushing or towing the machine, 69

Q

QuickMop Option, 37

R

Rear skirts, 64
 Rear wheel axle torque, 68
 Recirculation skirt, Tucking in skirt, 64
 Removing hopper dust filter, 54

S

Operation, 5
 Hopper , 19
 QuickMop, 37
 Safety
 Labels, 4
 Precautions, 3–5

Seals, 63–66
 Air intake , 66
 Hopper, 65
 Hopper door, 65
 Hopper filter, 66
 Hopper lip, 65
 Vacuum, 66
 Seat
 Adjustable operator, 18
 Deluxe suspension, 18
 Operator, 18
 Service records, 20, 32
 Shrouds, 47
 Side brush, 26, 61–63
 Bristle length, 61
 Checking brush pattern, 61
 Lever, 11
 Replacing, 62
 Side brush guard, 62
 Side brush lever, 11
 Side recirculation skirts, 63
 Side skirts, 63
 Skirts, 63–66
 Large debris trap, Seals, 63
 Rear, 64
 Side, 63
 Side recirculation, 63
 Skirts and seals, 20, 32
 Spark plugs, 49
 Specifications, 72–75
 Braking system, 73
 Chargers, 73
 Electric motors, 73
 Machine capacities, 72
 Machine dimensions, 72
 Machine performance, 72
 Power type, 73
 Steering, 73
 Tires, 73
 Starting the machine, 23
 Static drag chain, 52
 Steering, 20, 32
 Specifications, 73
 Steering castor pivot bearing, 43
 Steering gear chain, 42, 52
 Steering wheel, 15
 Stop sweeping, 28
 Stop the machine, 31
 Storing machine, 71
 Sweeping, 26

Sweeping and brush information, 25–28

Switches

Hopper door, 16

Hopper switch, 16

On-off key, 11

Operating lights, 12

Operating/hazard lights, 12

Vacuum/filter shaker, 15

Systems, Hydraulic, 73

T

Thermo Sentry, 57

Tie down location, 70

Tires, 67, 68

Specifications, 73

Towing machine, 69

Transporting machine, 69

Transporting the machine, 69

Travel speed, 72

Troubleshooting, 39

V

Vacuum fan, Belt, 50

Vacuum fan belt, 50

Vacuum seal, 66

Vacuum/filter shaker switch, 15