

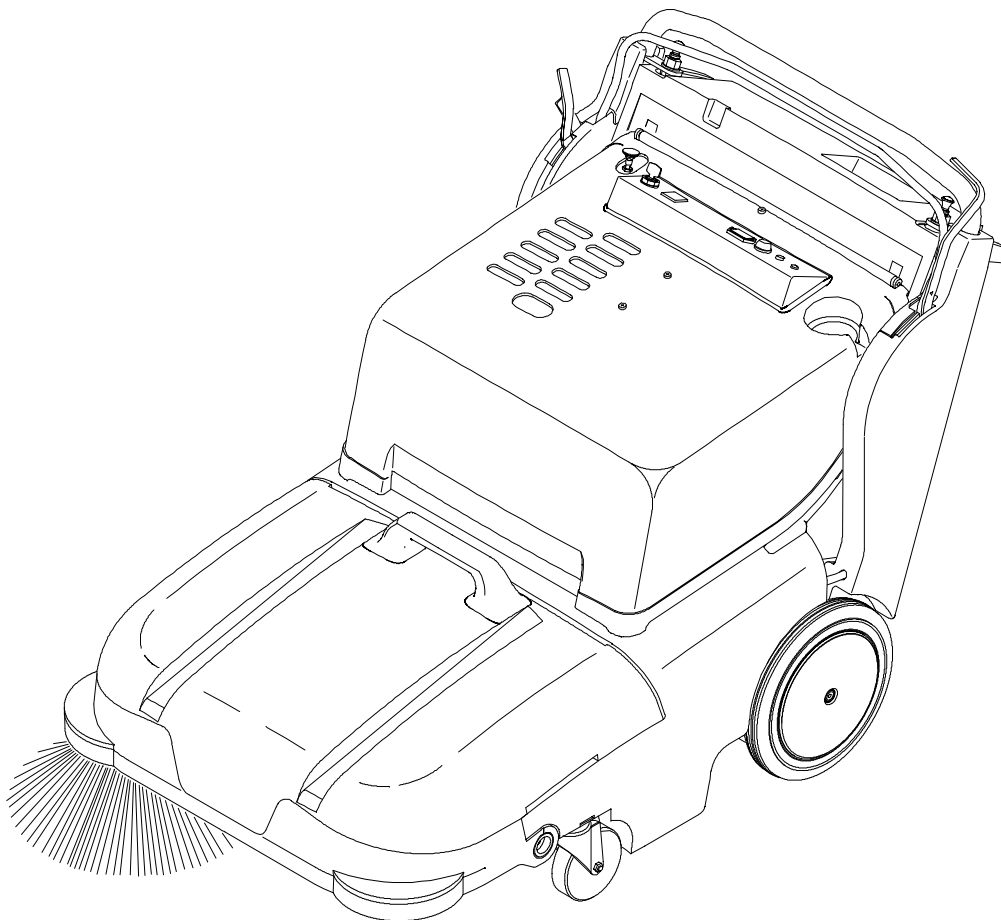

# 3640G/LP

## Service Manual



**330585**  
**Rev. 01 (12-01)**



This service manual is intended to be an aid for the disassembly and reassembly of your TENNANT Model 3640G/LP walk behind sweeper.

The set is organized into five major groups: General Information, Chassis, Sweeping, Electrical, and Engine G/LP.

**General Information:** Safety precautions, machine transport, machine jacking, machine storage, chassis lubrication, machine specifications, and machine maintenance chart.

**Chassis:** Tire/wheel replacement, caster replacement, and transaxle repair.

**Sweeping:** Hopper repair/replacement, brush repair/replacement, skirt/seal repair/replacement, and sweeping troubleshooting.

**Electrical:** Battery maintenance and replacement, electrical schematics, and electrical troubleshooting.

**Engine - GAS/LP:** Air filter replacement, oil changing, engine repair, engine troubleshooting, engine removal, fuel system repair, and engine repairs.

Manual Number - 330585

Revision: 01

Published: 12-01



**CALIFORNIA PROPOSITION 65 WARNING:**

**Engine exhaust from this product contains chemicals known to the State of California to cause cancer, birth defects, or other reproductive harm.**

**CONTENTS**

	Page
SAFETY PRECAUTIONS .....	1-3
SPECIFICATIONS .....	1-5
GENERAL MACHINE	
DIMENSIONS/CAPACITIES .....	1-5
GENERAL MACHINE PERFORMANCE .	1-5
POWER TYPE .....	1-6
ELECTRIC MOTORS .....	1-6
TIRES .....	1-6
MACHINE DIMENSIONS .....	1-7
MAINTENANCE .....	1-8
MAINTENANCE CHART .....	1-8
PUSHING AND TRANSPORTING THE	
MACHINE .....	1-9
PUSHING THE MACHINE .....	1-9
TRANSPORTING THE MACHINE ...	1-9
MACHINE STORAGE .....	1-11
STATIC DRAG CHAIN .....	1-13
HARDWARE INFORMATION .....	1-14
STANDARD BOLT TORQUE CHART ..	1-14
METRIC BOLT TORQUE CHART .....	1-14
BOLT IDENTIFICATION .....	1-14
THREAD SEALANT AND LOCKING	
COMPOUNDS .....	1-14



## SAFETY PRECAUTIONS

The following symbols are used throughout this manual as indicated in their description:



**WARNING:** To warn of hazards or unsafe practices that could result in severe personal injury or death.

**FOR SAFETY:** To identify actions that must be followed for safe operation of equipment.

The machine is suited to sweep disposable debris. Do not use the machine other than described in this Operator Manual. The machine is not designed for use on public roads.

The following information signals potentially dangerous conditions to the operator or equipment:

**FOR SAFETY:**

1. **Do not operate machine:**
  - Unless trained and authorized.
  - Unless operation manual is read and understood.
  - In flammable or explosive areas unless designed for use in those areas.
2. **Before starting machine:**
  - Check for fuel leaks.
  - Keep sparks and open flame away from refueling area.
  - Make sure all safety devices are in place and operate properly.
3. **When using machine:**
  - Go slowly on inclines and slippery surfaces.
  - Use care when reversing machine.
  - Do not carry riders on machine.
  - Always follow safety and traffic rules.
  - Report machine damage or faulty operation immediately.
4. **Before leaving or servicing machine:**
  - Stop on level surface.
  - Move directional lever into Park position.
  - Turn off machine and remove key.

5. **When servicing machine:**
  - Avoid moving parts. Do not wear loose jackets, shirts, or sleeves when working on machine.
  - Use hoist or jack that will support the weight of the machine.
  - Wear eye and ear protection if using pressurized air or water.
  - Disconnect battery connections before working on machine.
  - Keep flames and sparks away from fuel system service area. Keep area well ventilated.
  - Avoid contact with battery acid.
  - Use Tennant supplied or equivalent replacement parts.
6. **When loading/unloading machine onto/off truck or trailer:**
  - Turn off machine.
  - Use truck or trailer that will support the weight of the machine.
  - Use winch. Do not push the machine onto/off the truck or trailer unless the load height is 380 mm (15 in) or less from the ground.
  - Block machine tires.
  - Tie machine down to truck or trailer.



**WARNING:** Heavy hopper. Get help to handle.



**WARNING:** Brush throws debris. Stop motor before lifting hopper.



**WARNING:** Moving belt and fan. Keep away.



**WARNING:** Engine emits toxic gases. Severe respiratory damage or asphyxiation can result. Provide adequate ventilation. Consult with your regulatory agency for exposure limits. Keep engine properly tuned.

## GENERAL INFORMATION

The following safety labels are mounted on the machine in the locations indicated. If these or any labels become damaged or illegible, install a new label in its place.

**FOR SAFETY LABEL - LOCATED ON THE CONTROL PANEL**

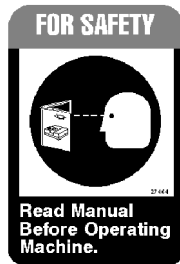

**TOXIC GASES LABEL - LOCATED ON THE CONTROL PANEL**



**BACK STRAIN LABEL - LOCATED ON THE MOTOR COMPARTMENT COVER**

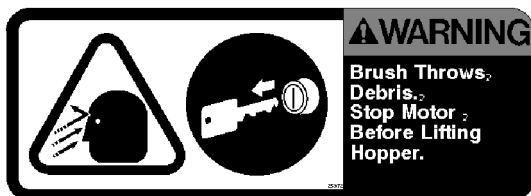

**FLYING DEBRIS WARNING LABEL - LOCATED ON THE MOTOR COMPARTMENT COVER**

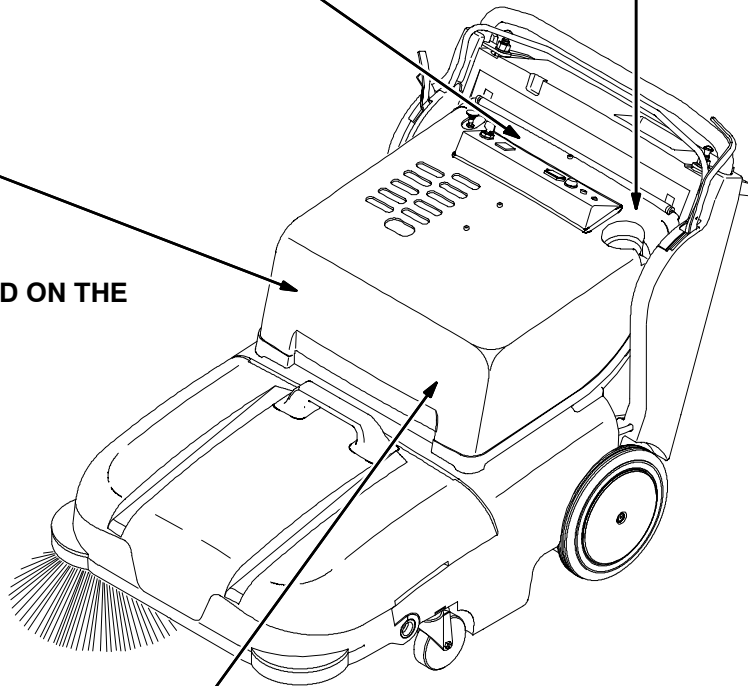

350841

**SPECIFICATIONS**

**GENERAL MACHINE DIMENSIONS/CAPACITIES**

Item	Dimension/capacity
Length (Low / High steering bar position)	1428 / 1475 mm (56.25 / 58 in)
Width	820 mm (32.25 in)
Height (Low / High steering bar position)	880 / 960 mm (34.7 / 37.7 in)
GVWR - Gasoline engine	206 kg (455 lb)
GVWR - LPG engine	220 kg (485 lb)
Track	775 mm (30.50 in)
Wheelbase	490 mm (19.36 in)
Main brush diameter	205 mm (8 in)
Main brush length	610 mm (24 in)
Side brush diameter	420 mm (16.5 in)
Sweeping path width, main brush only	610 mm (24 in)
Sweeping path width, main brush and one side brush	815 mm (32 in)
Sweeping path width, main brush and two side brushes	1015 mm (40 in)
Hopper capacity - Maximum	85 L (3.0 cu ft)
Hopper capacity - Usable	42.5 L (1.5 cu ft)
Panel filter area	3.62 sq m (39 sq ft)
Bag filter volume	17 L (0.6 cu ft)

**GENERAL MACHINE PERFORMANCE**

Item	Measure
Maximum forward speed - first speed	1.5 kmh (0.9 mph)
Maximum forward speed - second speed	2.7 kmh (1.7 mph)
Maximum forward speed - third speed	5.0 kmh (3.1 mph)
Maximum reverse speed	2.2 kmh (1.4 mph)
Minimum steering diameter	1588 mm (62.5 in)
Minimum turning radius	794 mm (31.25 in)
Maximum rated climb and descent angle	8°
Fuel consumption - Gasoline engine	0.75 L/hr (0.2 gal/hr)
Fuel consumption - LPG engine	0.4 kg/hr (0.9 lb/hr)

## GENERAL INFORMATION

### POWER TYPE

Engine	Type	Ignition	Cycle	Aspiration	Cylinders	Bore	Stroke	
	OHV	Gas - magneto	4	Natural	1	67 mm (2.14 in)	49 mm (1.93 in)	
		LPG - Solid State						
	Displacement		Net power, governed		Net power, maximum			
	172 cc (10.5 cu in)		3.6 hp @ 2400 rpm		6 hp @ 4000 rpm			
	Fuel		Cooling system		Electrical system			
	Automotive regular gasoline, 87 octane minimum, unleaded. Fuel tank: 3.6L (0.95 gal)		Air		Alternator output 13.5 V / 9.6A @ 2400 rpm			
	LPG, (vapor) Fuel tank: 9 kg (20 lb)				12 V Battery- 260 cca			
	Governed speed, under load							
	2400 rpm maximum							
	Engine lubricating oil with filter							
	0.65L (1.4 pt) 30 SAE-CD/SE rated engine oil							

### ELECTRIC MOTORS

Type	Use	VDC / Amp	Kw (hp)
Electric Motors	Side brush(es) (disk)	13 V / 4.25 A	0.075 (.1)

### TIRES

Location	Type	Size
Front (2)	Casters	35 mm wide x 127 mm OD (1.375 in wide x 5 in OD)
Rear (2)	Solid	45 mm wide x 305 mm OD (1.75 in wide x 12 in OD)



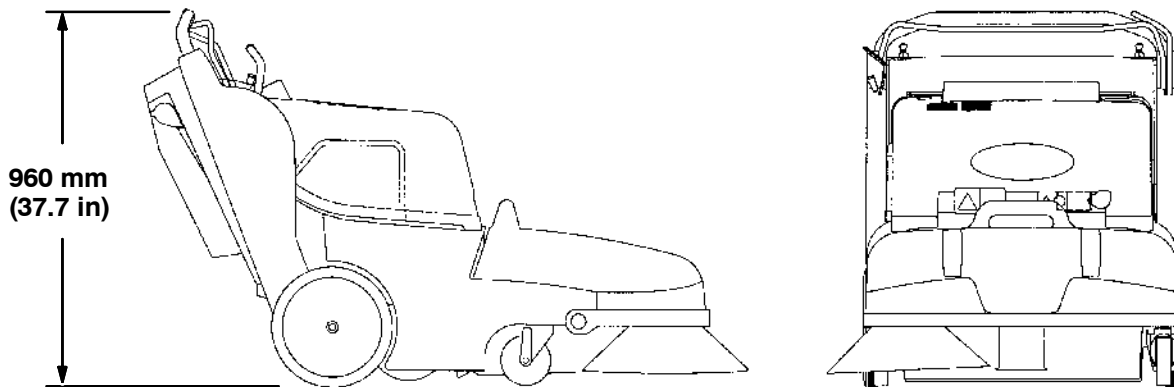
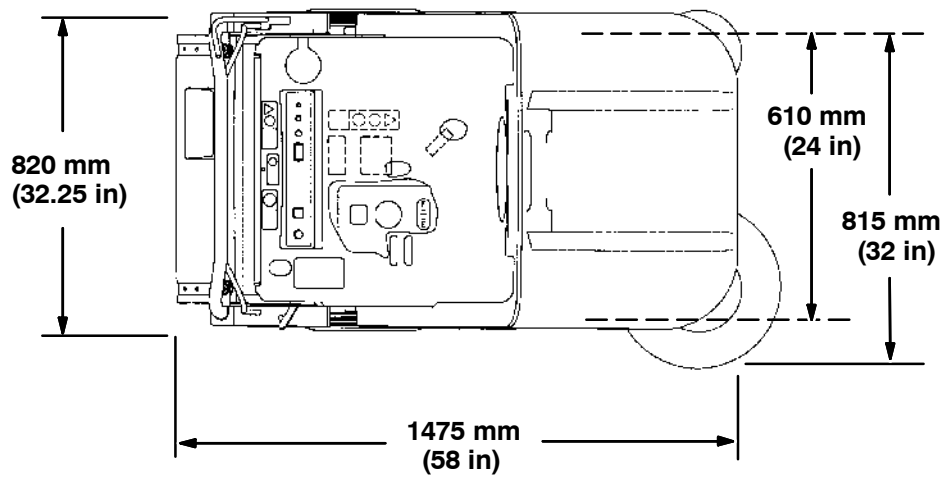

MACHINE DIMENSIONS

350910

**MAINTENANCE**

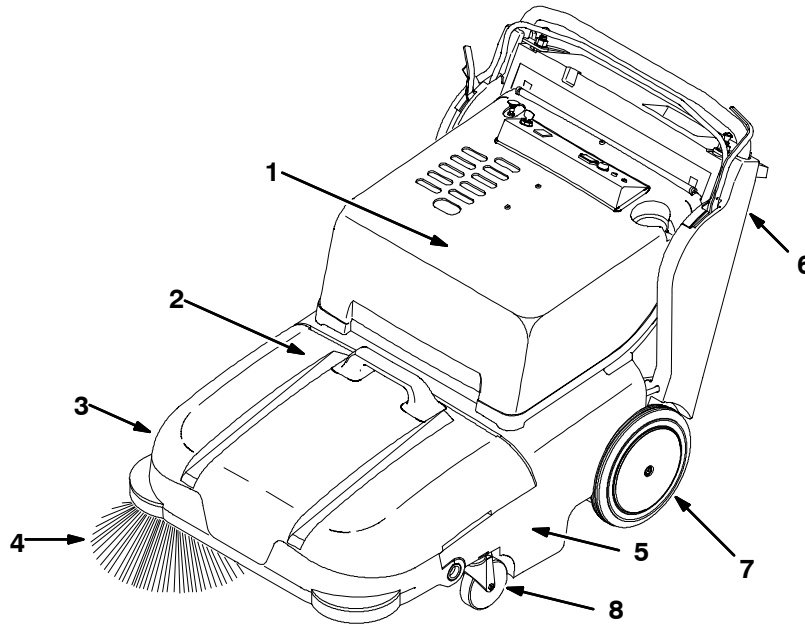

350841

**MAINTENANCE CHART**

Interval	Key	Description	Procedure	Lubricant/ Fluid	No. of Service Points
Daily	1	Engine oil	Check with dipstick	EO	1
	4,5	Main brush and side brush(es)	Check for damage and wear	-	2 (3)
	2	Skirts and seals	Inspect	-	6
	6	Bag filter (option)	Check / replace if full	-	1
	6	Panel filter	Shake filter, clean compartment door	-	1
	2	Vacuum inlet plate	Check / clean	-	1
50 Hours	1	Engine oil	Change	EO	1
	1	Engine air filter	Replace	-	1
	1	Vacuum fan belt	Check tension and wear	-	1
	5	Main brush	Rotate end for end and check brush pattern	-	1
100 Hours	6	Panel filter	Remove and clean	-	1
	7	Wide track tires (option)	Check for damage / pressure	-	2
	8	Heavy duty casters (option)	Lubricate	SPL	2
200 Hours	1	Sparkplug	Check / replace	-	1
	1	Gasoline fuel filter / sediment bowl	Clean	-	1
500 Hours	3	Side brush motor(s)	Check motor brushes	-	1 (2)

**LUBRICANT/FLUID**

EO . . . . Engine oil, 30 SAE - CD/SF rated

SPL . . . Special lubricant, Lubriplate EMB grease (TENNANT part no. 01433-1)

---

## PUSHING AND TRANSPORTING THE MACHINE

---

### PUSHING THE MACHINE

If the machine becomes disabled, it can be easily pushed in neutral if necessary.

### TRANSPORTING THE MACHINE

1. Position the front of the machine at the loading edge of the truck or trailer.

**FOR SAFETY: Use truck or trailer that will support the weight of the machine.**

*NOTE: Empty the hopper before transporting the machine.*

2. If the loading surface is not horizontal or is higher than 380 mm (15 in) from the ground, use a winch to load machine.

If the loading surface is horizontal AND is 380 mm (15 in) or less from the ground, the machine may be pushed onto the truck or trailer.

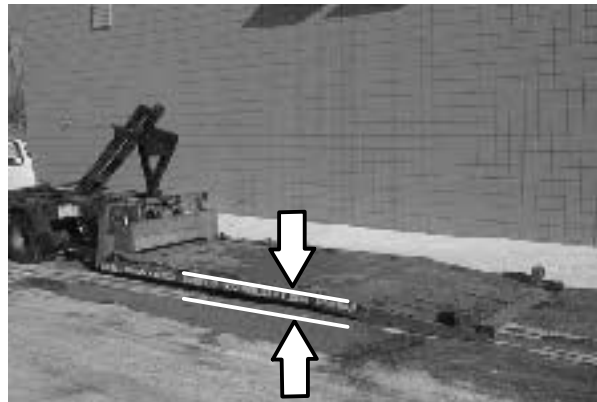

3. To winch the machine onto the truck or trailer, remove the hopper and place a strap through the front frame of the machine. Make sure the machine is in neutral and is centered.

**FOR SAFETY: When loading machine onto truck or trailer, use winch. Do not push the machine onto the truck or trailer unless the loading surface is horizontal AND is 380 mm (15 in) or less from the ground.**



4. Position the machine onto the truck or trailer as far as possible. If the machine starts to veer off the centerline of the truck or trailer, stop and center the machine.

## GENERAL INFORMATION

5. Block the machine tires and place the directional control lever in Park. Tie down the machine to the truck or trailer before transporting.

Secure the rear of the machine by wrapping straps around each end of the the handle and fastening them to the truck or trailer.



Secure the front of the machine by wrapping a strap around the hopper and fastening it to the truck or trailer.



6. If the loading surface is not horizontal or is higher than 380 mm (15 in) from the ground, use a winch to unload machine.

If the loading surface is horizontal AND is 380 mm (15 in) or less from the ground, the machine may be pushed off the truck or trailer.

**FOR SAFETY: When unloading machine off truck or trailer, use winch. Do not push the machine off the truck or trailer unless the loading surface is horizontal AND 380 mm (15 in) or less from the ground.**

## MACHINE STORAGE

When storing the machine for extended periods of time, the following procedures must be followed:

1. Raise the main and side brush(es).

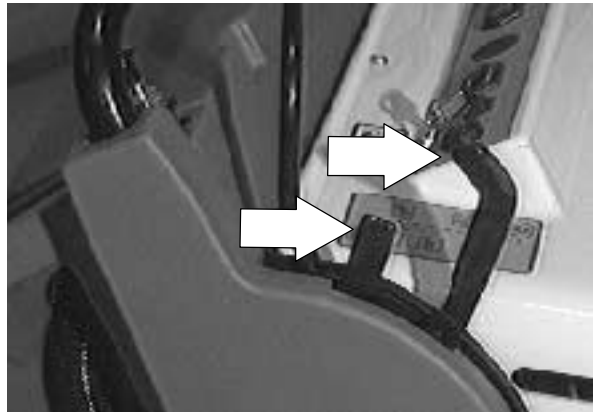

2. Empty and clean the debris hopper.



3. Drain or disconnect and remove (LPG tank) fuel system.

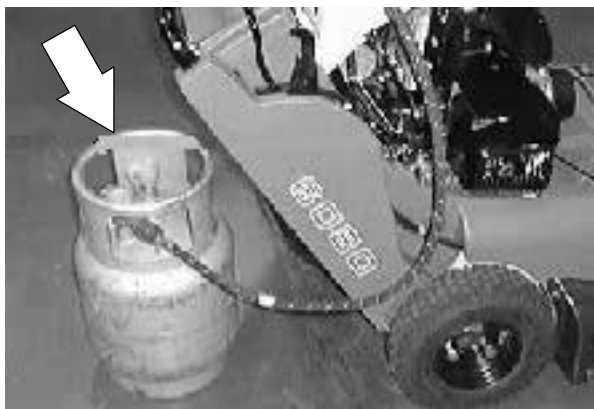

## GENERAL INFORMATION

4. Change the engine oil.



5. Remove the spark plug, pour 30 cc (1 oz) of engine oil into the cylinder, and slowly rotate the crankshaft to distribute the oil. Replace the spark plug.

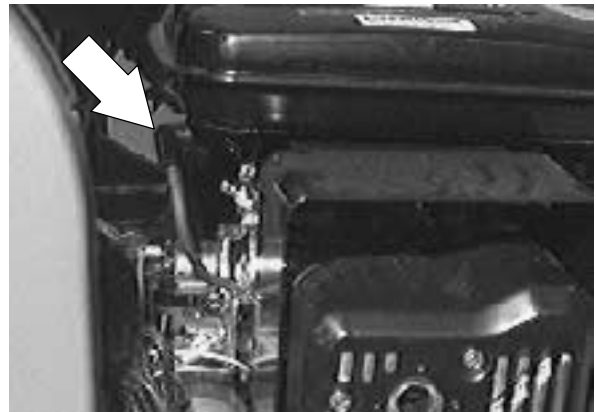

6. Clean the engine cooling fins.

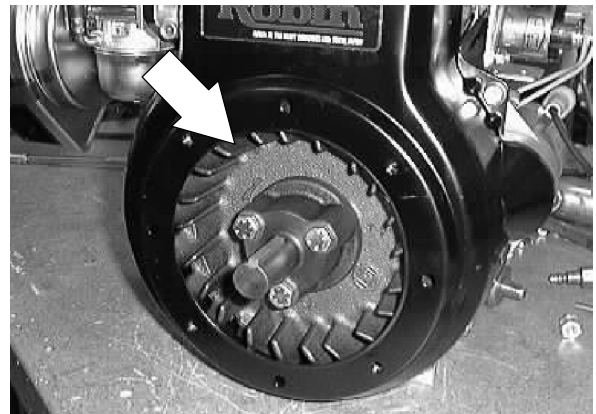

7. Store the machine in a clean dry area.

### STATIC DRAG CHAIN

The static drag chain prevents the buildup of static electricity in the machine. The chain is attached to the backstop bracket.

Make sure the chain is always touching the floor.

Always use an internal tooth lock washer between the chain and rear guard to ensure a proper electrical connection.



## HARDWARE INFORMATION

The following charts state standard plated hardware tightening ranges for normal assembly applications. Decrease the specified torque by 20% when using a thread lubricant. Do not substitute lower grade hardware for higher grade hardware. If higher grade hardware than specified is substituted, tighten only to the specified hardware torque value to avoid damaging the threads of the part being threaded into, as when threading into speed nuts or weldments.

### STANDARD BOLT TORQUE CHART

Thread Size	SAE Grade 5 Torque ft lb (Nm)	SAE Grade 8 Torque ft lb (Nm)
0.25 in	7-10 (9-14)	10-13 (14-38)
0.31 in	15-20 (20-27)	20-26 (27-35)
0.38 in	27-35 (37-47)	36-47 (49-64)
0.44 in	43-56 (58-76)	53-76 (72-103)
0.50 in	65-85 (88-115)	89-116 (121-157)
0.62 in	130-170 (176-231)	117-265 (159-359)
0.75 in	215-280 (291-380)	313-407 (424-552)
1.00 in	500-650 (678-881)	757-984 (1026-1334)

*NOTE: Decrease torque by 20% when using a thread lubricant.*

### METRIC BOLT TORQUE CHART





Thread Size	Class 8.8 Torque ft lb (Nm)	Class 10.9 Torque ft lb (Nm)
M4	2 (3)	3 (4)
M5	4 (5)	6 (8)
M6	7 (9)	10 (14)
M8	18 (24)	25 (34)
M10	32 (43)	47 (64)
M12	58 (79)	83 (112)
M14	94 (127)	133 (180)
M16	144 (195)	196 (265)
M20	260 (352)	336 (455)
M24	470 (637)	664 (900)

*NOTE: Decrease torque by 20% when using a thread lubricant.*

Exceptions to the above chart:

Check the machine for exceptions!

### BOLT IDENTIFICATION

Identification Grade Marking	Specification and Grade
	SAE-Grade 5
	SAE-Grade 8
	ISO-Grade 8.8
	ISO-Grade 10.9

01395

### THREAD SEALANT AND LOCKING COMPOUNDS

Thread sealants and locking compounds may be used on this machine. They include the following:

Loctite 515 sealant - gasket forming material. TENNANT Part No. 75567, 15 oz (440 ml) cartridge.

Loctite 242 blue - medium strength thread locking compound. TENNANT Part No. 32676, 0.5 ml tube.

Loctite 271 red - high strength thread locking compound. TENNANT Part No. 19857, 0.5 ml tube.



## CONTENTS

	Page
INTRODUCTION .....	2-3
REAR TIRES AND WHEELS .....	2-4
TO REMOVE REAR TIRE .....	2-4
TO INSTALL REAR TIRE .....	2-5
CASTERS .....	2-6
TO REPLACE FRONT CASTERS ....	2-6
SHIFT CABLE .....	2-7
TO REPLACE SHIFT CABLE .....	2-7
TO ADJUST SHIFT CABLE .....	2-13
TRANSAXLE/TRANSMISSION .....	2-15
TO REMOVE TRANSAXLE .....	2-15
TO INSTALL TRANSAXLE .....	2-19
TRANSAXLE BREAKDOWN .....	2-22
TO REPLACE FLAT DRIVE BELT ...	2-23
TO REPLACE DRIVE BELT IDLER	
CABLE (clutch handle cable) ....	2-26
TO REPLACE DRIVE BELT IDLER	
PULLEY .....	2-32



**INTRODUCTION**

This section includes information on the main chassis related components for example the rear wheels, casters, and transaxle.

## REAR TIRES AND WHEELS

The rear tires and wheels drive the machine through the transaxle. The tires are solid. Wide track pneumatic tire are available as an option.

### TO REMOVE REAR TIRE

**FOR SAFETY: Before Leaving Or Servicing Machine; Stop On Level Surface, Place Shifter In Park.**

1. Lift the rear of the machine by tipping the machine back and placing blocks under the machine frame in front of the wheels. Let the machine go forward to contact the blocks. The rear wheels will lift off the floor.
2. Remove the flat head screw holding the hub cap to the drive wheel.

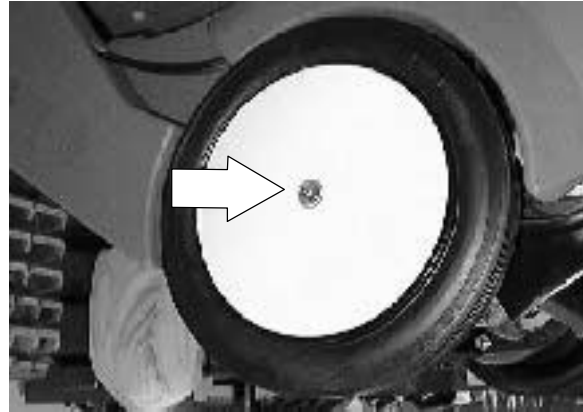

3. Pull the hub cap off the drive wheel.

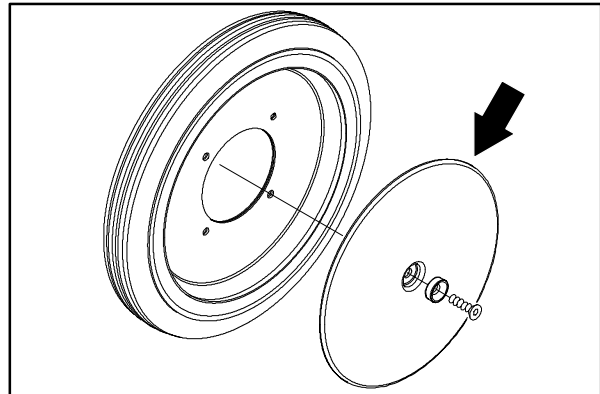

4. Pull the tire and wheel assembly off the drive axle. Be careful not to loose pin from axle cross hole.

**TO INSTALL REAR TIRE**

**FOR SAFETY: Before Leaving Or Servicing Machine; Stop On Level Surface, Place Shifter In Park.**

1. Position the tire and wheel assembly on the drive axle. Make sure the pin in the axle lines up with the slot in the black plastic hub.

*NOTE: Place machine in Neutral, then, rotate axle until cross pin is horizontal. Put machine in Park and install hub/wheel assembly.*

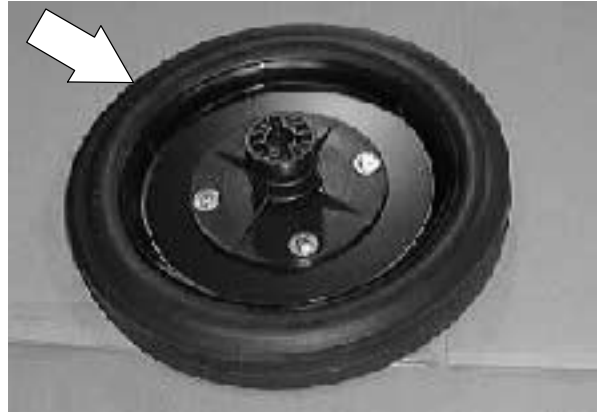

2. Install the hub cap on the drive wheel.

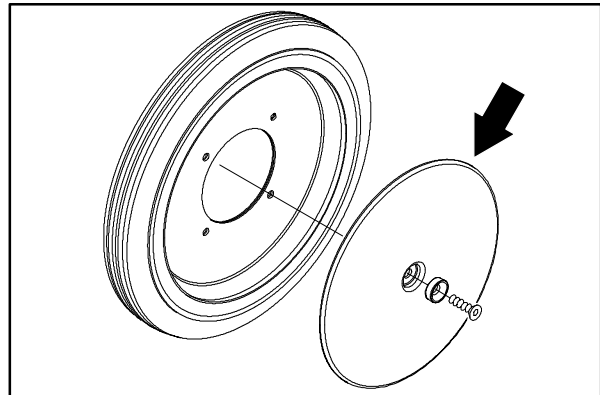

3. Install the flat head screw in the end of the axle. Tighten to 7.6 - 9.9 Nm (6 - 8 ft lb).

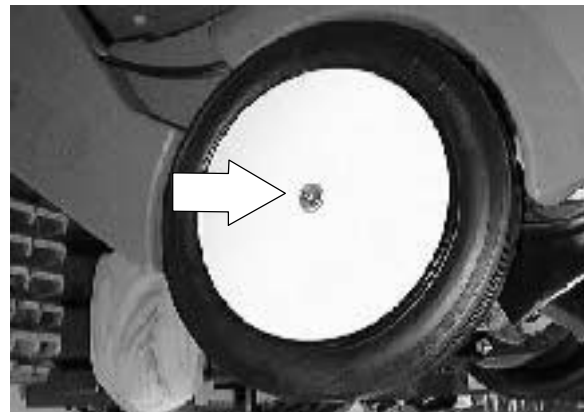

4. Remove the blocks and lower the machine.

## CASTERS

The front casters support the front end of the machine. They swivel to allow the front of the machine to be maneuvered easily into corners or around obstacles. The casters should be replaced when they no longer roll or swivel freely.

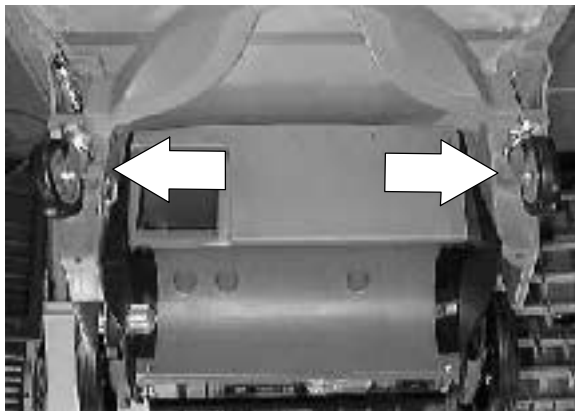

### TO REPLACE FRONT CASTERS

**FOR SAFETY: Before Leaving Or Servicing Machine; Stop On Level Surface, Place Shifter In Park.**

1. Remove the debris hopper from the machine.
2. Raise the front of the machine and install blocks under the frame.

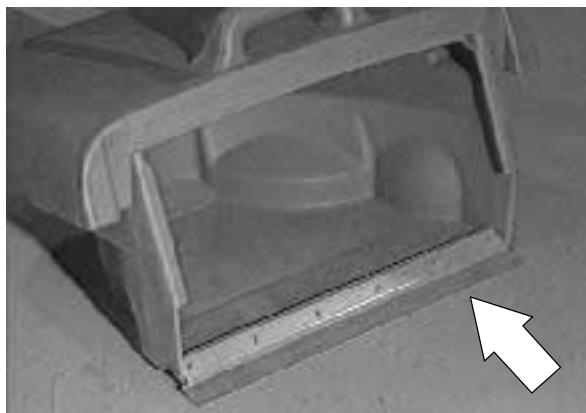

3. Remove the two hex screws holding the caster to the front of the machine frame. Remove the caster from the machine.
4. Position the new caster on the front of the machine.
5. Install the two hex screws and tighten to 18 - 24 Nm (15 - 20 ft lb).
6. Remove the blocks and lower the machine.
7. Operate the machine and check the new caster for proper operation.

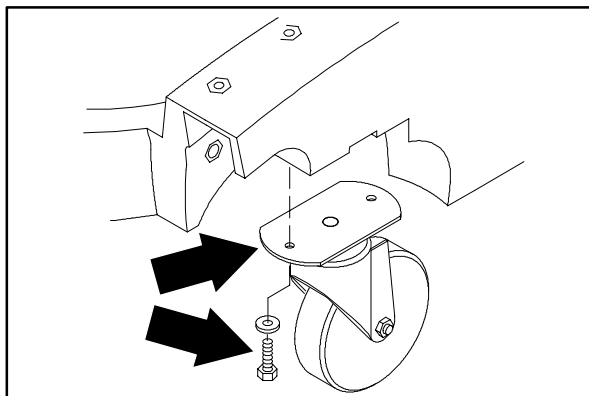

---

## SHIFT CABLE

---

The gear selection on the model 3640 is made with the directional control lever on the left side of the machine handle. The shift cable runs from the lever on the handle to the lever on the transaxle.

### TO REPLACE SHIFT CABLE

**FOR SAFETY: Before Leaving Or Servicing Machine; Stop On Level Surface, Place Shifter In Park.**

1. Remove the filter cover from the rear of the machine.



2. Move the directional control lever to the park position.



3. Remove the handle stop bracket from the upper/left side of the filter compartment.

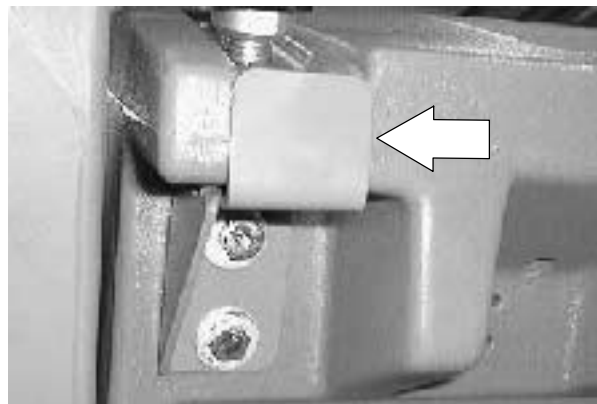

## CHASSIS

4. Pull up on the two handle locks and move the handle assembly to its lowest position.

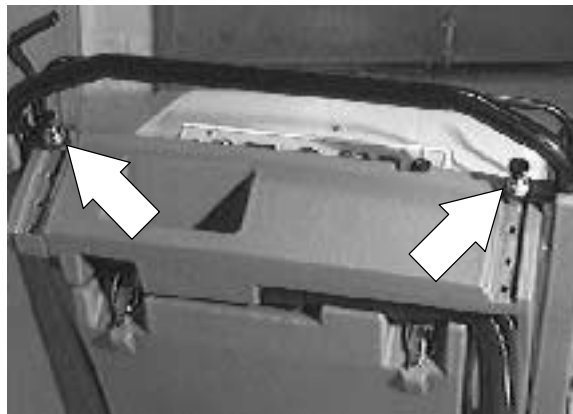

5. Remove the three screws holding the cover plate to the inside of the left side handle tower. Remove the cover plate from the machine.

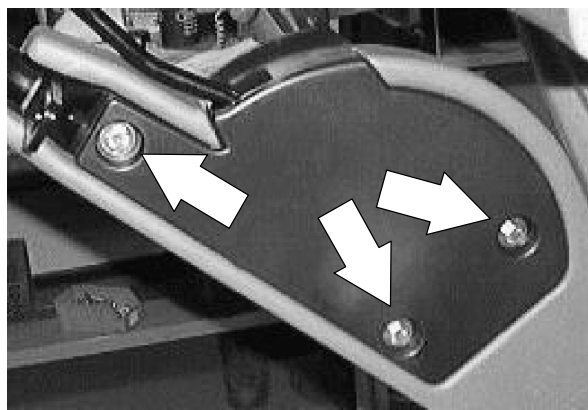

6. Loosen the nut holding the directional control lever to the mount plate. Move the directional control lever out away from the mount plate.

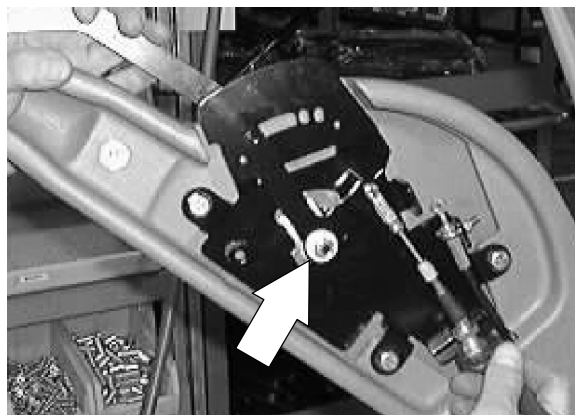

7. Remove the cotter pin and clevis pin from the end of the shift cable.

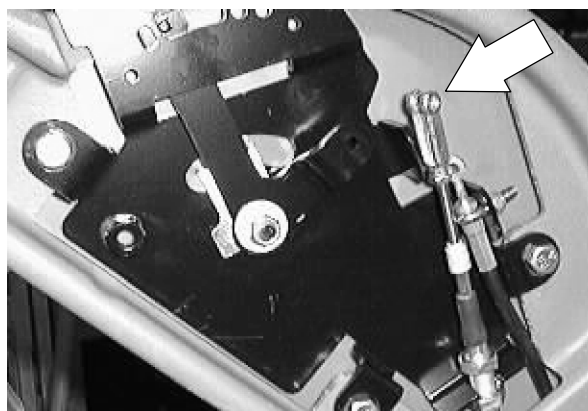



- Loosen the jam nut on the cable where it attaches to the handle assembly. Move the cable out of the slot.

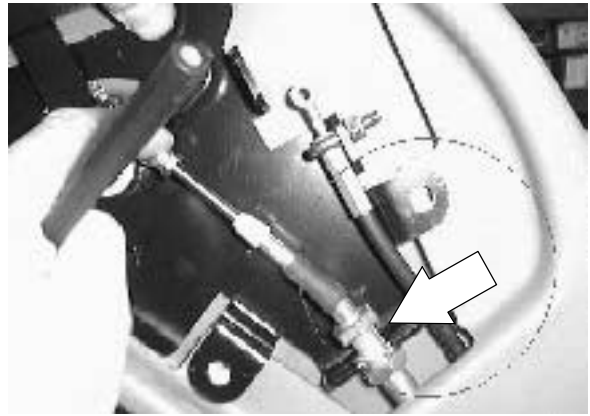

- Go down to the transaxle and locate the shift link on the left side of the housing. Pop the shift cable end off the ball end on the shift link.

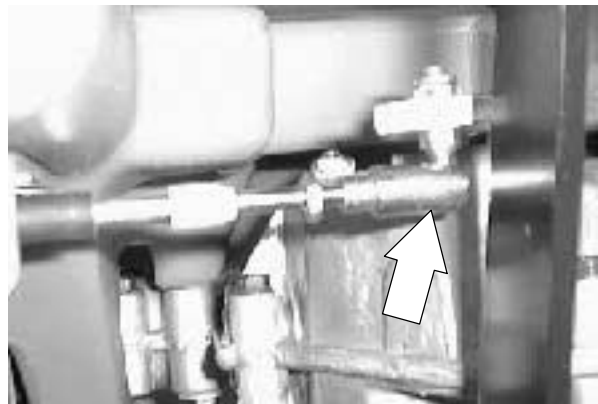

- Remove the two hex screws holding the shift cable mount clamp to the machine frame.

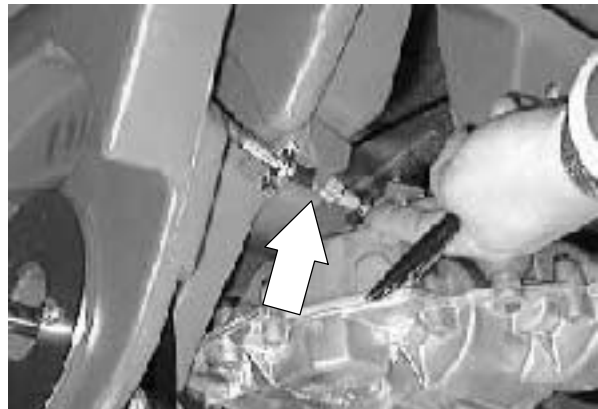

- Remove the shift cable mounting clamp from the cable.

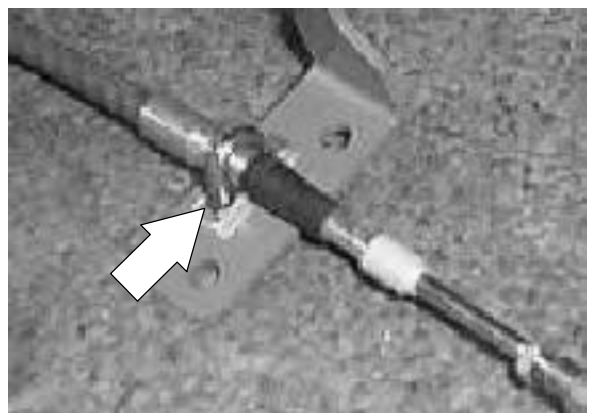

## CHASSIS

12. Remove the cable from the machine by pulling it up and out of the slot in the handle assembly.

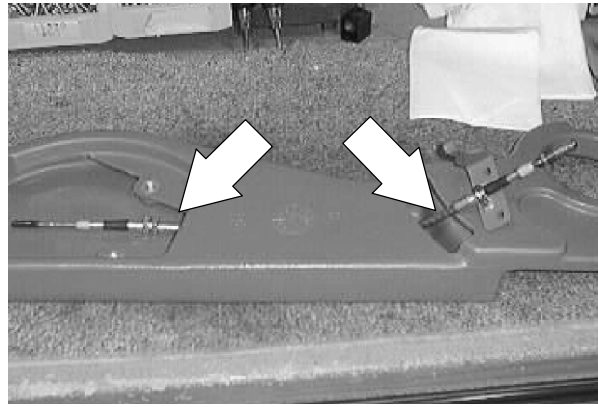

13. Remove both cable ends and jam nuts. Install on the new cable in the same orientation.

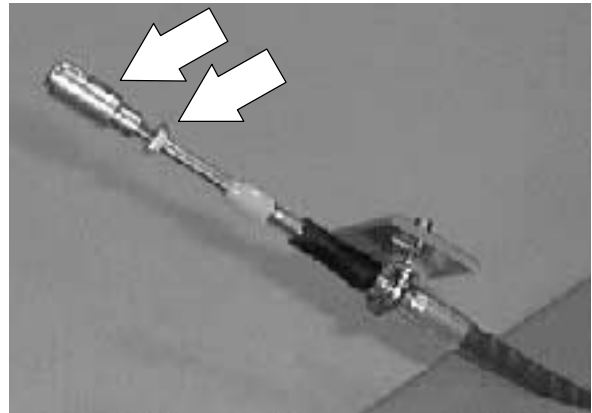

14. Install the new cable assembly in the machine. Make sure the end with the two larger jam nuts is positioned near the upper shift lever.

*NOTE: Start with the mounting jam nuts about half way down on the threads of the cable.*

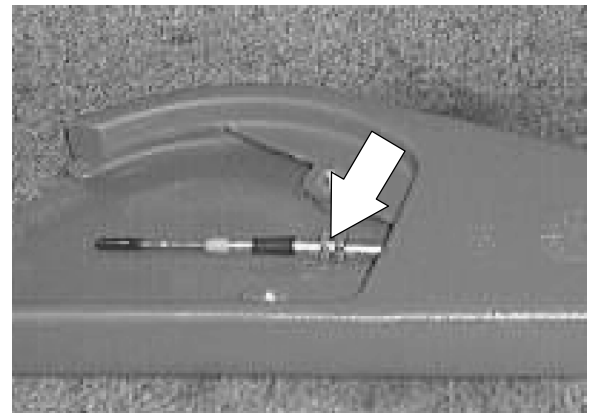

15. Place the cable and jam nuts in the slot of the mount plate with 2-3 threads showing above the upper nut. Firmly tighten the jam nuts.

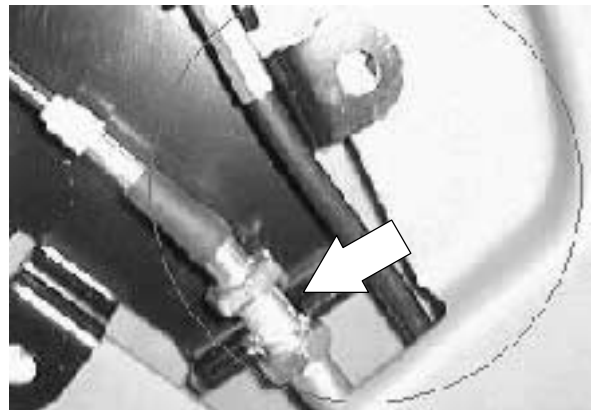

16. Reinstall the cotter pin and clevis pin into the end of the shift cable clevis.

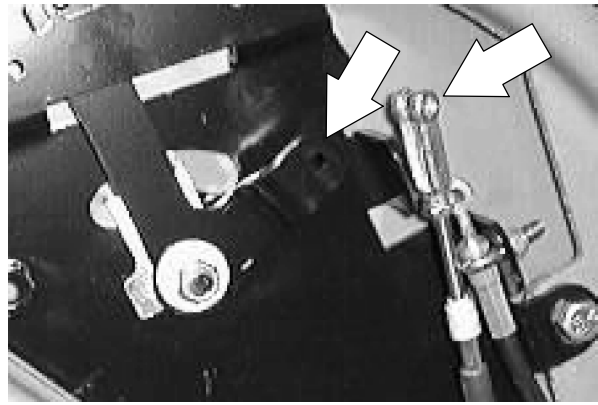

17. Reinstall the shift cable mount clamp on the machine frame. Tighten the two hex screws to 7.6 - 9.9 Nm (6 - 8 ft lb).



18. Make sure the upper shift lever is placed in the PARK position. Snap the shift cable end over the ball end on the lower shift link. Adjust the cable end in or out as needed so it is aligned with the ball end on the link. Re-tighten the jam nut against the cable ball end.

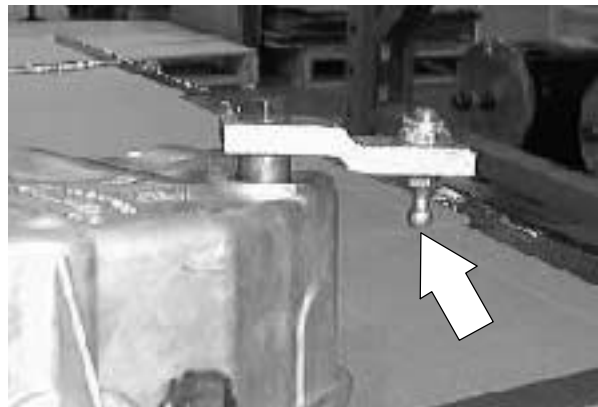

19. Reinstall the left side handle assembly cover plate. Tighten the three hex screws to 18 - 24 Nm (15 - 20 ft lb).

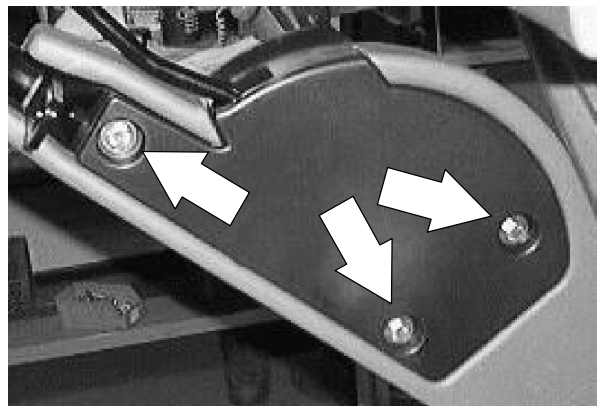

## CHASSIS

20. Move the handle assembly up to one of the four adjustment holes.

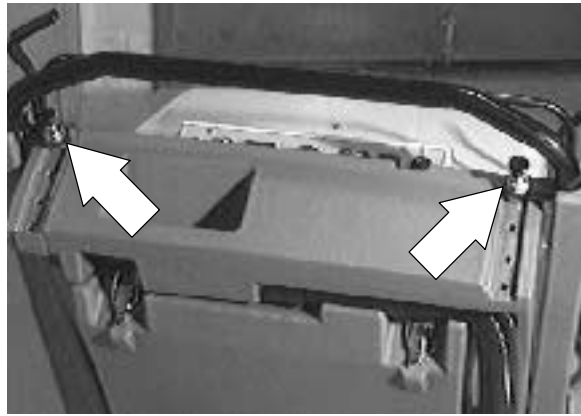

21. Reinstall the filter cover and handle stop bracket.

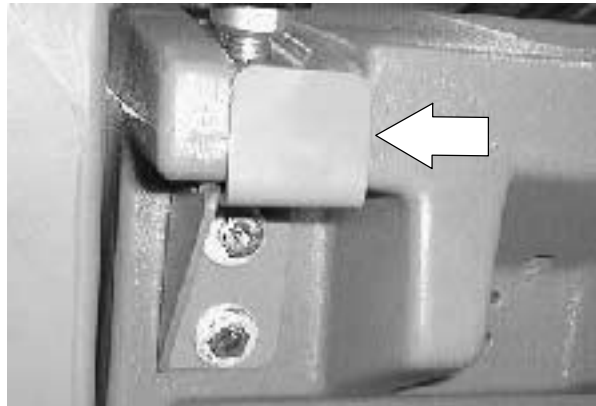

22. Start the machine and check the shift lever for proper gear selection and operation. If the shift lever does not operate properly, see TO ADJUST SHIFT CABLE instructions in this section.

**TO ADJUST SHIFT CABLE**

**FOR SAFETY: Before Leaving Or Servicing Machine; Stop On Level Surface, Place Shifter In Park.**

1. Pull the upper shift lever back until it is firmly in the park position hole.



2. Go down to the shift link on the left side of the transaxle. Pop the cable end off the ball end on the link.

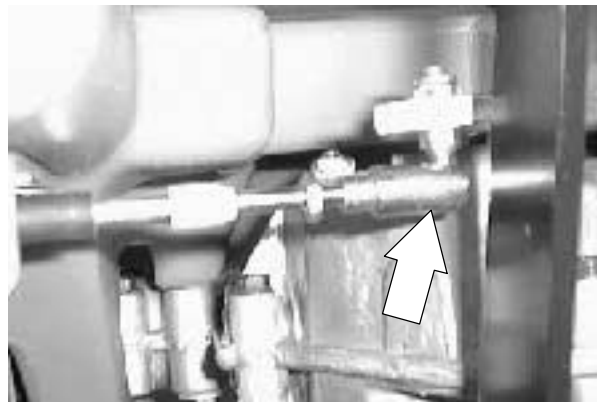

3. Once the cable end is off the ball end, verify that the shift link is in the PARK detent.

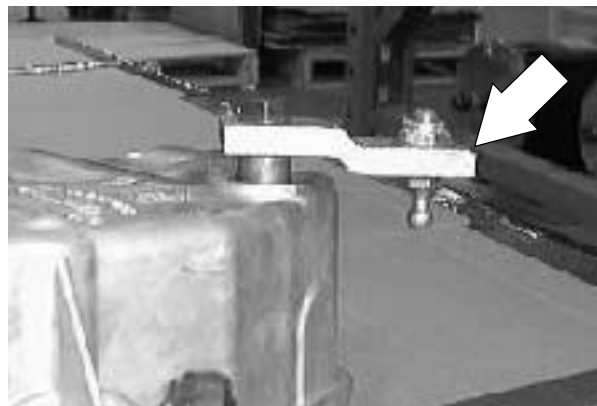

## CHASSIS

4. Once it is verified that the shift link is in the PARK detent, check the alignment of the ball end to the shift cable end. These two parts should line up perfectly--if not--loosen the cable end jam nut and move the cable end in or out to achieve the proper adjustment. *Re-tighten the jam nut.*

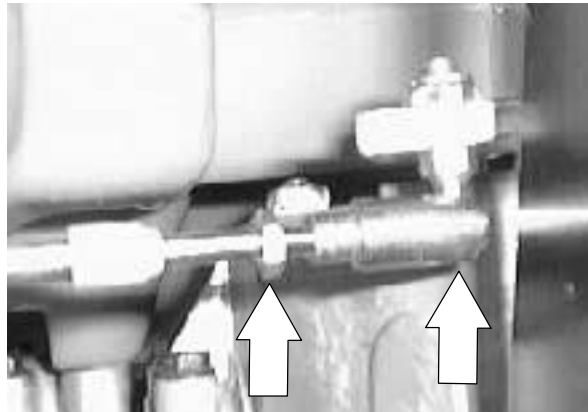

5. If more adjustment is needed, the shift cable can be adjusted at the two jam nuts behind the plastic handle cover or at the upper clevis.

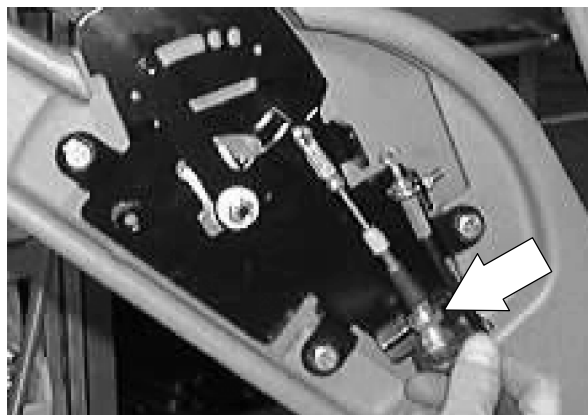

---

**TRANSAXLE/TRANSMISSION**

---

The 3640 is equipped with a transaxle transmission assembly. The transmission has three forward speeds, neutral, reverse, and park. The shift lever is on the left hand side of the machine, near the grip handle. The transmission can be shifted quickly between forward, neutral, and reverse by pushing or pulling the shift lever.

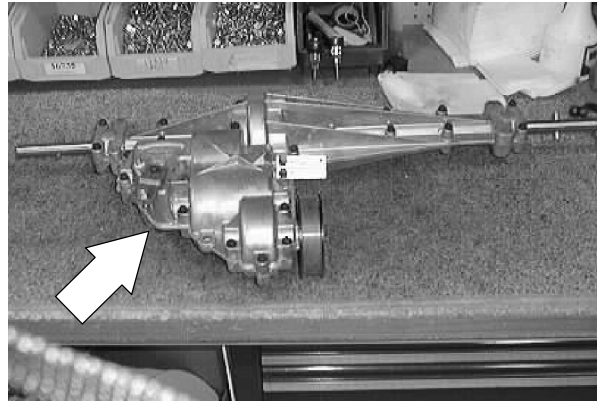
**TO REMOVE TRANSAXLE**

**FOR SAFETY: Before Leaving Or Servicing Machine; Stop On Level Surface, Place Shifter In Park.**

1. Lift the rear of the machine until the drive wheels are off the floor.
2. Place blocks under the machine frame.
3. Remove the rear cover from the drive belt.

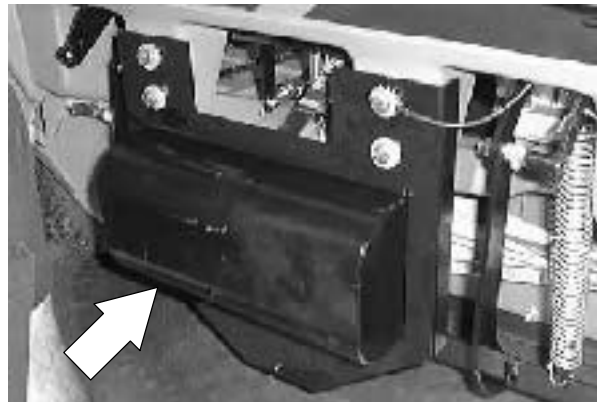

4. Slip the main drive belt off the sheave on the transaxle.



## CHASSIS

5. Remove the flat head screw holding each hub cap to the drive wheels.

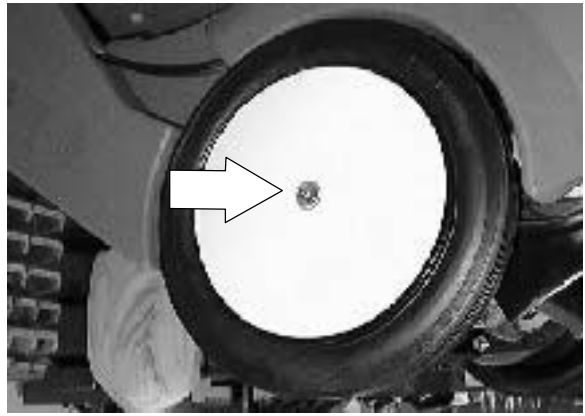

6. Pull the hub cap and drive wheel off each side of the machine.

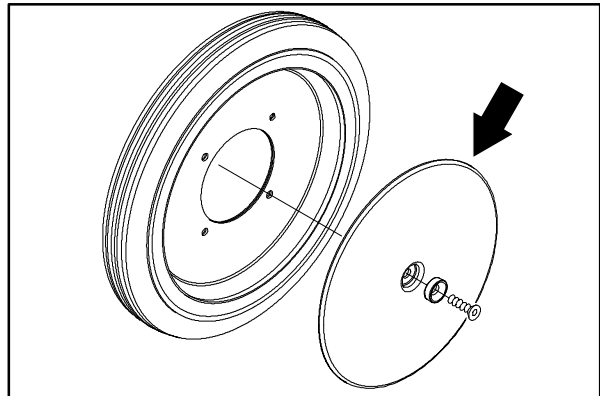

7. Remove the hex screw, sleeve, and nut holding the left side of the brush shaft to the left side of the brush arm.

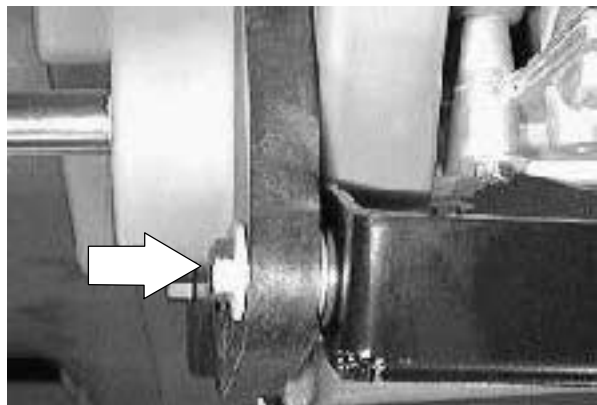

8. Remove the two hex screws holding the shift cable mount clamp to the machine frame.





9. Pop the shift cable off the ball end on the shift link at the transaxle.

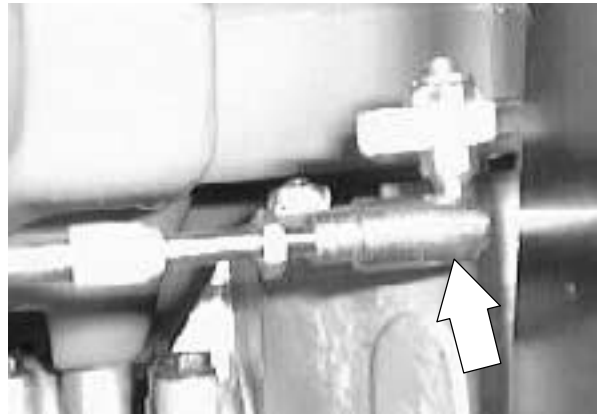

10. Remove the two hex screws holding the brush arm retaining plate to the left side of the machine frame. Remove the retaining plate.

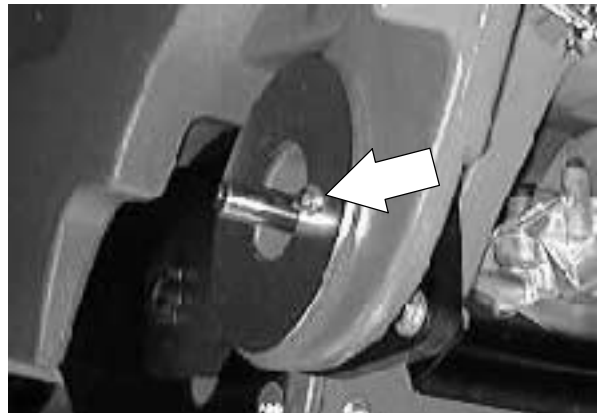

11. Spread the left handle leg out far enough to drop it down past the end of the left axle shaft.



12. Remove the left brush arm and wear ring from the machine frame.

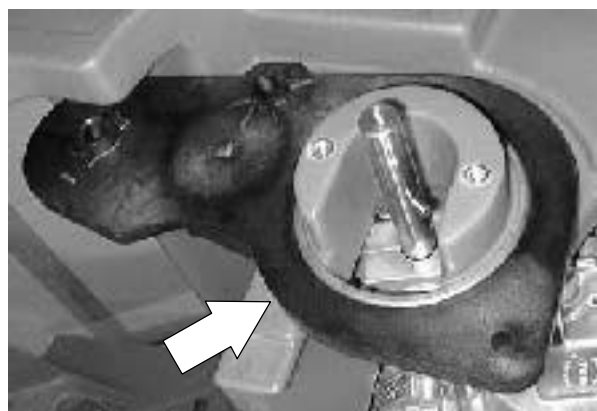

## CHASSIS

13. Remove the five hex screws holding the transaxle to the machine frame.
  
14. First drop the transaxle down out of the left side of the machine then pull it out of the right handle opening and right side brush arm. Remove the transaxle from the machine.

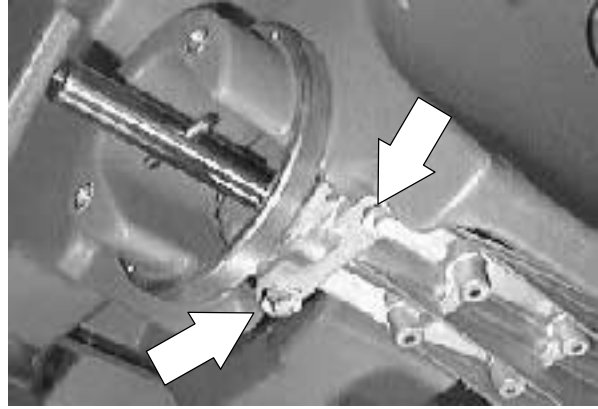

**TO INSTALL TRANSAXLE**

**FOR SAFETY: Before Leaving Or Servicing Machine; Stop On Level Surface, Place Shifter In Park.**

1. Position the transaxle in the machine. First, place the right side of the transaxle through the right handle opening and right brush arm, then, bring the left side of the transaxle up to the left side of the machine frame. *Reinstall the wear ring.*

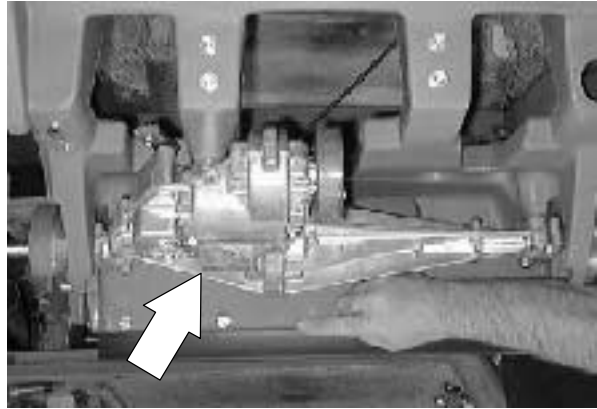

2. Install the five hex screws that hold the transaxle to the bottom of the machine frame. Tighten to 7.6 – 9.9 Nm (6 – 8 ft lb).

*NOTE: Install 3 flat washers under the transaxle where the 30mm hex screw goes.*

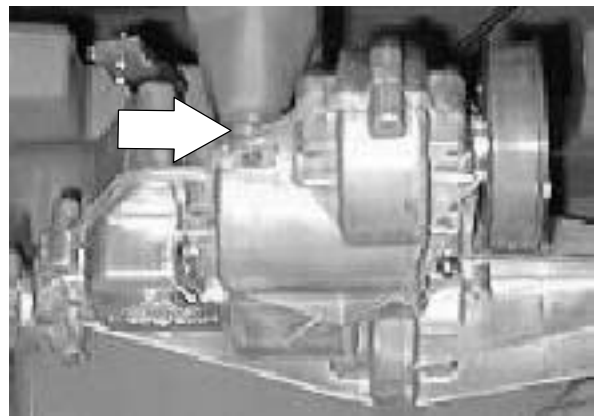

3. Position the wear ring and left brush arm over the end of the left axle shaft.

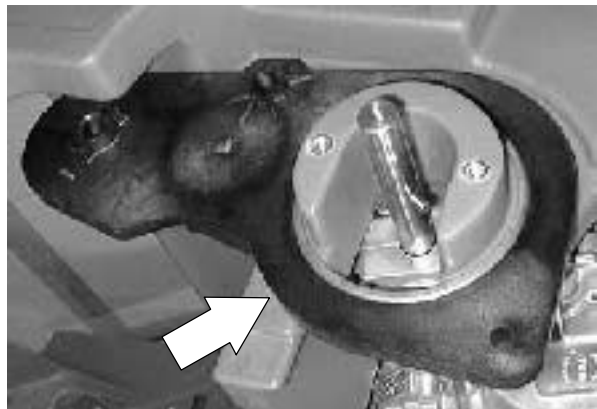

## CHASSIS

4. Spread the left handle leg out far enough to reinstall it over the end of the left axle shaft.



5. Install the left hand brush arm retaining plate on the machine. Tighten the hex screws to 7.6 - 9.9 Nm (6 - 8 ft lb).

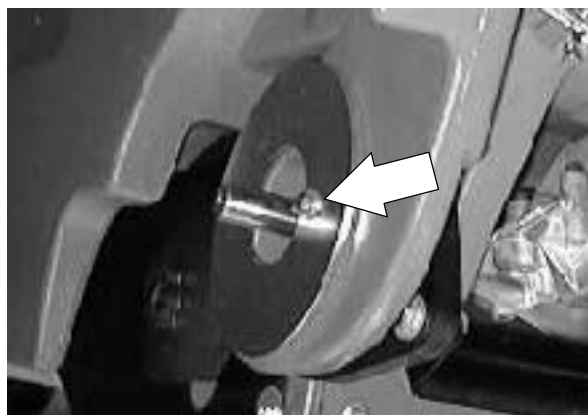

6. Reinstall the hex screw, sheave, and nut holding the left side of the brush shaft to the left brush arm. Tighten the hex screws to 7.6 - 9.9 Nm (6 - 8 ft lb).

*NOTE: The slot in the brush arm is used to adjust the taper of the main brush pattern.*

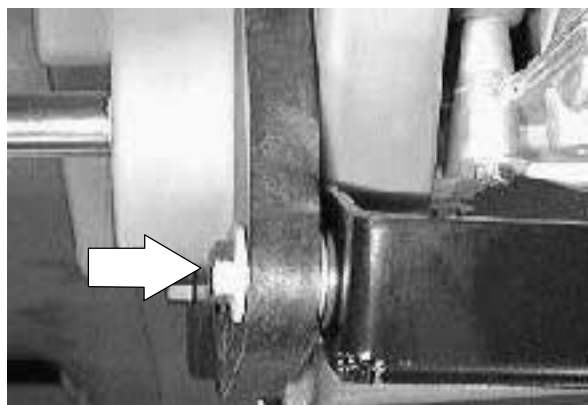

7. Reinstall the shift cable on the ball end on the shift lever.

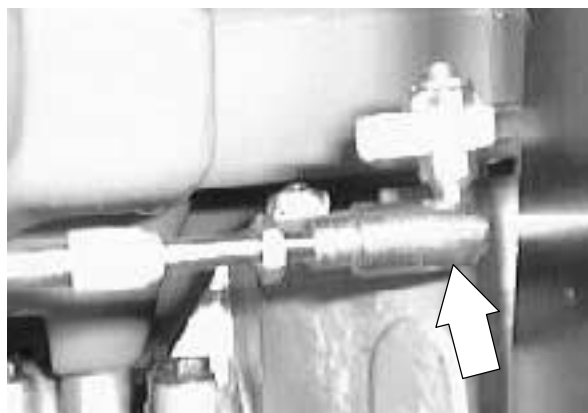

8. Reinstall the two hex screws holding the shift cable mount clamp to the machine frame. Tighten to 7.6 - 9.9 Nm (6 - 8 ft lb).

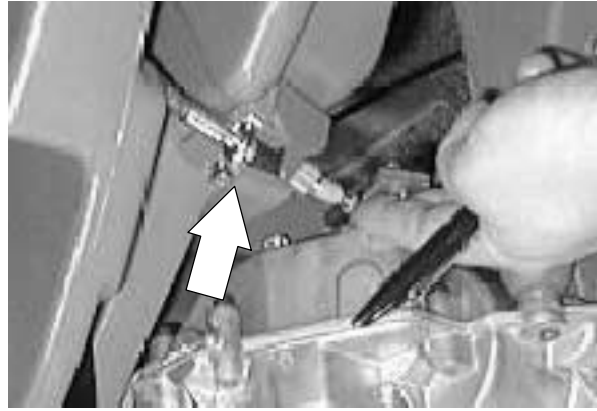

9. Reinstall the main drive belt on the transaxle sheave.

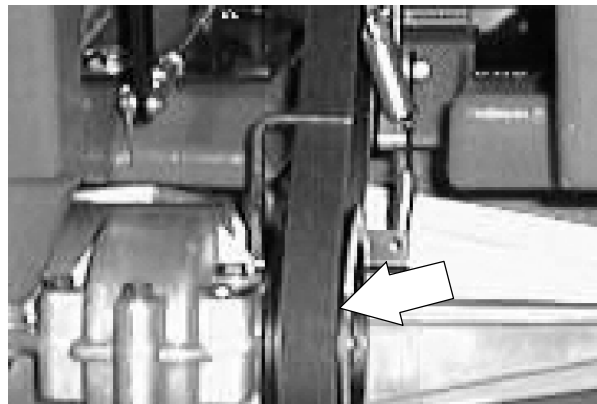

10. Reinstall the rear belt cover on the machine.

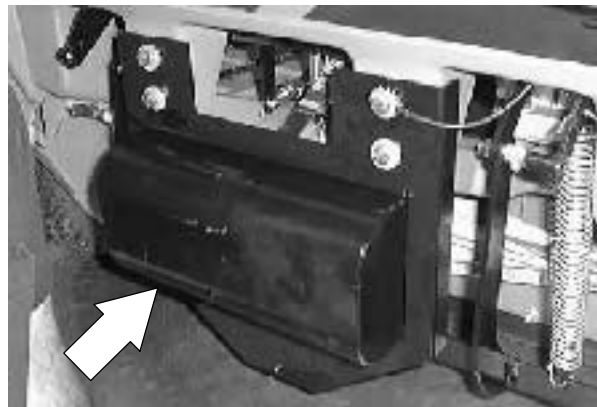

11. Reinstall the rear drive wheels and hub caps. Tighten the flat head screw to 7.6 - 9.9 Nm (6 - 8 ft lb).

*NOTE: Place machine in Neutral and rotate axle until cross pin is horizontal. Put machine in Park. Install hub/wheel assembly.*

12. Remove the blocks and lower the machine. Check for proper operation of the shifter and transaxle. Also check the main brush pattern and adjust if tapered. See TO CHECK AND ADJUST MAIN BRUSH PATTERN instructions in the SWEEPING section.



TRANSAXLE  
BREAKDOWN

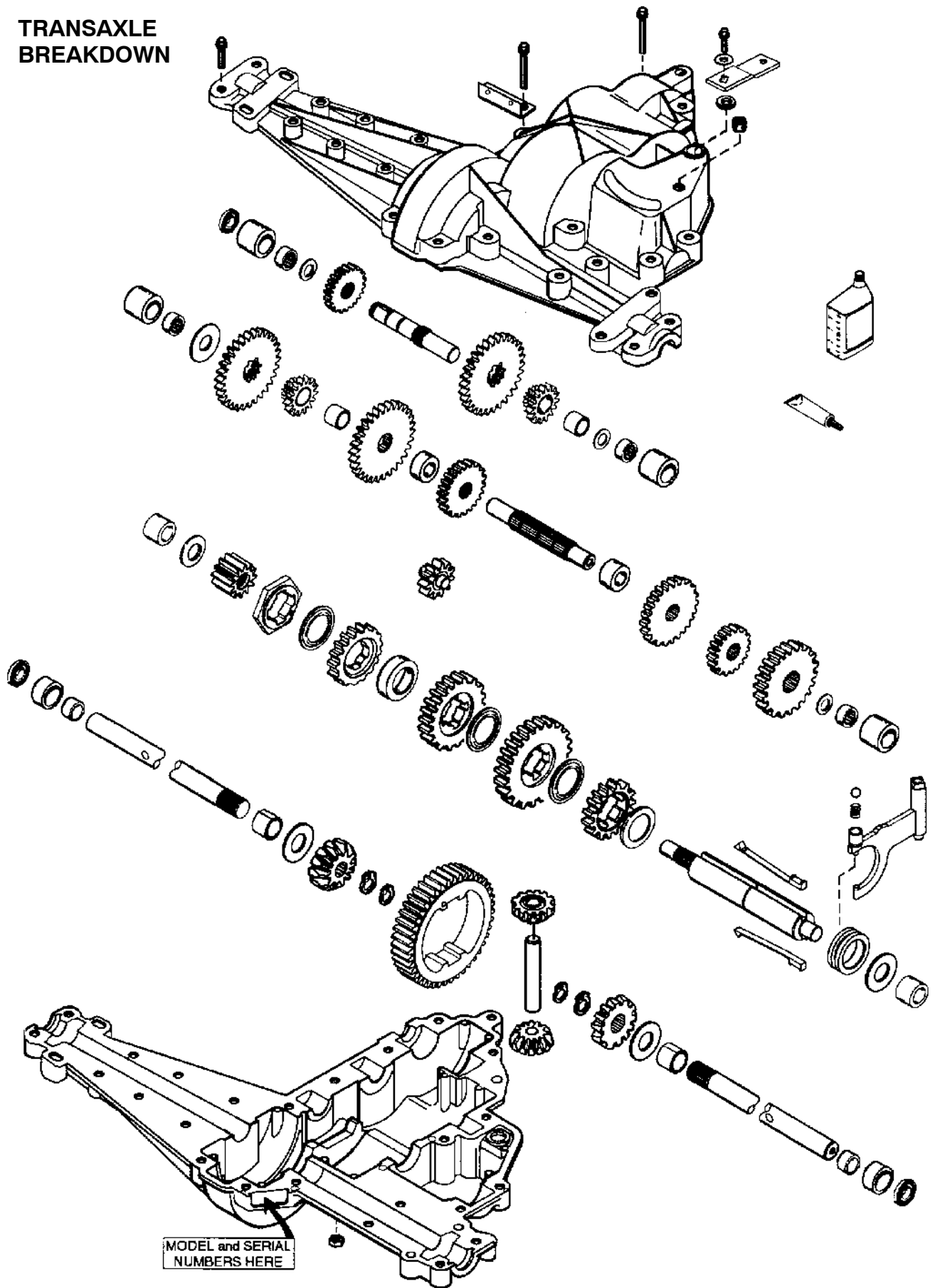

**TO REPLACE FLAT DRIVE BELT**

**FOR SAFETY: Before Leaving Or Servicing Machine; Stop On Level Surface, Place Shifter In Park.**

1. Open the cover and engage the prop rod.

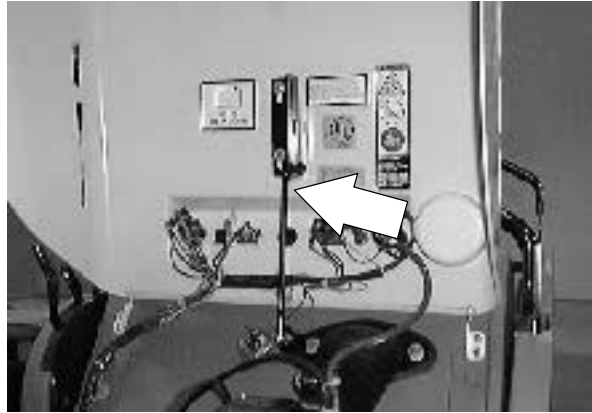

2. Remove the rear cover from the drive belt at the transaxle sheave.

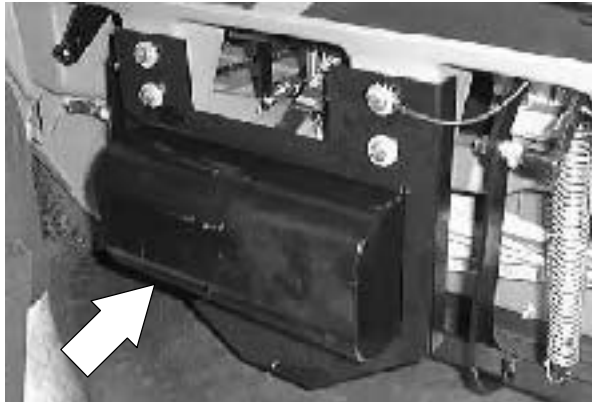

3. Loosen the vacuum fan pivot bolt and remove the vacuum fan belt from the engine sheave.

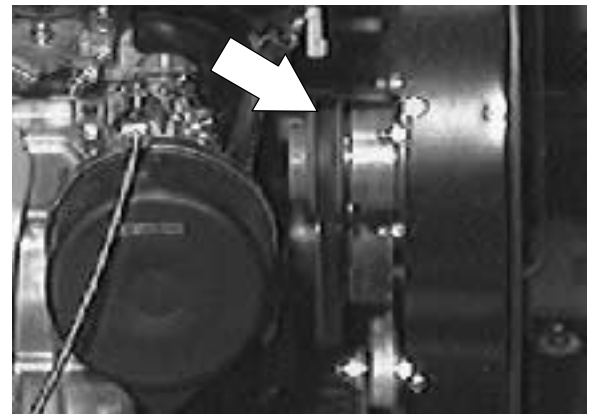

## CHASSIS

4. Slip the flat drive belt off the transaxle sheave.

*NOTE: Make sure no pressure is being applied to the clutch bar when changing the drive belt.*

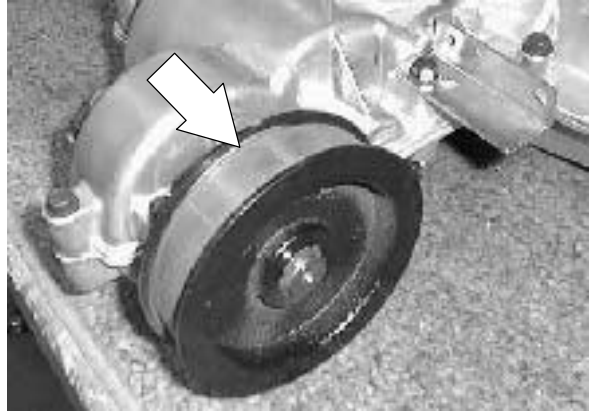

5. Slip the drive belt off the engine sheave. Remove the drive belt.
6. Install the new drive belt on the engine sheave.



7. Install the new drive belt on the transaxle sheave.

*NOTE: Make sure the new belt is over the clutch idler pulley.*

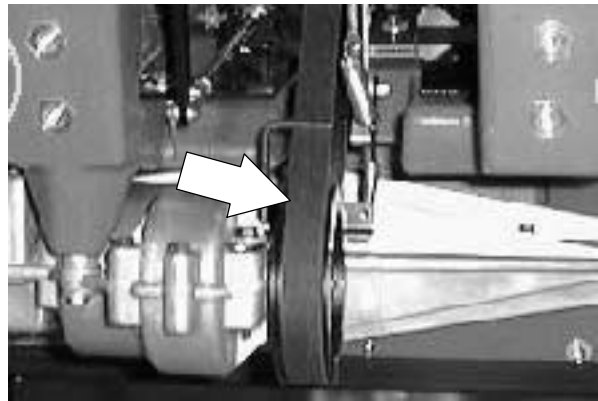

8. Adjust the belt stop so it just clears the flat belt when it is tight. *This to stop the belt from moving when the machine is in neutral.*

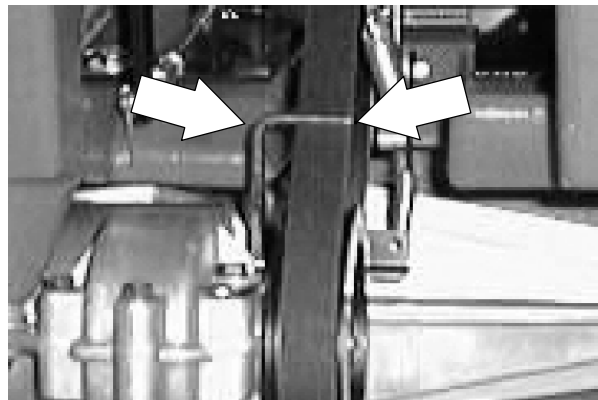



9. Reinstall the vacuum fan belt.

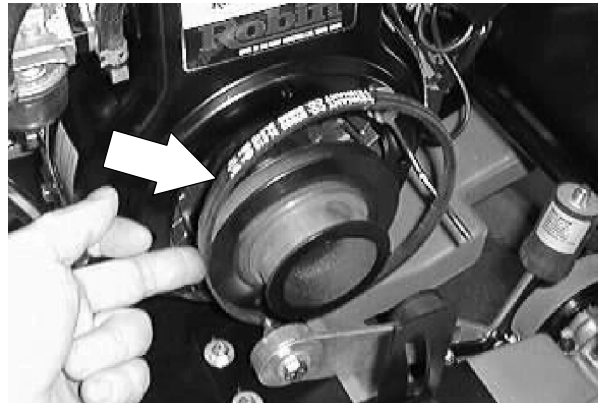

10. Pull up on the vacuum fan assembly until the V-belt is tight. Check belt tension by applying a force 1 kg (2 lb) at belt midpoint. The proper deflection should be 5 mm (0.09 in). Tighten the tension bolt to 18 - 24 Nm (15 - 20 ft lb).

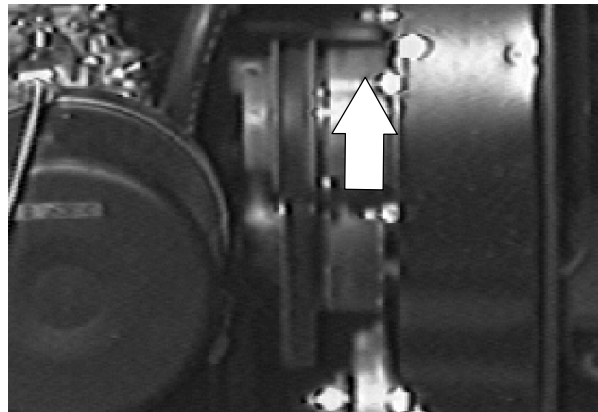

11. Reinstall the rear belt cover on the machine.

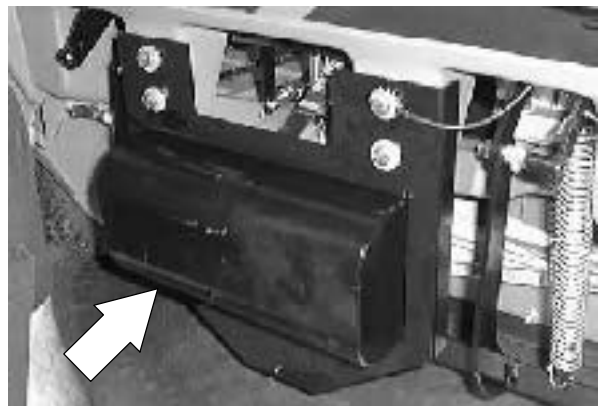

12. Start the machine and operate the clutch bar. Check for proper engagement of the new belt and smooth operation.

## CHASSIS

### TO REPLACE DRIVE BELT IDLER CABLE (clutch handle cable)

**FOR SAFETY: Before Leaving Or Servicing Machine; Stop On Level Surface, Place Shifter In Park.**

1. Remove the filter cover from the rear of the machine.



2. Remove the handle stop bracket from the upper/left side of the filter compartment.

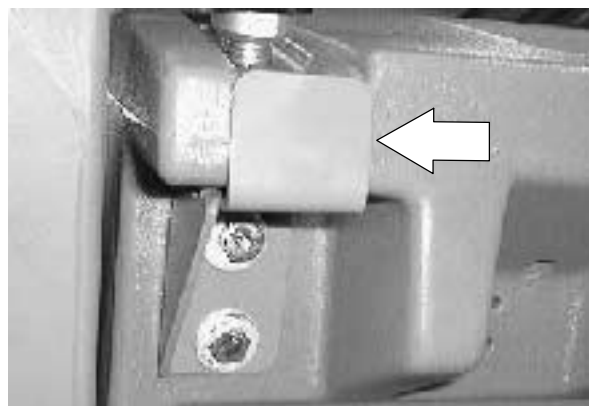

3. Pull up on the two handle locks and move the handle assembly to its lowest position.

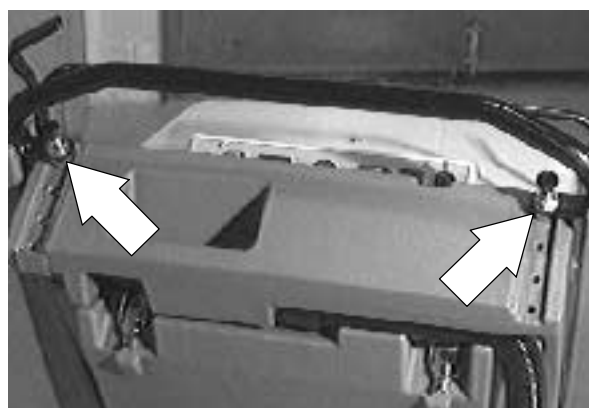

4. Remove the three hex screws holding the cover plate to the inside of the left side handle tower. Remove the cover plate from the machine.

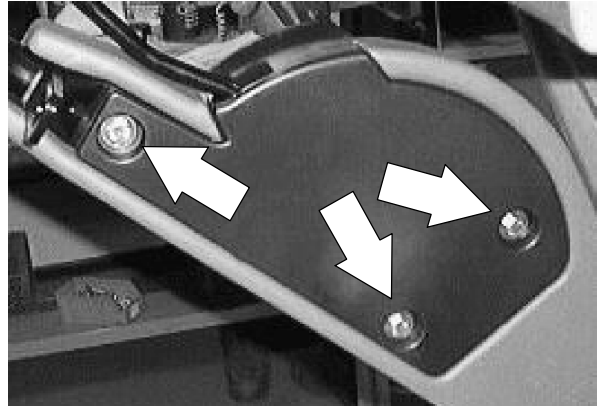

5. Open the engine cover and engage the prop rod.



6. Go to the area below the vacuum fan and locate the tension spring leading from the idler pulley arm to the end of the drive belt idler cable. Disconnect the spring from the cable.

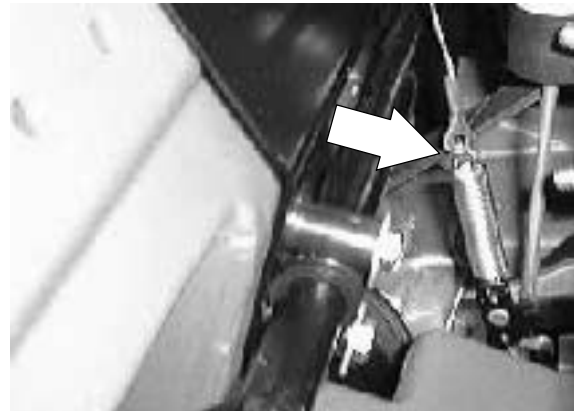

7. Loosen the two jam nuts on the cable where it mounts to the bracket near the shaker motor. Slip the cable out of the mount slot.



## CHASSIS

8. Remove the cable clamp from the vacuum fan housing.

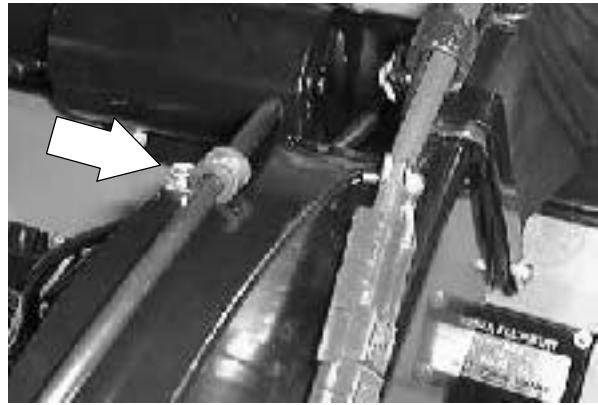

9. Go to the left side handle area and locate the end of the drive belt idler cable. Remove the cotter pin and clevis pin from the end of the clutch cable.

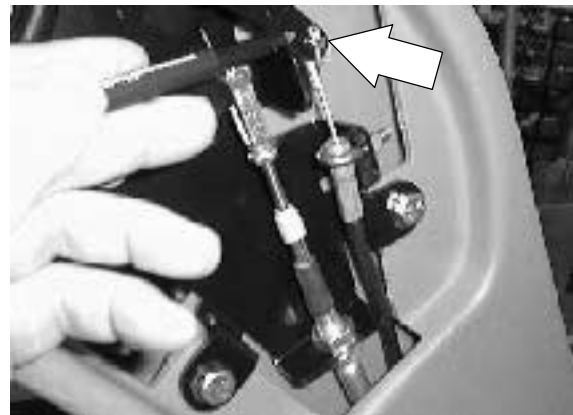

10. Remove the nut holding the clutch cable clamp to the cable lever mount plate. *Note the position of the clamp and cable.*

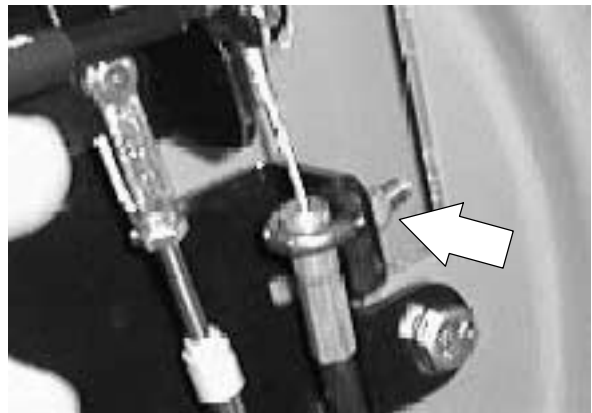

11. Remove the cable from the machine by pulling it toward the vacuum fan.

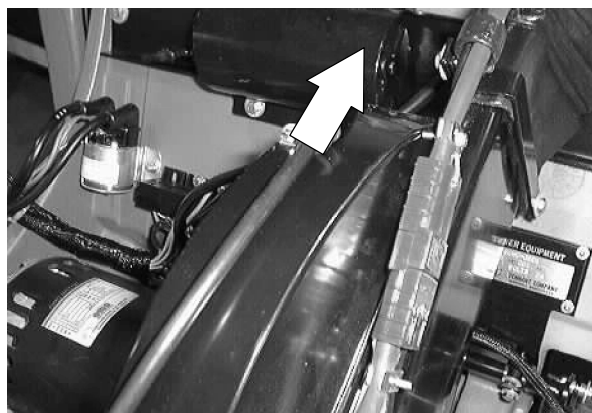

12. Install the new cable by feeding the end (without the jam nuts) through the hole in the front of the frame. Guide the cable toward the back of the machine. Use the finger hole in the front left corner to guide the cable. Then feed the cable up the left side arm to the clutch bar.

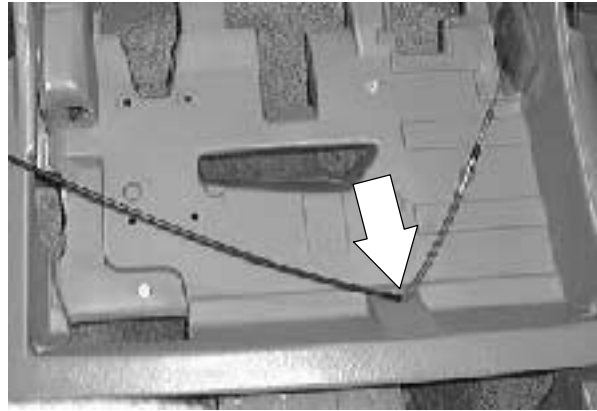

13. Position the cable into the mount bracket slot near the shaker motor. Tighten the two jam nuts.

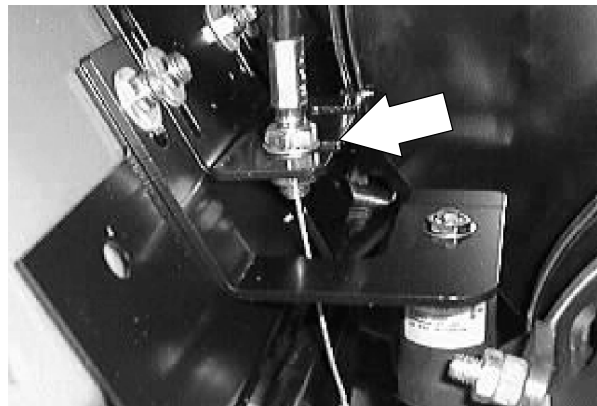

14. Connect the tension spring from the idler arm to the end of the new drive belt idler cable.

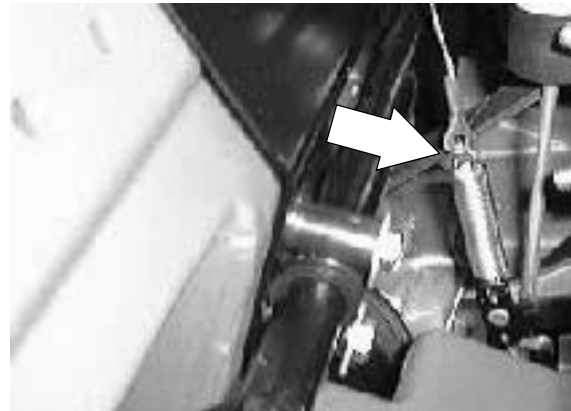

15. Reinstall the cable in the clamp on the vacuum fan housing.



## CHASSIS

16. Reinstall the clamp and nut onto the new cable in the handle area. Tighten to 7.6 - 9.9 Nm (6 - 8 ft lb).

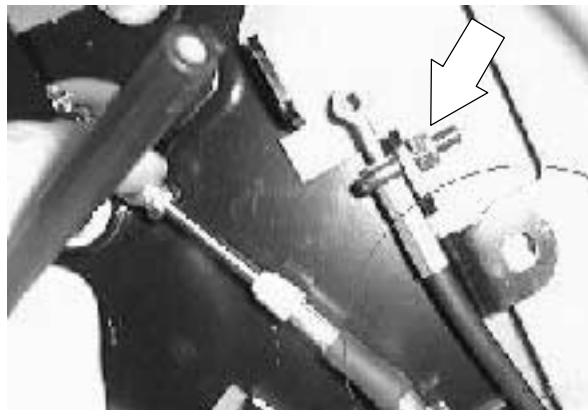

17. Reinstall the clevis pin and cotter pin in the end of the new cable and clutch bar.

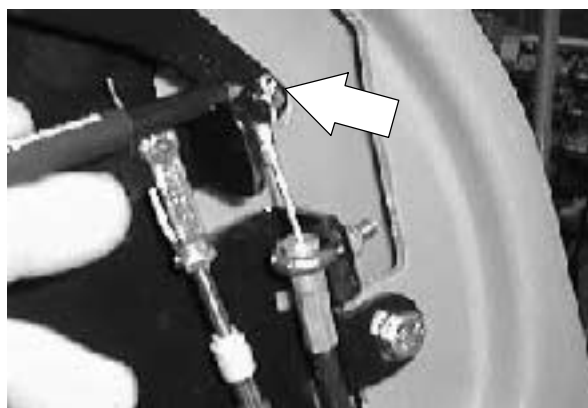

18. Reinstall the left side cover plate. Tighten the three hex screws to 18 - 24 Nm (15 - 20 ft lb).

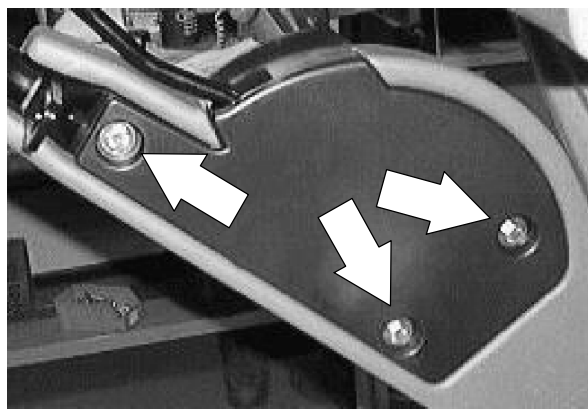

19. Move the handle assembly up to one of the four adjustment holes.

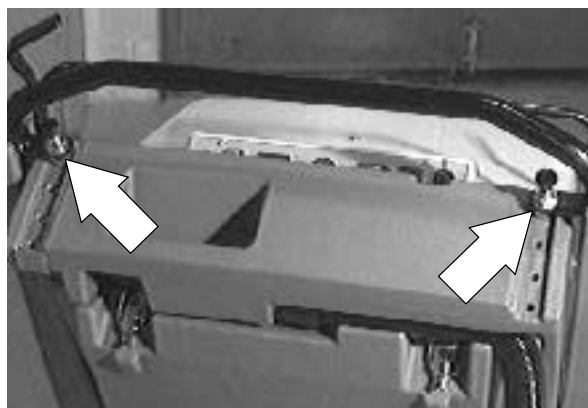

20. Reinstall the the handle stop bracket.

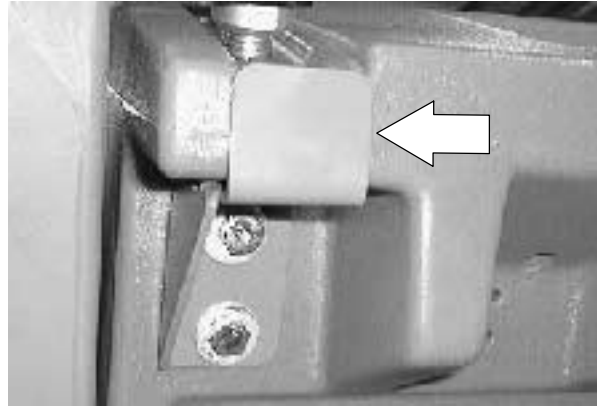

21. Reinstall the filter cover onto the rear of the machine.



22. Close the engine cover.



23. Start the machine and check the clutch bar for proper engagement. If the new cable needs to be adjusted, open the engine cover and loosen the two idler cable jam nuts. Move the cable or cable bracket up or down and re-tighten the jam nuts. Close the cover and re-check.

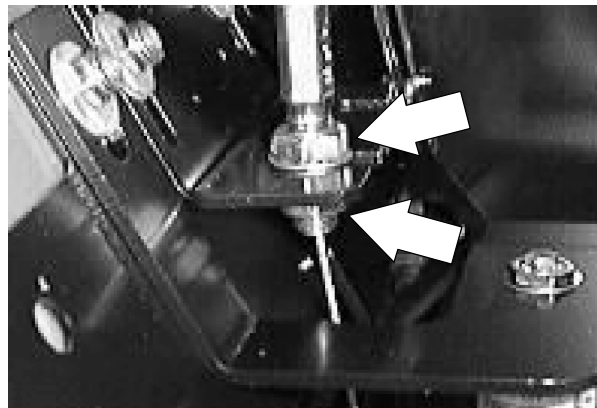

### TO REPLACE DRIVE BELT IDLER PULLEY

**FOR SAFETY: Before Leaving Or Servicing Machine; Stop On Level Surface, Place Shifter In Park.**

1. Open the engine cover and engage the prop rod.



2. Slip the drive belt off the transaxle sheave and idler pulley.

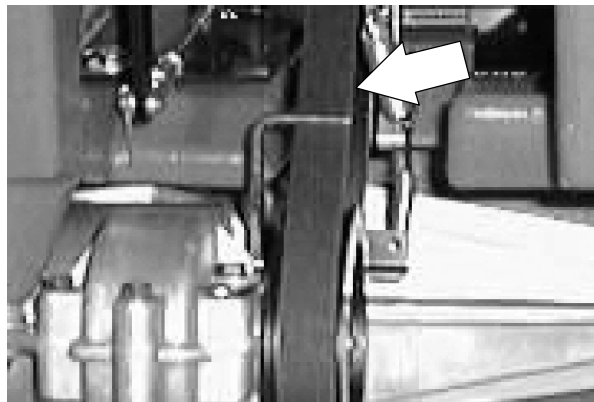

3. Remove the hex screw and nut holding the idler pulley to the idler arm. Remove the idler pulley. Retain the spring mount bracket.

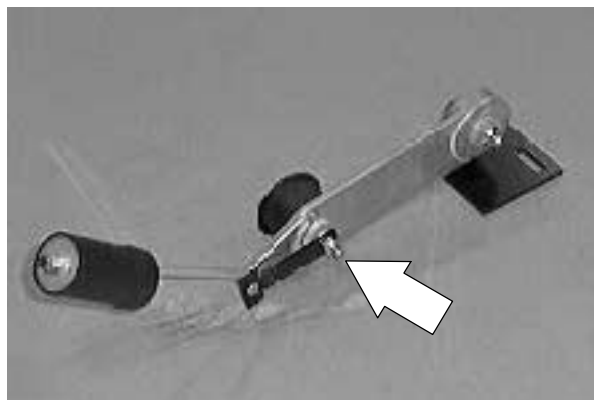



4. Install the new idler pulley on the idler arm. Make sure to reinstall the spring mount bracket. Tighten the hex screw and nut to 7.6 - 9.9 Nm (6 - 8 ft lb).

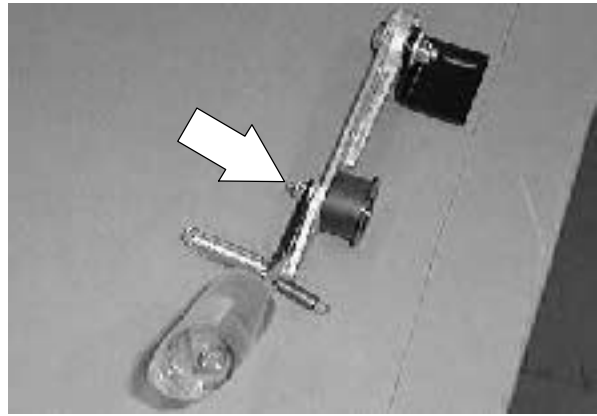

5. Slip the drive belt back over the transaxle sheave and the new idler pulley.

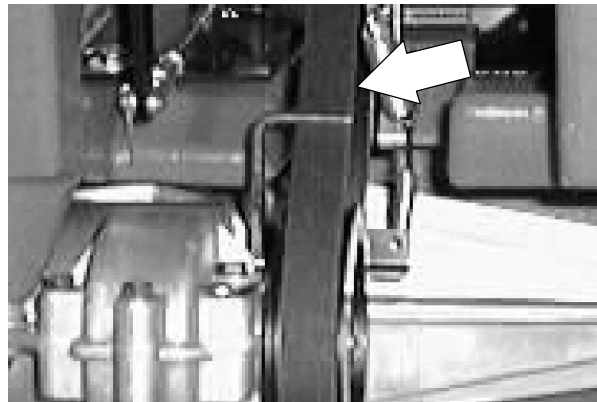

6. Lower the engine cover and operate the machine. Check the new idler for proper operation.





## CONTENTS

	Page		Page
INTRODUCTION .....	3-3	SKIRTS AND SEALS .....	3-54
DEBRIS HOPPER .....	3-4	HOPPER LIP SKIRT .....	3-54
TO REMOVE DEBRIS HOPPER .....	3-4	TO REPLACE HOPPER LIP	
TO INSTALL DEBRIS HOPPER .....	3-5	SKIRT .....	3-54
HOPPER DUMP ASSIST HANDLE ...	3-6	REAR SKIRT .....	3-56
THERMO SENTRY™ .....	3-7	TO REPLACE REAR SKIRT/	
TO REPLACE THERMO SENTRY™ ..	3-7	RECIRCULATION FLAP .....	3-56
VACUUM WAND .....	3-8	UPPER HOPPER SEAL .....	3-58
HOPPER DUST FILTER .....	3-9	TO REPLACE UPPER HOPPER	
TO REPLACE FILTER BAG		SEAL .....	3-58
(standard) .....	3-10	MAIN BRUSH DUST SEALS .....	3-60
TO REPLACE PANEL DUST FILTER		TO REPLACE LEFT BRUSH	
(optional) .....	3-12	SEAL (idler side) .....	3-60
MAIN BRUSH .....	3-14	TO REPLACE RIGHT BRUSH	
TO REPLACE MAIN BRUSH .....	3-14	SEAL (drive belt side) .....	3-63
TO CHECK AND ADJUST MAIN		VACUUM FAN .....	3-66
BRUSH PATTERN .....	3-17	TO REMOVE VACUUM FAN	
TO REPLACE MAIN BRUSH LIFT		ASSEMBLY .....	3-66
CABLE .....	3-18	TO INSTALL VACUUM FAN	
TO REPLACE MAIN BRUSH DRIVE		ASSEMBLY .....	3-68
BELT .....	3-24	TO REPLACE VACUUM FAN	
TO REPLACE MAIN BRUSH DRIVE		IMPELLER .....	3-71
BELT IDLER BEARINGS .....	3-27	TO REPLACE VACUUM FAN	
TO REPLACE MAIN BRUSH DRIVE		IMPELLER BEARINGS .....	3-73
SHEAVE .....	3-31	TO TENSION VACUUM FAN V-BELT	3-77
TO REPLACE STAINLESS STEEL		MACHINE TROUBLESHOOTING .....	3-79
BRUSH ARM WEAR RINGS ....	3-35		
TO REMOVE MAIN BRUSH SHAFT .	3-39		
TO INSTALL MAIN BRUSH SHAFT ..	3-41		
SIDE BRUSH .....	3-42		
TO REPLACE LH OR RH SIDE			
BRUSH .....	3-42		
TO REPLACE SIDE BRUSH LIFT			
CABLE .....	3-44		
TO REPLACE SIDE BRUSH			
HOUSING .....	3-50		



**INTRODUCTION**

This section includes information on the sweeping operation. The side brush sweeps debris in front of the machine and the main brush sweeps the debris into the hopper. The vacuum fan pulls air from the hopper and through the dust filter.

## DEBRIS HOPPER

The hopper holds the debris that the side and main brush sweep up. It is located on the front of the machine.



### TO REMOVE DEBRIS HOPPER

**FOR SAFETY: Before Leaving Or Servicing Machine; Stop On Level Surface, Place Shifter In Park.**

1. Go to the front of the machine and grasp the molded handle.
2. Lift on the handle and pull the hopper slightly up and forward.
3. Use your other hand to lift the front of the hopper.
4. Lift the hopper up and out of the machine frame.



**TO INSTALL DEBRIS HOPPER**

**FOR SAFETY: Before Leaving Or Servicing Machine; Stop On Level Surface, Place Shifter In Park.**

1. Position the hopper in the machine with the open end facing the main brush.

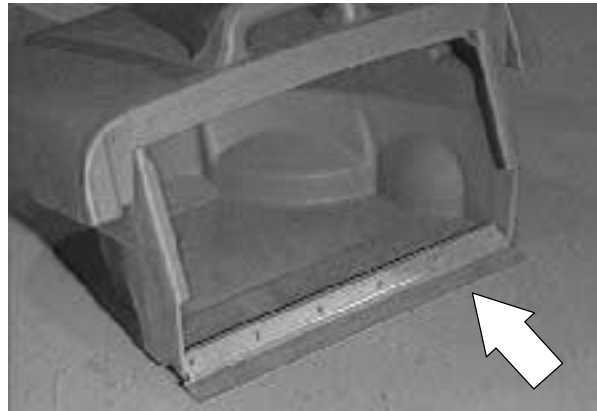

2. Let the hopper rest on the machine front frame rails.



3. Push the hopper back until the two frame knobs are lined up with the two indentations in the hopper. The hopper is now in its correct position.

## OPTIONS

### HOPPER DUMP ASSIST HANDLE

The dump assist handle allows easy removal and transport of the debris hopper when it is full.

Raise the dump assist handle.



Place one foot on the hopper's pivot point.



Lift the hopper out of the machine and onto the wheels. Transport the hopper to the location where debris is collected.

*NOTE: Do not attempt to lift the hopper when it is full of debris without assistance. Dump the debris from the hopper into a pile on the floor near a trash can or dumpster, then pick the debris up with a shovel.*





---

**THERMO SENTRY™**

---

The Thermo Sentry™ is used to shut down the airflow from the vacuum fan in the event of a hopper fire. The Thermo Sentry™ can be reset by pressing the red button on the end.

**TO REPLACE THERMO SENTRY™**

**FOR SAFETY: Before Leaving Or Servicing Machine; Stop On Level Surface, Place Shifter In Park.**

1. Open the cover and engage the prop rod.



2. Locate the Thermo Sentry™ on the back wall just above the filter shaker motor.

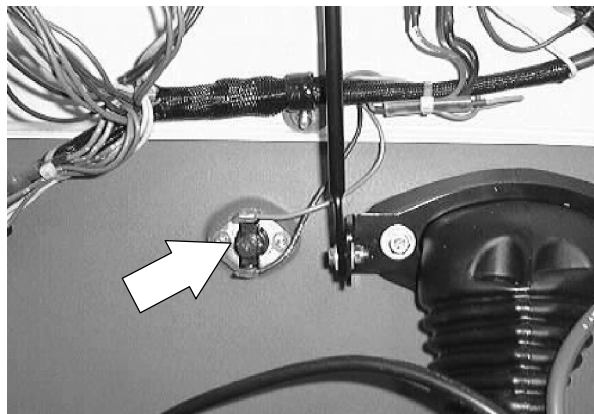

3. Disconnect the wire from the terminals on the Thermo Sentry™.

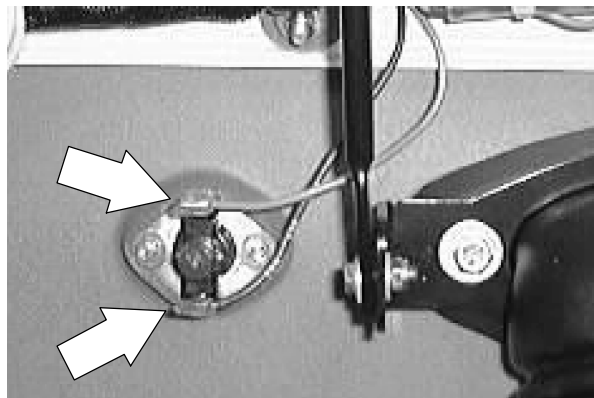

## SWEEPING

4. Remove the two self threading hex screws holding the Thermo Sentry™ to the panel. Remove the Thermo Sentry™.
5. Position the new Thermo Sentry™ on the panel. Reinstall the hardware and lightly hand tighten.

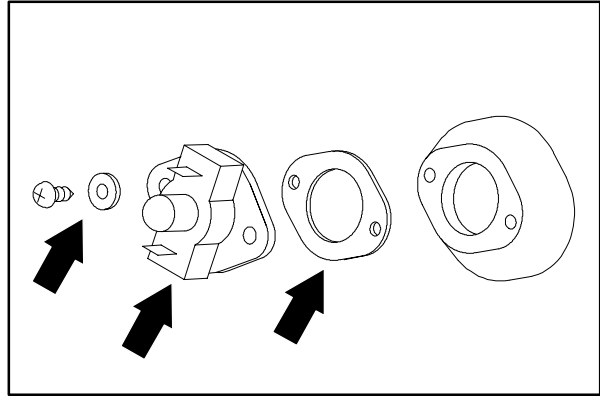

6. Reconnect the wires to the Thermo Sentry™. See schematic in the ELECTRICAL section.

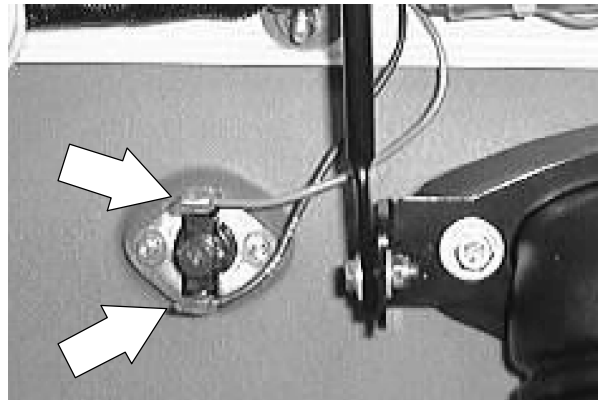

7. Close the cover.



## VACUUM WAND

The vacuum wand uses the machine's vacuum system. Use the vacuum wand to pick up debris in narrow or partially enclosed areas that cannot be swept by the machine.

*NOTE: The vacuum hose screws into the vacuum nozzle (left hand thread). Un-screw to replace the hose.*



---

**HOPPER DUST FILTER**

---

The hopper filter is located at the rear of the machine, behind the rear cover.

The standard filter is a bag style that is simply removed and discarded when full.

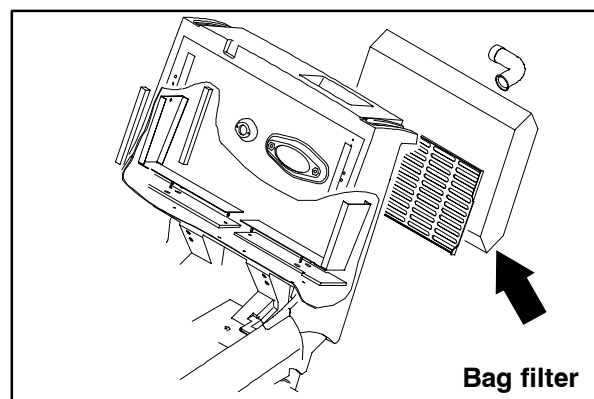

The optional filter is a panel style that can be cleaned and re-used multiple times. The optional filter also comes with a filter shaker system that can be used to shake the filter between cleanings.

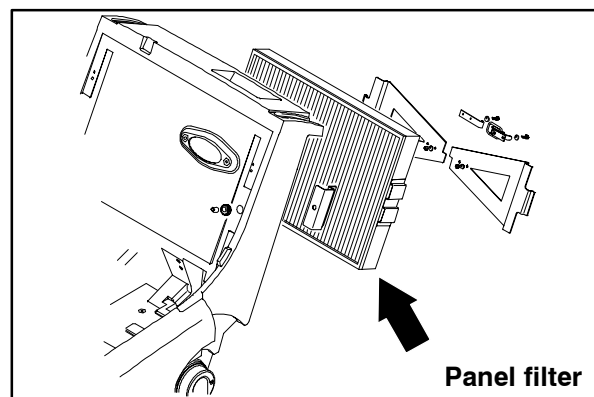

## SWEEPING

### TO REPLACE FILTER BAG (standard)

**FOR SAFETY: Before Leaving Or Servicing Machine; Stop On Level Surface, Place Shifter In Park.**

1. Go to the rear of the machine and un-snap the two filter cover clamps. Pull the vacuum wand out of the mount hole and hang it over the steering handle.

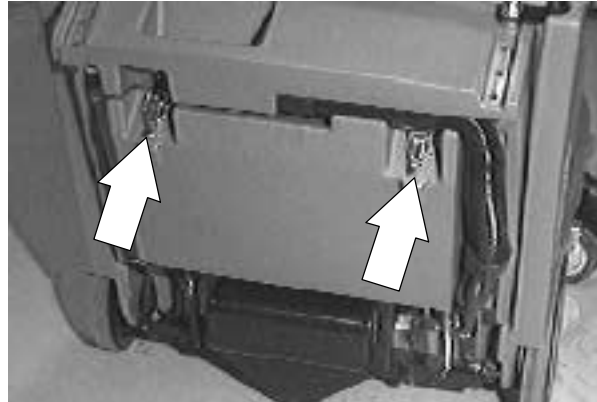

2. Let the filter cover pivot down until it stops.

*NOTE: Remove the filter cover to empty any dirt that has collected.*

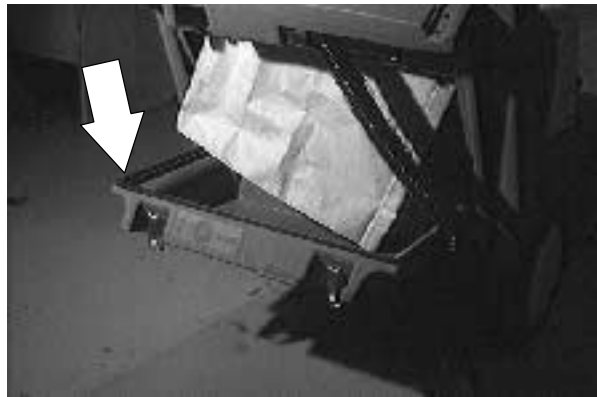

3. Pull the filter bag off the 90° air horn. Remove the filter bag from the machine.

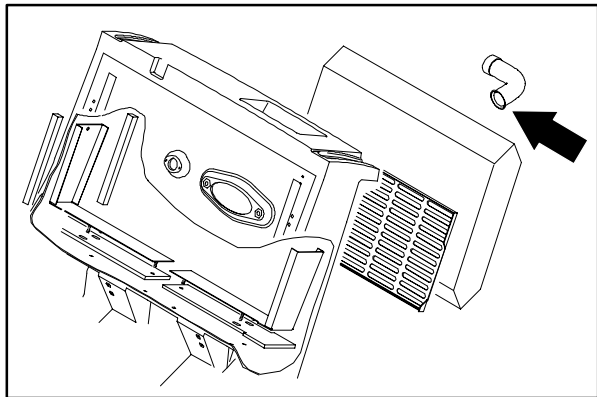

4. Position the new filter bag in the filter area. Place the hole in the bag over the end of the 90° air horn.

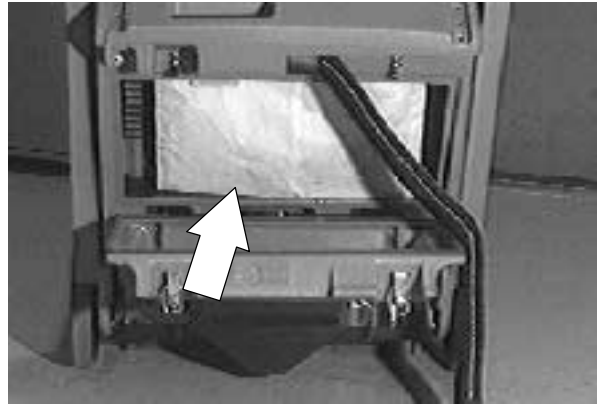

5. Pivot the filter cover into position. Make sure the upper portion of the vacuum wand hose is in the proper location.

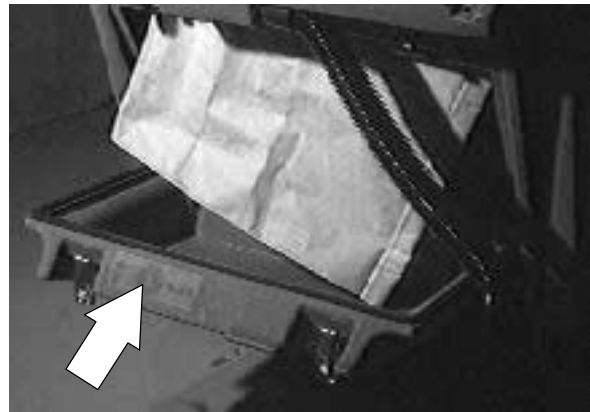

6. Reconnect the two filter clamps and snap them into the lock position. Reinstall the vacuum wand in the mount hole.

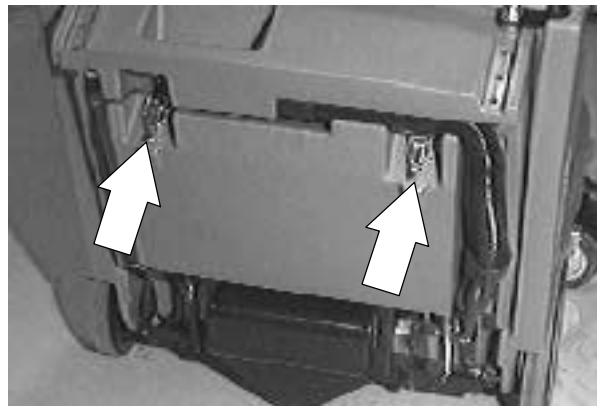

7. Start the machine and check the hopper filter area for any air leaks.

## SWEEPING

### TO REPLACE PANEL DUST FILTER (optional)

**FOR SAFETY: Before Leaving Or Servicing Machine; Stop On Level Surface, Place Shifter In Park.**

1. Go to the rear of the machine and un-snap the two filter cover clamps. Pull the vacuum wand out of the mount hole and hang it over the steering handle.

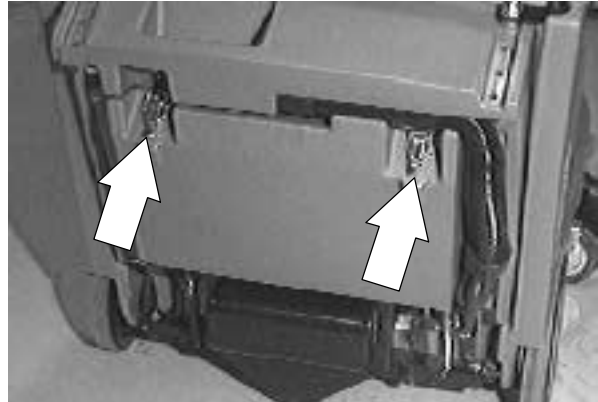

2. Let the filter cover pivot down until it stops.

*NOTE: Remove the filter cover to empty any dirt that has collected.*

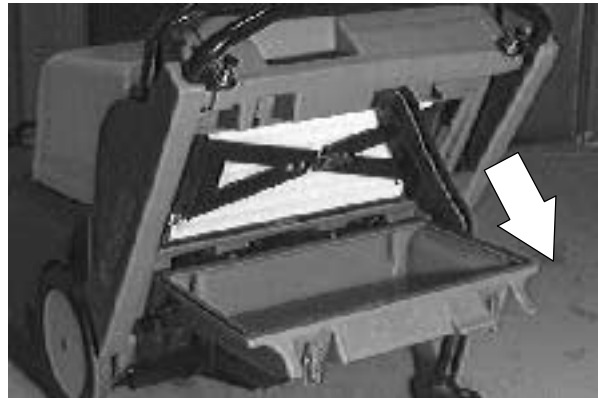

3. Un-snap the catch lock on the filter lock bars.

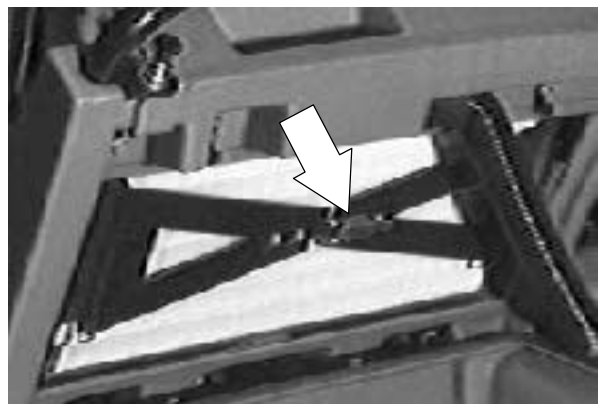

- Pivot the two filter lock bars back.

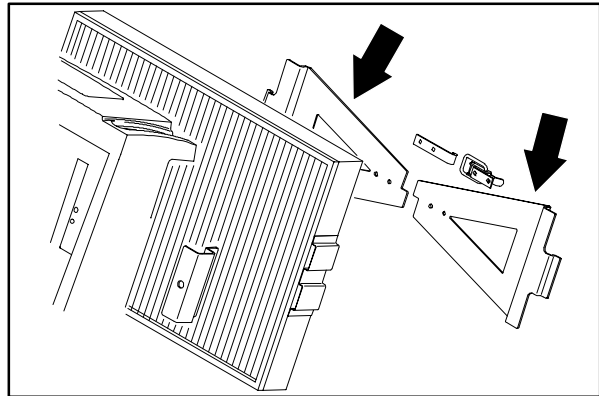

- Remove the old filter by grasping the tabs on both sides and pulling out. Pull the old filter down and out of the filter compartment.
- Position the new filter in the filter carrier. Make sure the air flow arrows point in toward the engine compartment.

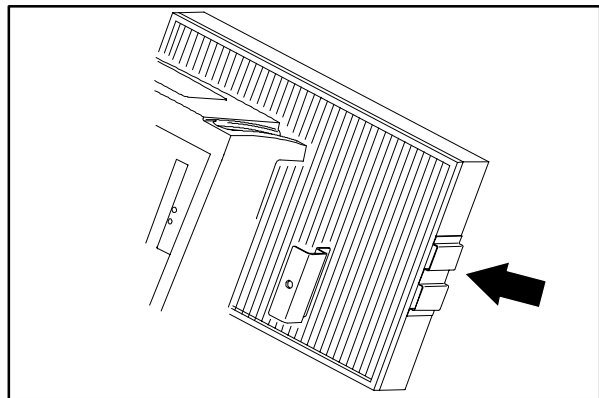

- Pivot the filter lock bars over the new filter and reconnect the catch lock.

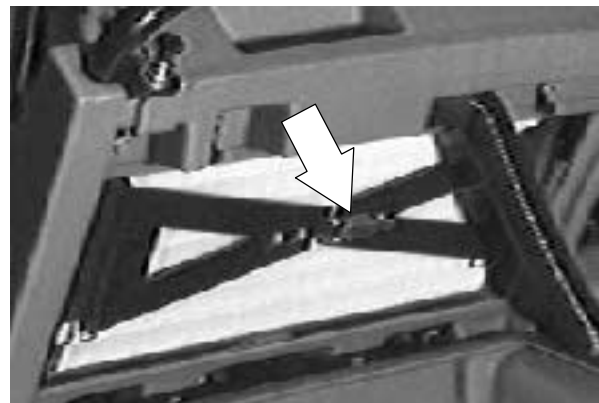

- Rotate the filter cover back into place. Make sure the upper portion of the vacuum wand hose is in the proper location.

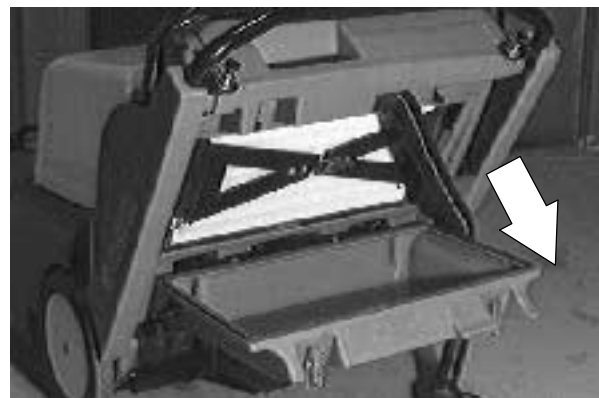

- Reconnect the two filter clamps and snap them into the lock position. Reinstall the vacuum wand in the mount hole.

- Start the machine and check the hopper filter area for any air leaks.

# SWEEPING

## MAIN BRUSH

The main brush is used to throw the debris into the hopper. The main brush can be rotated end for end to extend the life of the bristles.

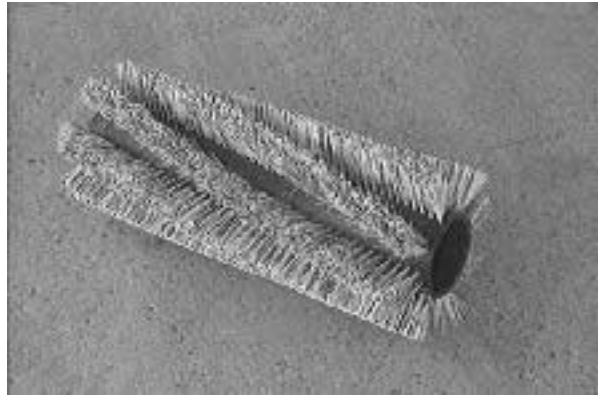

## TO REPLACE MAIN BRUSH

**FOR SAFETY: Before Leaving Or Servicing Machine; Stop On Level Surface, Place Shifter In Park.**

1. Remove the debris hopper from the machine and drop the main brush to the full float position.

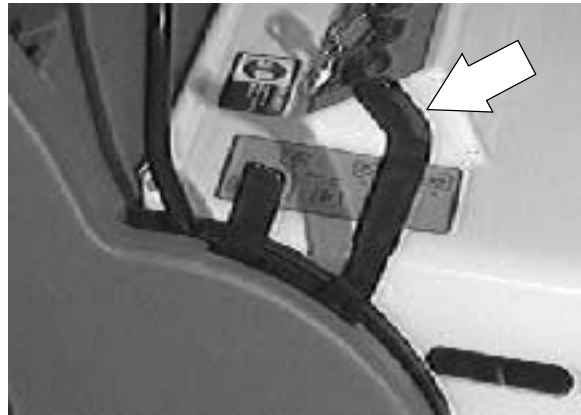

2. Go to the left side of the machine and locate the main brush idler side knob pin. This pin is located in the brush arm, just ahead of the LH drive wheel.





3. Push in on the knob pin and turn at the same time. Remove the pin from the brush arm.

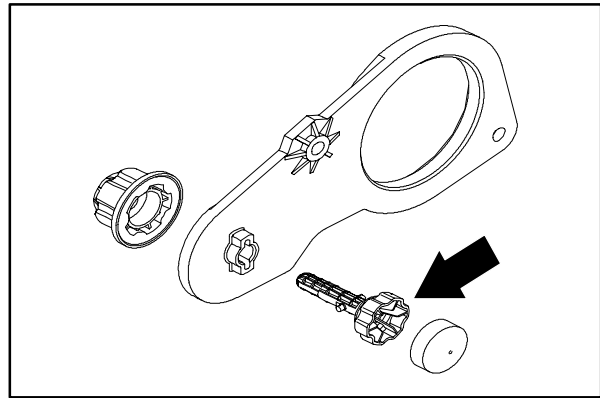

4. Remove the main brush from the machine by pulling the left side of the brush forward, then, pull the brush off the drive plug on the right side.

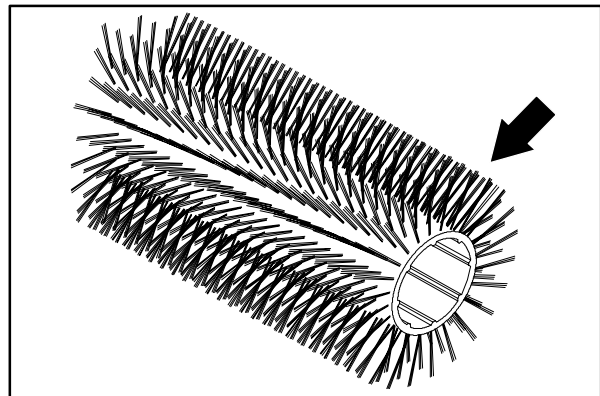

5. After the main brush has been removed from the machine, remove the bearing assembly from the idler side end of the brush.

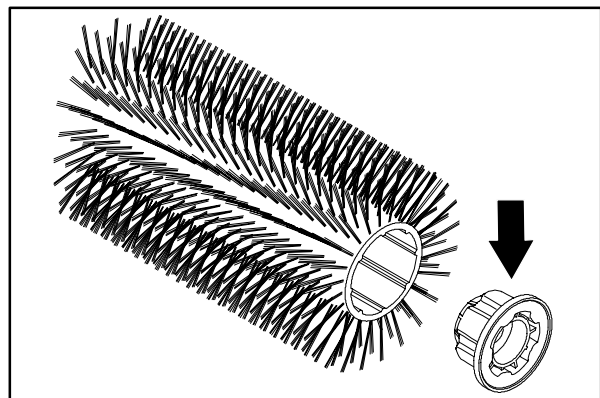

6. Install the bearing assembly in either end of the new brush.

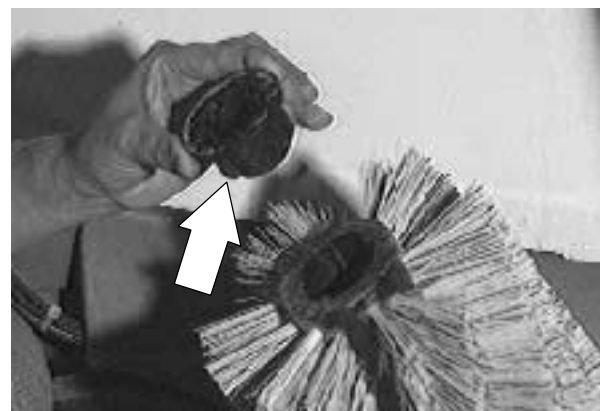

## SWEEPING

7. Position the new brush in the machine with the open end placed over the drive plug splines first, then, the end with the bearing assembly pushed into place.

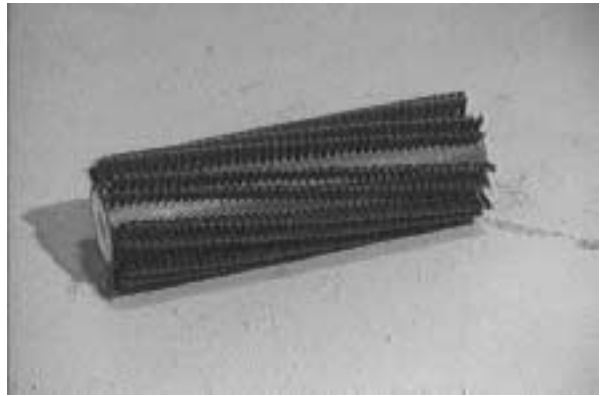

8. Reinstall the knob pin in the brush arm. Push the pin in until the two ribs on the pin line up with the two slots in the brush arm.

*NOTE: You may have to move the free end of the main brush around to help line up the pin and bearing.*

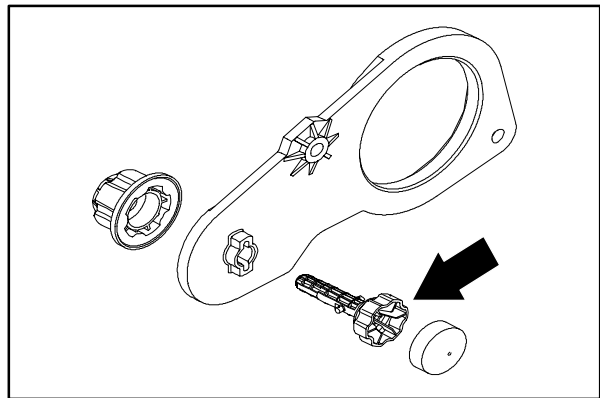

9. Push the pin in and turn it until it locks in position. A detent type lock should be felt.



10. Reinstall the debris hopper and operate the machine. Check the taper of the main brush and adjust if needed. See TO ADJUST MAIN BRUSH instructions.



## TO CHECK AND ADJUST MAIN BRUSH PATTERN

**FOR SAFETY: Before Leaving Or Servicing Machine; Stop On Level Surface, Place Shifter In Park.**

1. Find a level floor surface. Apply a coating of papier-mach'e to the floor.
2. Park the machine over the test area.
3. Start the machine and lower the brush. Run the brush for 1 minute. Raise the brush and turn off the machine. Move the machine off the test area.

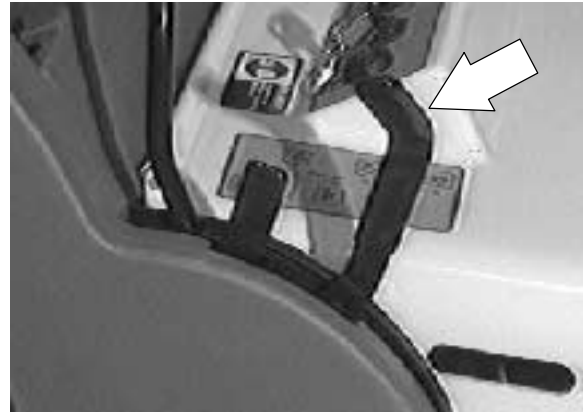

4. Check the pattern the main brush left on the floor. The brush pattern should be even all the way across. If the pattern is even--no adjustment is needed. If the brush pattern has any taper--go to the next step.

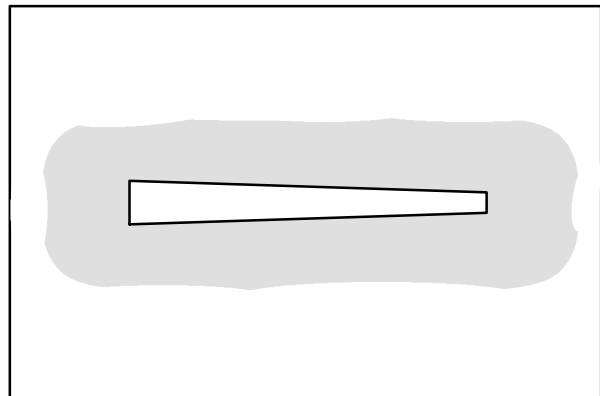

5. Go to the back of the machine and locate the left hand brush arm. Loosen the hex screw and nut holding the left brush arm to the brush shaft. Move the left brush arm up or down in the slot to achieve an even brush pattern. Re-tighten the hardware to 18 - 24Nm (15 - 20 ft lb).

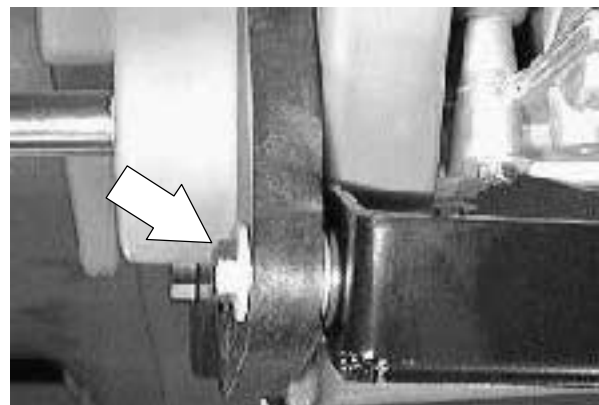

6. Follow steps 1 thru 4 to re-check the brush pattern.

## SWEEPING

### TO REPLACE MAIN BRUSH LIFT CABLE

**FOR SAFETY: Before Leaving Or Servicing Machine; Stop On Level Surface, Place Shifter In Park.**

1. Remove the filter cover from the rear of the machine. Remove the handle stop bracket from the upper/left side of the filter compartment.

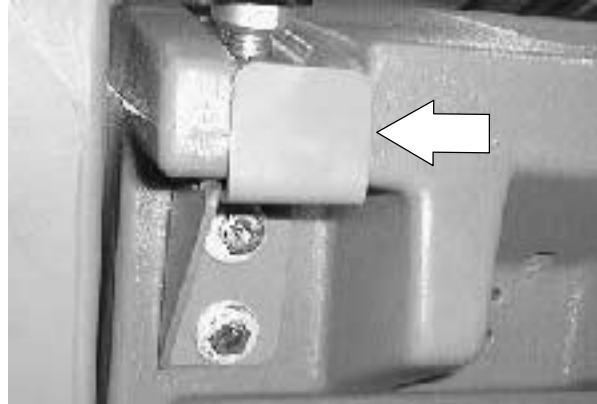

2. Pull up on the two handle locks and move the handle assembly to its lowest position.

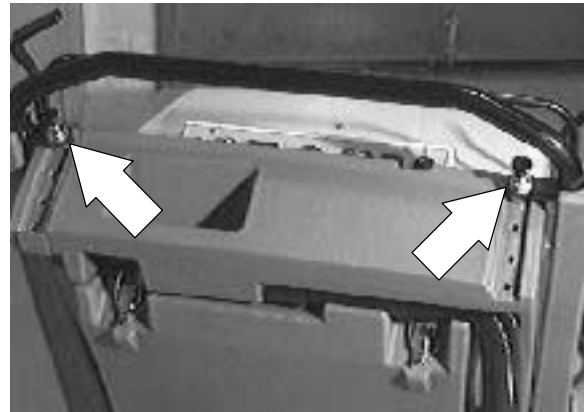

3. Remove the three hex screws holding the cover plate to the inside of the right side handle tower. Remove the cover plate from the machine.

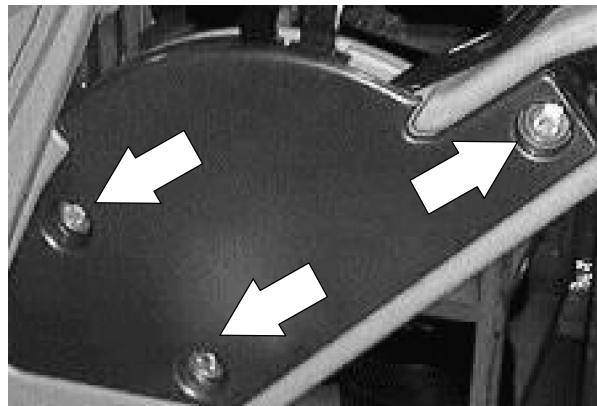

4. Remove the bolt and sleeve that holds the clutch bar to the plastic side arm. This will allow the pivot plate and handle assembly to tip out for better access.

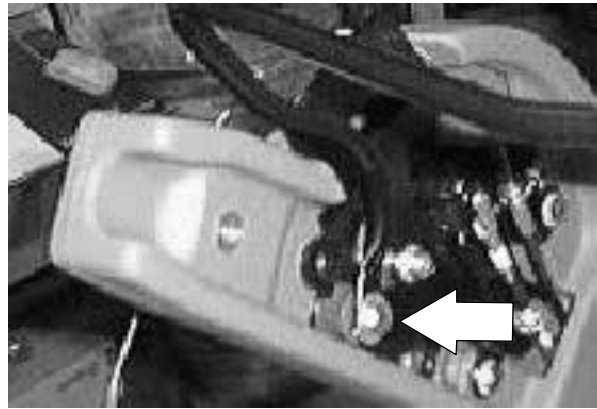

5. Remove the cotter pin and clevis pin from the end of the main brush lift cable where it attaches to the main brush lift lever.

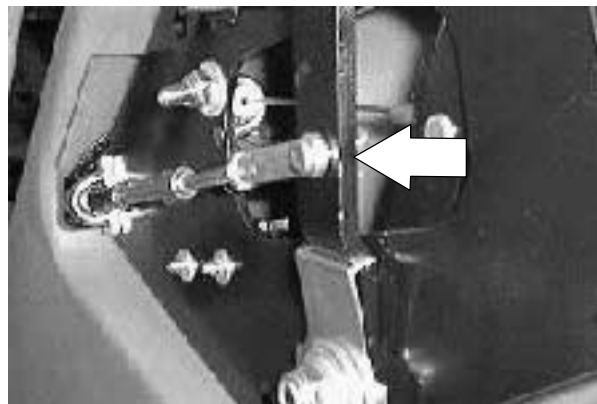

6. Remove the nut from the clamp holding the main brush cable to the mount plate.



7. Open the engine cover and locate the end of the main brush lift cable where it attaches to the mount bracket below the vacuum fan. Remove the cotter pin and clevis pin from the lift cable and brush lift arm.

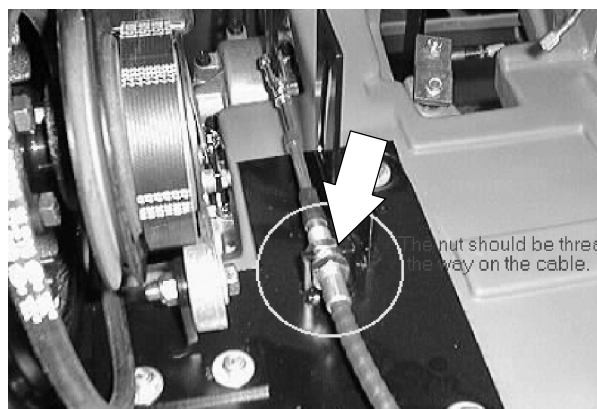

## SWEEPING

8. Loosen the two jam nuts on the lift cable where it attaches to the mount bracket. Slip the lift cable out of the mount slot.

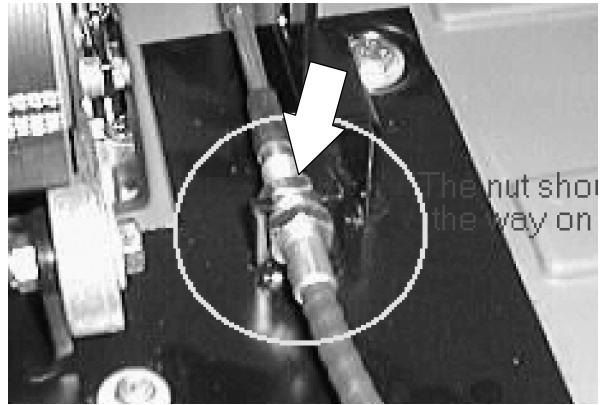

9. Remove the cotter pin and clevis pin where the main brush lift cable attaches to the brush lift weldment.

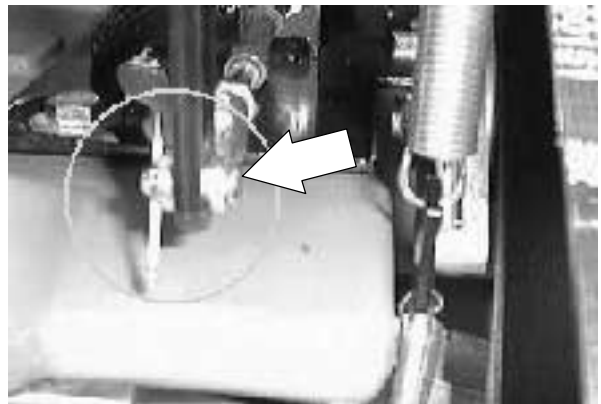

10. Pull the old main brush lift cable out of the machine from the lower end by the vacuum fan.

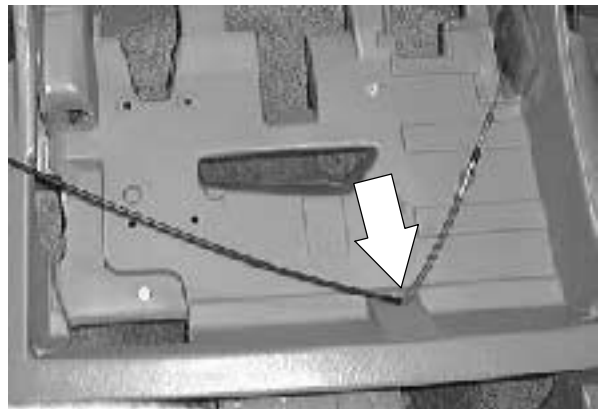

11. Route the new lift cable through the hole in the front, center of the frame. Push the cable toward the front, right corner. Next, reach into the corner finger hole to guide the cable to the rear of the machine frame and up into the side arm and the lift handle.

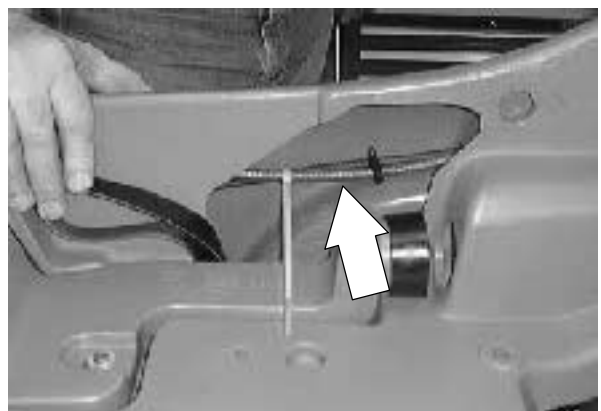

*NOTE: Add a cable tie around the new main brush lift cable and the existing side brush lift cable. This will prevent the side brush lift cable from drooping down and rubbing on the brush drive pulley.*

12. Remove the clevis and jam nut from both ends of the old cable and install on the new lift cable in the same position and orientation.

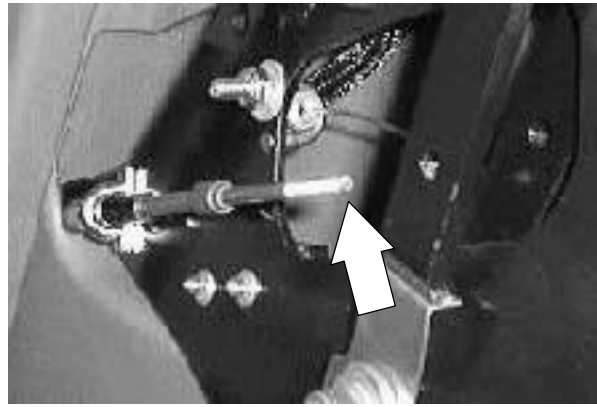

13. Position the new cable in the lower mount slot and tighten the jam nuts.

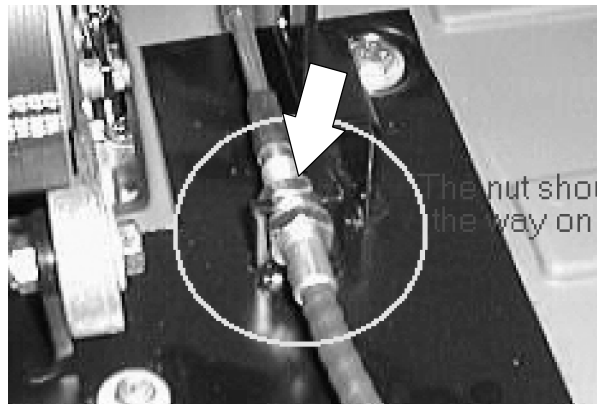

14. Install the clevis pin and cotter pin in the end of the new cable where it attaches to the main brush lift arm.

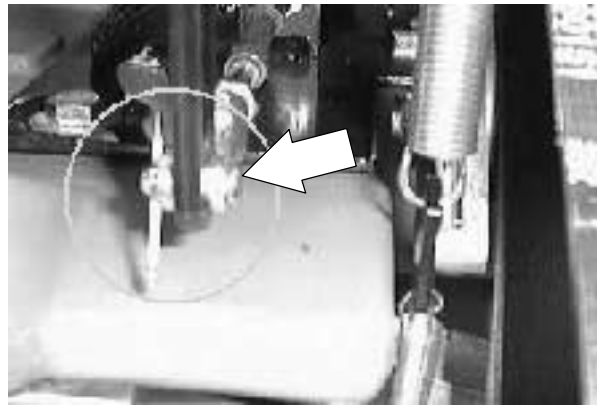

15. Go up to the main brush lift lever and install the nut on the main brush lift cable mount clamp. Tighten the nut to 7.6 - 9.9 Nm (6 - 8 ft lb).

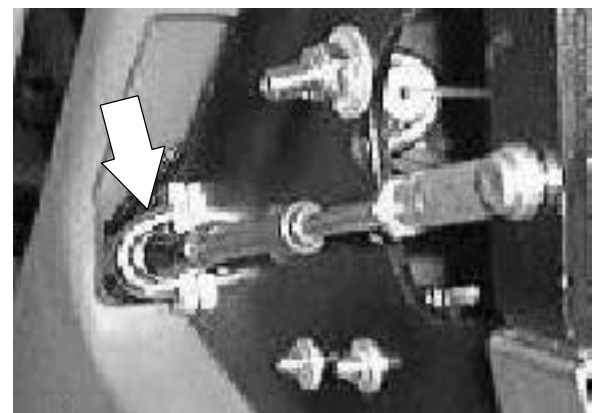

## SWEEPING

16. Install the clevis pin and cotter pin in the end of the new cable where it attaches to the main brush lift lever.

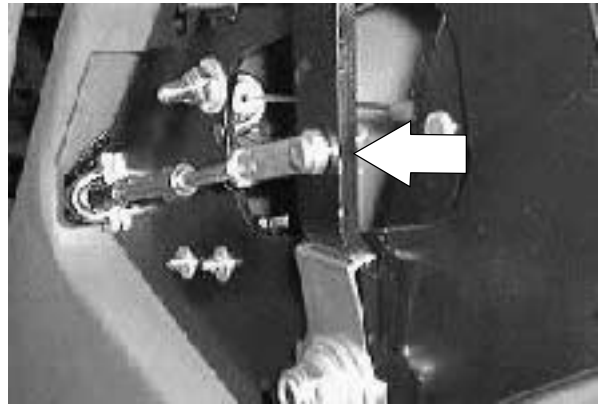

17. Reinstall the pivot plate assembly and clutch bar pivot.

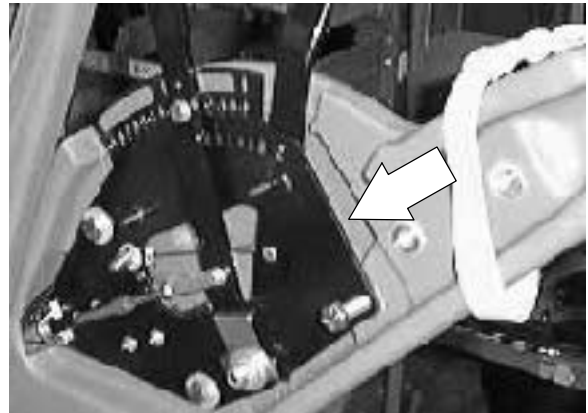

18. Reinstall the right side handle assembly cover plate. Tighten the three hex screws to 18 - 24 Nm (15 - 20 ft lb).

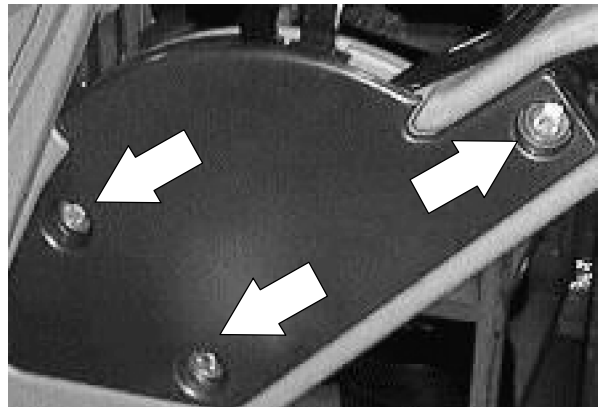

19. Move the handle assembly up to one of the four adjustment holes.

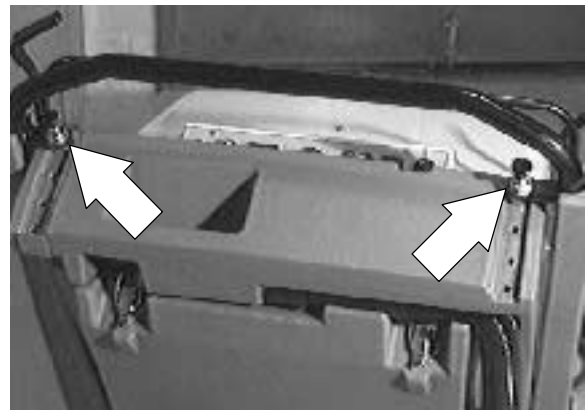



20. Reinstall the filter cover and the handle stop bracket.
21. Start the machine and check the main brush lift cable for proper operation. If the main brush cable needs to be adjusted, loosen the two jam nuts at the lower mount bracket, move the cable forward or backward, and re-tighten the jam nuts.

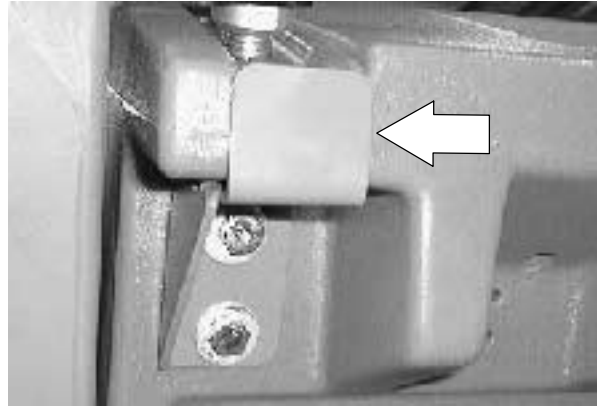

22. Close the engine cover.



## SWEEPING

### TO REPLACE MAIN BRUSH DRIVE BELT

**FOR SAFETY: Before Leaving Or Servicing Machine; Stop On Level Surface, Place Shifter In Park.**

1. Remove the main brush. See TO REPLACE MAIN BRUSH instructions.

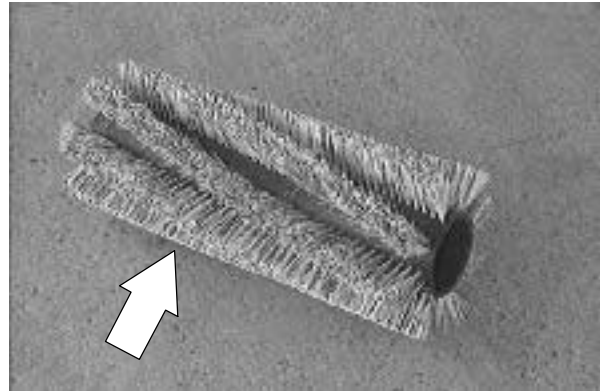

2. Raise the right side of the machine and install a block under the frame.



3. Remove the flat head screw holding the hub cap and drive wheel to the axle. Pull the tire and wheel assembly off the drive axle. Be careful not to loose pin from axle cross hole.

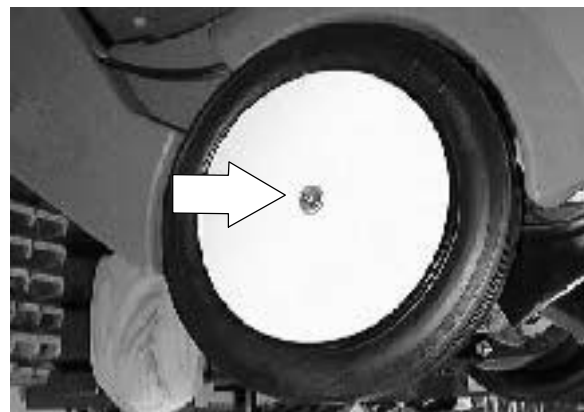

- Place the main brush lift lever in the down position. Remove the retainer plate covering the belt drive.

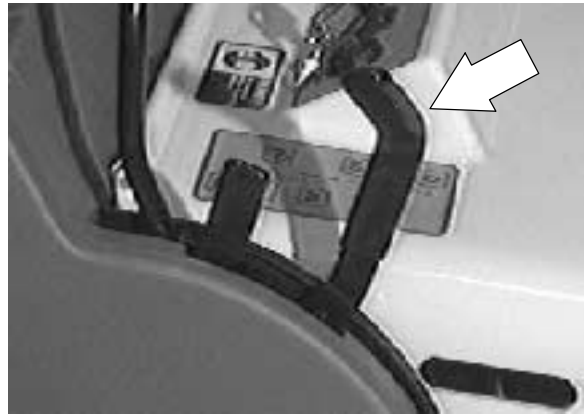

- Place a screw driver in the 1/4 in. hole in the brush arm behind the idler arm. **Place the main brush lift lever in the up position.** The screw driver will hold the idler from moving and tension on the brush belt will be released.

*NOTE: The pressure on the belt tensioner must be released before the drive belt can be replaced.*

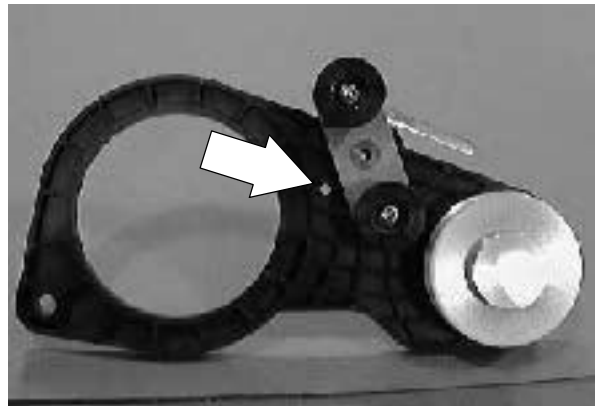

- Remove the old brush belt from the engine sheave, belt tensioner sheaves, and main brush drive plug sheave. Remove the drive belt from the machine.

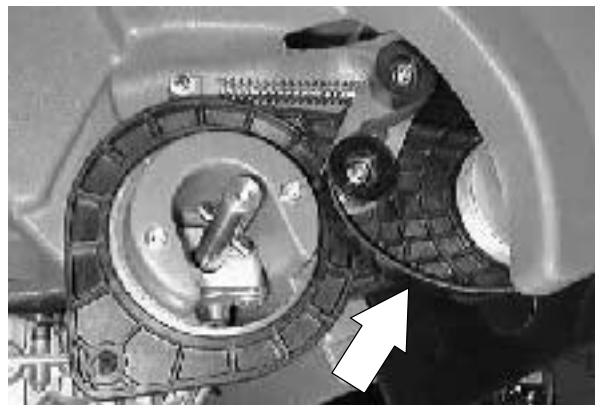

- Position the new drive belt in the machine. First, loop it over the engine sheave, then, over the main brush drive plug sheave, then, the idler sheaves.

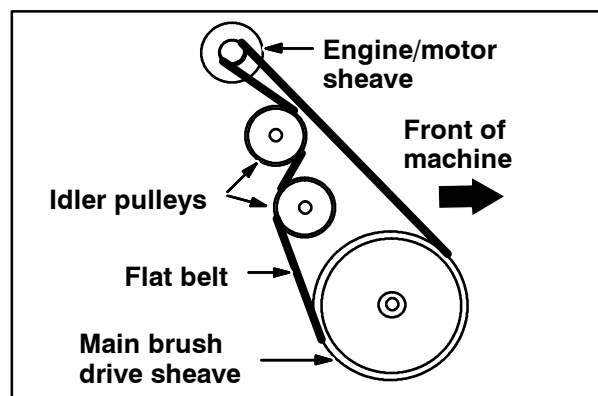

## SWEEPING

- Place the main brush lift lever in the down position.

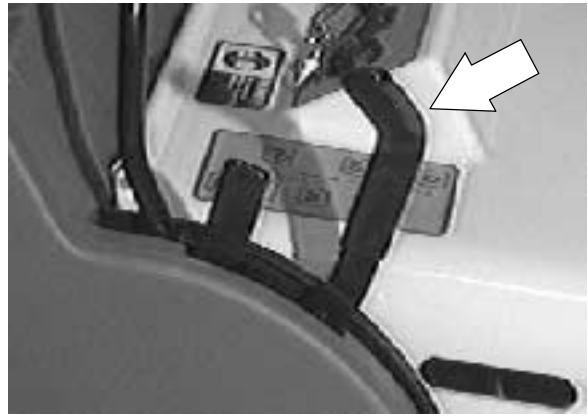

- Remove the screw driver from the brush arm. Place the main brush lift lever in the up position. Reinstall the belt drive plate.



- Reinstall the right side drive wheel and hub cap. Tighten the flat screw to 7.6 - 9.9 Nm (6 - 8 ft lb).

*NOTE: Place machine in Neutral, then, rotate axle until cross pin is horizontal. Put machine in Park and install hub/wheel assembly.*



- Install the main brush. See TO REPLACE MAIN BRUSH instructions. Lower the machine and operate the main brush. Check for proper operation.

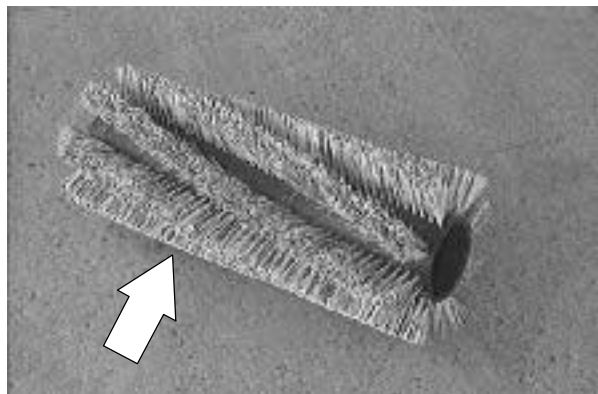

**TO REPLACE MAIN BRUSH DRIVE BELT IDLER BEARINGS**

**FOR SAFETY: Before Leaving Or Servicing Machine; Stop On Level Surface, Place Shifter In Park.**

1. Remove the main brush. See TO REPLACE MAIN BRUSH instructions.

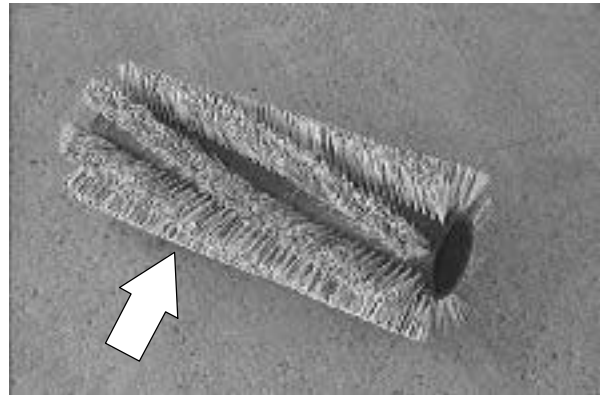

2. Raise the right side of the machine and install a block under the frame.



3. Remove the flat head screw holding the hub cap and drive wheel to the axle. Pull the tire and wheel assembly off the drive axle. Be careful not to loose pin from axle cross hole.

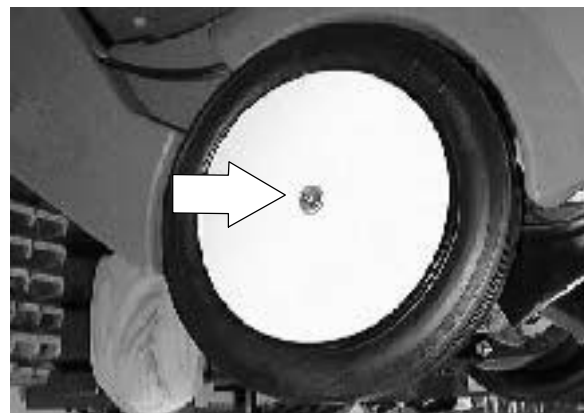

## SWEEPING

4. Place the main brush lift lever in the down position. Remove the retainer plate covering the belt drive.

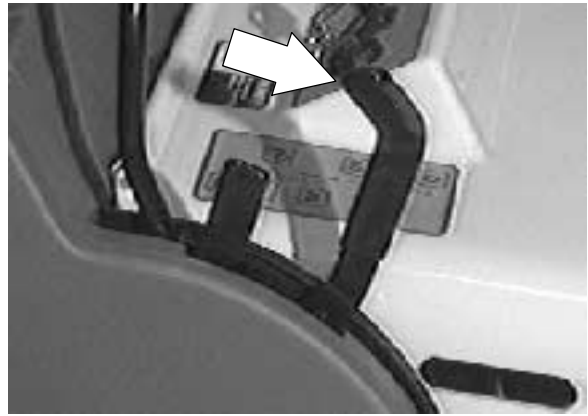

5. Place a screw driver in the 1/4 in. hole in the brush arm behind the idler arm. **Place the main brush lift lever in the up position.** The screw driver will hold the idler from moving and tension on the brush belt will be released.

*NOTE: The pressure on the belt tensioner must be released before the drive belt can be replaced.*



6. Remove the old brush belt from the engine sheave, belt tensioner sheaves, and main brush drive plug sheave.

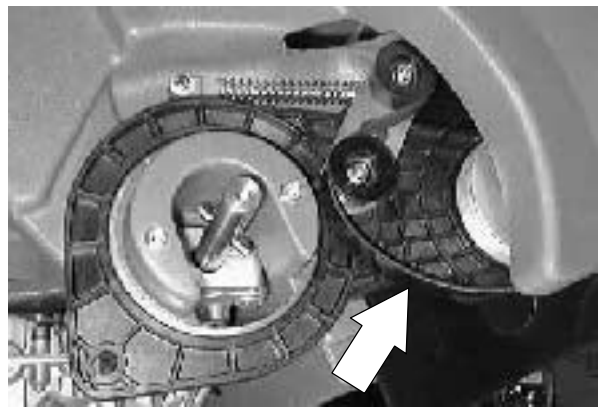

7. Remove the hex nut or hex screw holding the idler pulley to the idler arm. Remove the idler pulley from the machine.

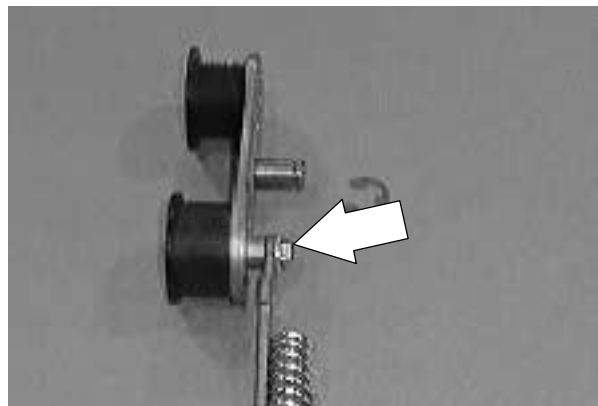

8. Install the new pulley on the brush arm and tighten the hardware to 7.6 – 9.9 Nm (6 – 8 ft lb).

*NOTE: Make sure to install the correct idler pulley (grooved or smooth).*

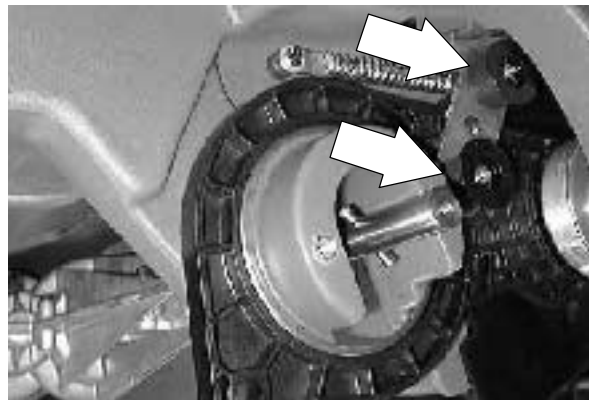

9. Reinstall the main brush drive belt.

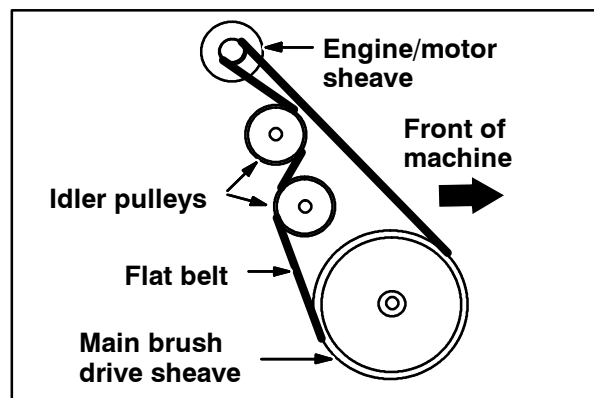

10. Place the main brush lift lever in the down position.

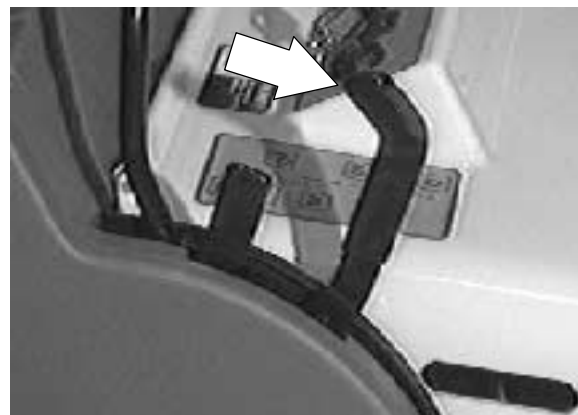

11. Remove the screw driver from the brush arm. Place the main brush lift lever in the up position. Reinstall the belt drive plate.

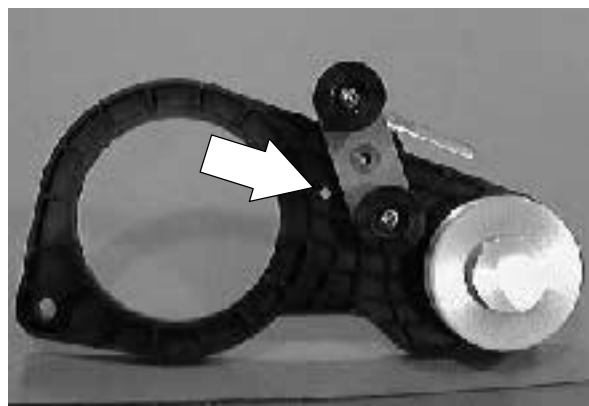

## SWEEPING

12. Reinstall the right side drive wheel and hub cap. Tighten the flat screw to 7.6 - 9.9 Nm (6 - 8 ft lb).

*NOTE: Place machine in Neutral, then, rotate axle until cross pin is horizontal. Put machine in Park and install hub/wheel assembly.*



13. Install the main brush. See TO REPLACE MAIN BRUSH instructions.

14. Lower the machine and operate the main brush. Check for proper operation.

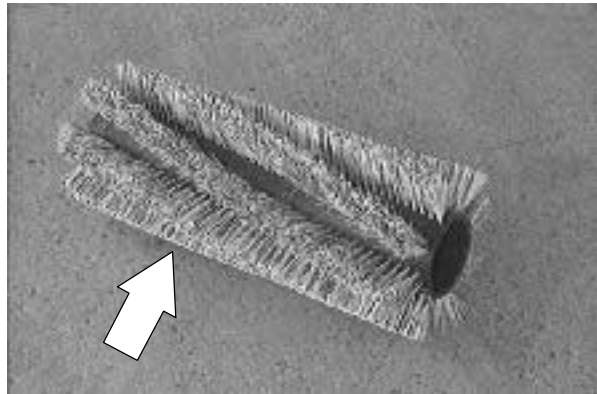



**TO REPLACE MAIN BRUSH DRIVE SHEAVE**

**FOR SAFETY: Before Leaving Or Servicing Machine; Stop On Level Surface, Place Shifter In Park.**

1. Remove the main brush. See TO REPLACE MAIN BRUSH instructions.

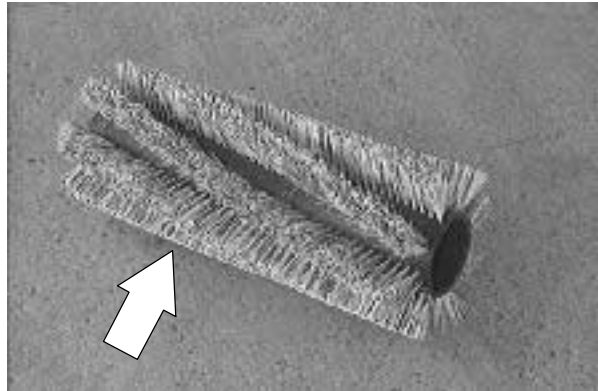

2. Raise the right side of the machine and install a block under the frame.



3. Remove the flat head screw holding the hub cap and drive wheel to the axle. Pull the tire and wheel assembly off the drive axle. Be careful not to loose pin from axle cross hole.

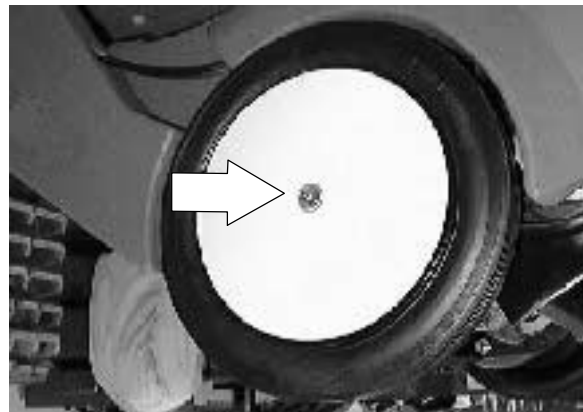

## SWEEPING

4. Place the main brush lift lever in the down position. Remove the retainer plate covering the belt drive.

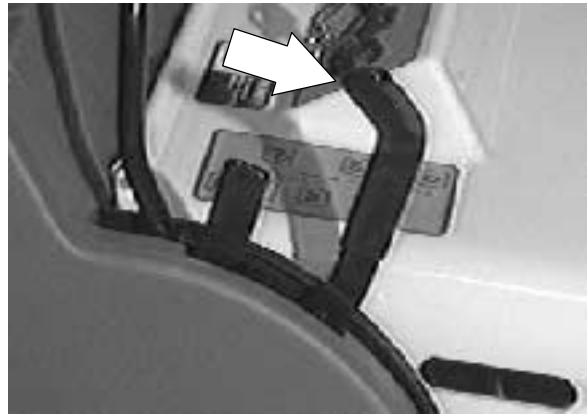

5. Place a screw driver in the 1/4 in. hole in the brush arm behind the idler arm. **Place the main brush lift lever in the up position.** The screw driver will hold the idler from moving and tension on the brush belt will be released.

*NOTE: The pressure on the belt tensioner must be released before the drive belt can be replaced.*



6. Remove the brush belt from the engine sheave, belt tensioner sheaves, and main brush drive plug sheave.

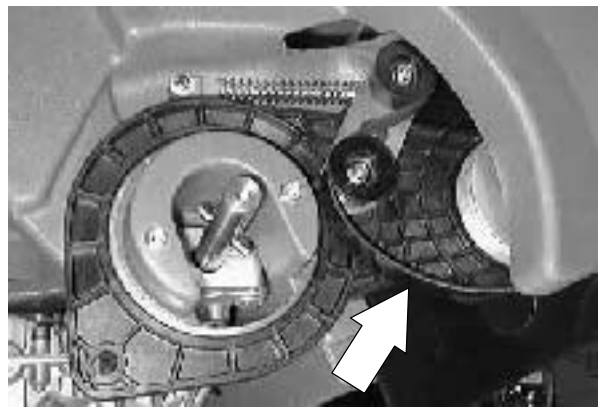

7. Remove the screw holding the brush drive plug to the pulley shaft. Remove the drive plug and square key.

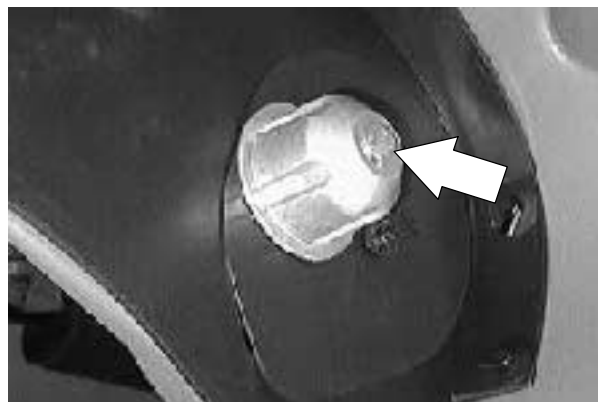

8. Press the sheave and shaft out of the brush arm.



9. Press the new sheave and shaft into the brush arm.

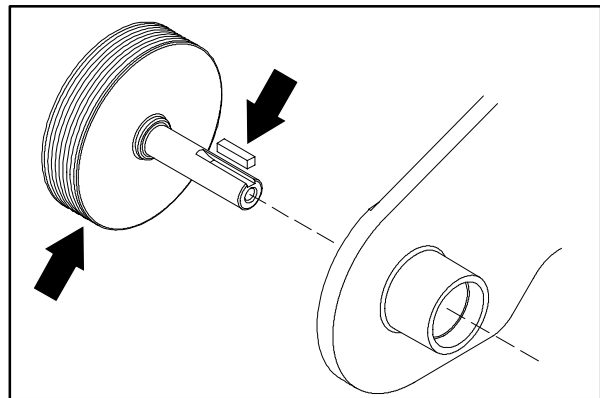

10. Reinstall the square key and drive plug on the shaft. Reinstall the screw and tighten to 7.6 - 9.9 Nm (6 - 8 ft lb).

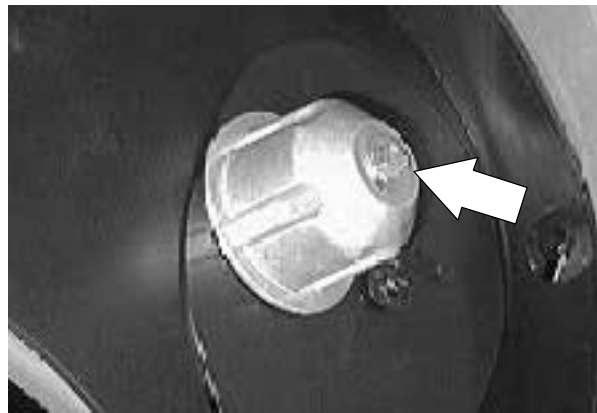

11. Reinstall the main brush drive belt.

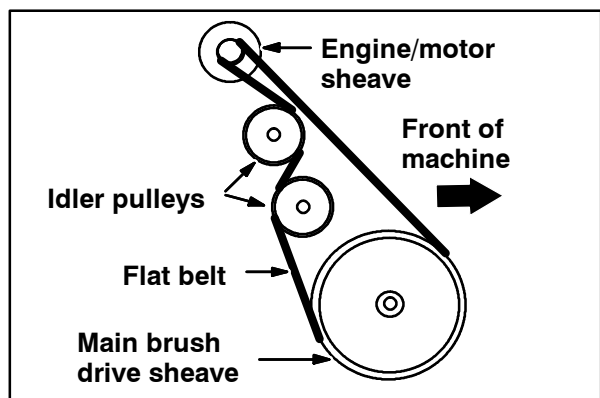

## SWEEPING

12. Place the main brush lift lever in the down position.

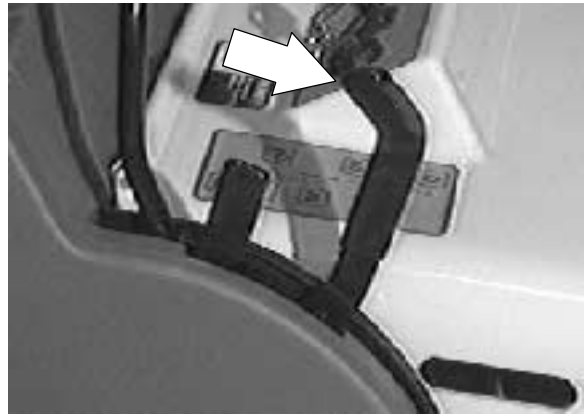

13. Remove the screw driver from the brush arm. Place the main brush lift lever in the up position. Reinstall the belt drive plate.

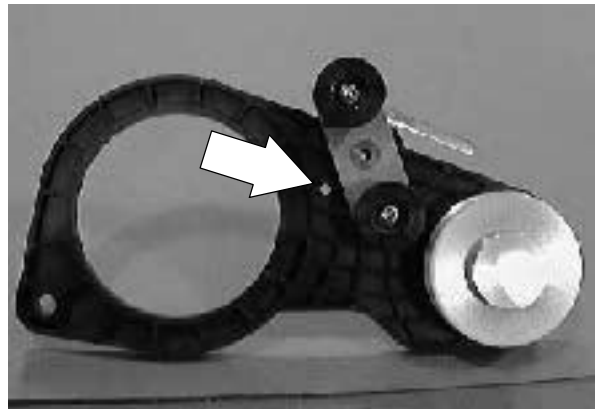

14. Reinstall the right side drive wheel and hub cap. Tighten the flat screw to 7.6 - 9.9 Nm (6 - 8 ft lb).

*NOTE: Place machine in Neutral, then, rotate axle until cross pin is horizontal. Put machine in Park and install hub/wheel assembly.*



15. Install the main brush. See TO REPLACE MAIN BRUSH instructions.

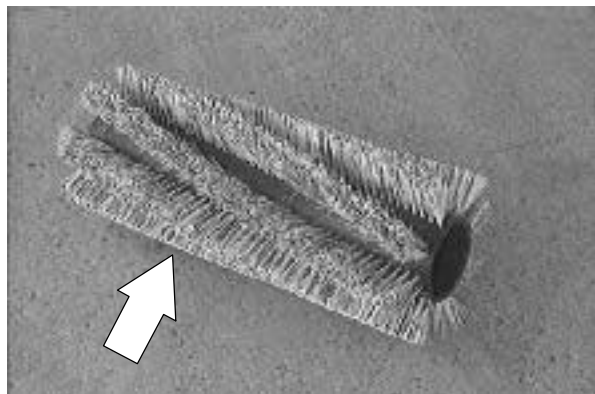

16. Lower the machine and operate the main brush. Check for proper operation.

**TO REPLACE STAINLESS STEEL BRUSH ARM WEAR RINGS**

**FOR SAFETY: Before Leaving Or Servicing Machine; Stop On Level Surface, Place Shifter In Park.**

1. Remove the main brush. See TO REPLACE MAIN BRUSH instructions.

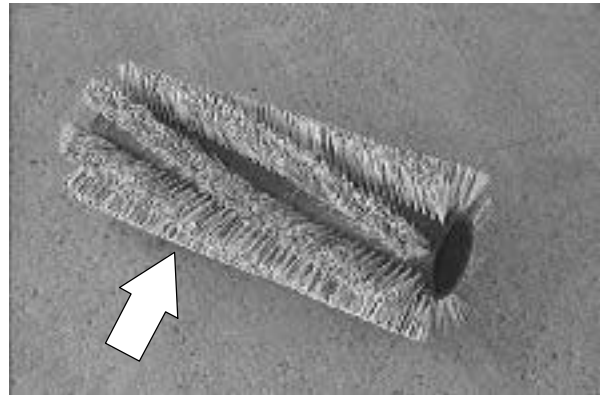

2. Remove both rear tires. See TO REMOVE REAR TIRE instructions in the CHASSIS section.

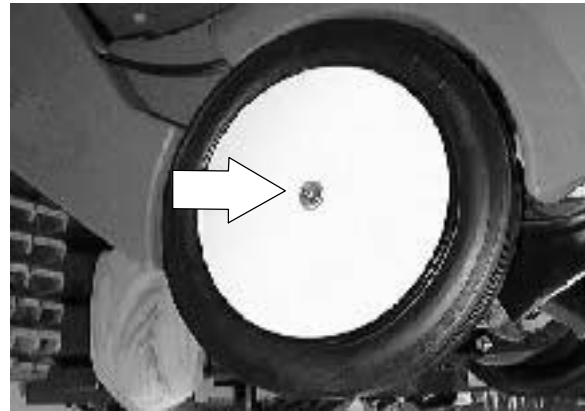

3. Remove the hex screw, sleeve, and nut holding the brush shaft to both brush arms.

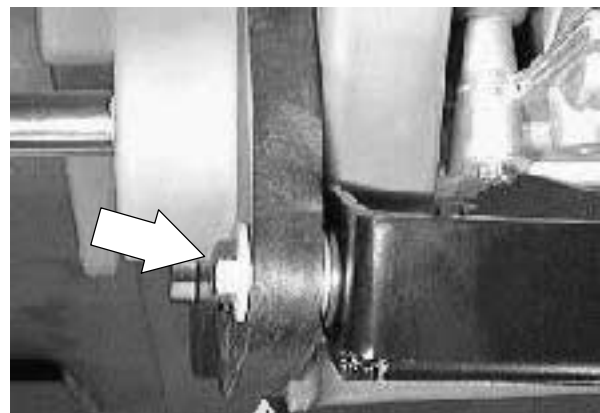

## SWEEPING

4. Remove the screws holding the brush arm retaining plates to the machine frame. Remove the retaining plates.

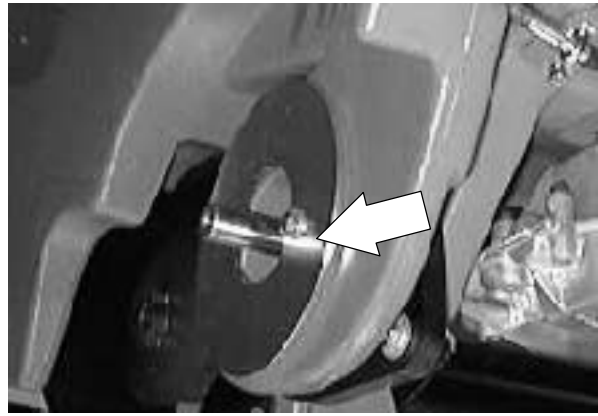

5. Spread the handle legs out far enough to drop them down past the end of the transaxle shafts.

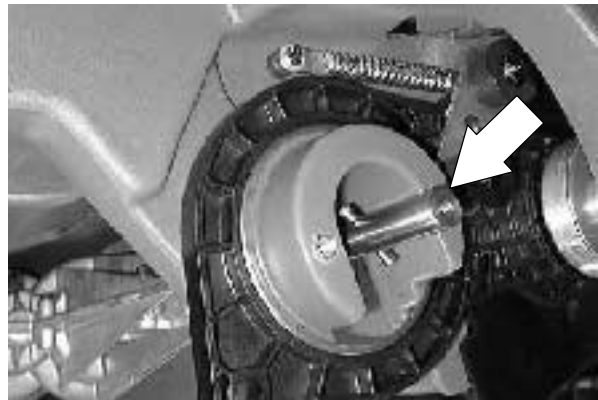

6. **LH BRUSH ARM:** Remove the left brush arm from the machine frame. Check the stainless steel wear ring. The wear ring can now be replaced or cleaned. If the wear ring is loose--use RTV sealant between the ring and the frame. Reinstall the left brush arm.

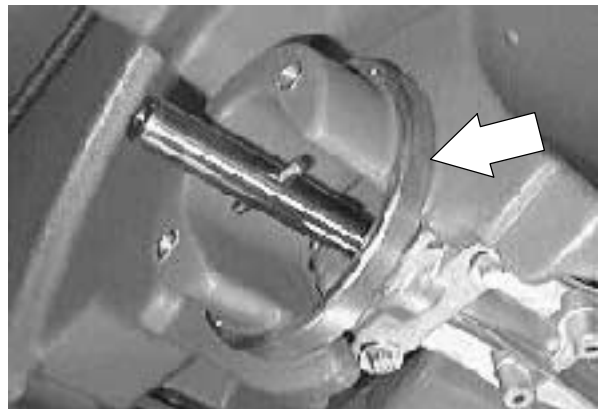

7. **RH BRUSH ARM:** Place a screw driver in the 1/4 in. hole in the brush arm behind the idler arm. Place the main brush lift lever in the up position. The screw driver will hold the idler from moving and tension on the brush belt will be released. Remove the main brush drive belt from the idler pulleys. Remove the right brush arm from the machine. The wear ring can now be replaced or cleaned. If the wear ring is loose--use RTV sealant between the ring and the frame. Reinstall the right brush arm.



8. Reinstall the main brush drive belt.

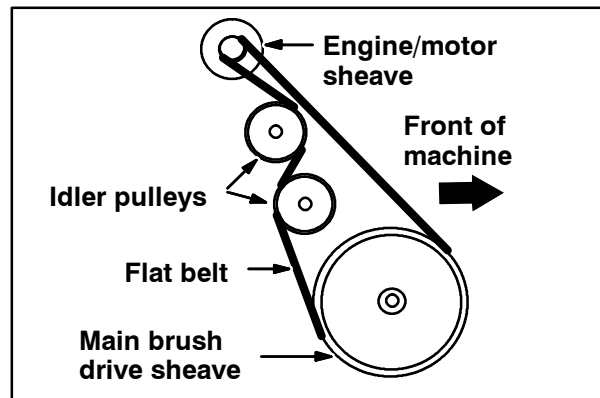

9. Place the main brush lift lever in the down position.

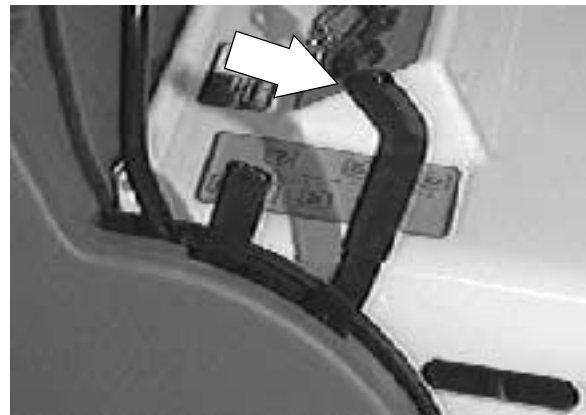

10. Remove the screw driver from the RH brush arm. Place the main brush lift lever in the up position. Reinstall the belt drive plate.

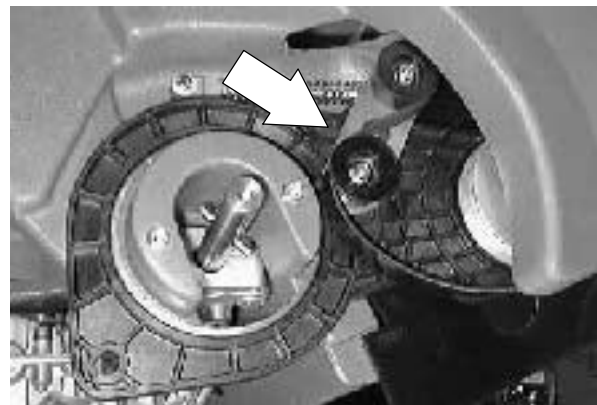

11. Spread the handle legs out far enough to reinstall them up past the end of the transaxle shafts.

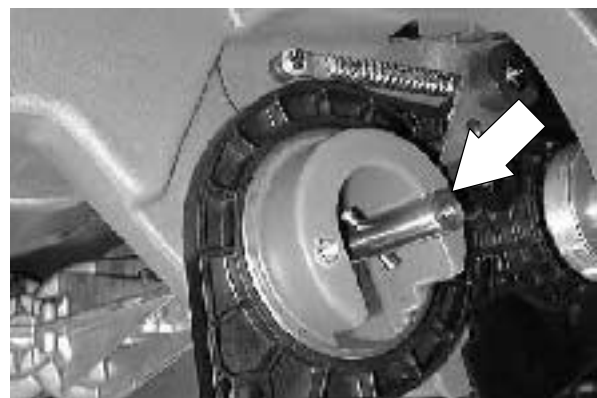

## SWEEPING

12. Reinstall both handle retainer plates.



13. Reinstall both drive wheels and hub caps.  
Tighten the flat screw to 7.6 - 9.9 Nm  
(6 - 8 ft lb).

*NOTE: Place machine in Neutral, then, rotate axle until cross pin is horizontal. Put machine in Park and install hub/wheel assembly.*



14. Install the main brush. See TO REPLACE MAIN BRUSH instructions.

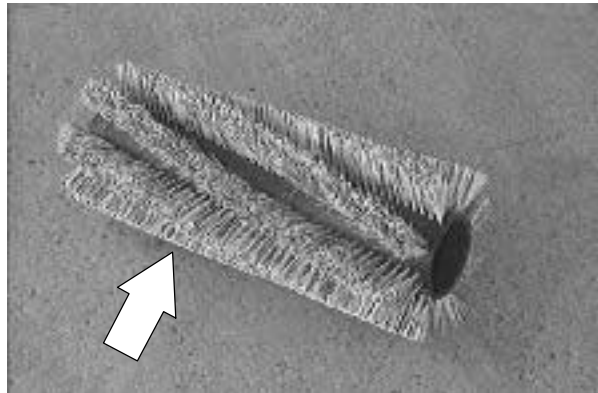

15. Lower the machine and operate the main brush. Check for proper operation.



**TO REMOVE MAIN BRUSH SHAFT**

**FOR SAFETY: Before Leaving Or Servicing Machine; Stop On Level Surface, Place Shifter In Park.**

1. Lower the main brush to the float position.

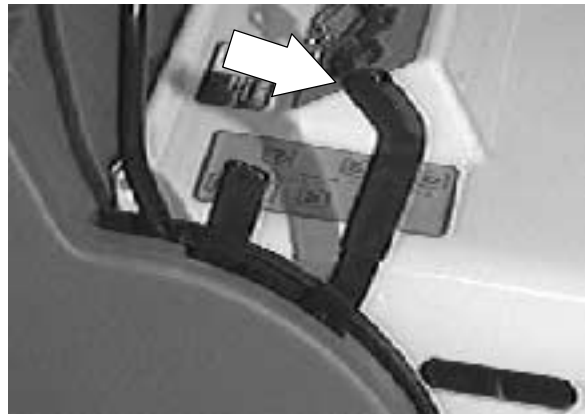

2. Go to the back of the machine and locate the brush shaft running between the left and right brush arms.

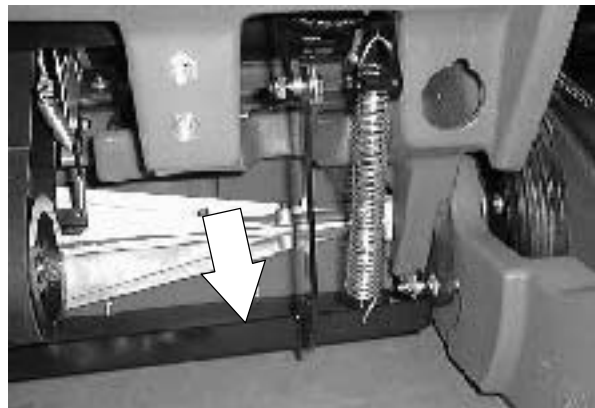

3. Remove the tension spring from the right side of the brush shaft.



## SWEEPING

4. Remove the two hex screws, sleeves, and nuts holding the brush shaft to the brush arms.

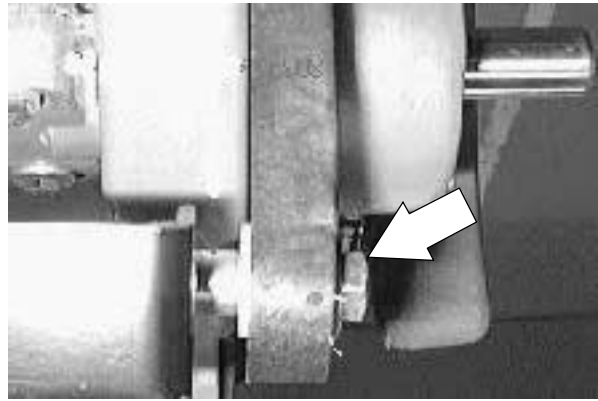

5. Remove the two hex screws, sleeves, and nuts holding the brush shaft to the upper pivot bar. Remove the brush shaft from the machine.

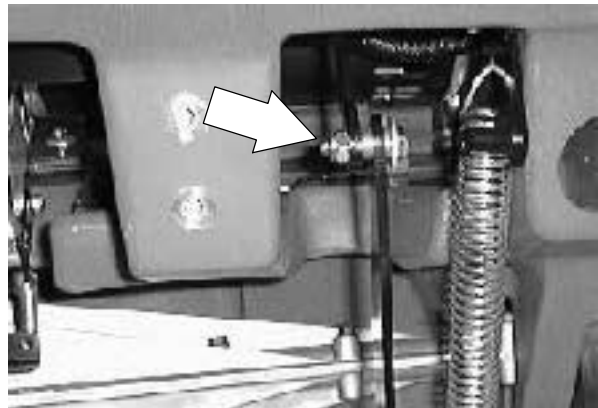

**TO INSTALL MAIN BRUSH SHAFT**

**FOR SAFETY: Before Leaving Or Servicing Machine; Stop On Level Surface, Place Shifter In Park.**

1. Position the new main brush shaft on the rear of the machine. Install the two hex screws, sleeves, and nuts. Tighten to 18 - 24Nm (15 - 20 ft lb).

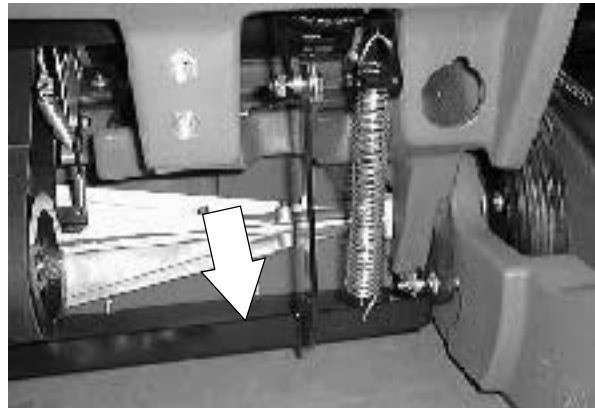

2. Line up the lower holes in the brush shaft with the holes in the rear of both brush arms. Install the two hex screws, sleeves, and nuts. Tighten to 18 - 24Nm (15 - 20 ft lb).

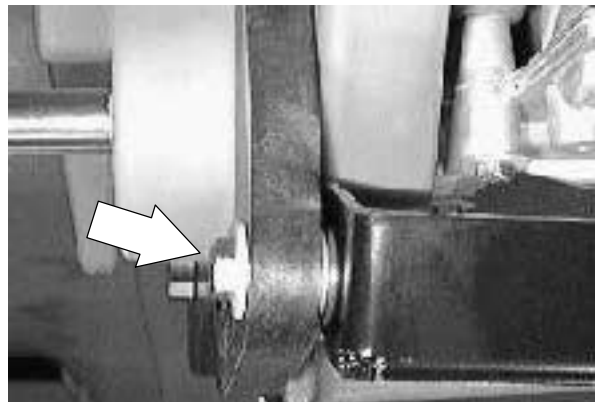

3. Reconnect the tension spring to the right side of the brush shaft and machine frame.

4. Start the machine and check the main brush pattern. See TO CHECK AND ADJUST MAIN BRUSH PATTERN instructions.

5. Raise and lower the main brush. Check the brush linkage for any binding or hanging up.



# SWEEPING

## SIDE BRUSH

The standard machine is equipped with a right hand side brush. A left hand side brush is optional. Both left and right side brushes are driven with an electric motor.

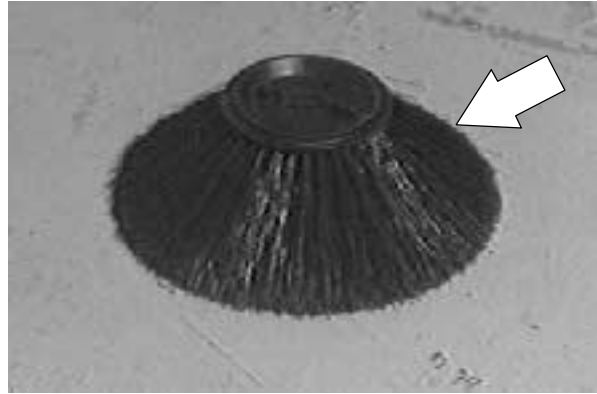

### TO REPLACE LH OR RH SIDE BRUSH

**FOR SAFETY: Before Leaving Or Servicing Machine; Stop On Level Surface, Place Shifter In Park.**

1. Make sure the side brush lever is in the raised position.



2. Go under the side brush and locate the hair pin clip on the bottom of the side brush motor shaft. Pull the pin out.

*NOTE: Some early models have two spacer washers under the hairpin.*

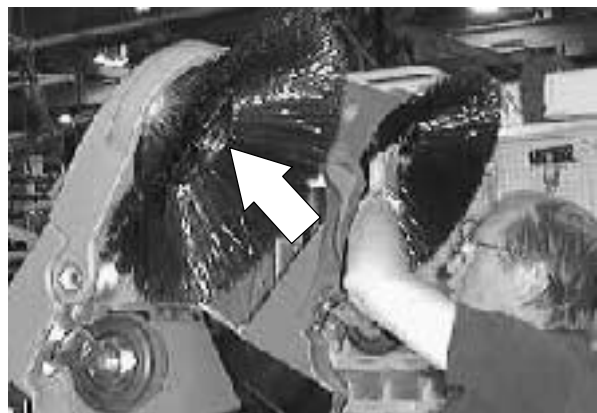

3. The side brush will drop off the side brush shaft. Remove the brush from the machine.

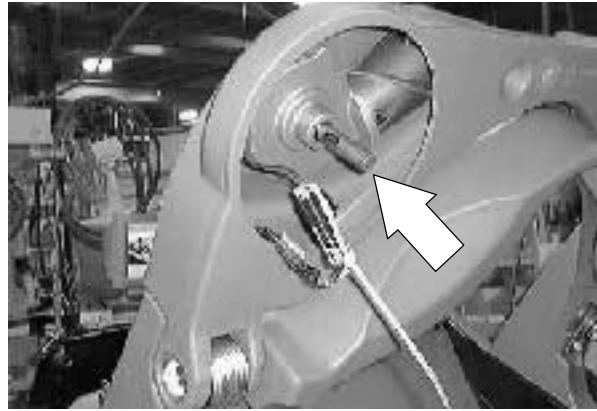

4. Position the new side brush under the front of the machine in the area of the side brush motor.

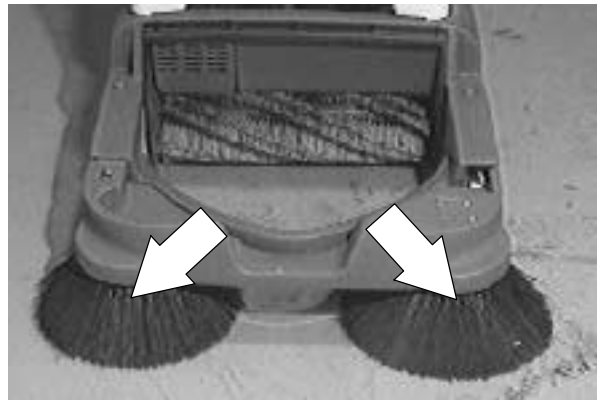

5. Lift the side brush up and onto the side brush motor shaft. Make sure the slots in the top of the side brush line up with the pin on the side brush motor shaft.
6. Reinstall the hair pin clip in the bottom of the side brush motor shaft.
7. Start the machine and check the side brush for proper operation.

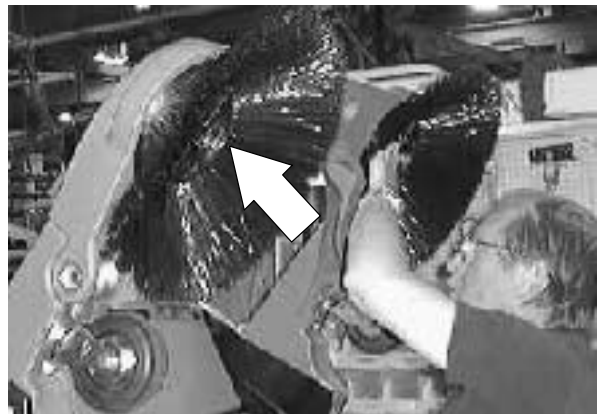

### TO REPLACE SIDE BRUSH LIFT CABLE

**FOR SAFETY: Before Leaving Or Servicing Machine; Stop On Level Surface, Place Shifter In Park.**

1. Remove the filter cover from the rear of the machine. Remove the handle stop bracket from the upper/left side of the filter compartment.

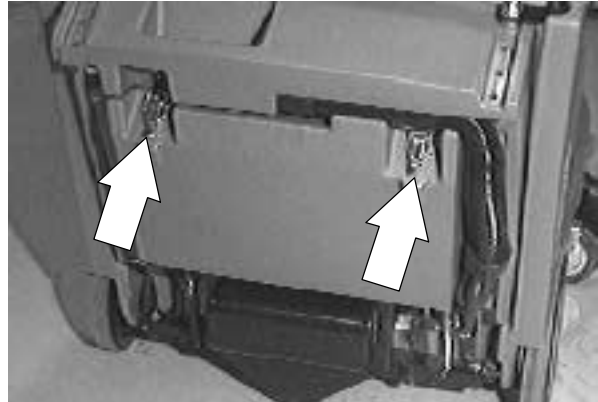

2. Pull up on the two handle locks and move the handle assembly to its lowest position.

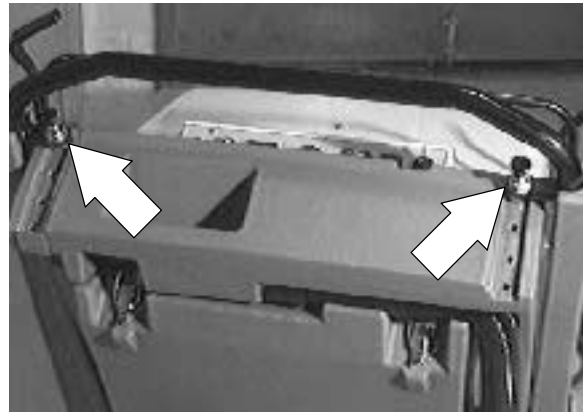

3. Remove the three hex screws holding the cover plate to the inside of the right side handle tower. Remove the cover plate from the machine.

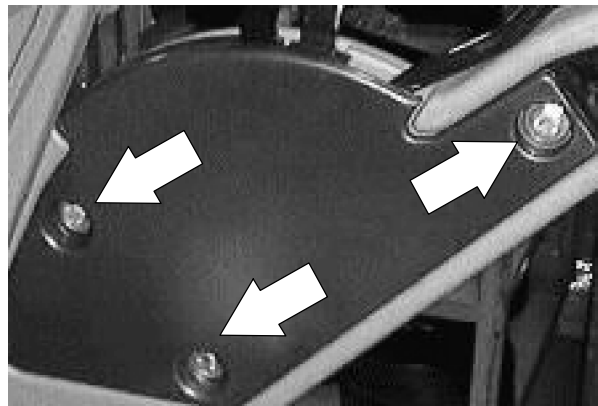

4. Remove the hardware holding the pivot plate to the plastic side arm. *This will allow the plate and handle assembly to be pulled away from the plastic arm for easy access.*

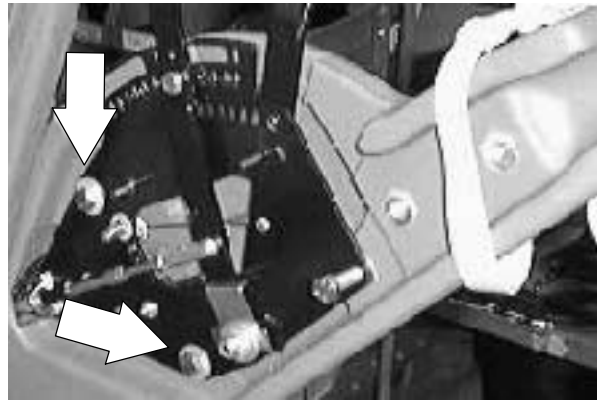

5. Remove the cotter pin and clevis pin from the end of the side brush lift cable where it attaches to the side brush lift lever.



6. Remove the nut from the clamp holding the side brush cable to the mount plate.



7. Remove the debris hopper from the machine.



## SWEEPING

8. Locate the side brush lift cable lower mount bracket on the right side of the frame, near the right front caster.
9. Remove the two hex screws holding the side brush lift cable lower mount bracket to the machine frame.



Pull the mount bracket out of the hole in the frame. Pull the side brush cable out of mount slot.

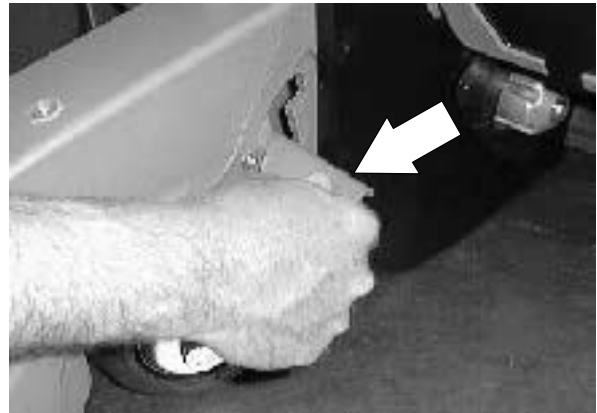

10. Remove the two hex screws holding the side brush lift cable spring assembly to the right side of the machine frame, out near the right side brush.



11. Pull the spring and cable assembly out of the machine frame.

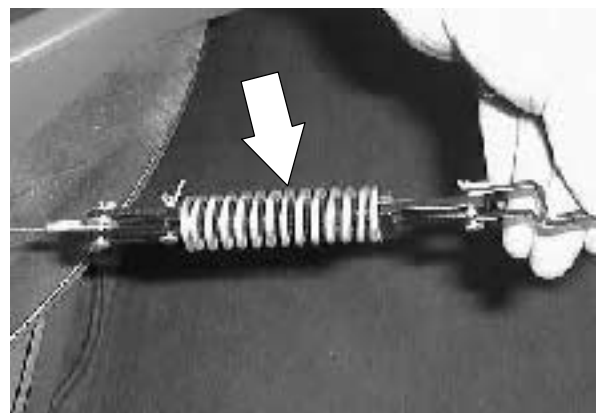



12. Remove the clevis pin holding the side brush lift cable to the spring assembly. Remove the side brush lift cable from the spring assembly.

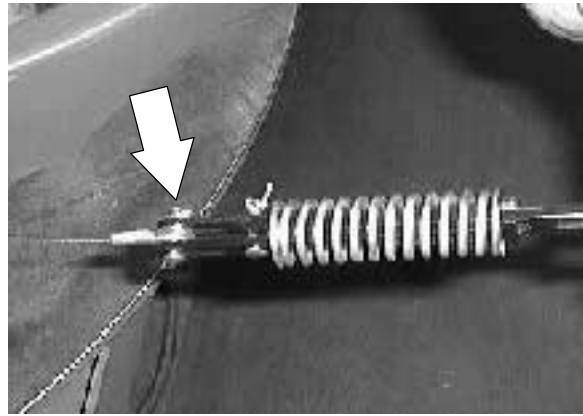

13. Route the new lift cable down the handle assembly, thru the hole in the handle, into the hole in the main frame, and down to the right side of the frame. Next, reach in the frame hole and grab the cable.



*NOTE: Add a cable tie around the new side brush cable and the existing stiff main brush lift cable. This will prevent the new side brush lift cable from drooping down and rubbing on the brush drive pulley.*

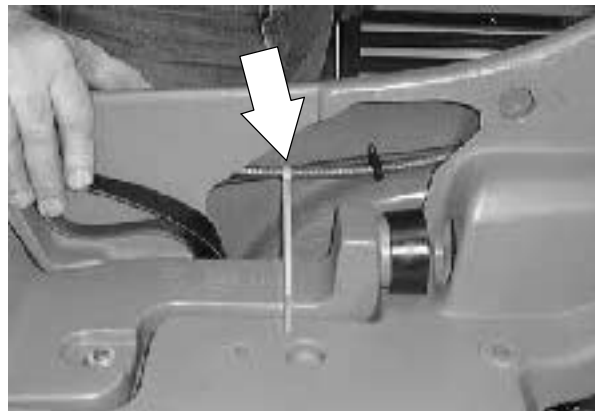

14. Reconnect the cable to the side brush spring assembly. Reinstall the spring assembly on the frame. Tighten the two hex screws to 7.6 - 9.9 Nm (6 - 8 ft lb).



## SWEEPING

15. Position the side brush lift cable in the slot on the lower mount bracket. Reinstall the lower mount bracket in the machine. Tighten the two hex screws to 8 - 24Nm (15 - 20 ft lb).



16. Go up to the main brush lift lever and install the nut on the main brush lift cable mount clamp. Tighten the nut to 7.6 - 9.9 Nm (6 - 8 ft lb).

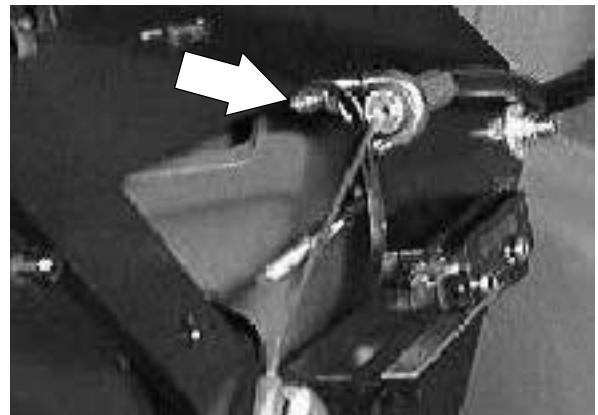

17. Install the clevis pin and cotter pin in the end of the new cable where it attaches to the side brush lift lever.



18. Position the brush lift lever assembly back onto the right handle arm.

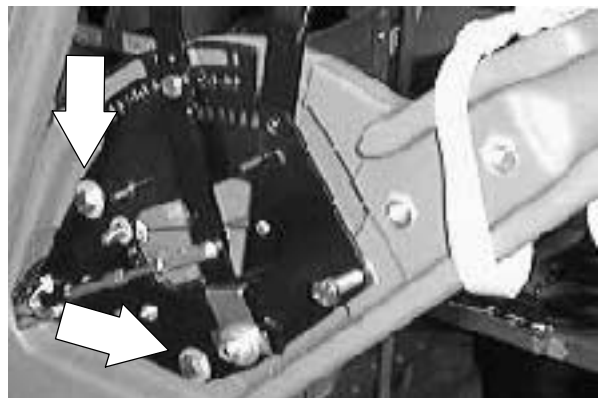

19. Reinstall the right side handle assembly cover plate. Tighten the three hex screws to 18 - 24 Nm (15 - 20 ft lb).

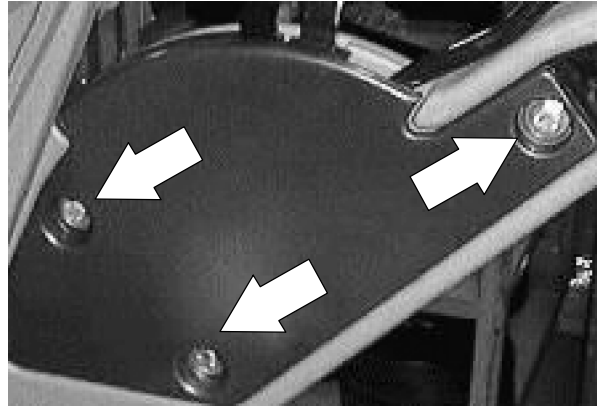

20. Move the handle assembly up to one of the four adjustment holes.

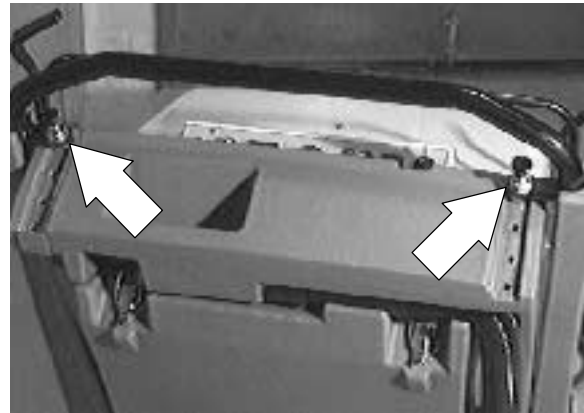

21. Reinstall the filter cover and the handle stop bracket.

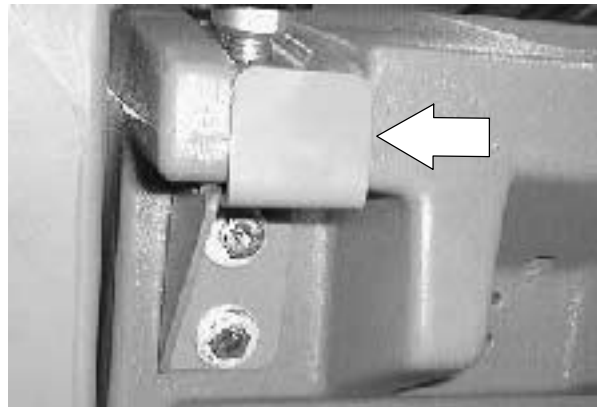

22. Start the machine and check the side brush lift cable for proper operation.

23. Close the engine cover.



## SWEEPING

### TO REPLACE SIDE BRUSH HOUSING

**FOR SAFETY: Before Leaving Or Servicing Machine; Stop On Level Surface, Place Shifter In Park.**

1. Remove the hopper from the machine. See TO REMOVE DEBRIS HOPPER instructions.



2. Lower the side brush(s).

3. Remove the side brush(es). See TO REPLACE LH OR RH SIDE BRUSH instructions in the SWEEPING section.



4. Un-plug the side brush motor(s) from the main electrical harness.

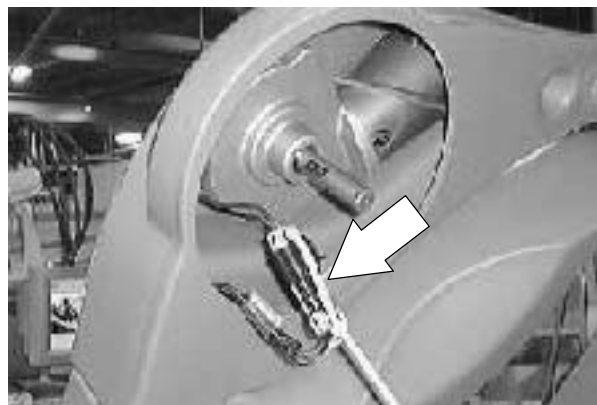

5. Remove the four hex screws holding the side brush motor(s) and gear box(s) to the side brush housing.

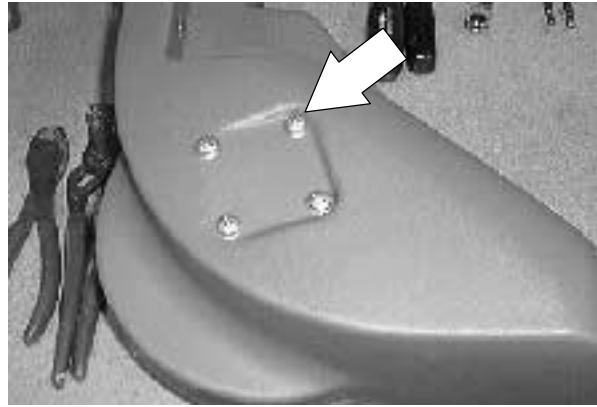

6. Remove the side brush motor(s) and gear box(s) from the machine.

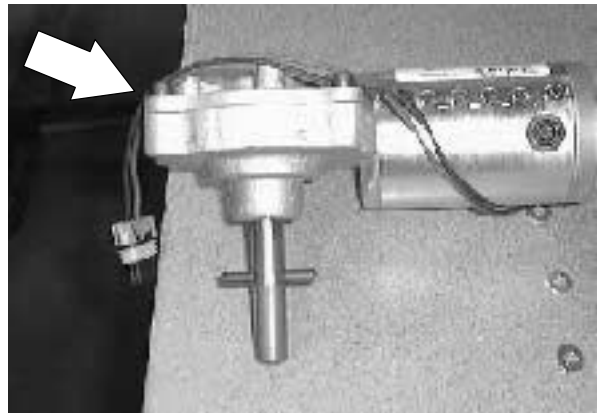

7. Remove the two screws holding the side brush lift cable assembly to the side brush housing.



8. Remove the hex screw and sleeve from the left side of the side brush housing.

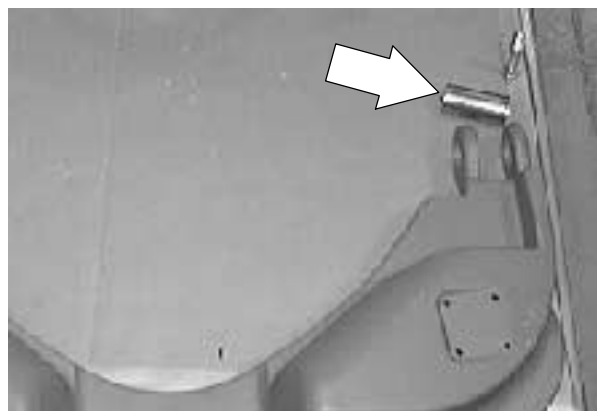

## SWEEPING

9. SLOWLY remove the hex screw from the right side of the side brush housing.

*NOTE: There is a large spring that is under tension in the right side of the side brush housing. This spring will partially un-wind when the right hex screw and sleeve are removed. If your machine is equipped with dual side brushes--there is a tension spring on both sides.*



10. Position the new side brush housing in front of the machine. If your machine has a RH side brush only--place the sleeve in the hole in the left arm of the housing. Bring that end up and line up the hole in the sleeve with the threaded insert in the main frame. Install the hex screw--but leave loose for now.

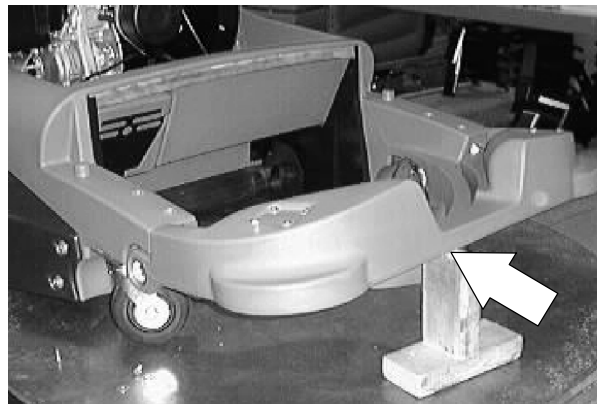

11. Go the right side arm of the housing and position the tension spring in the opening where the sleeve is inserted. Once the spring is positioned correctly--place the sleeve through the arm holes and the center of the tension spring. Bring that end up carefully, making sure the spring is pulled back and one end placed down the main machine frame. Line up the hole in the sleeve with the threaded insert in the main frame. Install the hex screw, Tighten both screws to 28 - 36 Nm (20 - 26 ft lb).

*NOTE: Repeat this procedure on the left side if your machine is equipped with dual side brushes.*

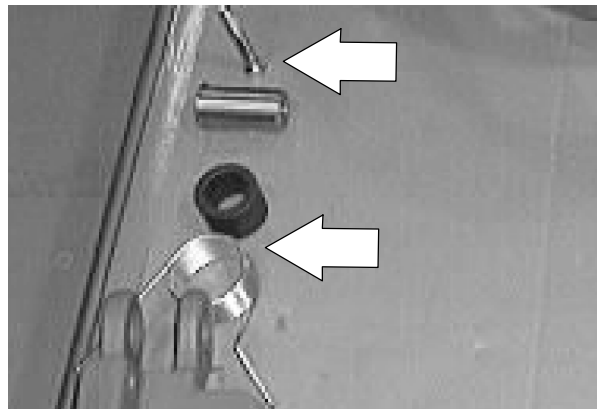

12. Reinstall the side brush lift cable bracket on the side brush housing. Tighten the two screws to 7.6 - 9.9 Nm (6 - 8 ft lb).

*NOTE: Push the housing down to install the hardware. Lift up on the front of the housing and push the side brush bracket toward the rear of the machine. Tighten the hardware.*

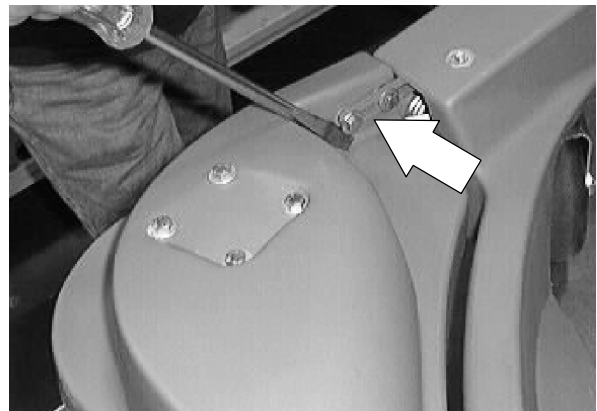

13. Position the side brush motor(s) and gear box(s) in the machine. Line up the mount holes in the side brush housing with the mount holes in the side brush motor.

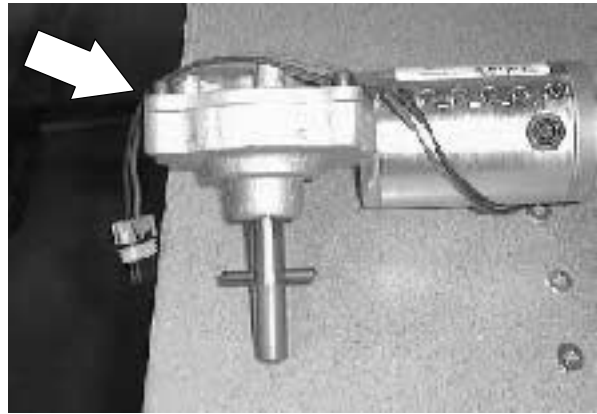

14. Reinstall the hex screws and tighten to 7.6 - 9.9 Nm (6 - 8 ft lb).



15. Reconnect the side brush motor(s) to the main harness. See schematic in the ELECTRICAL section.

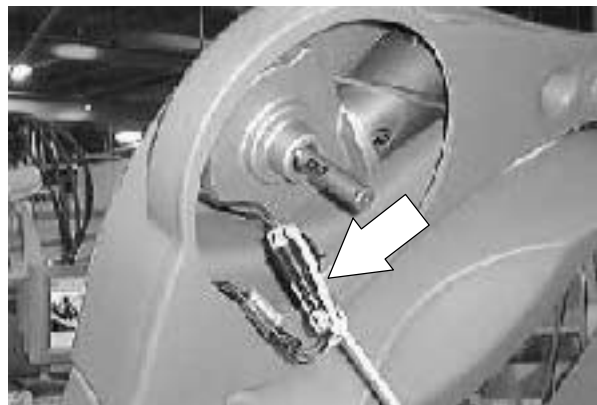

16. Reinstall the side brush(es). See TO REPLACE LH OR RH SIDE BRUSH instructions in the SWEEPING section.

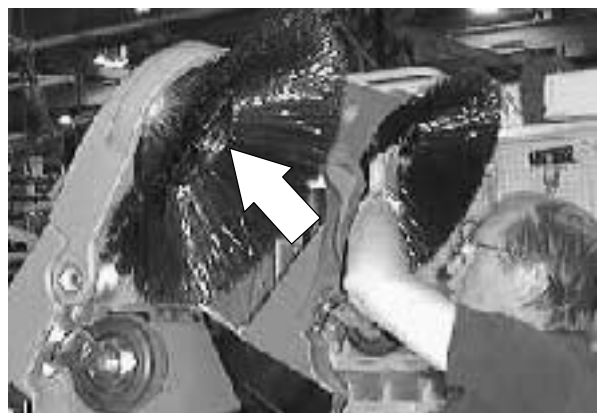

17. Operate the machine and check the side brush for proper operation.

## SKIRTS AND SEALS

The skirts and seals on the model 3640 are used to contain dust and debris during the sweeping operation. The skirts and seals must be free of tears or damage to achieve the best sweeping performance. Inspect and replace any damaged skirt or seal.

### HOPPER LIP SKIRT

The hopper lip skirt deflects debris from the main brush and into the hopper. It allows debris to pass under the hopper and into the rotating main brush. Inspect the hopper lip skirt every time the hopper is dumped.

### TO REPLACE HOPPER LIP SKIRT

**FOR SAFETY: Before Leaving Or Servicing Machine; Stop On Level Surface, Place Shifter In Park.**

1. Remove the hopper from the machine. See TO REMOVE DEBRIS HOPPER instructions.
2. Dump any debris from the hopper.
3. Remove the hex screws holding the skirt and retainer to the hopper lip.

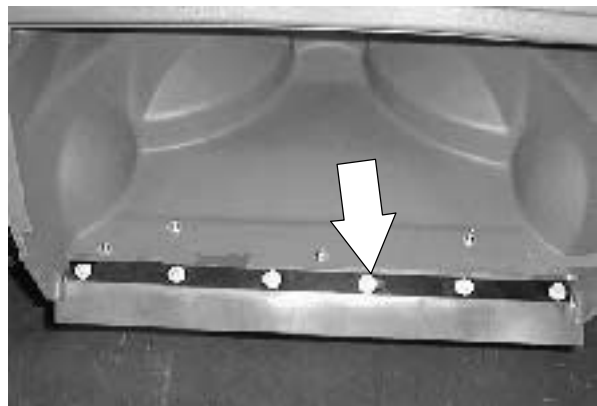
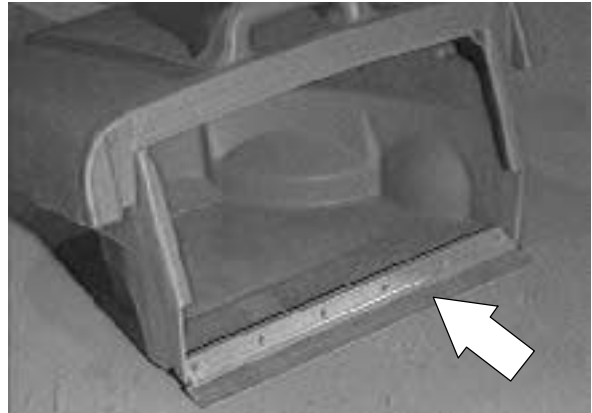



4. Remove the skirt and retainer from the machine. Discard the skirt.

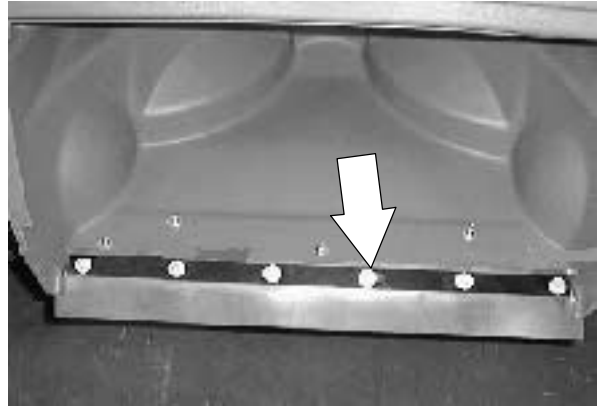

5. Position the new skirt and existing retainer on the hopper. Reinstall the hardware and tighten to 7.6 - 9.9 Nm (6 - 8 ft lb).

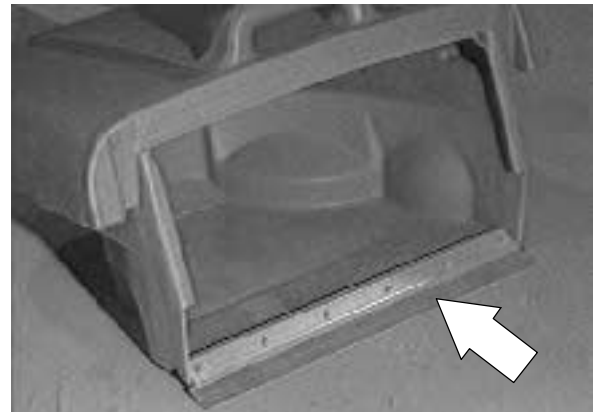

6. Reinstall the debris hopper. See TO INSTALL DEBRIS HOPPER instructions.



## SWEEPING

### REAR SKIRT

The rear skirt and recirculation flap are used to contain any debris and help create a vacuum chamber around the main brush. The rear skirt should be adjusted slightly off the ground to allow air flow and avoid any dusting problems.

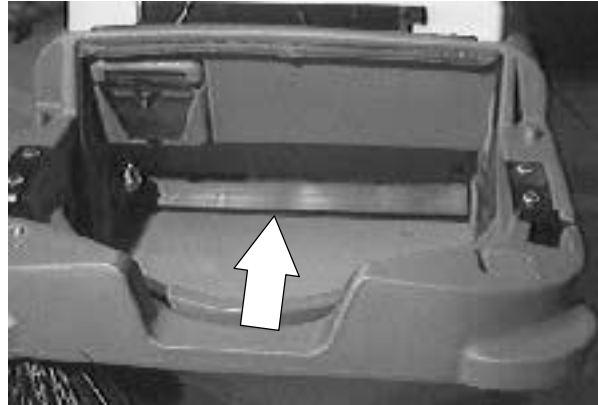

### TO REPLACE REAR SKIRT/RECIRCULATION FLAP

**FOR SAFETY: Before Leaving Or Servicing Machine; Stop On Level Surface, Place Shifter In Park.**

1. Remove the hopper from the machine. See TO REMOVE DEBRIS HOPPER instructions.



2. Remove the main brush. See TO REPLACE MAIN BRUSH instructions.



3. Remove the five nuts from the back of the brush wrap. Remove and retain the five bolt plates.

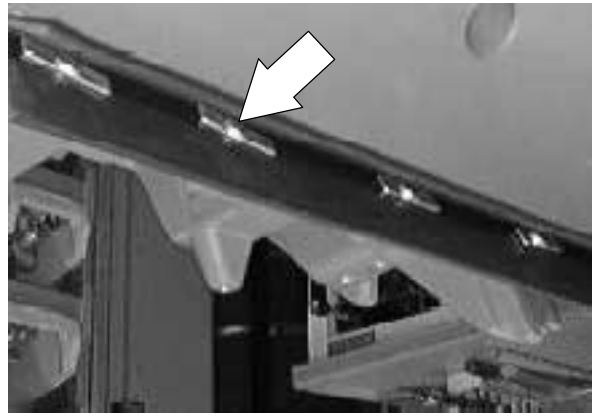

4. Remove the rear skirt/recirculation flap from the machine.

5. Install the new rear skirt/recirculation flap on the machine. Lift the rear skirt/recirculation flap and install the five bolt plates through the rear skirt/recirculation flap and the machine frame. Install the five nuts and lightly tighten.

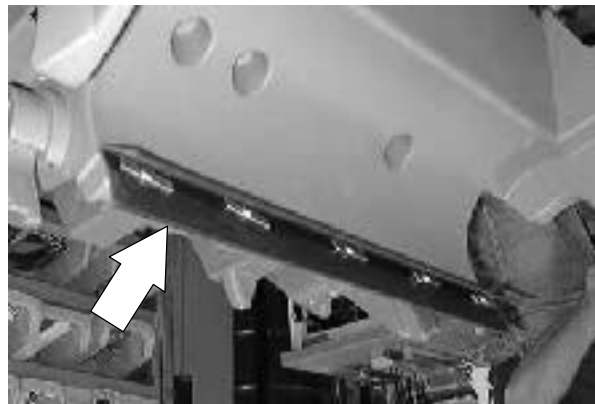

6. Reinstall the main brush. See TO REPLACE MAIN BRUSH instructions.

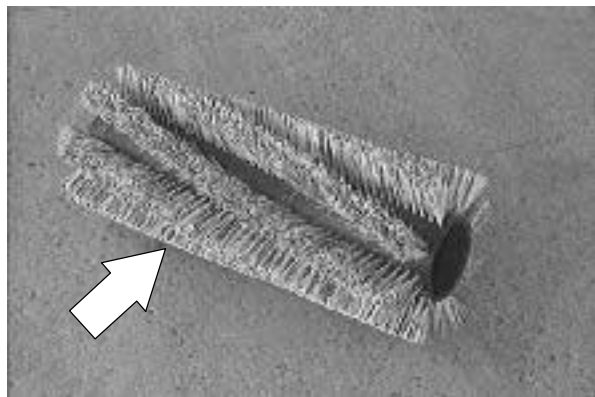

7. Reinstall the hopper in the machine. See TO INSTALL DEBRIS HOPPER instructions.

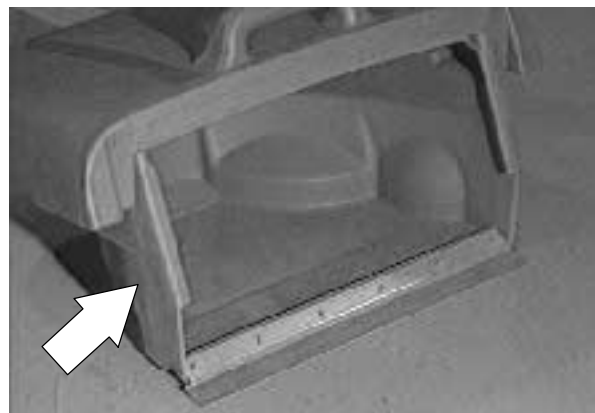

8. Operate the machine and check for proper sweeping operation.

## SWEEPING

### UPPER HOPPER SEAL

The upper hopper seal is used to seal the back of the hopper to the machine frame. This seal prevents dust and debris from being expelled outside the brush compartment area.



### TO REPLACE UPPER HOPPER SEAL

**FOR SAFETY: Before Leaving Or Servicing Machine; Stop On Level Surface, Place Shifter In Park.**

1. Remove the hopper from the machine. See TO REMOVE DEBRIS HOPPER instructions.



2. Lift the upper hopper seal up slightly and locate the plastic rivets holding the seal to the machine.

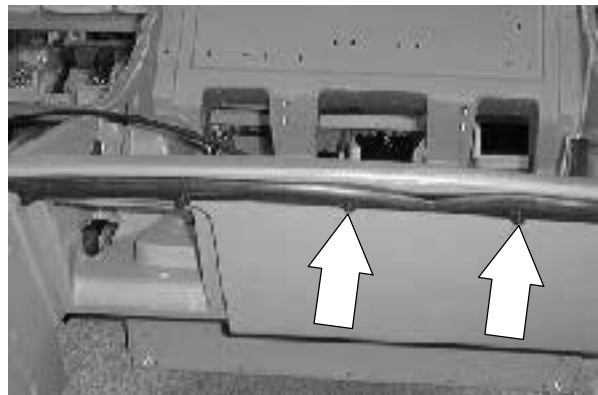

3. Un-screw the center pin out of the plastic rivets. Lift the body of the rivet out of the hole. Repeat on the rest of the rivets.
4. Remove the old upper hopper seal from the machine.



5. Position the new upper hopper seal on the machine. Line up the holes in the seal with the mount holes in the machine frame.
6. Install the plastic rivets in the mount holes. Start by placing the body of the rivet in the hole first, then screw the center pin into the body until it snaps in place.



7. Reinstall the hopper in the machine. See TO INSTALL DEBRIS HOPPER instructions.

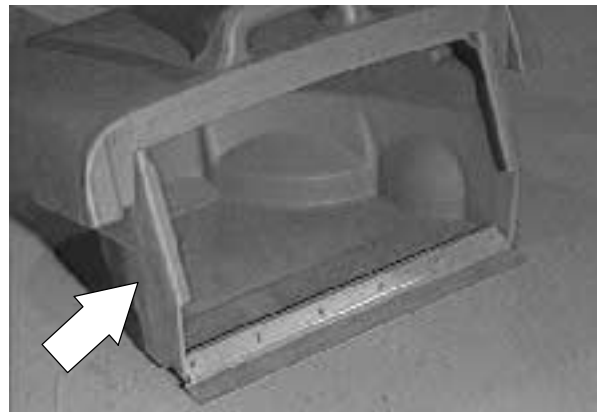

## SWEEPING

### MAIN BRUSH DUST SEALS

The main brush dust seals are used to seal the main brush to the sides of the brush compartment.



### TO REPLACE LEFT BRUSH SEAL (idler side)

**FOR SAFETY: Before Leaving Or Servicing Machine; Stop On Level Surface, Place Shifter In Park.**

1. Remove the hopper from the machine. See TO REMOVE DEBRIS HOPPER instructions.



2. Remove the main brush. See TO REPLACE MAIN BRUSH instructions.



3. Remove the seven plastic rivets holding the left dust seal to the inside of the brush compartment.

*NOTE: Use a pliers or side cutter to remove the center pin out of the plastic rivet. Lift the body of the rivet out of the hole. Repeat on all of the rivets.*

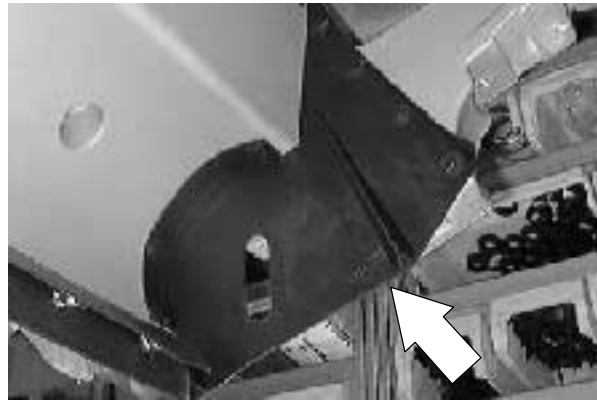

4. Remove the old seal from the machine.

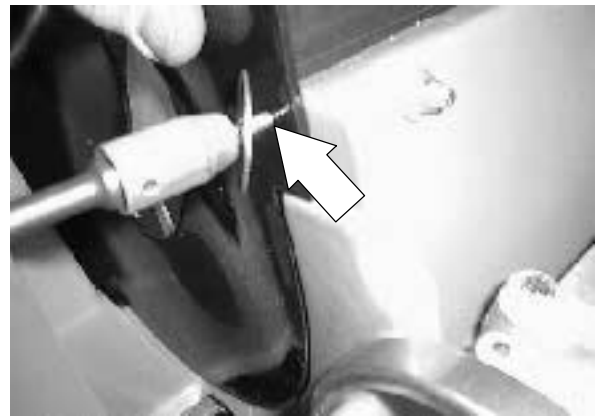

5. Install the new left dust seal on the machine. Line up the holes in the new seal with the mount holes in the machine frame.



6. Install the seven plastic rivets in the mount holes. Start by placing the body of the rivet in the hole first, then push the center pin into the body until it snaps in place.

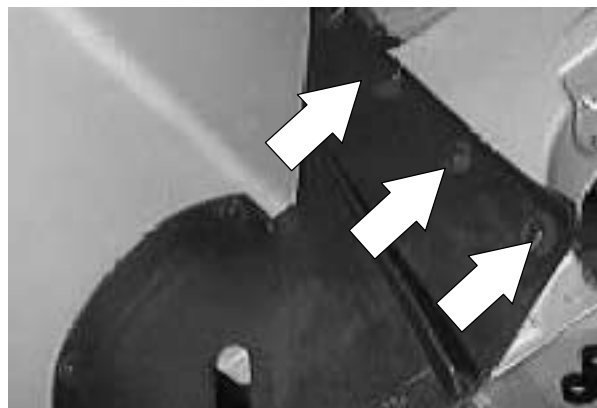

## SWEEPING

7. Reinstall the main brush. See TO REPLACE MAIN BRUSH instructions.

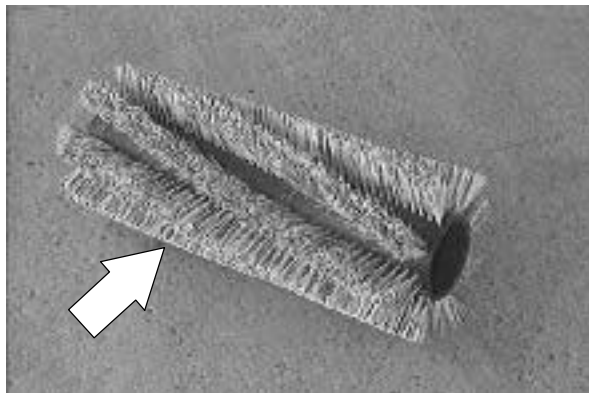

8. Reinstall the hopper in the machine. See TO INSTALL DEBRIS HOPPER instructions.

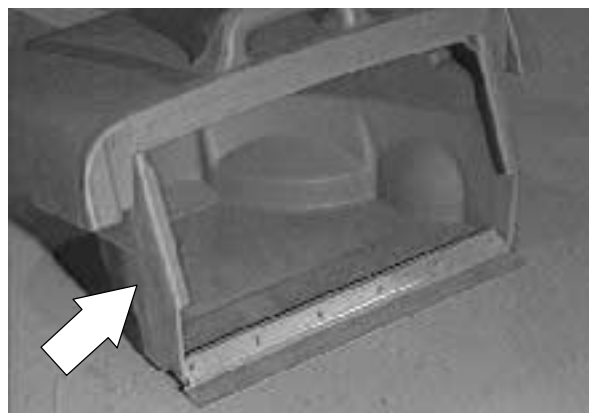



**TO REPLACE RIGHT BRUSH SEAL  
(drive belt side)**

**FOR SAFETY: Before Leaving Or  
Servicing Machine; Stop On Level  
Surface, Place Shifter In Park.**

1. Remove the hopper from the machine. See TO REMOVE DEBRIS HOPPER instructions.



2. Remove the main brush. See TO REPLACE MAIN BRUSH instructions.



3. Remove the hex screw holding the main brush drive plug to the shaft. Pull the drive plug off the shaft.

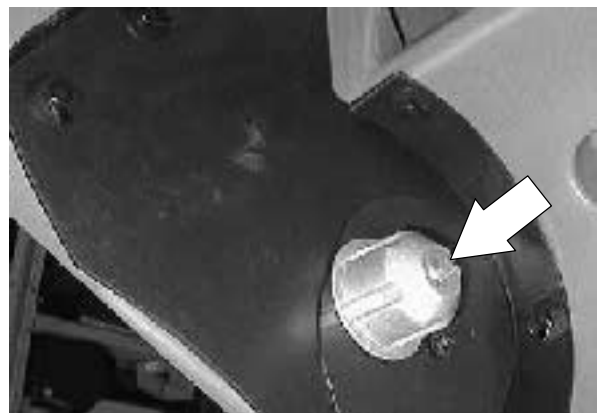

## SWEEPING

4. Remove the seven plastic rivets holding the right dust seal to the inside of the brush compartment.

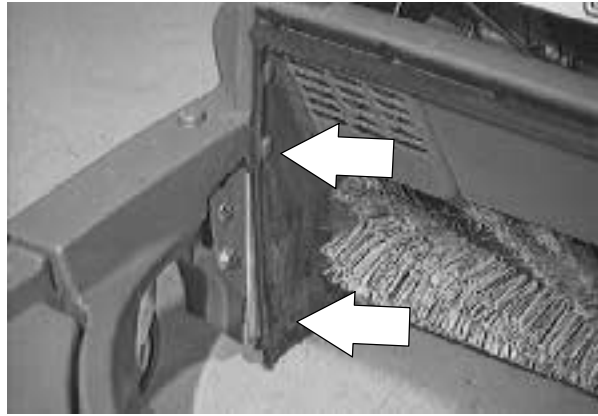

5. Use a pliers or side cutter to remove the center pin out of the plastic rivet. Lift the body of the rivet out of the hole. *Repeat this on all rivets.*

6. Remove the old seal from the machine.

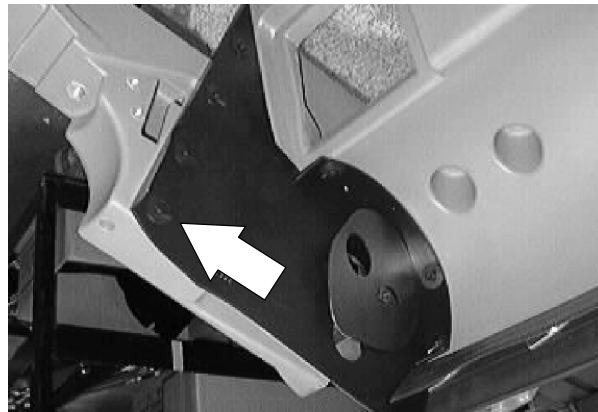

7. Remove the small cap retainer holding the inside plate to the right seal. Remove the inside plate and install it on the new right seal in the same orientation. Reinstall the small cap retainer.



8. Install the new right dust seal and plate assembly on the machine. Line up the holes in the new seal with the mount holes in the machine frame.



9. Install the seven plastic rivets in the mount holes. Start by placing the body of the rivet in the hole first, then push the center pin into the body until it snaps in place.

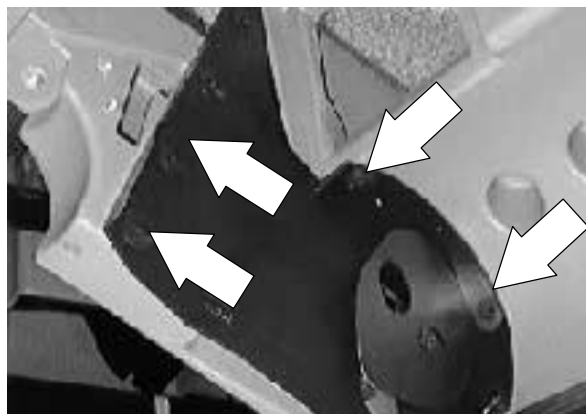

10. Reinstall the main brush drive plug on the shaft. Make sure the key is in place on the shaft. Reinstall the hex screw and tighten to 7.6 - 9.9 Nm (6 - 8 ft lb).

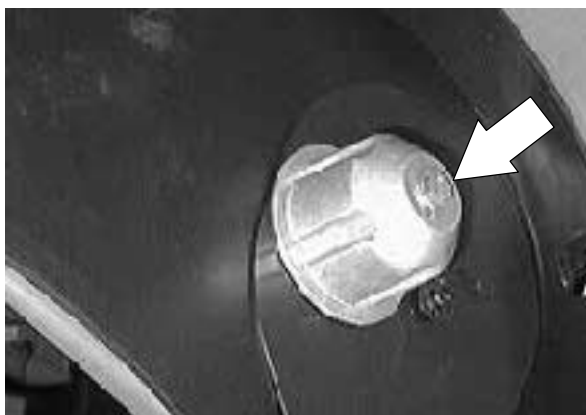

11. Reinstall the main brush. See TO REPLACE MAIN BRUSH instructions.

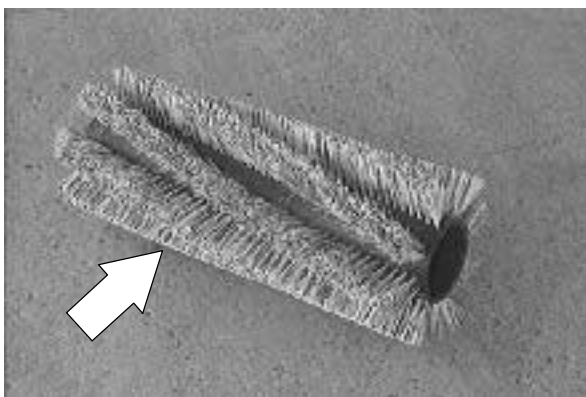

12. Reinstall the hopper in the machine. See TO INSTALL DEBRIS HOPPER instructions.

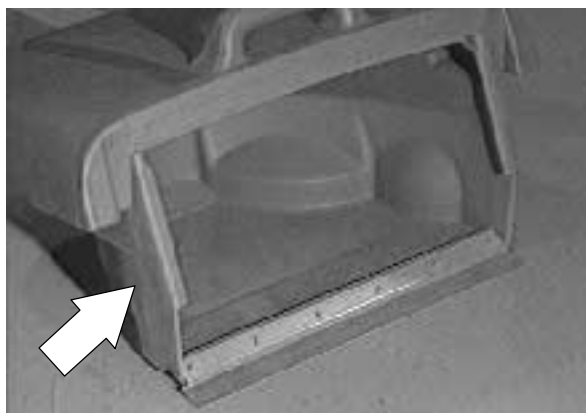

## VACUUM FAN

The vacuum fan pulls air from the main brush compartment and through the filter assembly. The filter bag (standard) is removed and discarded after it becomes full. The panel filter (optional) can be cleaned with the filter shaker or can be removed and cleaned outside of the machine.

### TO REMOVE VACUUM FAN ASSEMBLY

**FOR SAFETY: Before Leaving Or Servicing Machine; Stop On Level Surface, Place Shifter In Park.**

1. Open the engine cover.

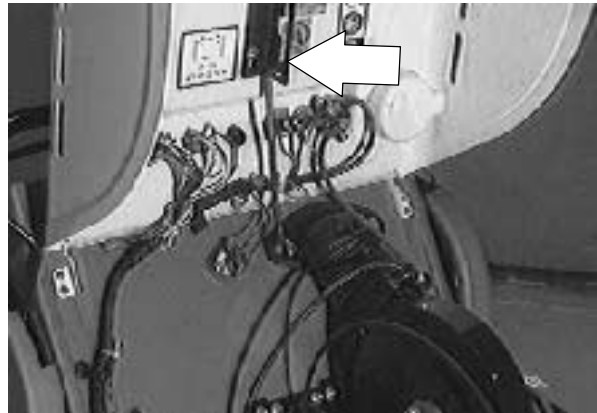

2. Remove the air duct running from the top of the vacuum fan to the front wall of the dust filter.



3. Remove the clamp holding the cable to the top of the vacuum fan housing.

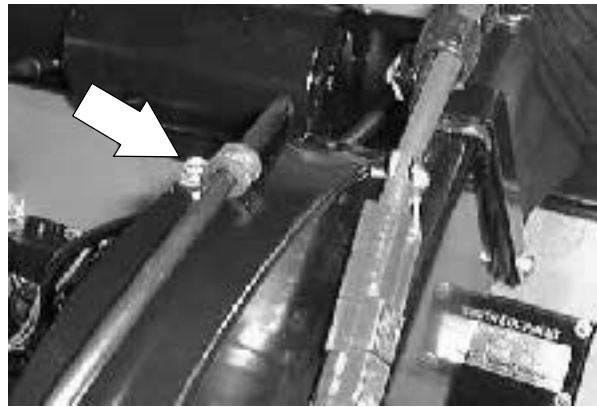

4. Locate the tension bolt and slotted bracket on the side of vacuum fan opposite the V-belt pulley. Remove the tension bolt.

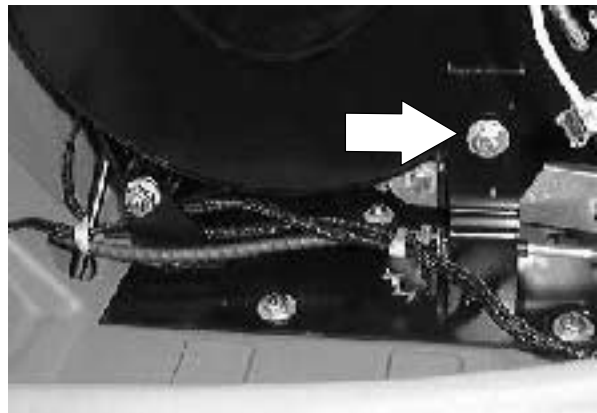

5. Let the vacuum fan drop down. Remove the V-belt from the pulley on the fan.

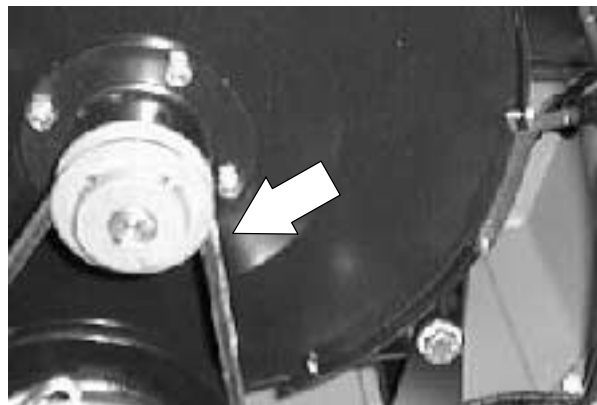

6. Remove the hex screw and nut holding the vacuum fan assembly to the pivot mount bracket. Remove the vacuum fan from the machine.

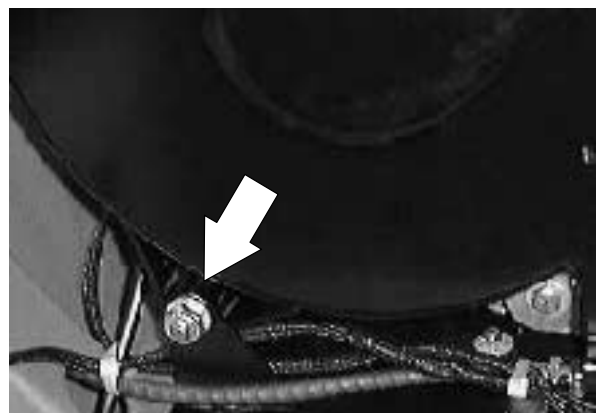

## SWEEPING

### TO INSTALL VACUUM FAN ASSEMBLY

**FOR SAFETY: Before Leaving Or Servicing Machine; Stop On Level Surface, Place Shifter In Park.**

1. Open the engine cover.

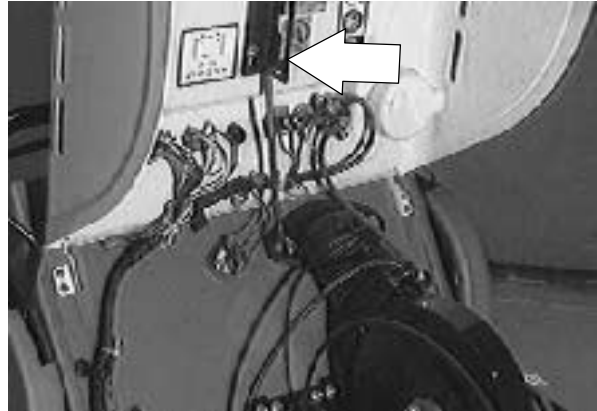

2. Position the vacuum fan assembly in the machine. Line up the mount hole in the pivot bracket with the pivot mount on the fan housing. Install the hex screw and nut. Tighten so the vacuum fan can pivot freely for belt tensioning.

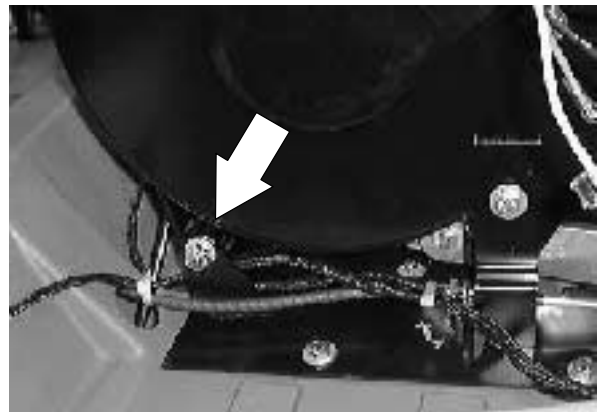

3. Install the bolt in the tension slot and vacuum fan housing. Leave loose for now.

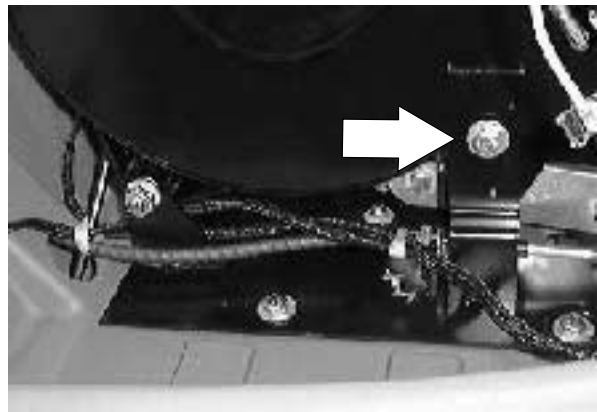

4. Install the V-belt on the vacuum fan drive pulley.

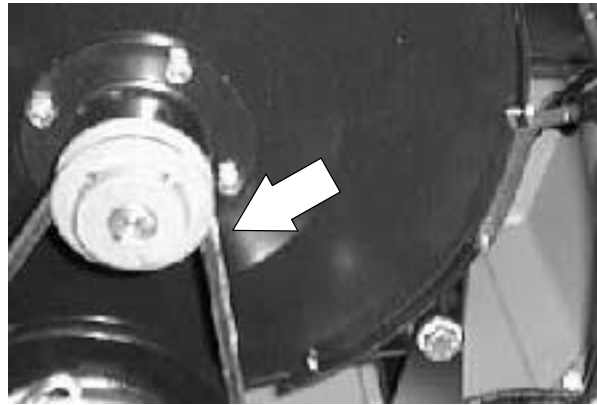

5. Pull up on the vacuum fan assembly until the V-belt is tight. Tighten the tension bolt to 18 - 24 Nm (15 - 20 ft lb). See TO TENSION VACUUM FAN V-BELT

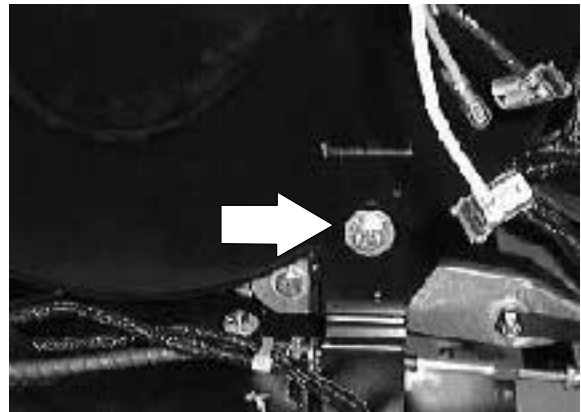

6. Reinstall the clamp and cable on the top of the vacuum fan housing.



7. Reinstall the air duct running from the top of the vacuum fan to the front wall of the dust filter.



## SWEEPING

8. Close the engine cover.

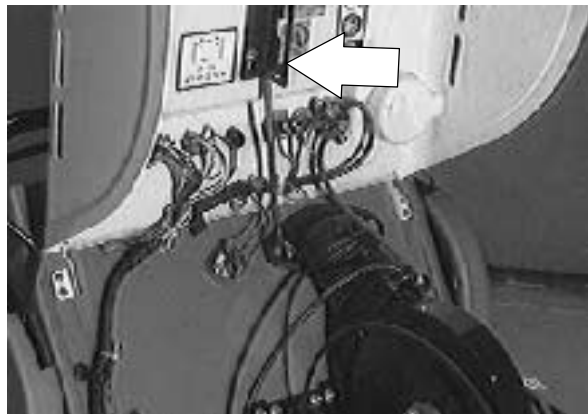

9. Start the machine and check the vacuum fan for proper operation.



**TO REPLACE VACUUM FAN IMPELLER**

**FOR SAFETY: Before Leaving Or Servicing Machine; Stop On Level Surface, Place Shifter In Park.**

1. Remove the vacuum fan assembly from the machine. See TO REMOVE VACUUM FAN ASSEMBLY instructions.

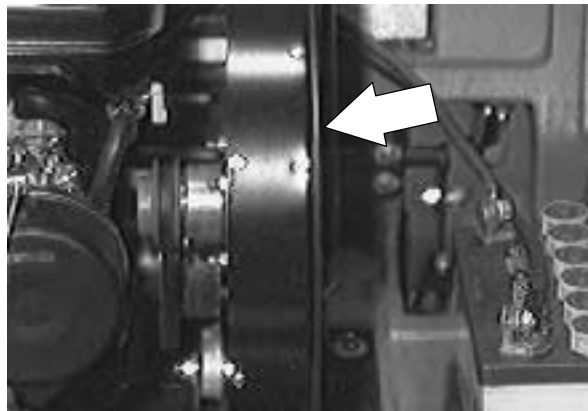

2. Remove the smaller hex screws holding the vacuum fan housing to the bearing backing plate. Pull the housing off the backing plate.

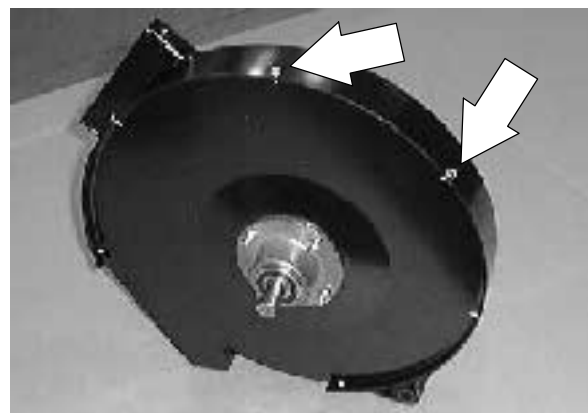

3. Hold the impeller from turning. Remove the hex nut from the impeller shaft.

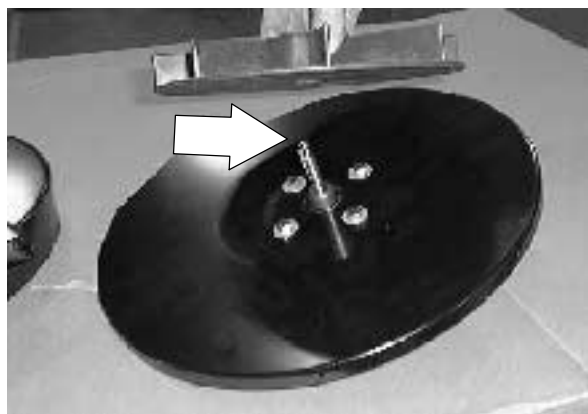

## SWEEPING

4. Pull the impeller straight up and off the shaft. You may have to use a small pry bar or flat screw driver to pry the impeller off. Do not loose the key on the impeller shaft.
5. Position the new impeller on the impeller shaft. Make sure the key is in place on the shaft.
6. Hold the impeller from turning. Install the hex nut on the impeller shaft. Tighten to 18 - 24Nm (15 - 20 ft lb).

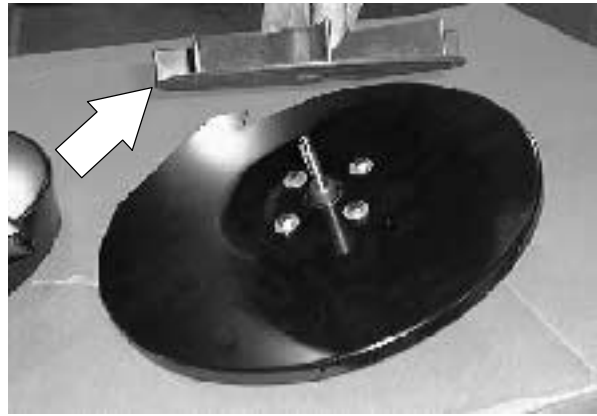

7. Reinstall the vacuum fan housing on the bearing backing plate. Hand tighten the smaller hex screws.

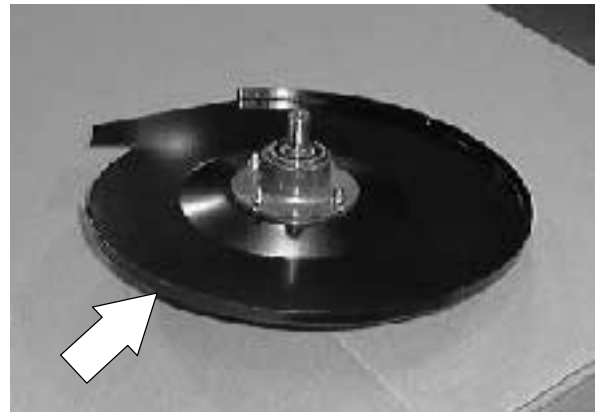

8. Reinstall the vacuum fan assembly in the machine. See TO INSTALL VACUUM FAN ASSEMBLY instructions.

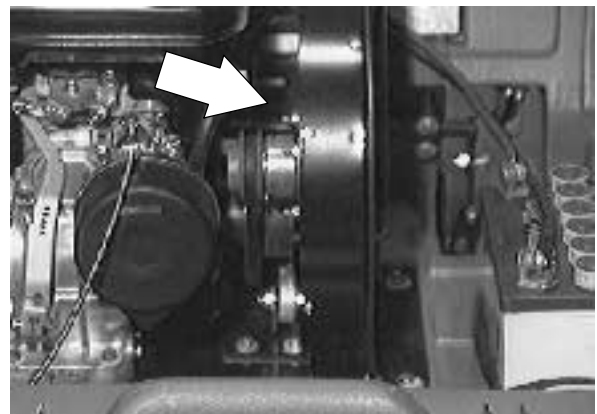

9. Start the machine and check the vacuum fan for proper operation.

**TO REPLACE VACUUM FAN IMPELLER BEARINGS**

**FOR SAFETY: Before Leaving Or Servicing Machine; Stop On Level Surface, Place Shifter In Park.**

1. Remove the vacuum fan assembly from the machine. See TO REMOVE VACUUM FAN ASSEMBLY instructions.

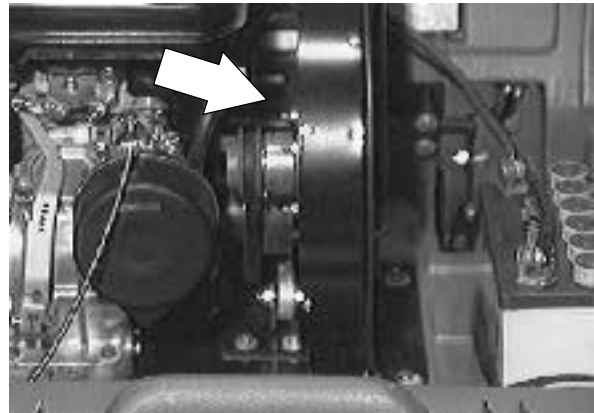

2. Remove the smaller hex screws holding the vacuum fan housing to the bearing backing plate. Pull the housing off the backing plate.

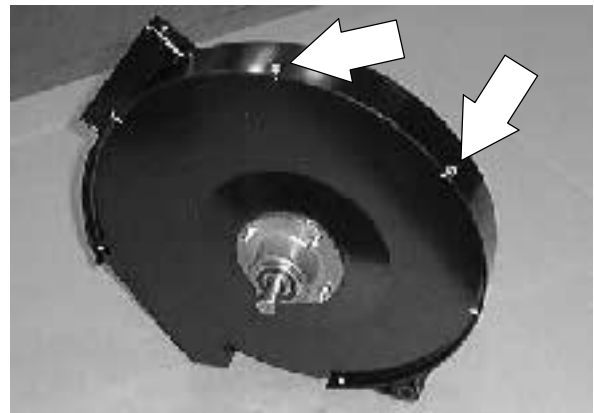

3. Hold the impeller from turning. Remove the hex nut from the impeller shaft.

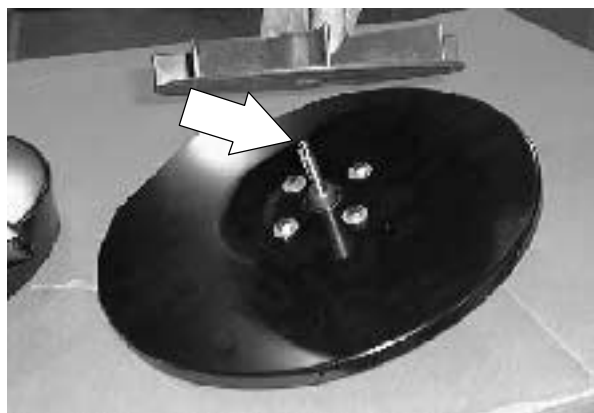

## SWEEPING

4. Pull the impeller straight up and off the shaft. You may have to use a small pry bar or flat screw driver to pry the impeller off. Do not loose the key on the impeller shaft.

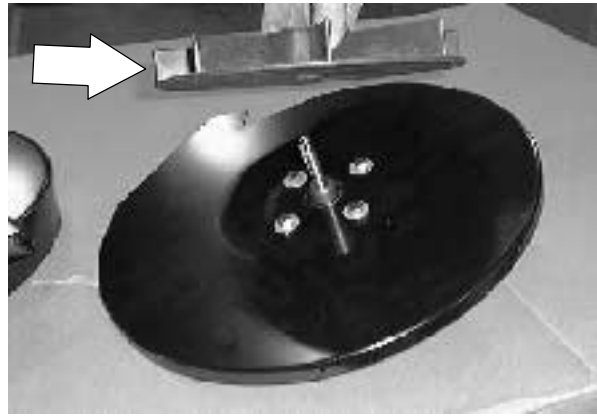

5. Remove the four hex screws and nuts holding the bearing and pulley assembly to the backing plate. Remove the bearing assembly.

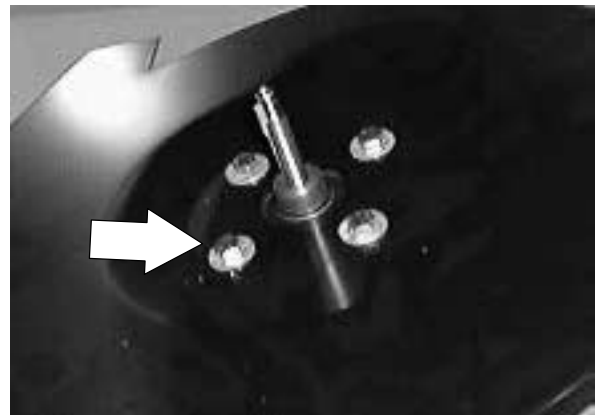

6. Loosen the set screws on the impeller belt pulley. Slide the pulley off the impeller shaft.

*NOTE: Make sure to mark the location of the pulley on the impeller shaft for proper re-assembly.*



7. Use a press to remove the impeller shaft and inner bearing from the bearing housing. Press the bearing and shaft in the direction of the fan shaft.

8. Press the second bearing out of the housing.



9. Press a new bearing in the housing on the pulley side. Press the bearing in until the snap ring contacts the housing.

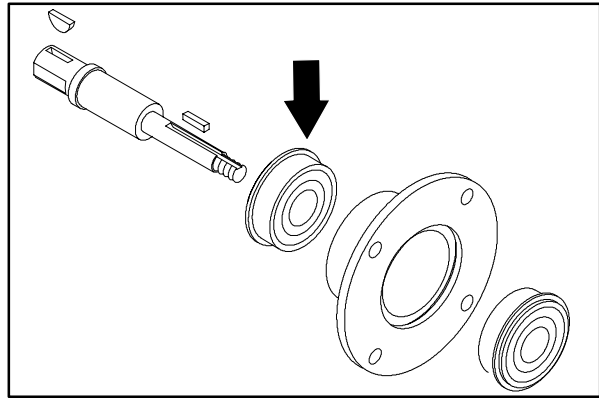

10. Press the impeller shaft into the new bearing. *Note: the impeller side of the shaft must be on the flange side of the bearing housing.*

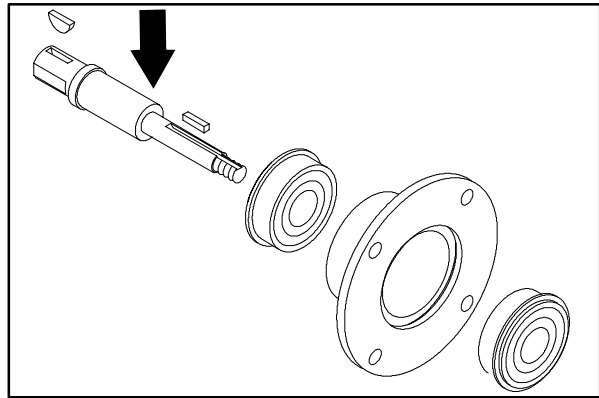

11. Press the second bearing into the housing over the impeller shaft. Press the bearing in until the snap ring contacts the housing.

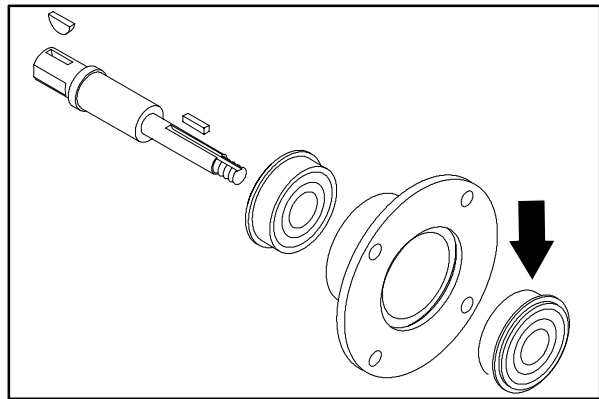

12. Reinstall the bearing assembly on the backing plate. Reinstall the hardware and tighten to 7.6 - 9.9 Nm (6 - 8 ft lb).



## SWEEPING

13. Reinstall the pulley on the larger diameter end of the impeller shaft. Make sure the pulley is positioned in the same location as it was removed. Hand tighten the set screws tight.



14. Reinstall the impeller on the impeller shaft. Make sure the key is in place on the shaft.

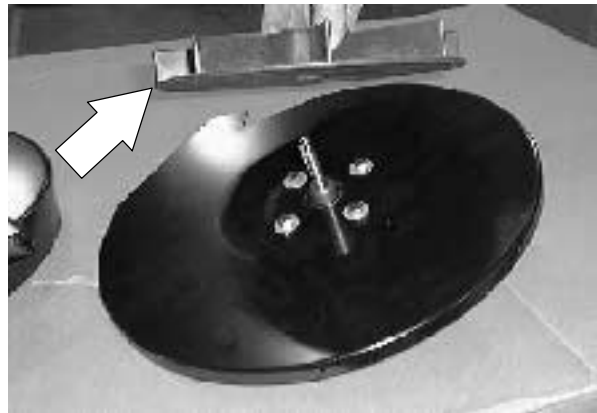

15. Hold the impeller from turning. Install the hex nut on the impeller shaft. Tighten to 18 - 24Nm (15 - 20 ft lb).

16. Reinstall the vacuum fan housing on the bearing backing plate. Hand tighten the smaller hex screws.

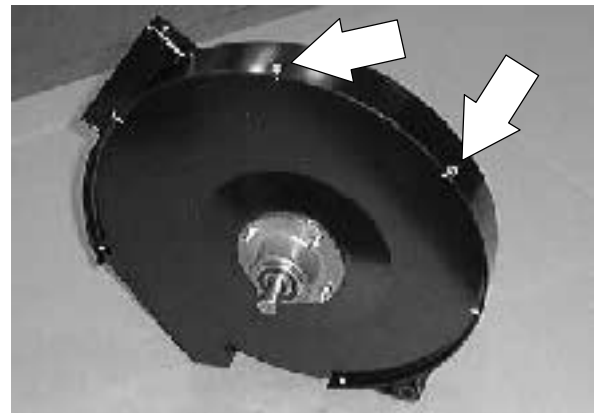

17. Reinstall the vacuum fan assembly in the machine. See TO INSTALL VACUUM FAN ASSEMBLY instructions.

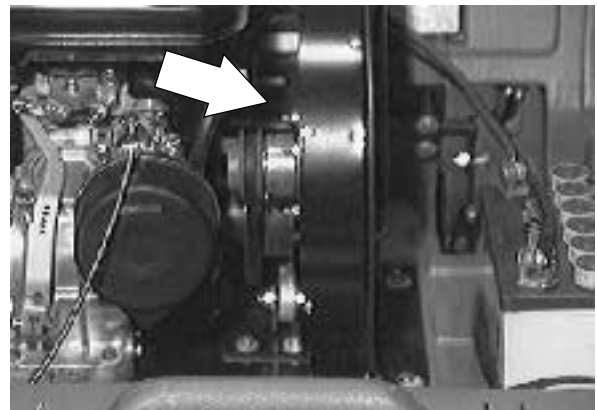

18. Start the machine and check the vacuum fan for proper operation.

**TO TENSION VACUUM FAN V-BELT**

**FOR SAFETY: Before Leaving Or Servicing Machine; Stop On Level Surface, Place Shifter In Park.**

1. Open the engine cover.

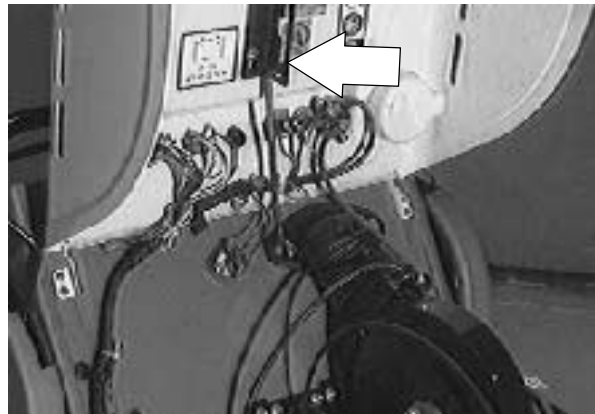

2. Locate the tension bolt and slotted bracket on the side of vacuum fan opposite the V-belt pulley. Loosen the tension bolt.

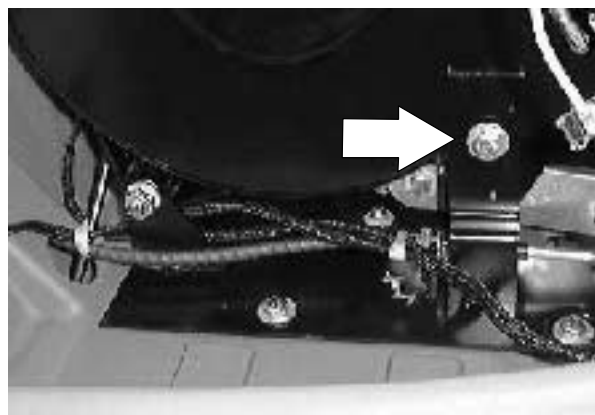

3. Pull up on the vacuum fan assembly until the V-belt is tight. Check belt tension by applying a force 1 kg (2 lb) at belt midpoint. The proper deflection should be 5 mm (0.09 in). Tighten the tension bolt to 18 - 24 Nm (15 - 20 ft lb).

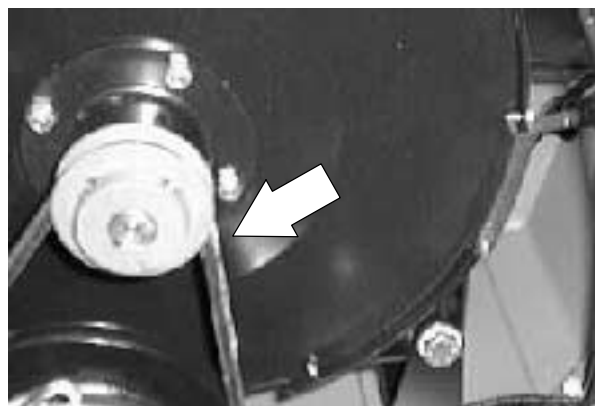

## SWEEPING

4. Close the engine cover.

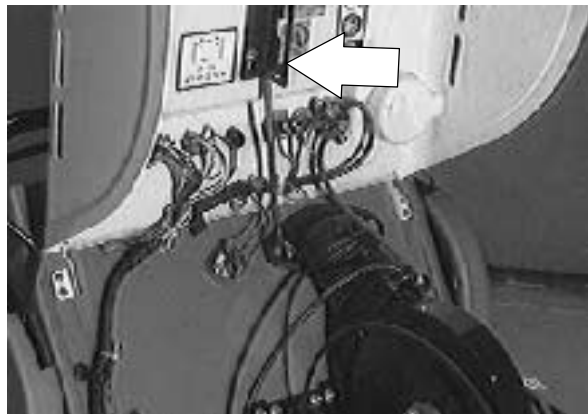

5. Start the machine and check the vacuum fan for proper operation.



**MACHINE TROUBLESHOOTING**

<b>Problem</b>	<b>Cause</b>	<b>Remedy</b>
Excessive dusting	Vacuum hose clogged	Unscrew hose from vac wand handle and clean
	Brush skirts and dust seals worn or damaged	Replace brush skirts or dust seals
	Filter bag full or panel filter clogged	Shake and / or clean or replace bag or panel filter
	Vacuum wand hose damaged	Replace vacuum wand hose
	Vacuum wand not fully inserted into machine	Insert fully
	Vacuum inlet plate clogged	Remove / clean plate. Clean chamber if necessary
	Vacuum fan failure	Contact Tennant service
Poor sweeping performance	Brush bristles worn	Replace brushes
	Main brush not touching floor	Check brush linkage for binding or contact Tennant service personnel
	Main brush not touching carpet	Adjust main brush down pressure
	Debris caught in main brush drive mechanism	Remove debris from drive mechanism
	Main brush drive failure	Contact Tennant service
	Side brush drive failure	Contact Tennant service
	Hopper full	Empty hopper
	Hopper / brush skirts worn or damaged	Replace skirts
	Wrong sweeping brush	Use yellow / black brush w/ 75 mm (3 in) dia tube for floor sweeping Use black brush w/ 125 mm (5 in) dia tube for carpet sweeping
	Rear skirt damaged	Replace skirt
Machine will not propel or shift	Transmission will not go into gear	Contact Tennant service
	Clutch arm not pulling belt tight enough	Adjust clutch cable length
	Propel belt stop bar not adjusted properly	Contact Tennant service
Machine will not start	Thermo Sentry™ tripped	Reset Thermo Sentry™
	Engine oil level low	Check and fill
	Fuel tank valve closed	Open valve - LPG tank valve or valve below gas tank



## CONTENTS

	Page
INTRODUCTION .....	4-3
ELECTRICAL SYSTEM .....	4-4
BATTERY .....	4-4
TO CHARGE BATTERY .....	4-4
TO REPLACE BATTERY .....	4-5
INSTRUMENT PANEL .....	4-7
CIRCUIT BREAKER .....	4-7
TO REPLACE CIRCUIT BREAKER .....	4-8
HOURMETER .....	4-10
FILTER SHAKER MOTOR SWITCH .....	4-10
IGNITION KEY SWITCH .....	4-10
ELECTRIC MOTORS .....	4-11
ELECTRIC MOTOR AMP DRAW	
CHART .....	4-11
TO REPLACE FILTER SHAKER	
MOTOR (OPTION) .....	4-11
TO REPLACE SIDE BRUSH MOTOR .....	4-14
TO REPLACE SIDE BRUSH SWITCH .....	4-17
TO REPLACE RELAY .....	4-21
ELECTRICAL SCHEMATIC/GAS .....	4-23
ELECTRICAL SCHEMATIC/LPG .....	4-24
WIRE HARNESS GAS/LP .....	4-25
TROUBLESHOOTING .....	4-26
ENGINE WILL NOT START .....	4-27
FILTER SHAKER WILL NOT WORK .....	4-28



**INTRODUCTION**

This section includes information on machine electrical components such as relays, circuit breakers, switches, and wiring harness.

## ELECTRICAL SYSTEM

The electrical system on the model 3640G/LP consists of a battery, internal engine alternator, filter shaker motor, side brush motor(s), circuit breakers, relays, and switches.

## BATTERY

The battery on the model 3640 is a 12 volt wet style. It is located in the engine compartment, on the left side of the engine.

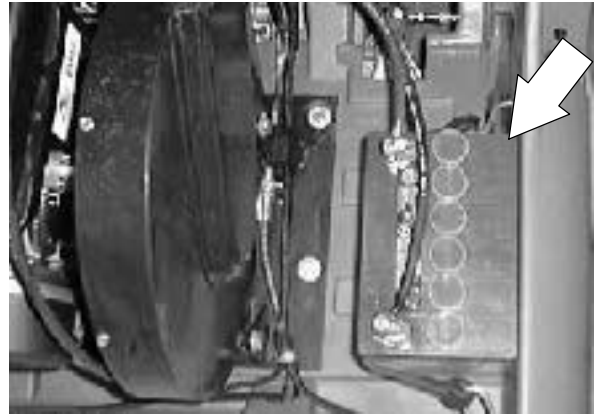

## TO CHARGE BATTERY

**FOR SAFETY: Before Leaving Or Servicing Machine; Stop On Level Surface, Place Shifter In Park.**

1. Open the engine cover and engage the prop rod.

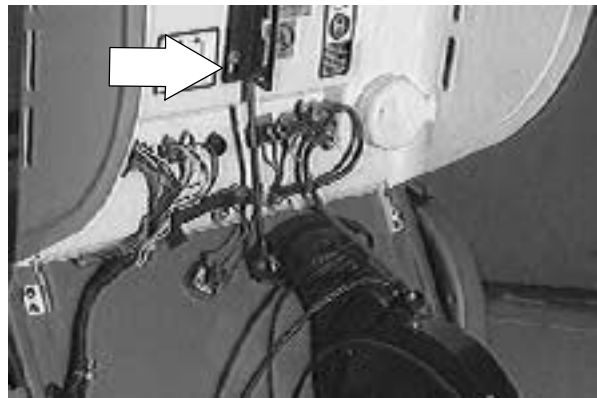

2. Disconnect the battery cables from the battery.
3. Connect the positive cable (red) from the charger to the positive (+) terminal on the battery.
4. Connect the negative cable (black) from the charger to the negative (-) terminal on the battery.
5. Let the battery charger run until the gauge shows that the battery is fully charged.

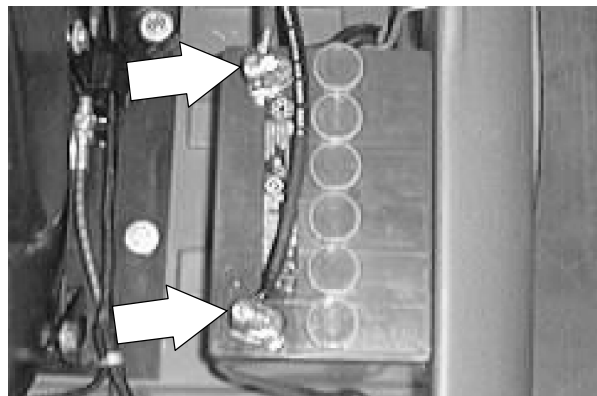

**TO REPLACE BATTERY**

**FOR SAFETY: Before Leaving Or Servicing Machine; Stop On Level Surface, Place Shifter In Park.**

1. Open the engine cover and engage the prop rod.

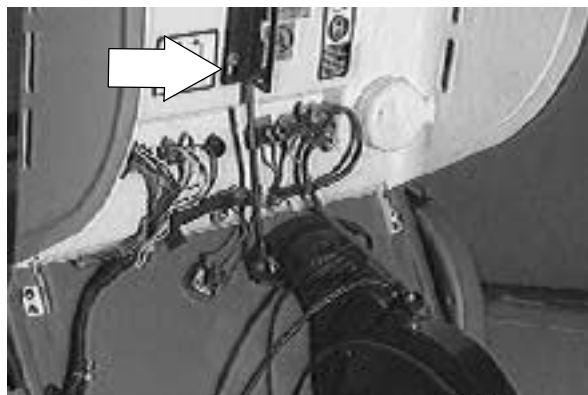

2. Disconnect the battery cables from the battery.

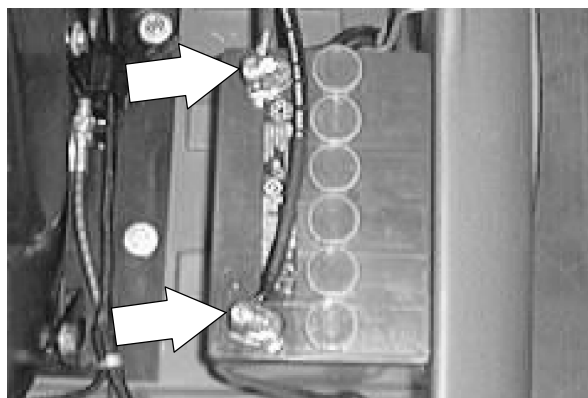

3. Remove the battery hold down strap from the battery. Remove the battery.

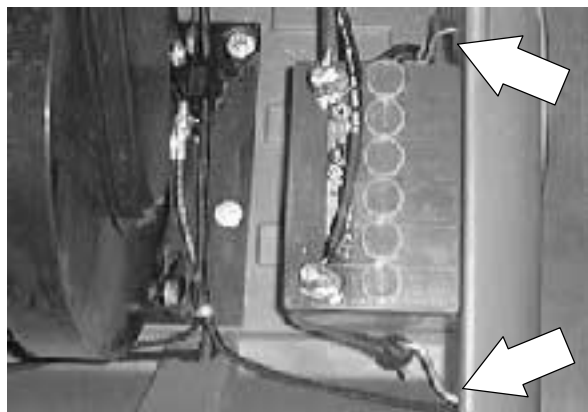

4. Install the new battery in the machine.



5. Install the battery hold down strap.

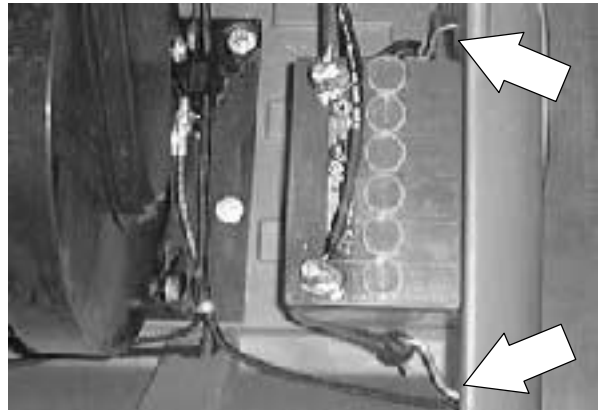

6. Reconnect the battery cables.

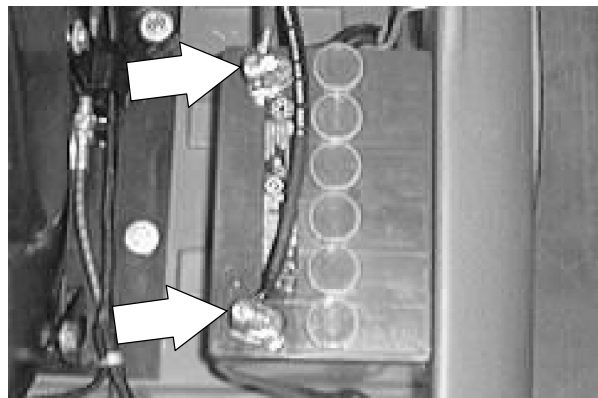



**INSTRUMENT PANEL**

The model 3640 is not equipped with an instrument panel. The gauges, switches, warning lights, and circuit breakers are located on the top of the engine cover. These components can be accessed by lifting the engine cover and engaging the prop rod.



**CIRCUIT BREAKER**

The circuit breaker is a resettable electrical circuit protection device designed to stop the flow of current in the event of a circuit overload. If the circuit breaker is tripped, reset it manually by pressing the reset button after the breaker has cooled down.

If the overload that caused the circuit breaker to trip is still present, the circuit breaker will continue to stop current flow until the problem is corrected.

The circuit breaker is located on the instrument panel.

The chart below shows the circuit breaker and the electrical components it protects.



<b>Circuit Breaker</b>	<b>Rating</b>	<b>Circuits Protected</b>
CB1	15 A	-Ignition -Side brush(es) -Shaker motor

## TO REPLACE CIRCUIT BREAKER

**FOR SAFETY: Before Leaving Or Servicing Machine; Stop On Level Surface, Place Shifter In Park.**

1. Open the engine cover and engage the prop rod.

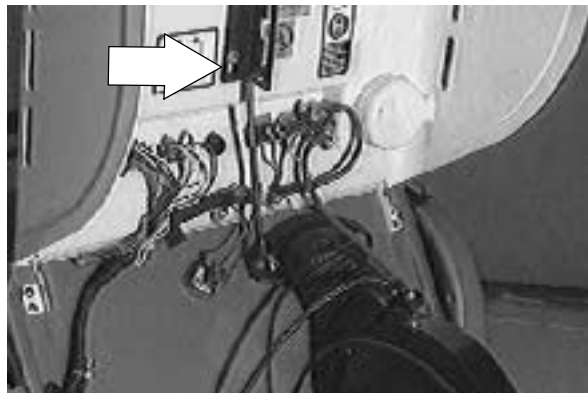

2. Locate the circuit breaker that needs to be changed.



3. Disconnect the wires leading to the back of the circuit breaker.

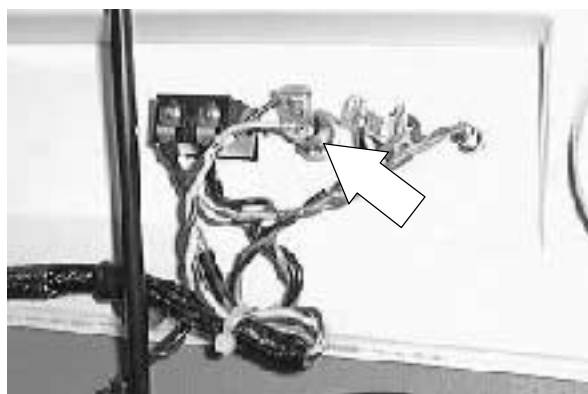

4. Remove the metal lock ring from the back of the circuit breaker. Remove the circuit breaker.
5. Install the new circuit breaker, with the correct 15 amp rating, in the mount hole. Install the lock ring.

*NOTE: The mount hole in the engine cover is "D" shaped. Make sure to install the circuit breaker in the correct orientation.*



6. Reconnect the wires to the back of the new circuit breaker. See schematic in this section.

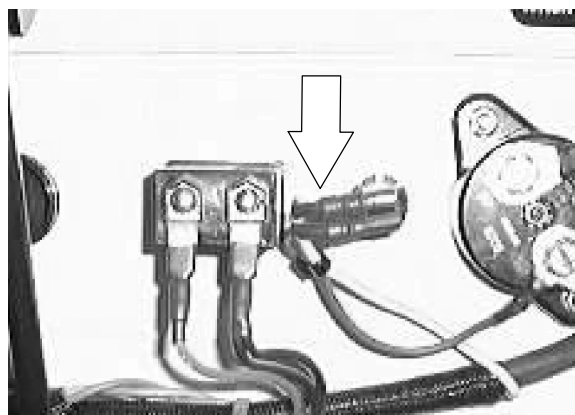

7. Close the engine cover. Start the machine and check the new circuit breaker for proper operation.

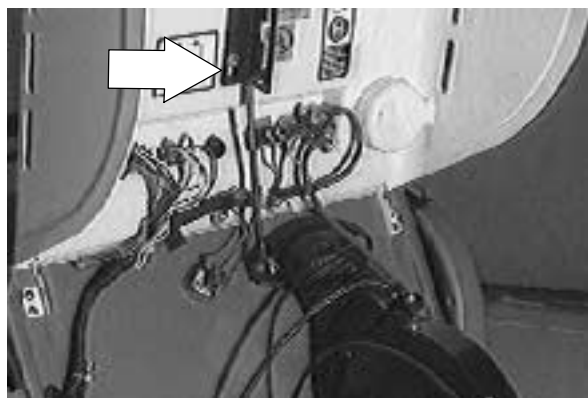

## ELECTRICAL

### HOURLMETER

The hourmeter records the number of hours the machine has been in use. Use this information as a guide as to when to perform routine maintenance.



### FILTER SHAKER MOTOR SWITCH

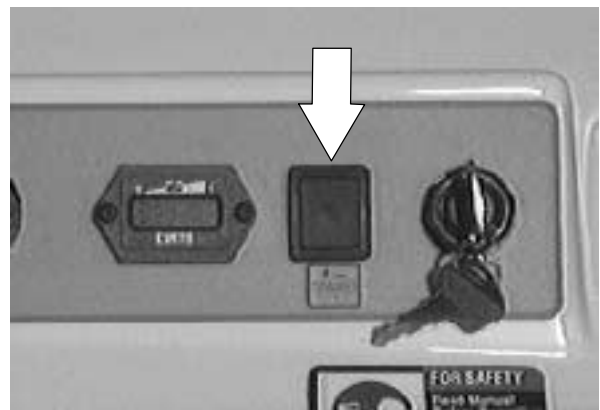

### IGNITION KEY SWITCH

The ignition switch starts and stops the engine using a key.

Start: Turn the engine key clockwise as far as it will go. Release the key as soon as the engine starts.

Stop: Turn the engine key counterclockwise.



## ELECTRIC MOTORS

Check the side brush motor(s) brushes every 500 hours of operation. Replace the motor brushes when they are worn 9 mm (.375 in).

### ELECTRIC MOTOR AMP DRAW CHART

● SIDE BRUSH MOTOR (NO LOAD)	▶ APPROX. 3 DC AMPS
● SIDE BRUSH MOTOR (FREE FLOAT ON URETHANED CONCRETE)	▶ APPROX. 4 DC AMPS

### TO REPLACE FILTER SHAKER MOTOR (OPTION)

**FOR SAFETY: Before Leaving Or Servicing Machine; Stop On Level Surface, Place Shifter In Park.**

1. Open the engine cover and engage the prop rod.

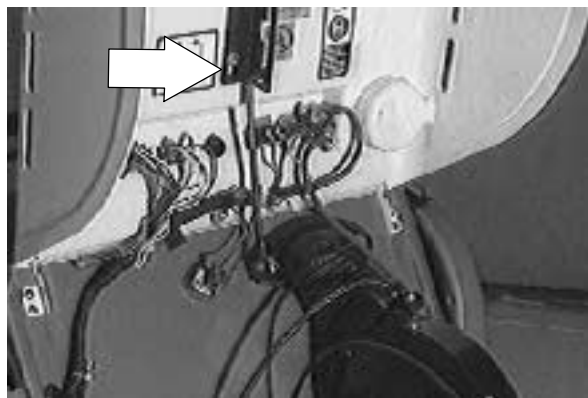

2. Disconnect the battery cables from the battery.

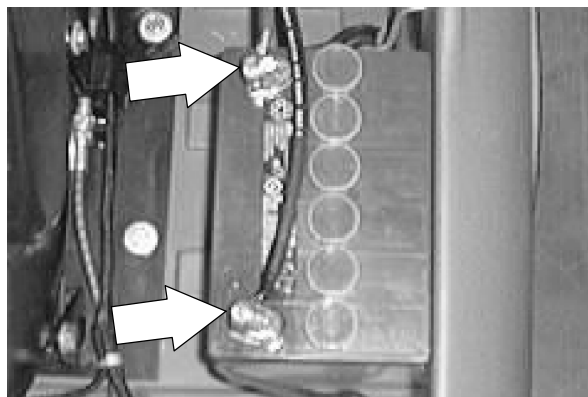

## ELECTRICAL

3. Locate the shaker motor on the back wall, behind the engine.

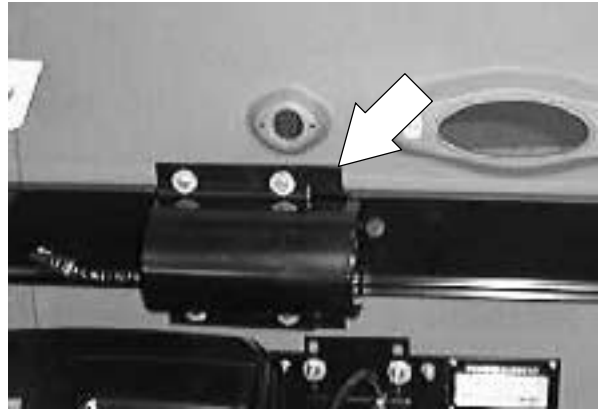

4. Disconnect the electrical plug leading to the shaker motor.

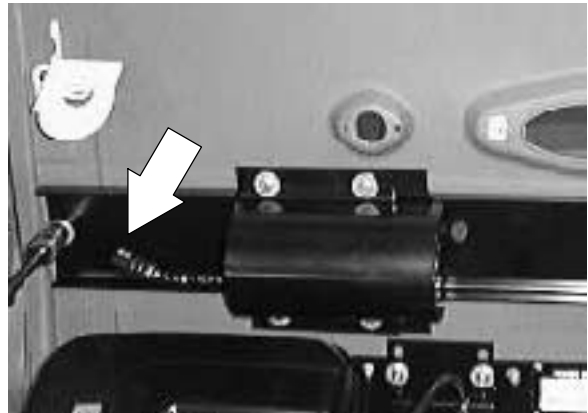

5. Remove the hex screws holding the shaker motor mount bracket to the frame bracket. Remove the shaker motor from the machine.

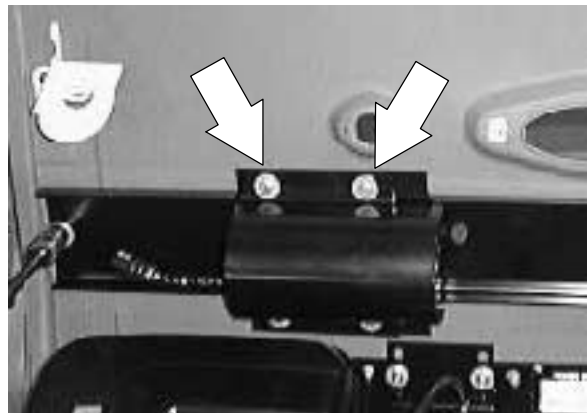

6. Loosen the two set screw holding the weight to the motor shaft. Slide the weight off and install it on the new motor in the same orientation. Firmly tighten the set screws.



7. Install the new shaker motor in the machine. Position it on the frame bracket and install the mount bracket. Tighten the hex screws to 18 - 24 Nm (15 - 20 ft lb).

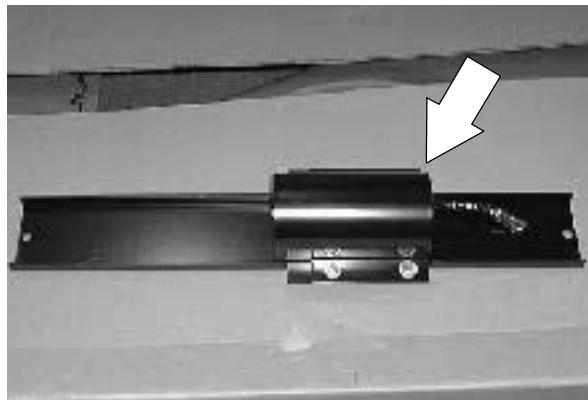

8. Plug the new shaker motor into the main electrical harness. See schematic in this section.

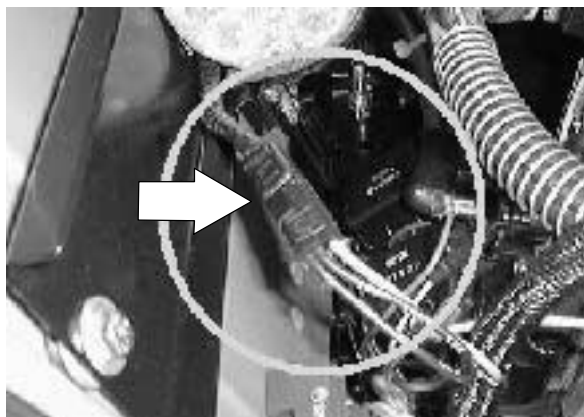

9. Reconnect the battery cables.

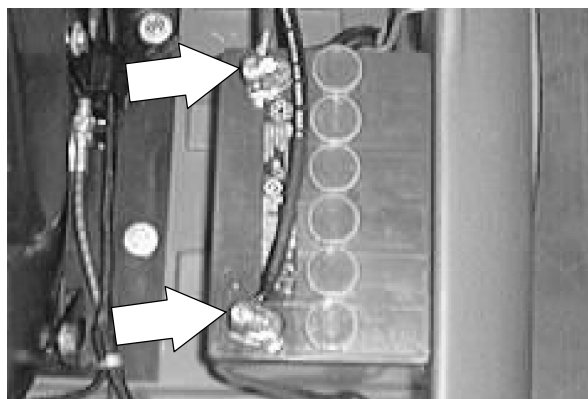

10. Close the engine cover. Start the machine and check the new shaker motor for proper operation.

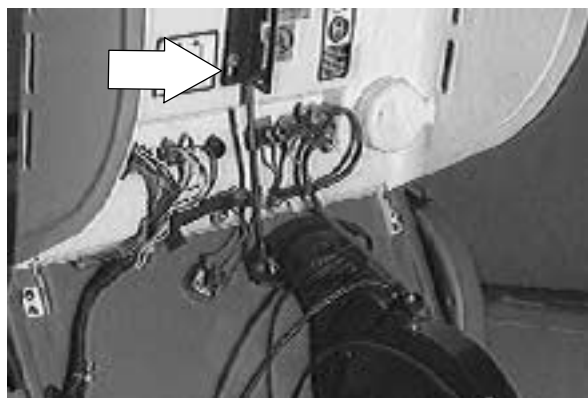

## TO REPLACE SIDE BRUSH MOTOR

**FOR SAFETY: Before Leaving Or Servicing Machine; Stop On Level Surface, Place Shifter In Park.**

1. Open the engine cover and engage the prop rod.

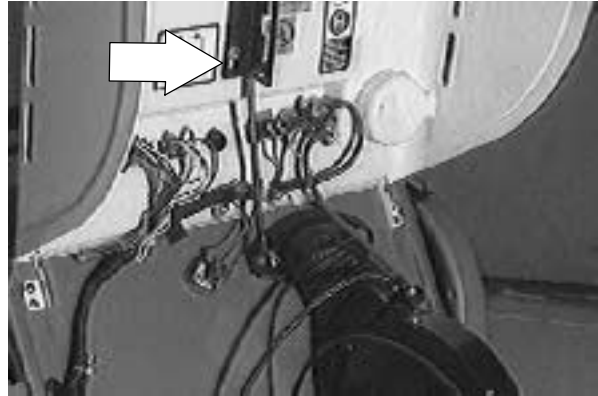

2. Disconnect the battery cables from the battery.

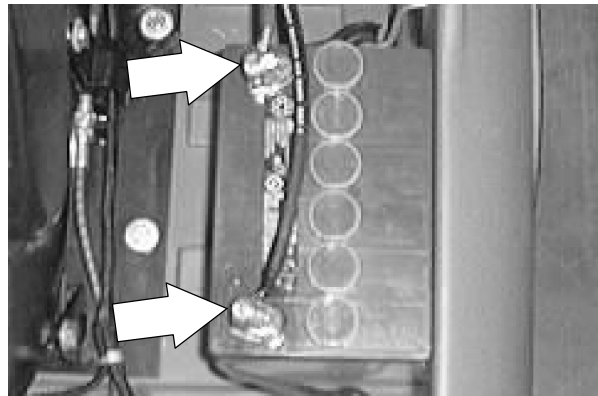

3. Remove the RH side brush. See TO REPLACE LH OR RH SIDE BRUSH instructions in the SWEEPING section.

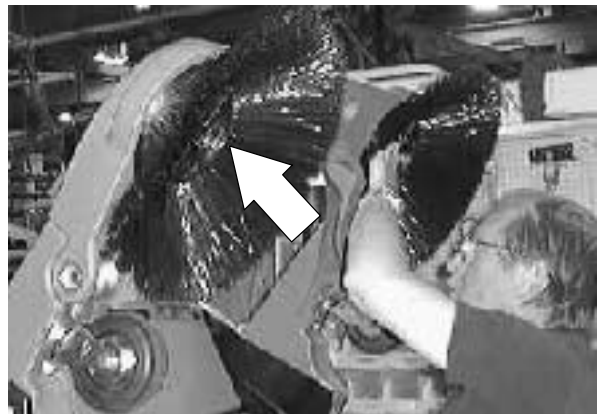



4. Un-plug the RH side brush motor from the main electrical harness.

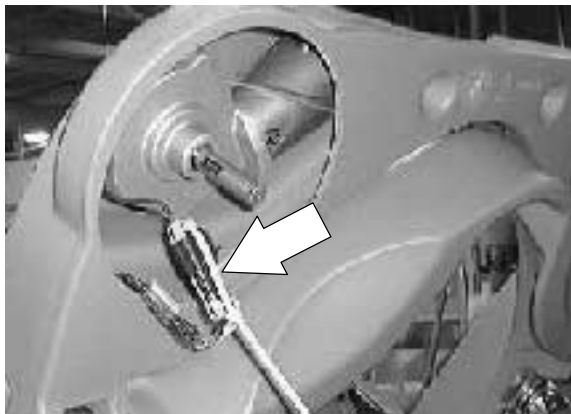

5. Remove the four hex screws holding the side brush motor and gear box to the machine frame.



6. Remove the side brush motor and gear box from the machine.



7. Position the new side brush motor and gear box in the machine. Line up the mount holes in the machine frame with the mount holes in the side brush motor.

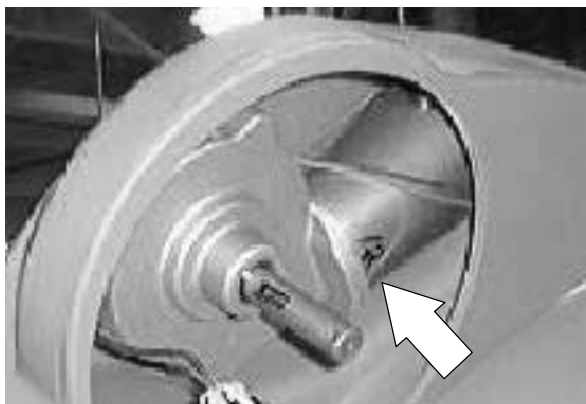

## ELECTRICAL

8. Reinstall the four hex screws and tighten to 7.6 - 9.9 Nm (6 - 8 ft lb).

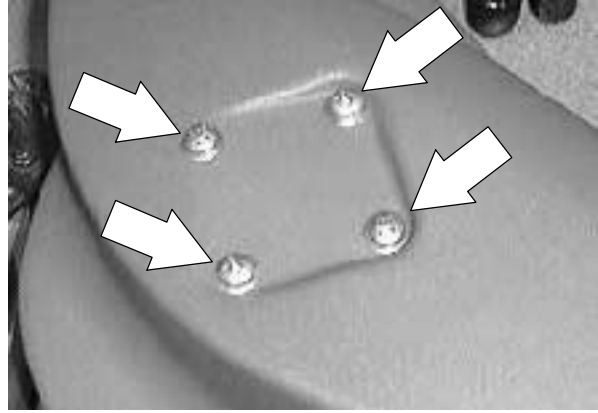

9. Reconnect the RH side brush motor to the main harness. See schematic in the ELECTRICAL section.

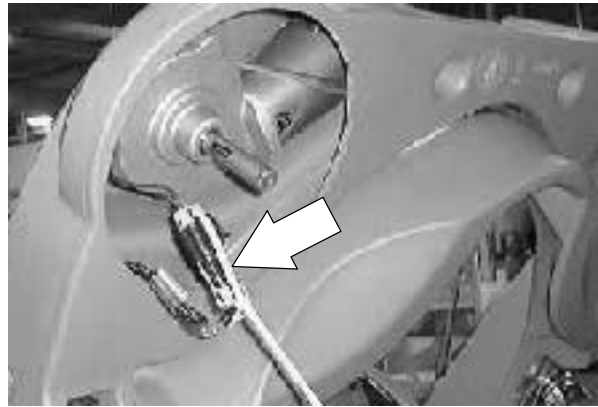

10. Reinstall the side brush. See TO REPLACE LH OR RH SIDE BRUSH instructions in the SWEEPING section.

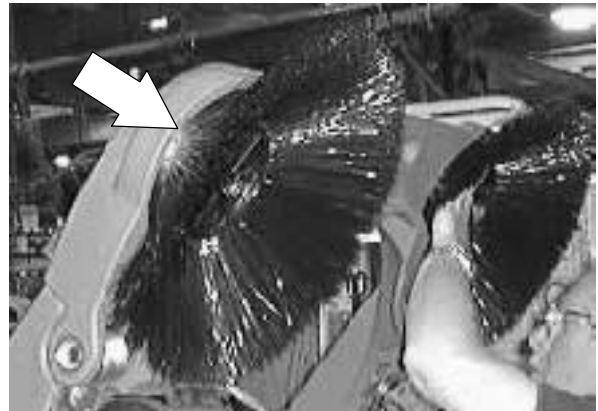

11. Reconnect the battery cables.

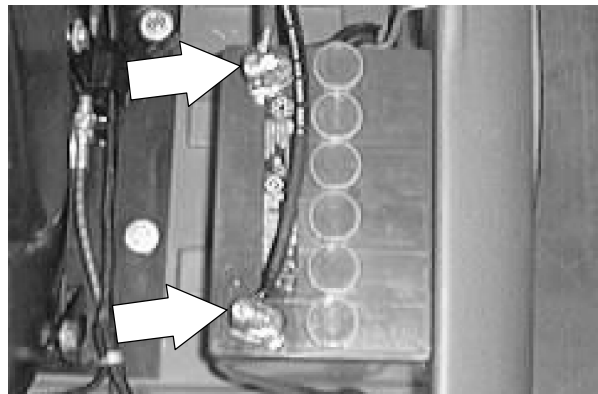

12. Close the engine cover. Start the machine and check the new RH side brush motor for proper operation.

**TO REPLACE SIDE BRUSH SWITCH**

**FOR SAFETY: Before Leaving Or Servicing Machine; Stop On Level Surface, Place Shifter In Park.**

1. Remove the filter cover from the rear of the machine.



2. Remove the handle stop bracket from the upper/left side of the filter compartment.

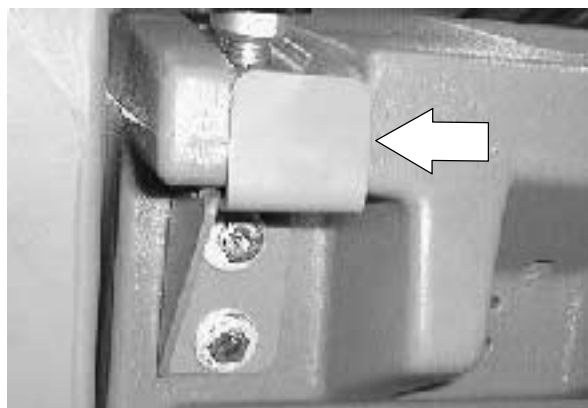

3. Pull up on the two handle locks and move the handle assembly to its lowest position.

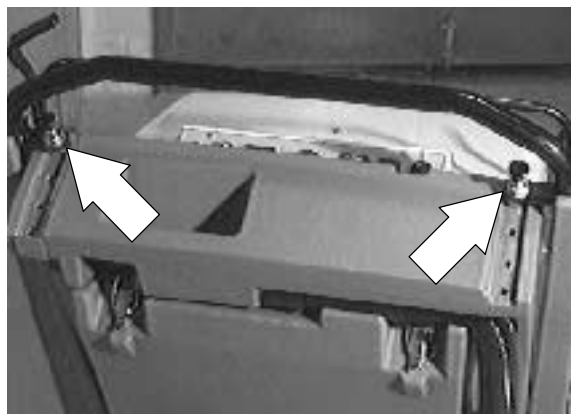

## ELECTRICAL

4. Remove the three flat screws holding the cover plate to the inside of the right side handle tower. Remove the cover plate from the machine.

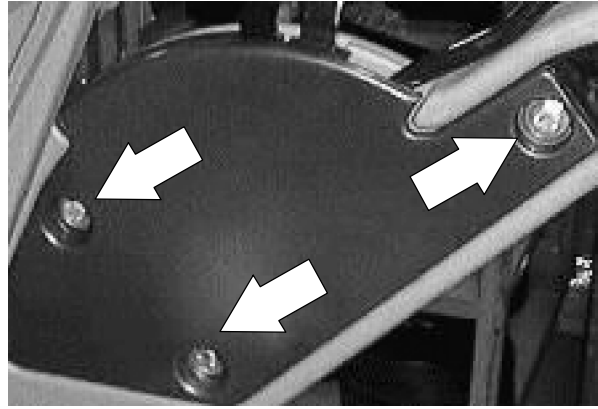

5. Remove the hardware and pull the brush handle mount plate away from the right plastic handle.

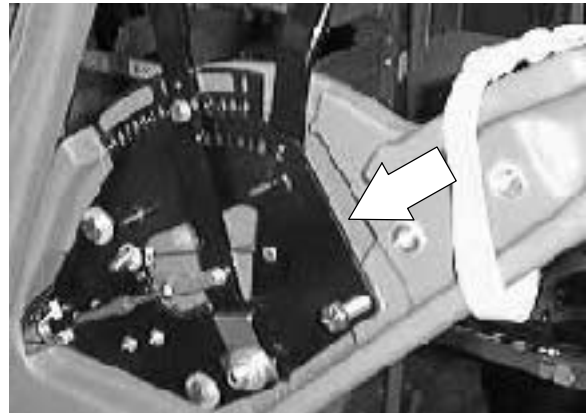

6. Mark and disconnect the wires leading to the side brush switch.

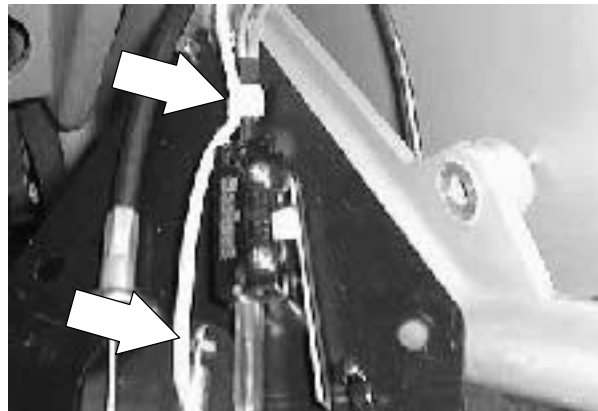

7. Remove the two screws and nuts holding the switch to the brush handle mount plate. Remove the side brush switch from the machine.

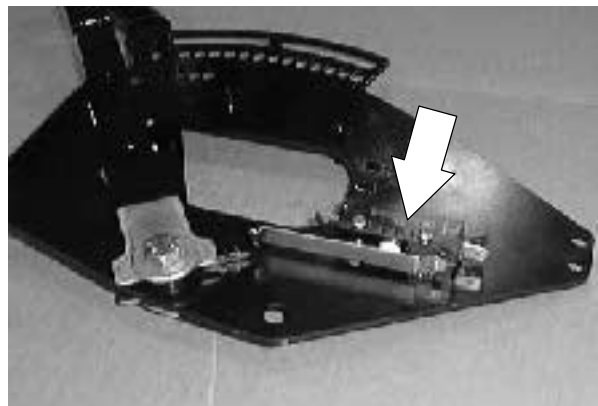

8. Install the new switch on the brush handle mount plate in the same orientation as the old one. Reinstall the two screws and nuts. Hand tighten lightly.

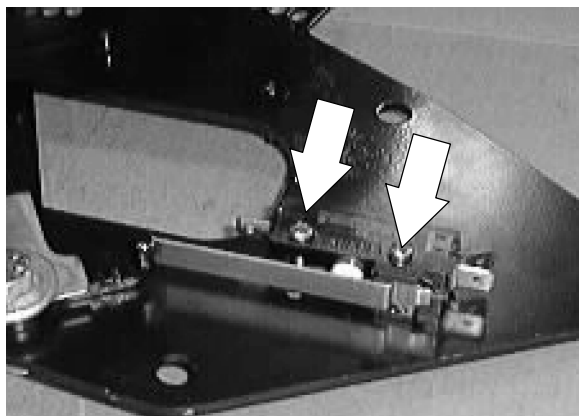

9. Reconnect the wires to the new side brush switch. See schematic in this section.

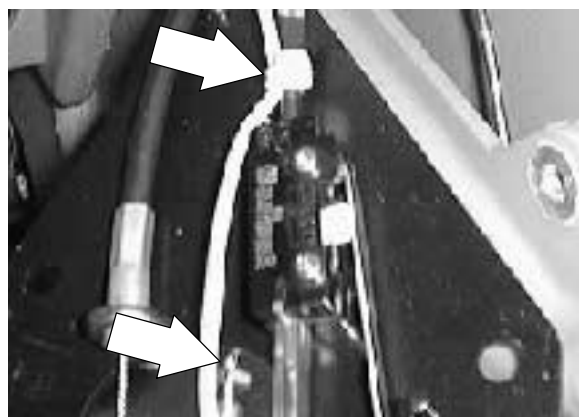

10. Position the brush handle mount plate against the right plastic handle. Reinstall the hardware.

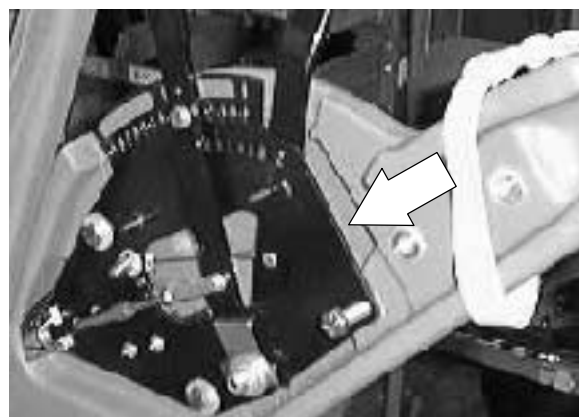

11. Reinstall the right side handle assembly cover plate. Tighten the three flat screws to 18 - 24 Nm (15 - 20 ft lb).

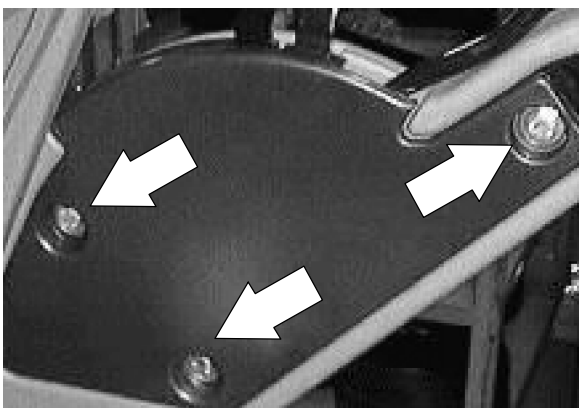

12. Move the handle assembly up to one of the four adjustment holes.

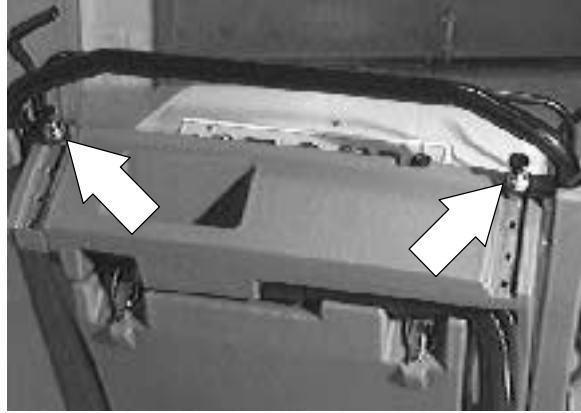

13. Reinstall the filter cover.

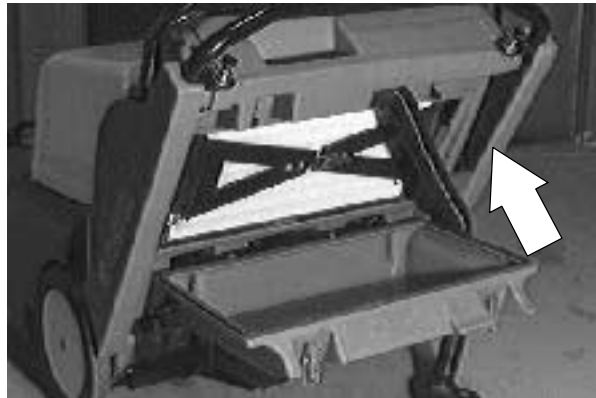

14. Reinstall the handle stop bracket.

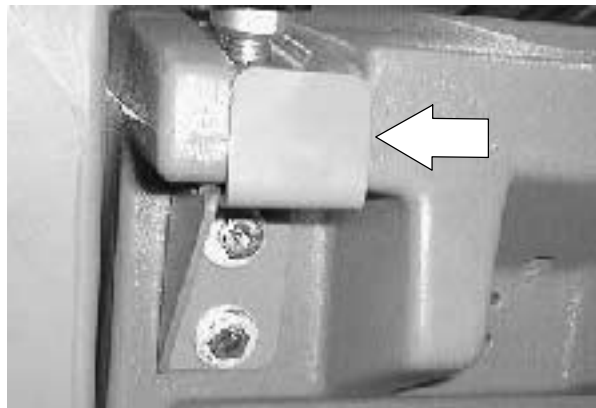

15. Start the machine and check the side brush for proper operation when the handle is placed in the down position.

**TO REPLACE RELAY**

**FOR SAFETY: Before Leaving Or Servicing Machine; Stop On Level Surface, Place Shifter In Park.**

1. Open the engine cover and engage the prop rod.

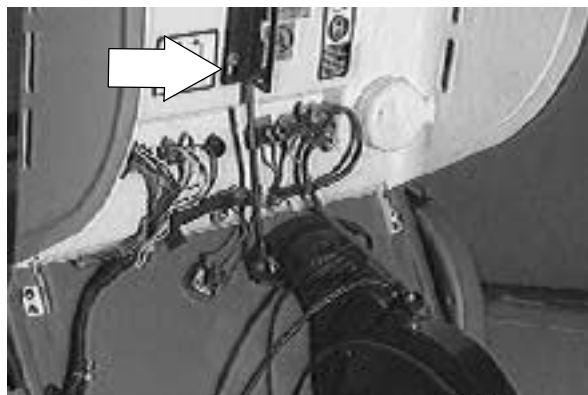

2. Disconnect the battery cables from the battery.

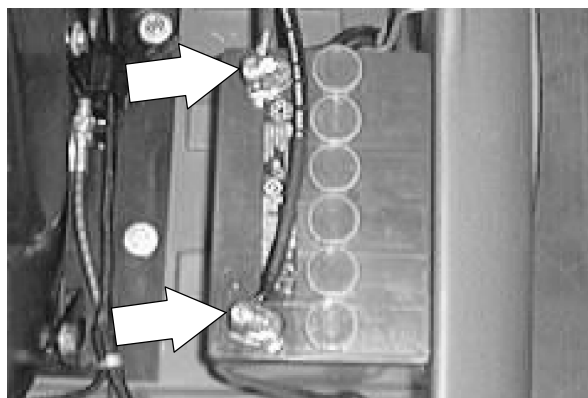

3. Locate the relay block on the back wall, behind the engine.



## ELECTRICAL

4. Pull the defective relay up and out of the relay block. *You may need to use a small screw driver to pry the relay out of the terminals.*

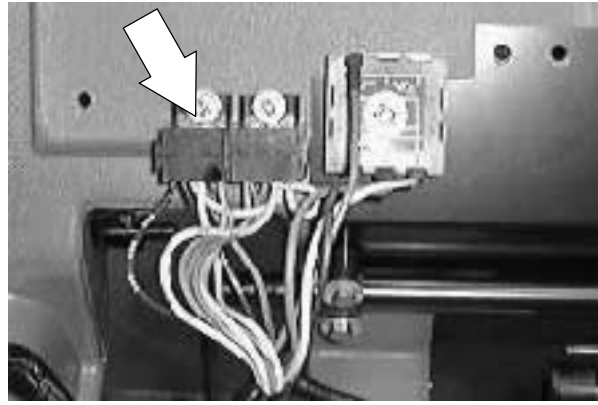

5. Install the new relay in the relay block. Note the direction of the terminals on the relay for proper installation. Push the relay in all the way.

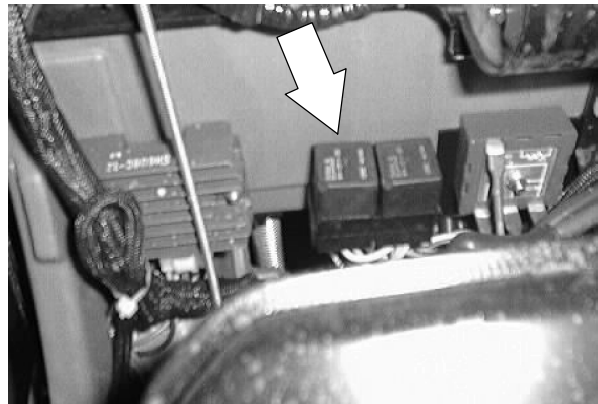

6. Reconnect the battery cables.

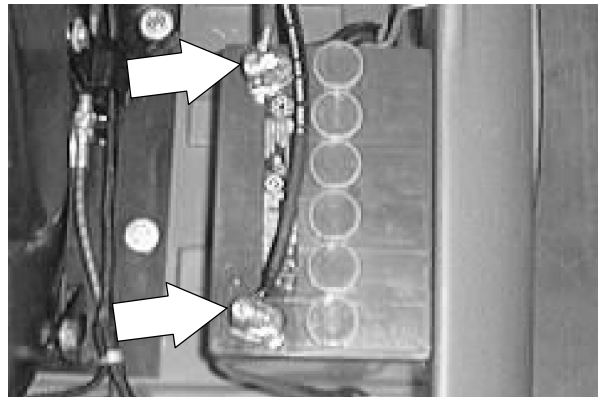

7. Close the engine cover. Start the machine and check the new relay for proper operation.

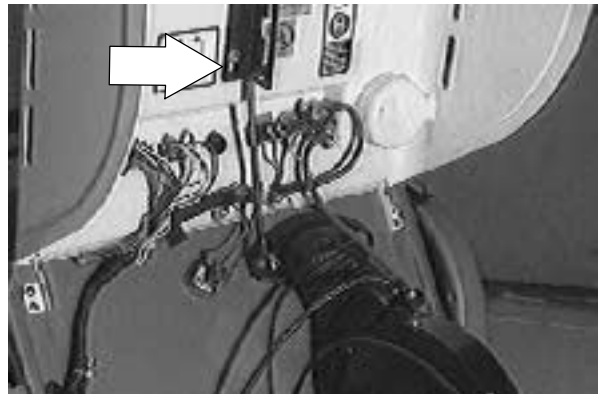



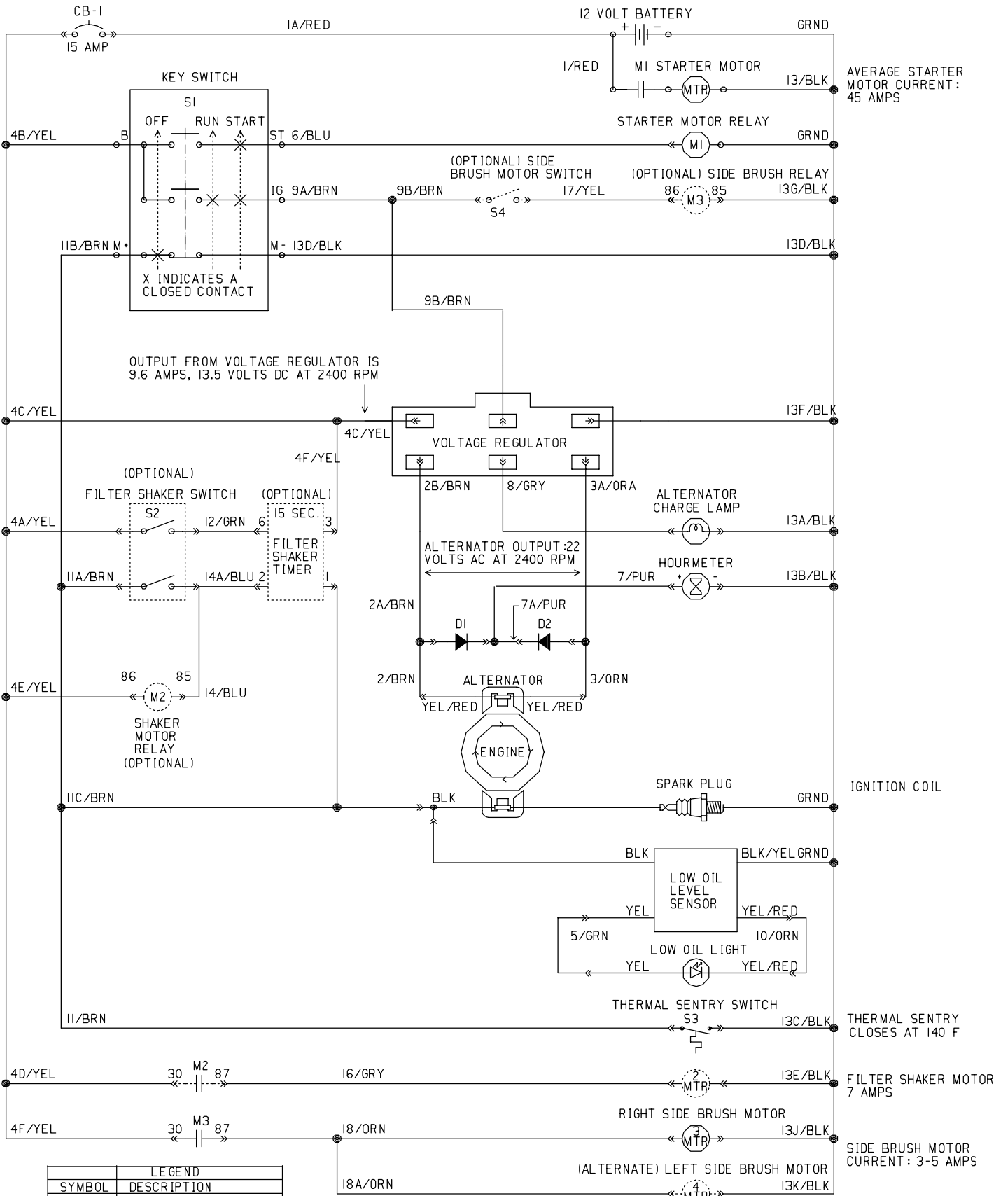

LEGEND	
SYMBOL	DESCRIPTION
CB	CIRCUIT BREAKER
D	DIODE
GRND	GROUND
M	RELAY OR CONTACTOR
MTR	MOTOR
SW	SWITCH

350890

## ELECTRICAL SCHEMATIC/GAS

Fig. 21 - Electrical Schematic LPG

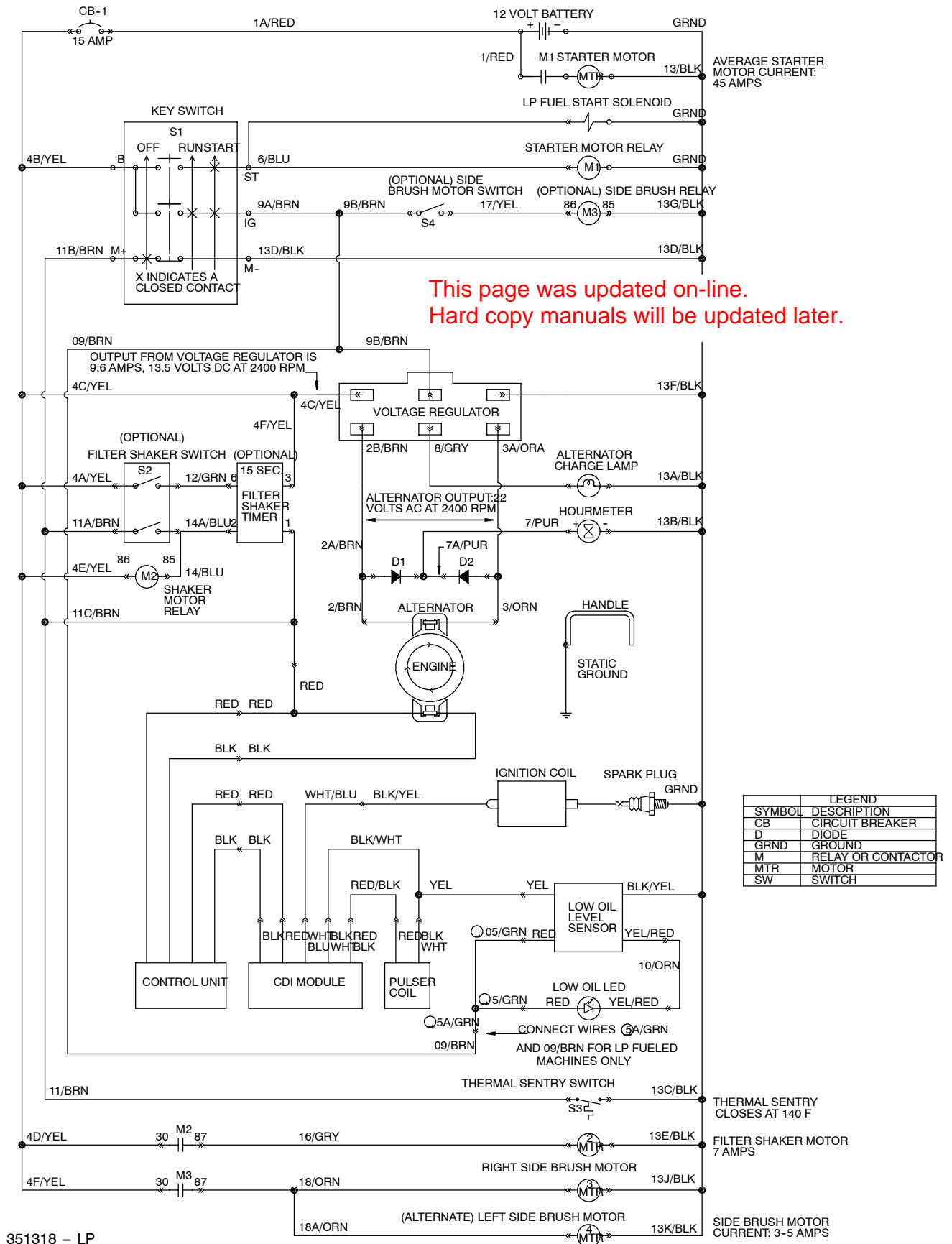

This page was updated on-line.  
Hard copy manuals will be updated later.

351318 - LP

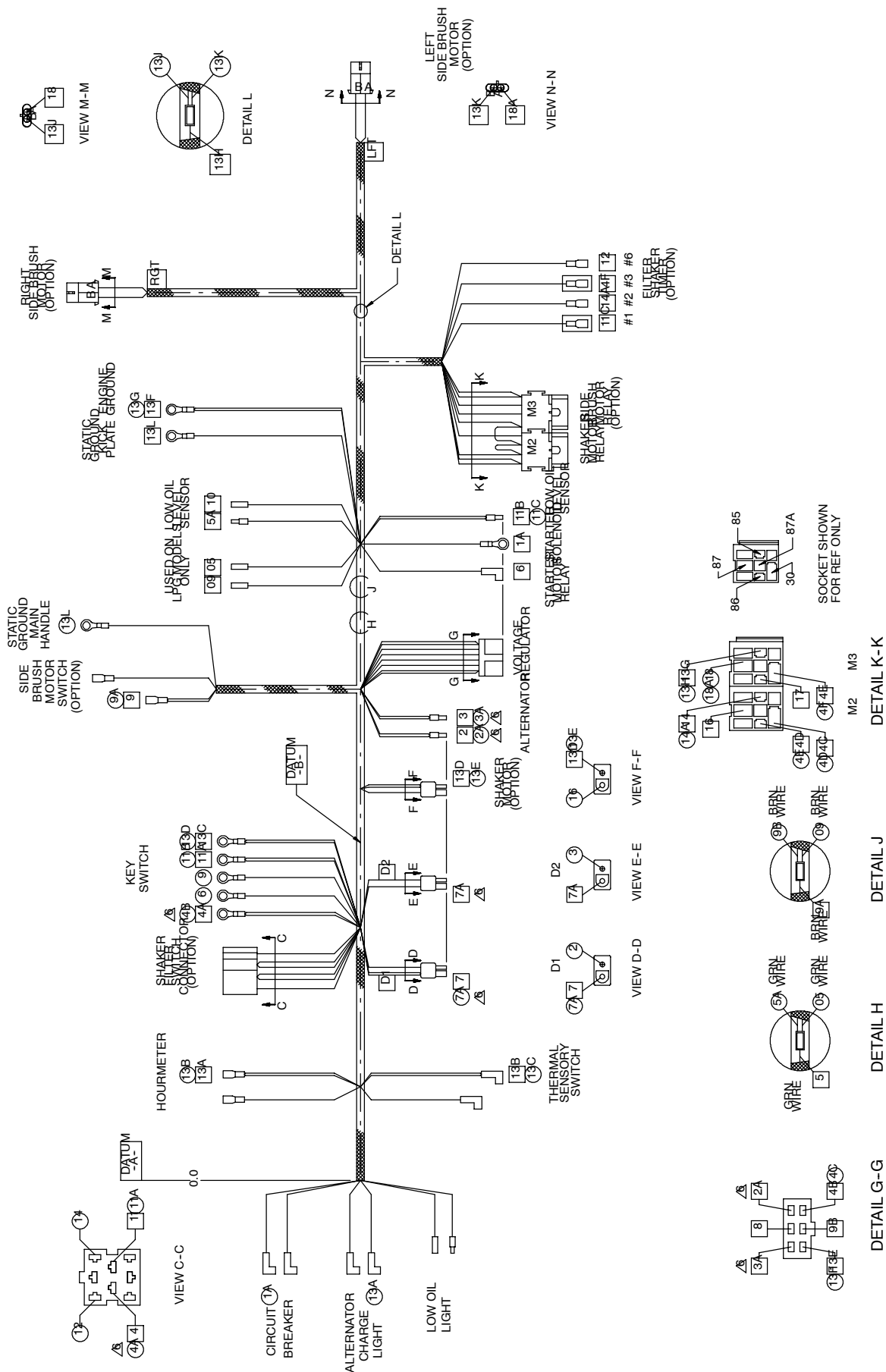

WIRE HARNESS GAS/LP

## TROUBLESHOOTING

The troubleshooting flow charts that follow are organized so they lead you through the circuits. They include flow charts and instructions for you as to where to insert your test instruments.

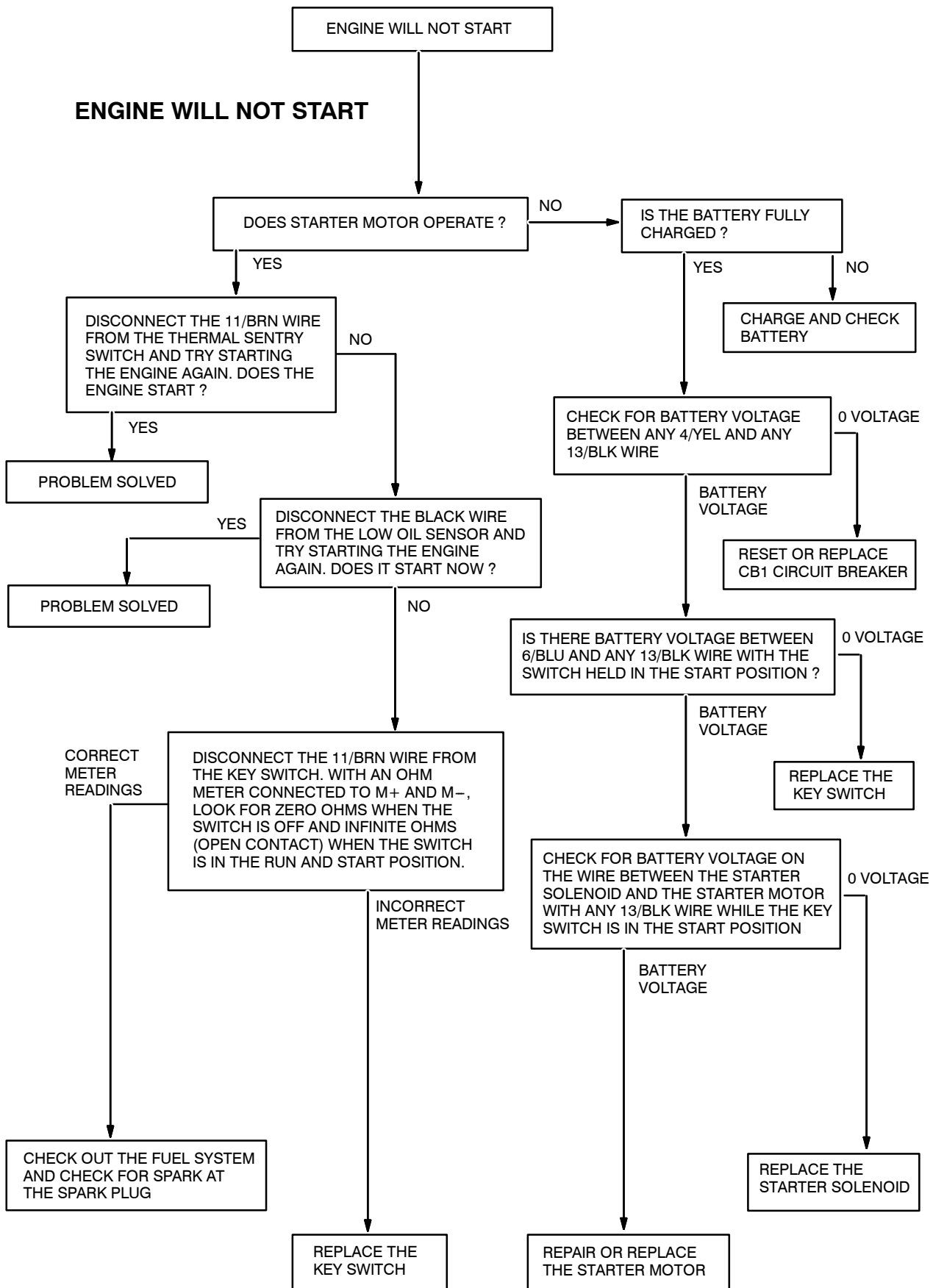

## FILTER SHAKER WILL NOT WORK

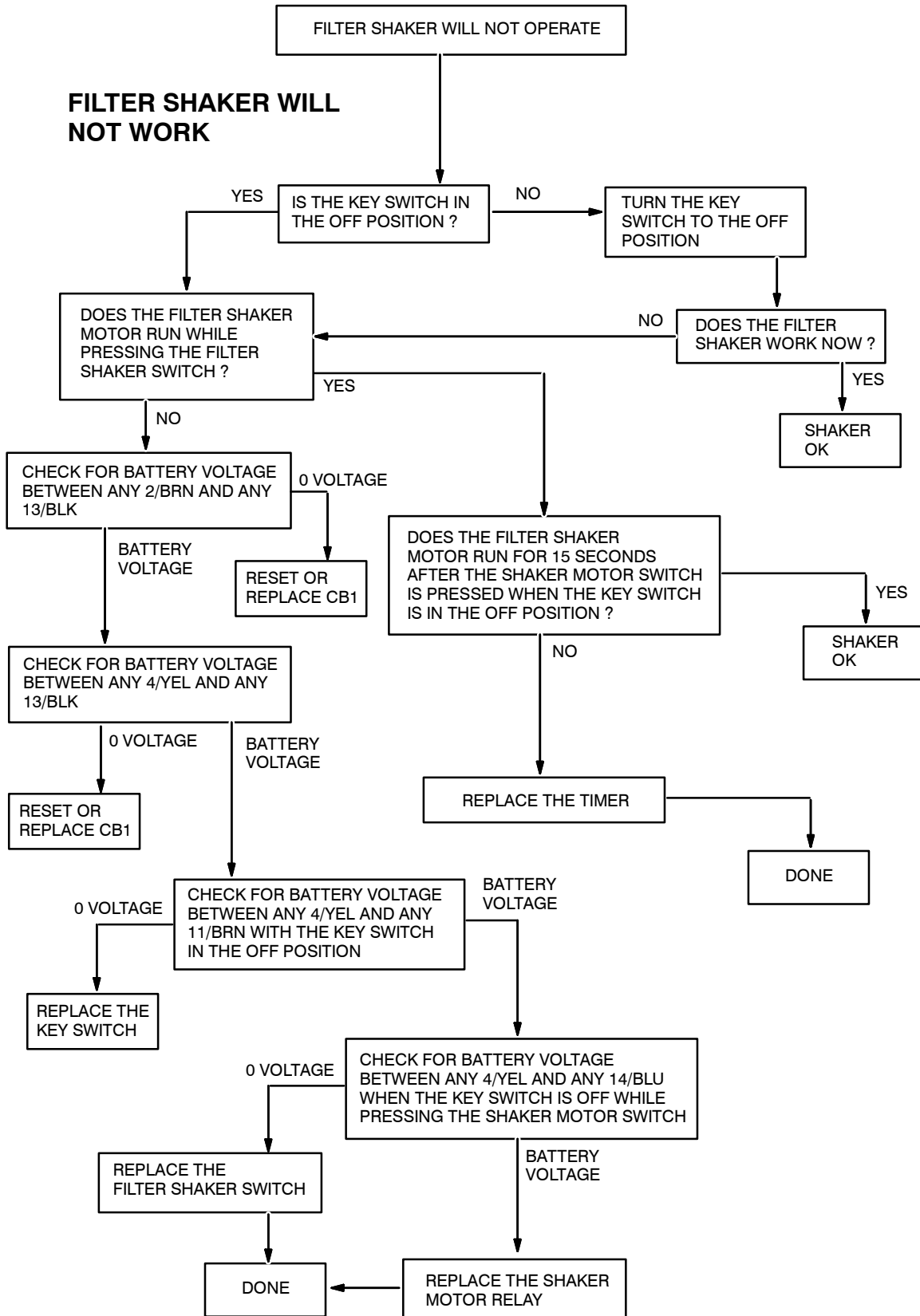

**CONTENTS**

	Page
INTRODUCTION .....	5-3
LUBRICATION .....	5-4
TO CHANGE ENGINE OIL .....	5-4
LOW OIL WARNING INDICATOR ....	5-5
AIR INTAKE SYSTEM .....	5-6
TO REPLACE AIR FILTER .....	5-6
COOLING SYSTEM .....	5-8
GOVERNOR .....	5-8
FUEL SYSTEM - GASOLINE .....	5-9
FUEL FILTER .....	5-9
TO CLEAN FUEL TANK SEDIMENT	
BOWL .....	5-10
GAS CARBURETOR .....	5-11
FUEL SYSTEM - LPG .....	5-12
LP FUEL TANK .....	5-12
TO CHANGE LPG FUEL TANK ..	5-12
ENGINE CHOKE KNOB .....	5-14
LP CARBURETOR .....	5-14
LP LOCK-OFF/FILTER .....	5-14
LP REGULATOR .....	5-14
IGNITION SYSTEM .....	5-15
SPARK PLUG .....	5-15
TO REPLACE SPARK PLUG ....	5-15
ALTERNATOR .....	5-16
LOW BATTERY CHARGE	
INDICATOR .....	5-16
TO REPLACE STARTER .....	5-17
TO REMOVE ENGINE .....	5-20
TO INSTALL ENGINE .....	5-24

**GAS ENGINE SERVICE MANUAL****ROBIN EH17****TENNANT Part Number 393944**





**INTRODUCTION**

This section includes repair information on the engine and related systems, such as fuel, electrical, and drive belts. This section includes information on the gas and LP engines.

### LUBRICATION

---

The lubrication system on the model 3640 is a splash style. There is no oil filter or oil pump on this engine.

#### TO CHANGE ENGINE OIL

**FOR SAFETY: Before Leaving Or Servicing Machine; Stop On Level Surface, Place Shifter In Park.**

1. Open the engine cover and engage the prop rod.

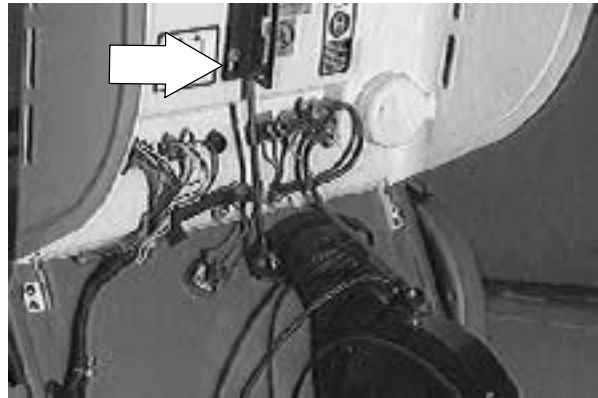

2. Go to the rear of the machine and locate the engine oil drain plug on the right hand side, above the brush arm bracket.



3. Slide a drain pan under the brush arm bracket in the area below the drain plug.

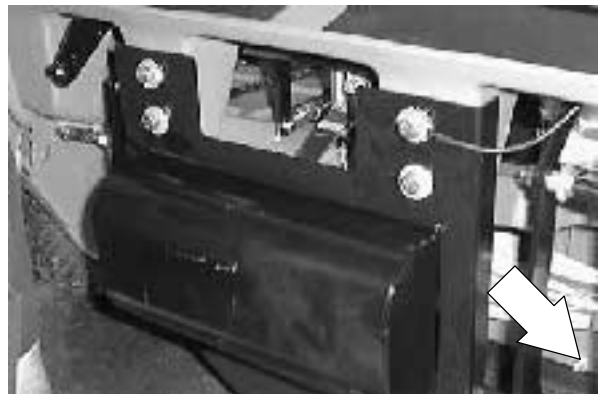

4. Remove the drain plug from the engine. Let the oil drain completely.
5. Reinstall the drain plug. Tighten firmly.

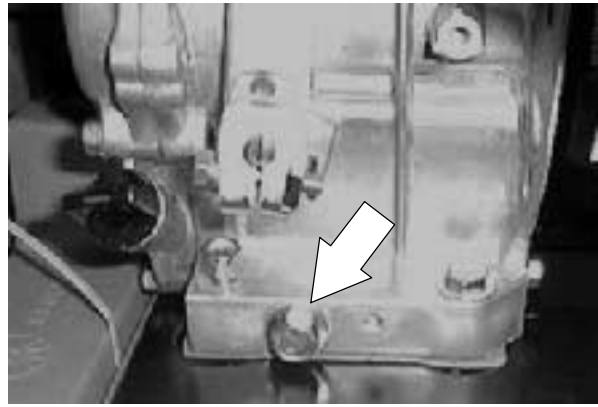

6. Fill the engine with oil. The capacity of this engine is 0.65 liters (0.17 U. S. gallon). Use an automobile grade SAE #20, #30, or 10W-30

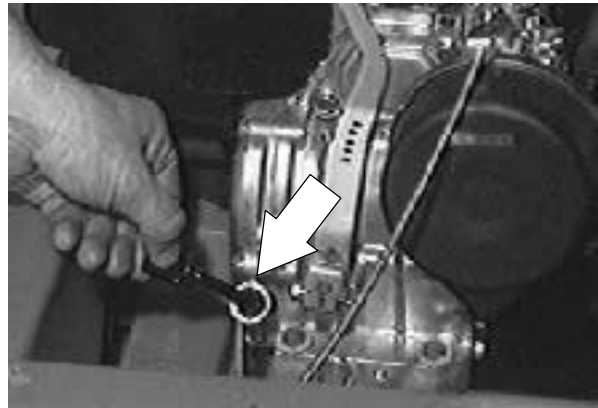

7. Change the engine oil after the first 20 hours of operation and every 50 hours after that.

### LOW OIL WARNING INDICATOR

Gasoline and LPG powered machines: A low oil shutdown switch is standard equipment on all gasoline and LP gas powered machines. When the engine oil level drops below a certain level, the engine will automatically shut itself off. The engine will not restart until the proper amount of oil has been added to it.

If the low oil engine shutdown switch has been activated and the engine has turned itself off, the low oil warning indicator will illuminate.



## AIR INTAKE SYSTEM

The air intake system on the model 3640 consists of an carburetor mounted air filter. The cover over the filter can be removed for access to the filter for cleaning or replacement.

### TO REPLACE AIR FILTER

**FOR SAFETY: Before Leaving Or Servicing Machine; Stop On Level Surface, Place Shifter In Park.**

1. Open the engine cover and engage the prop rod.

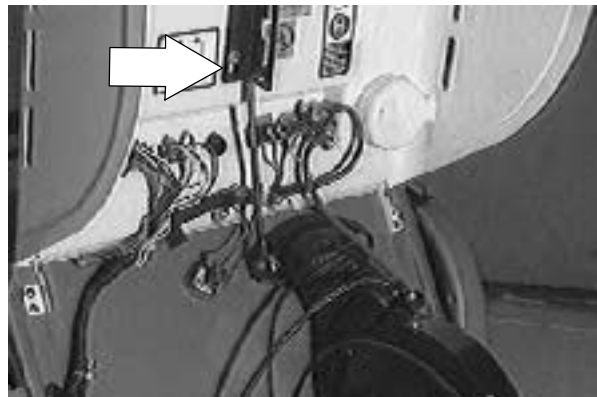

2. Locate the air filter cover on the front of the engine.

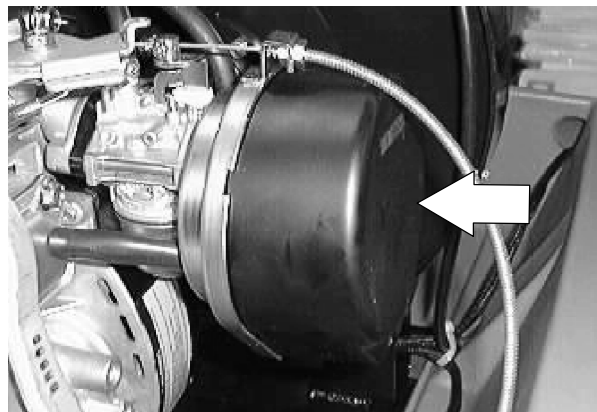

3. Un-snap the clamp holding the filter cover to the carburetor mount plate.

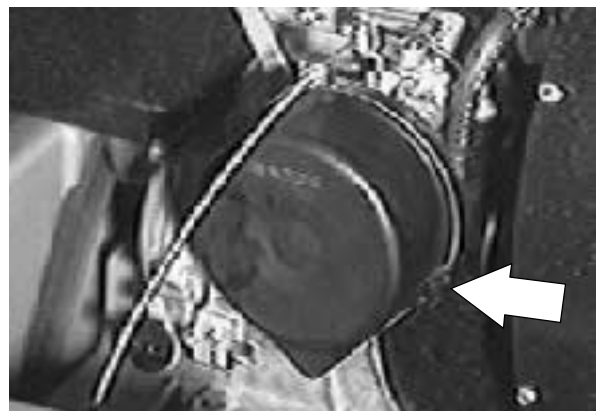

4. Remove the filter cover and dirty filter.
5. Install the new air filter and existing filter cover on the mount plate.

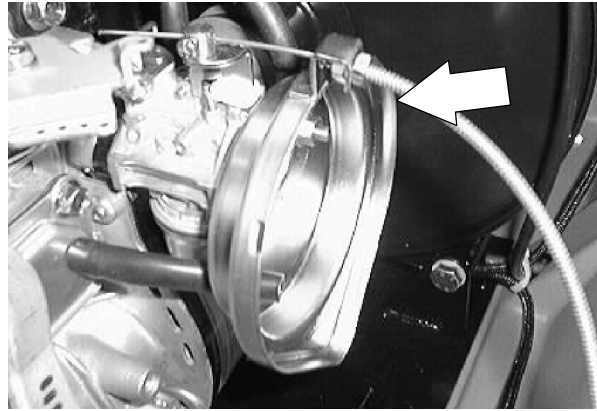

6. Reconnect the filter cover clamp and snap in place.

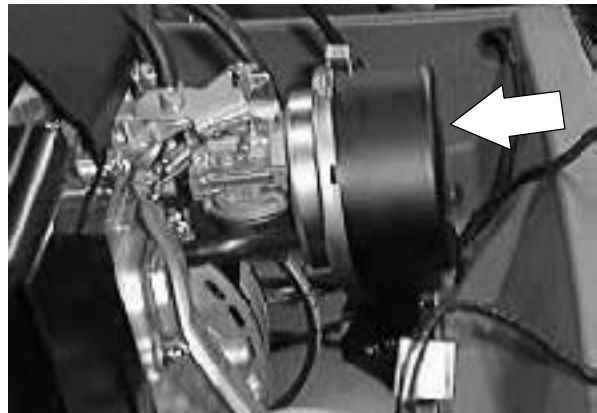

7. Close the engine cover and operate the machine.

### COOLING SYSTEM

---

The engine on the model 3640 uses a forced air cooling system. Every 100 to 200 hours the blower housing on the engine should be removed so the area between the cooling fins can be clean of any dirt or debris.

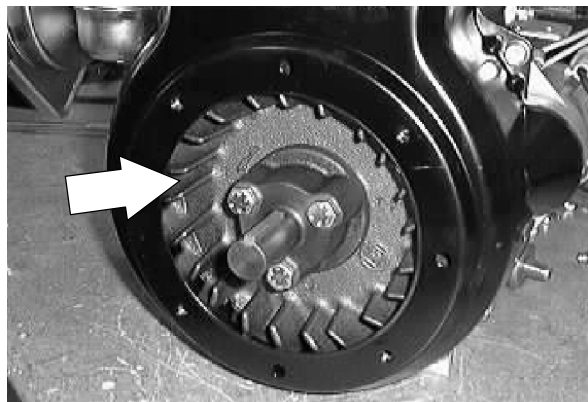

### GOVERNOR

---

The governor on the model 3640 is an internal mechanical style using a centrifugal flyweight system. It requires no regular maintenance or adjustment.



---

**FUEL SYSTEM - GASOLINE**

---

The gas fuel system on the model 3640 is a gravity feed type. There is no fuel pump on this engine. The fuel tank holds 3.6 liters (0.95 gallons).

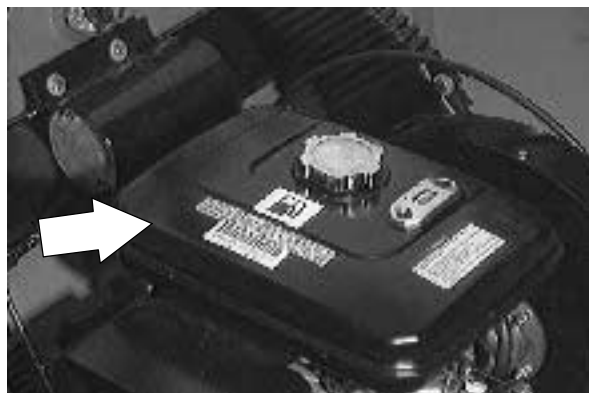
**FUEL FILTER**

The engine on the model 3640 does not have an in-line fuel filter. This engine is equipped with a sediment bolt at the fuel tank shut-off valve. Clean the sediment bowl every 100 to 200 hours.

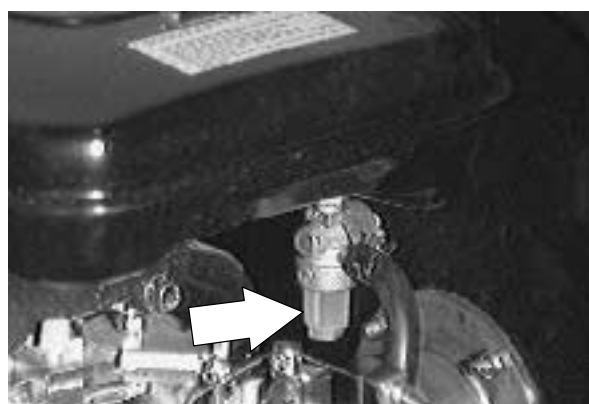

### TO CLEAN FUEL TANK SEDIMENT BOWL

**FOR SAFETY: Before Leaving Or Servicing Machine; Stop On Level Surface, Place Shifter In Park.**

1. Open the engine cover and engage the prop rod.

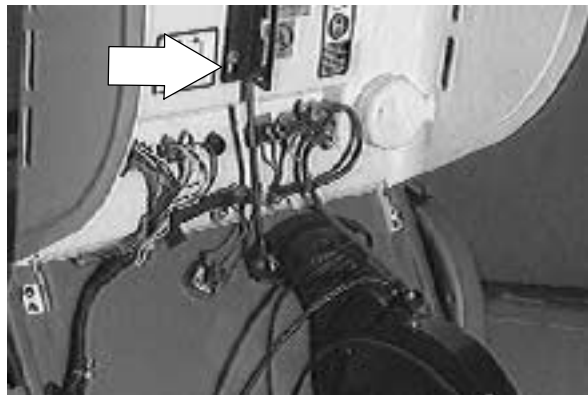

2. Turn the shut-off valve at the fuel tank to the closed position.

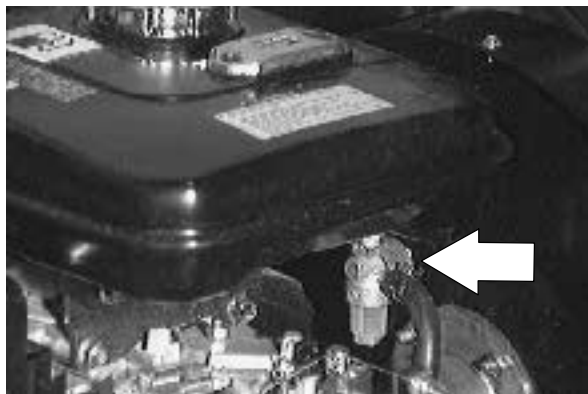

3. Start the engine and let it run until all of the gas is used in the fuel line and carburetor.

4. Remove the sediment bowl from the bottom of the fuel tank shut-off valve.





5. Clean any dirt or residue out of the sediment bowl.
6. Reinstall the sediment bowl on the fuel tank shut-off valve. Tighten firmly--but do not over tighten.

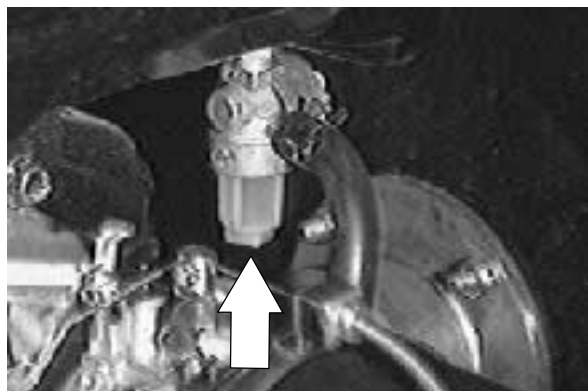

7. Turn the fuel tank shut-off valve to the open position.

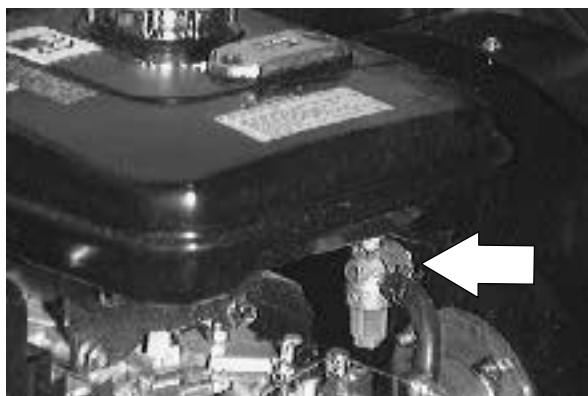

8. Start the engine and check the sediment valve for any leaks.

### **GAS CARBURETOR**

The gas carburetor is a horizontal draft, float type. Use an automobile grade of gasoline for best performance. This carburetor should not need to be adjusted. Remove, disassemble, and clean the carburetor every 500 to 600 hours.

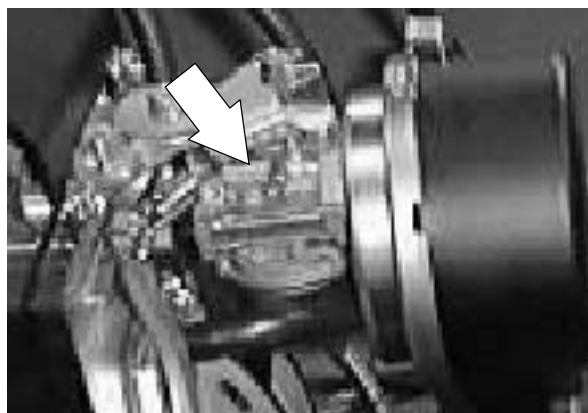

## FUEL SYSTEM - LPG

The model 3640 uses a liquid withdrawal type LP system. This system also includes an LP lock-off valve and a LP fuel vaporizer. The carburetor is similar to the one used on the gas machine except for a few internal modifications.

### LP FUEL TANK

The standard LP tank is a 20lb liquid withdrawal type.

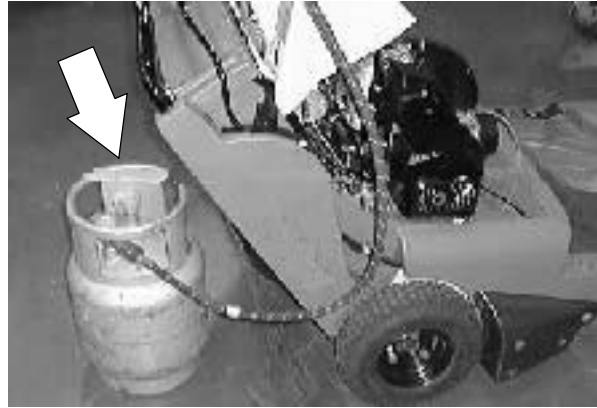

### TO CHANGE LPG FUEL TANK

**FOR SAFETY: Before Leaving Or Servicing Machine; Stop On Level Surface, Place Shifter In Park.**

1. Close the valve on the LP tank.
2. Run the engine until all of the LP gas has been used up in the fuel lines.

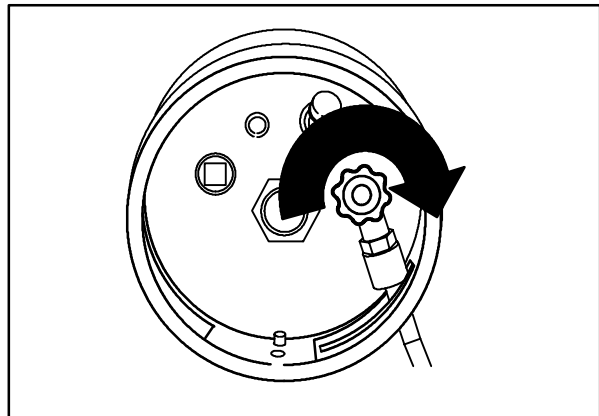

3. Disconnect the coupler at the tank outlet.

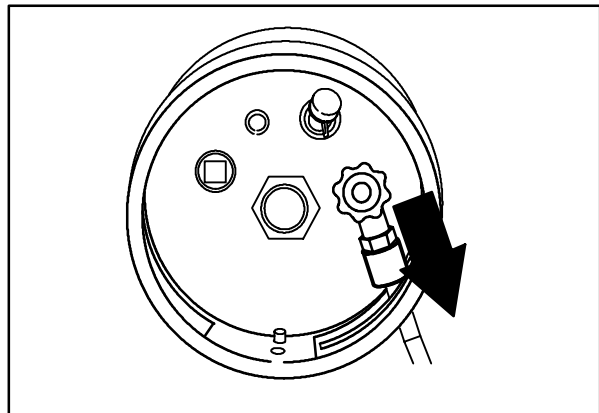

4. Lift up on the lock clamp on the tank strap.
5. Open the tank strap. Remove the LP tank from the machine.



6. Install a full LP tank with the connection on the liquid withdrawal valve.



7. Position the tank strap over the tank and snap the lock clamp.

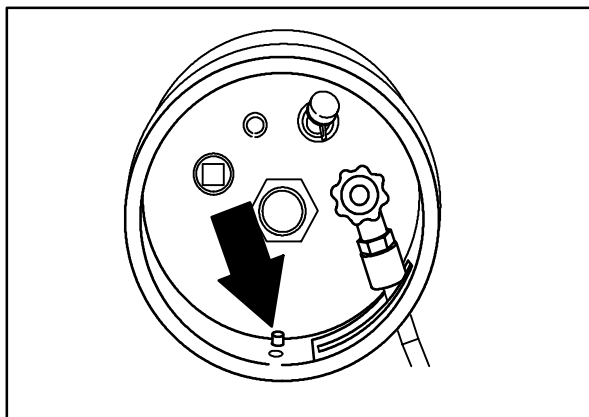

8. Re-connect the LP coupler on the tank valve. Turn on the valve.

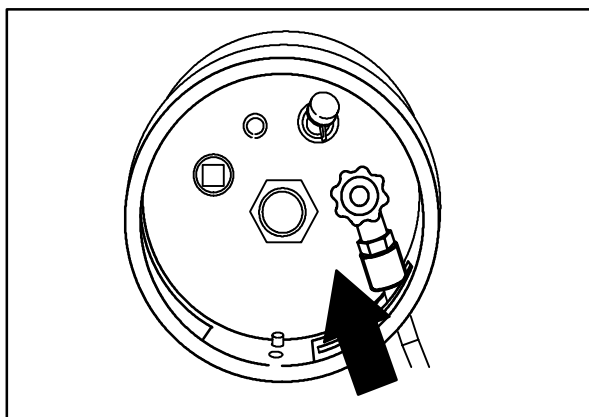

9. Start the engine and check the coupler for leaks.

## ENGINE-GAS/LP

### ENGINE CHOKE KNOB

An engine choke knob is standard equipment on all LP gas powered machines.

**On:** For cold starting, pull the engine choke knob out.

**Off:** Push the choke knob in.

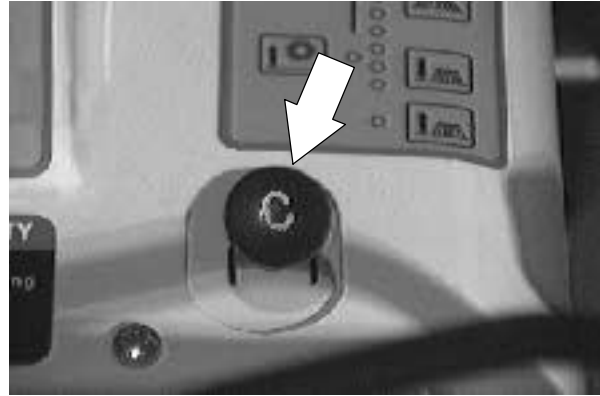

### LP CARBURETOR

The carburetor is similar to the one used on the gas machine except for a few internal modifications. A choke mechanism is also employed on this carburetor. It is recommended that the choke be pulled about half way closed for optimum starting. There are no external adjustments on the LP carburetor.

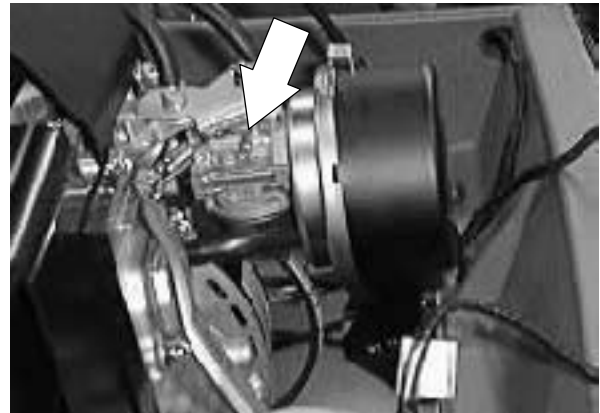

### LP LOCK-OFF/FILTER

The LP lock-off/filter is mounted on the back of the engine. The fuel line from the LP tank runs to the inlet port on the lock-off/filter. The outlet port on the lock-off is connected to the inlet port on the LP regulator. The lock-off/filter functions include removing impurities from the LP gas and stopping the flow of LP gas when the engine is not running.

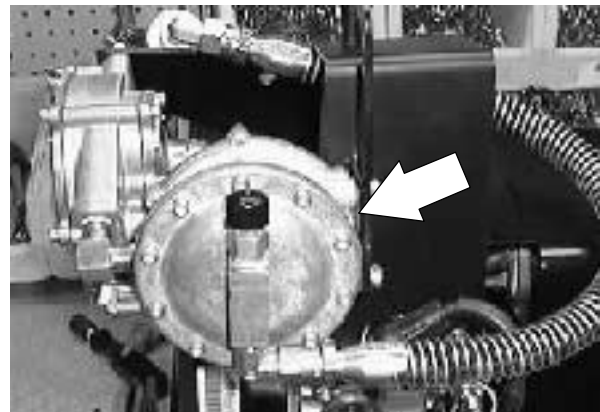

### LP REGULATOR

The LP regulator is mounted on the back of the engine. The inlet port on the regulator is connected to the outlet port of the lock-off/filter. The outlet port on the regulator is connected by hose to the LP carburetor. The LP regulator senses engine vacuum and controls the amount of LP fuel that flows to the carburetor. The LP regulator is non-adjustable.

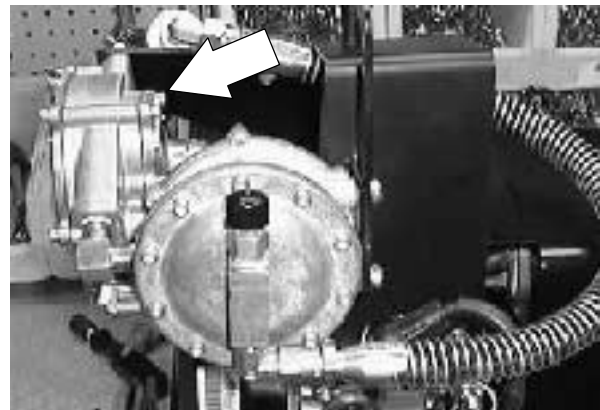

---

**IGNITION SYSTEM**

---

**SPARK PLUG**

Replace, or clean and set the gap of the spark plug after every 200 hours of use.

The proper spark plug gap is 0.75 mm (0.03 in).

**TO REPLACE SPARK PLUG**

**FOR SAFETY: Before Leaving Or Servicing Machine; Stop On Level Surface, Place Shifter In Park.**

1. Open the engine cover and engage the prop rod.

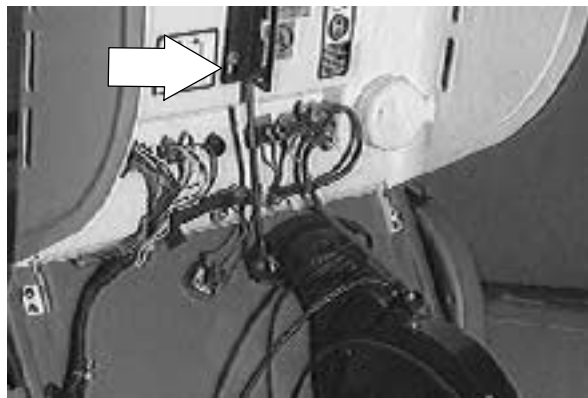

2. Remove the spark plug wire from the spark plug.
3. Use a spark plug wrench to loosen and remove the plug.
4. Clean any dirt from the area around the spark plug opening.
5. Install the new spark plug. Tighten firmly.
6. Reconnect the spark plug wire.
7. Close the engine cover and start the machine.
8. Clean or replace the spark plug every 50 hours. Replace with NGK B6HS.

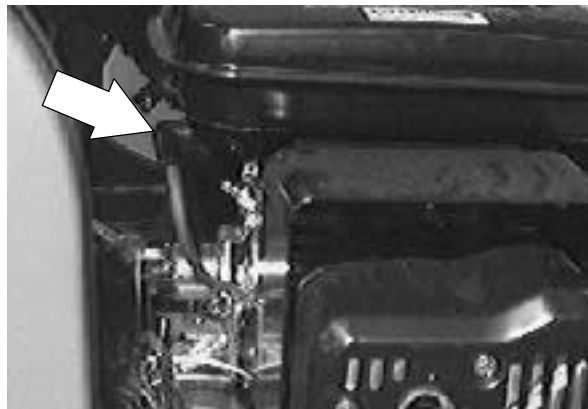

### ALTERNATOR

The engine on the model 3640 is not equipped with an external alternator. The alternator is located under the the engine flywheel. The alternator needs no regular maintenance.

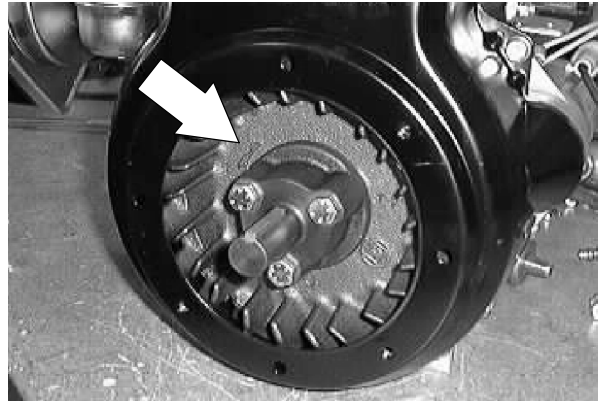

### LOW BATTERY CHARGE INDICATOR

The low battery charge indicator will illuminate when the battery charging system is not functioning properly. If the light remains on after the engine starts, contact TENNANT service personnel.



**TO REPLACE STARTER**

**FOR SAFETY: Before Leaving Or Servicing Machine; Stop On Level Surface, Place Shifter In Park.**

1. Open the engine cover and engage the prop rod.

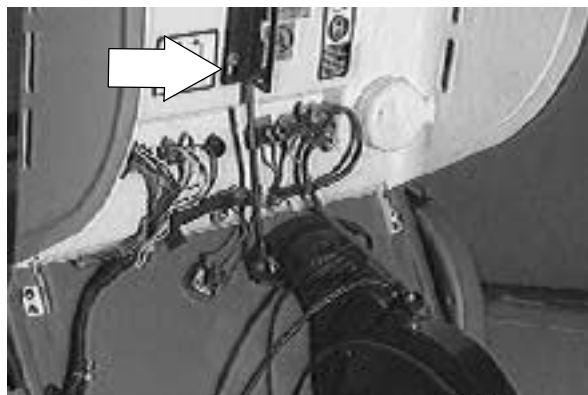

2. Disconnect the battery cables from the battery.

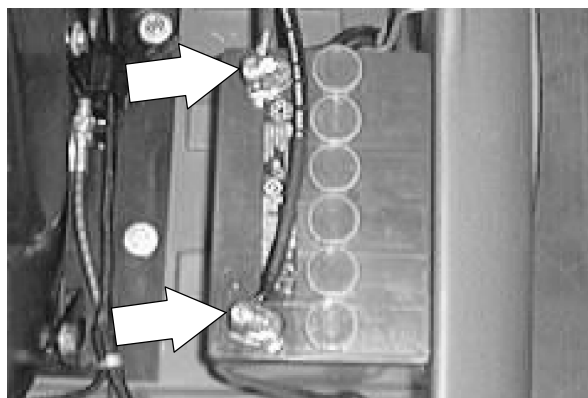

3. Disconnect the wire leading from the battery to the stud on the starter.

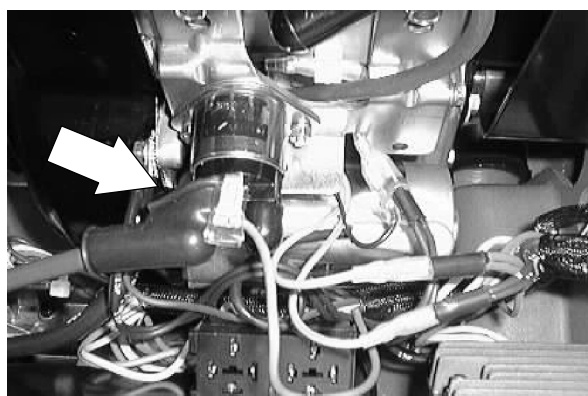

4. Remove the upper attachment bolt from the starter.



5. Go to the rear of the machine and locate the lower attachment bolt from the starter. Remove the bolt.

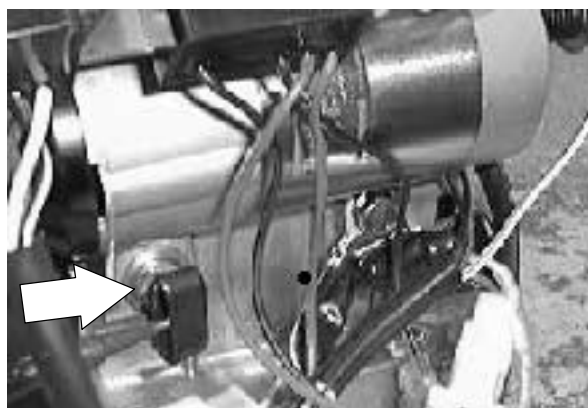

6. Remove the starter from the engine.

7. Position the new starter in the engine compartment. Line up the starter with the opening into the flywheel.

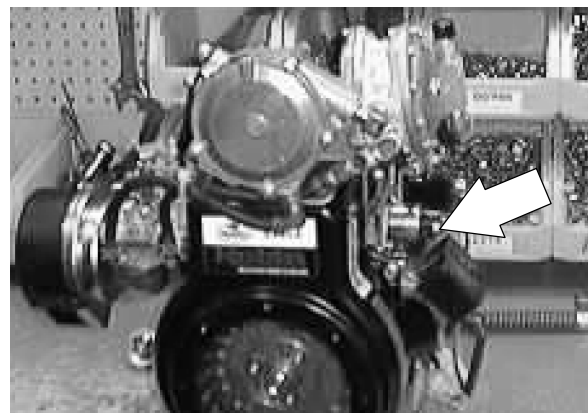

8. Reinstall the upper attachment bolt. Leave loose for now.

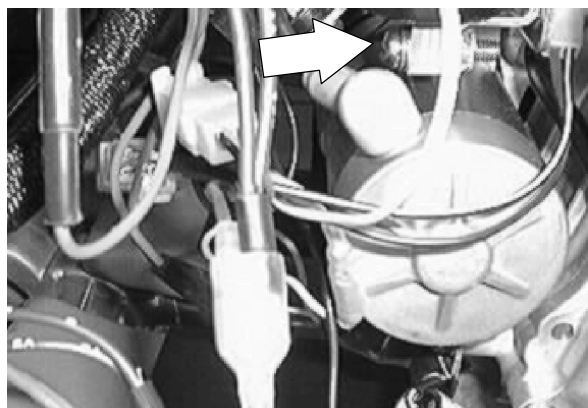



9. Reinstall the lower attachment bolt and tighten firmly. Go to the upper bolt and tighten firmly.

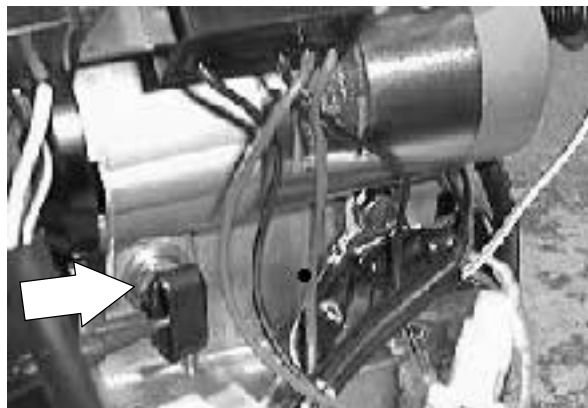

10. Reconnect the wire leading from the battery to the stud on the starter.

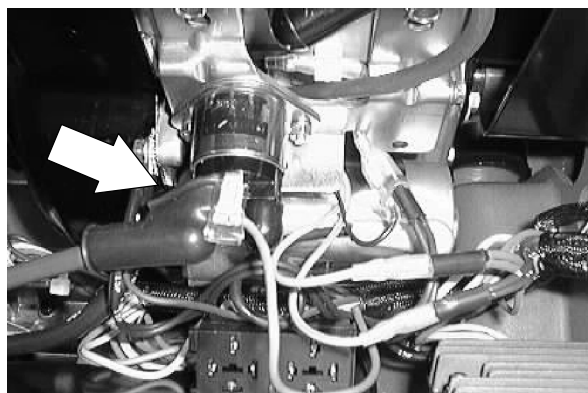

11. Reconnect the battery cables.

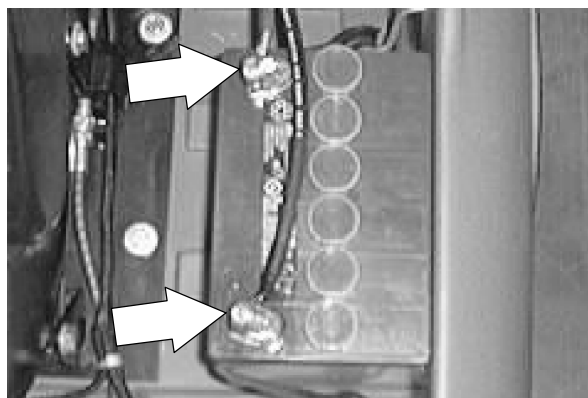

12. Start the engine. Check the new starter for proper operation.

### TO REMOVE ENGINE

**FOR SAFETY: Before Leaving Or Servicing Machine; Stop On Level Surface, Place Shifter In Park.**

1. Open the engine cover and engage the prop rod.

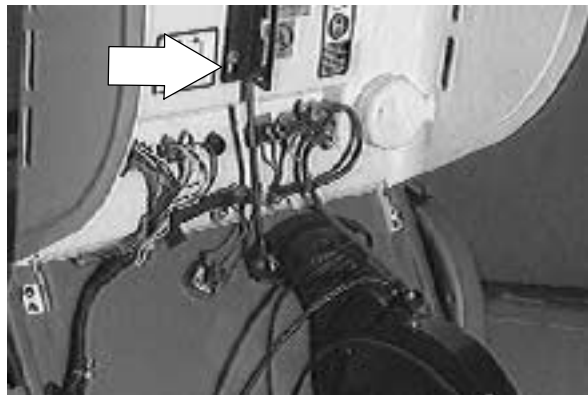

2. Disconnect the battery cables.

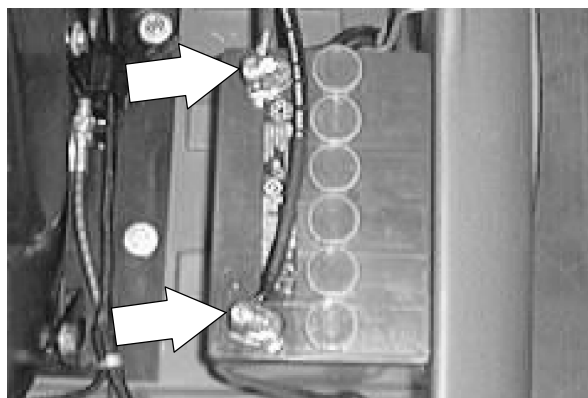

3. **LP MACHINE:** Remove the LP tank and mounting brackets.

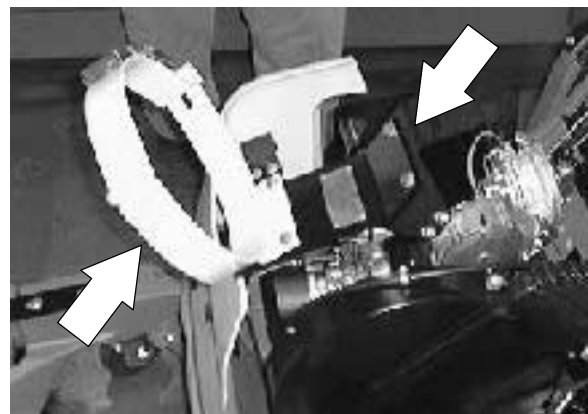

4. Remove the engine cover from the machine.

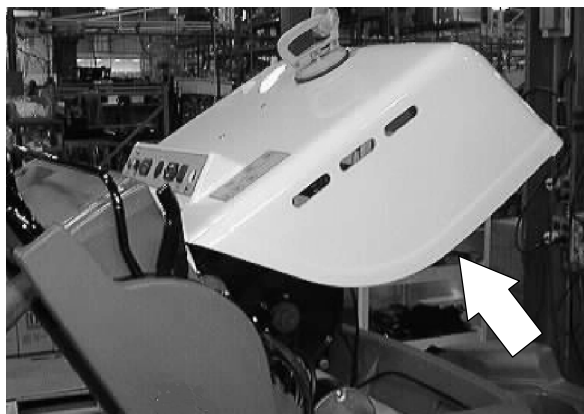

5. Disconnect the choke cable at the carburetor.



6. Remove the flat drive belt from the engine sheave.



7. Loosen the vacuum fan belt and remove it from the engine sheave.

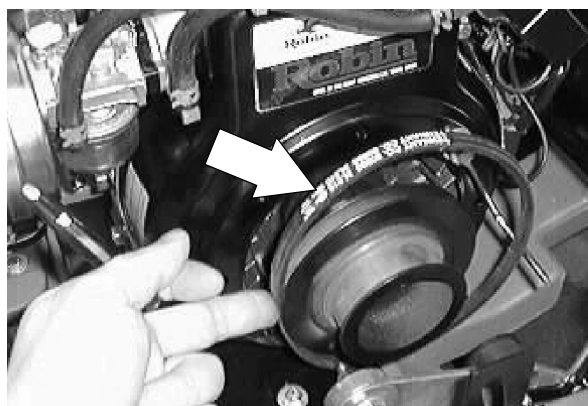

## ENGINE-GAS/LP

8. Remove the right side drive wheel assembly.  
See TO REMOVE REAR TIRE instructions in the CHASSIS section.

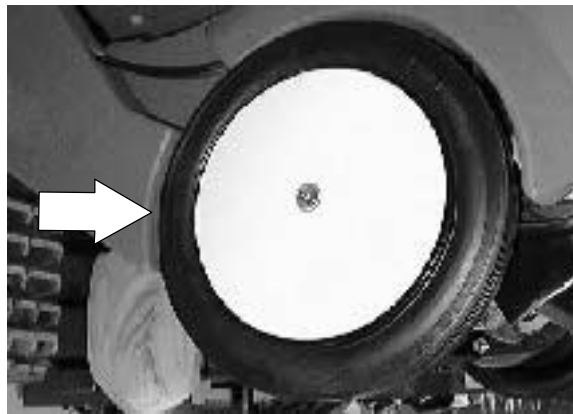

9. Remove the tension on the main brush drive belt and slip it off the engine drive sheave.

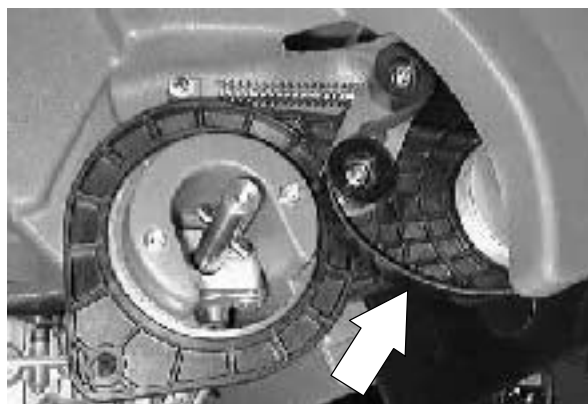

10. Disconnect two alternator wires, two low oil pressure switch wires, one solenoid wire, one ground cable, and a positive battery cable from the back of the engine.

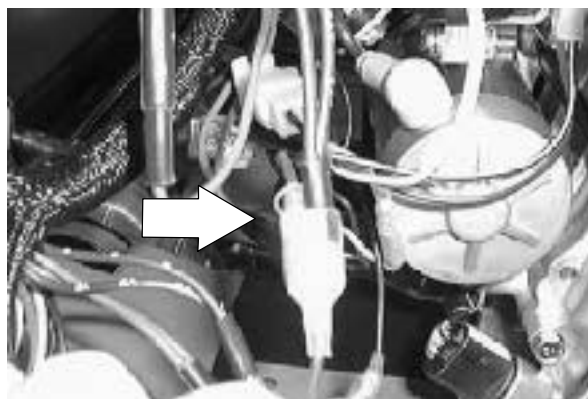

11. Remove the main brush from the machine.  
See TO REPLACE MAIN BRUSH instructions in the SWEEPING section.



12. Remove the two front engine mount bolts. Access this hardware by going into the brush wrap area and locating the two hardware dimples in the roof of the frame.

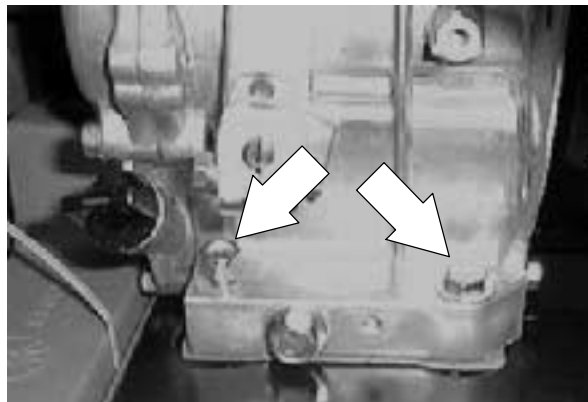

13. Remove the two rear engine mount bolts. Access this hardware by going to the rear of the machine and locating the two hardware dimples in front of the brush arm mount bracket and above the transaxle.

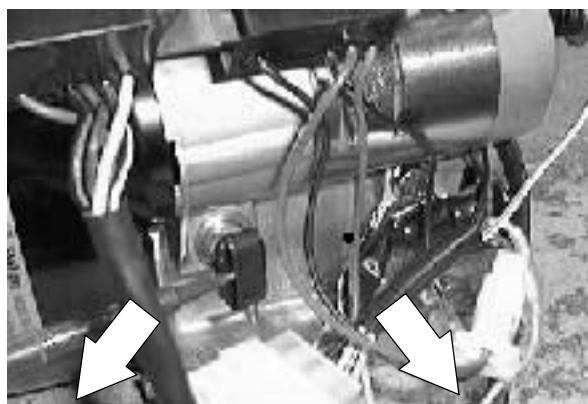

14. The engine can now be removed from the machine.

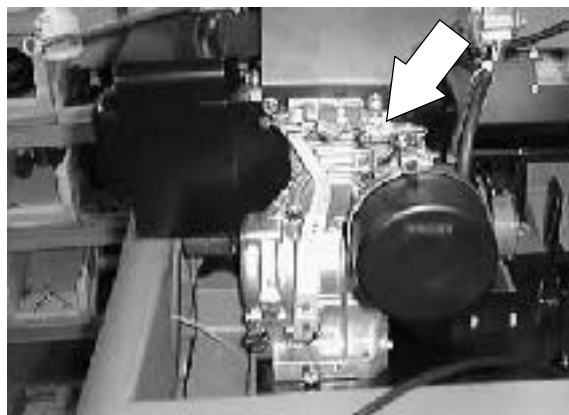

15. Remove the drive sheaves from both sides of the old engine and install them on the new engine in the same orientation.

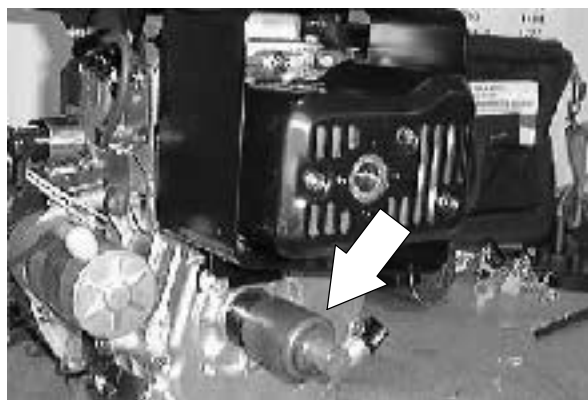

### TO INSTALL ENGINE

**FOR SAFETY: Before Leaving Or Servicing Machine; Stop On Level Surface, Place Shifter In Park.**

1. Position the engine on the mount plate.
2. Line up the four mount holes on the engine block with the mount holes in the machine frame.

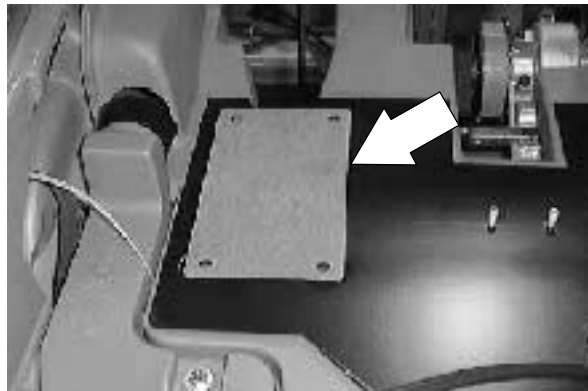

3. Install the two front engine mount bolts. Access this hardware by going into the brush wrap area and locating the two hardware dimples in the roof of the frame.

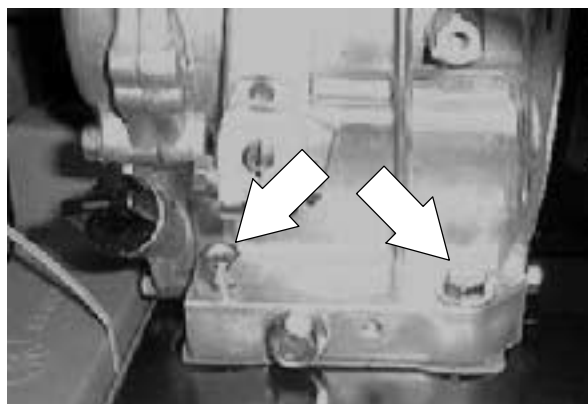

4. Install the two rear engine mount bolts. Access this hardware by going to the rear of the machine and locating the two hardware dimples in front of the brush arm mount bracket and above the transaxle.

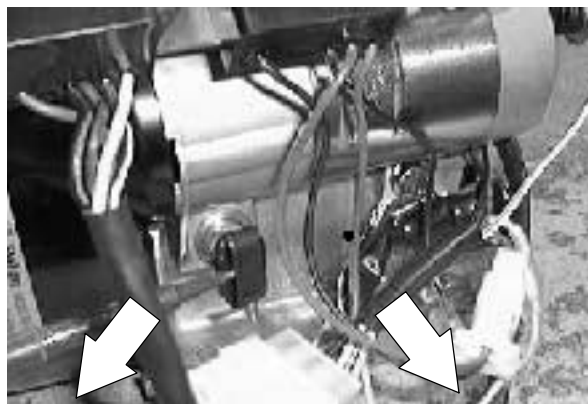

5. Install the main brush in the machine. See TO REPLACE MAIN BRUSH instructions in the SWEEPING section.

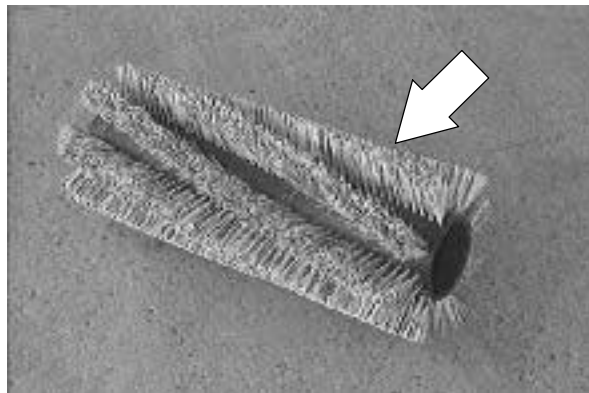

6. Reconnect the two alternator wires, two low oil pressure switch wires, one solenoid wire, one ground cable, and a positive battery cable one the back of the engine. See schematic in the ELECTRICAL section.

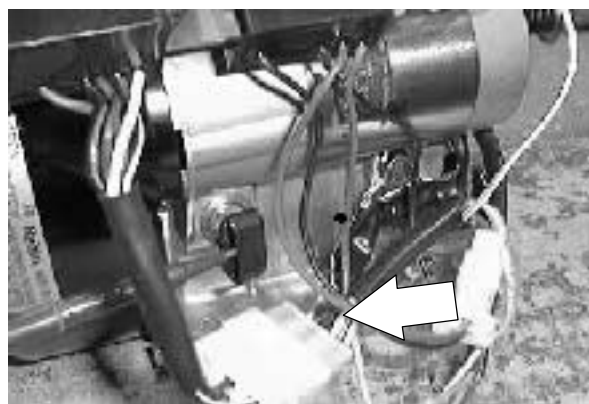

7. Install the main brush drive belt over the sheave on the right side of the engine. See TO REPLACE MAIN BRUSH DRIVE BELT instructions in the SWEEPING section.



8. Reinstall the right side drive wheel assembly. See TO INSTALL REAR TIRE instructions in the CHASSIS section.



## ENGINE-GAS/LP

9. Install the vacuum fan V-belt over the sheave on the left side of the engine. See TO TENSION VACUUM FAN V-BELT instructions in the SWEEPING section.

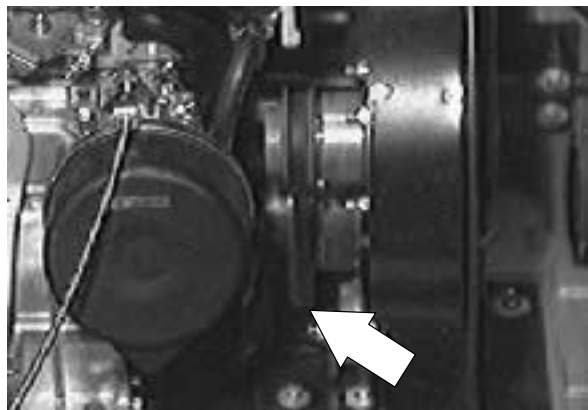

10. Reinstall the flat transaxle drive belt over the sheave on the left side of the engine. See TO REPLACE FLAT DRIVE BELT instructions in the CHASSIS section.

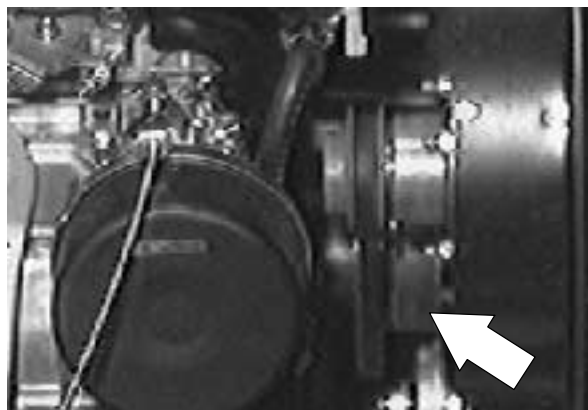

11. Reconnect the choke cable at the carburetor.

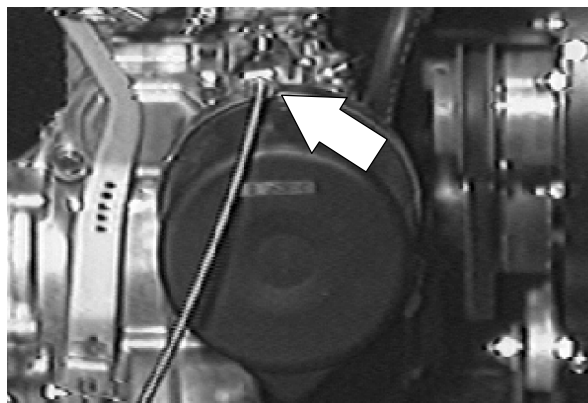

12. **LP MACHINE:** Install the LP tank mounting brackets and LP tank. Reconnect the LP hose to the tank. Open the valve.

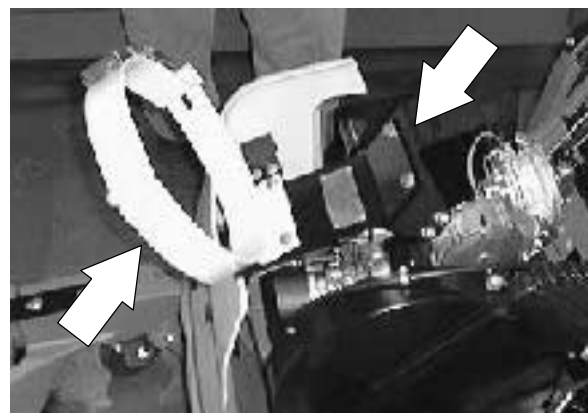



13. Reconnect the battery cables to the battery.

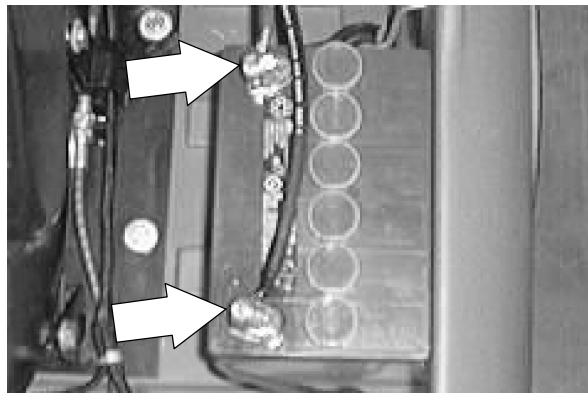

14. Reinstall the engine cover.

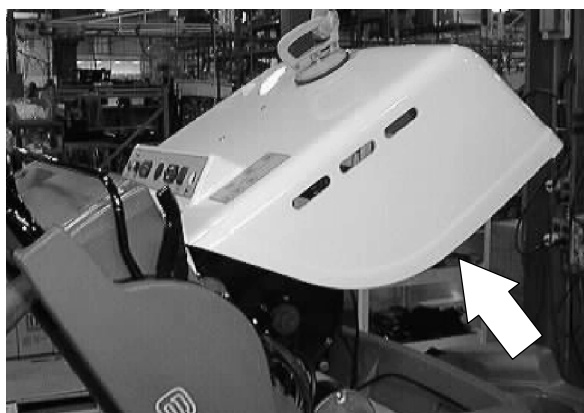

15. Check the engine for oil. If needed, fill the engine with oil. The capacity of this engine is 0.65 liters (0.17 U. S. gallon). Use an automobile grade SAE #20, #30, or 10W-30

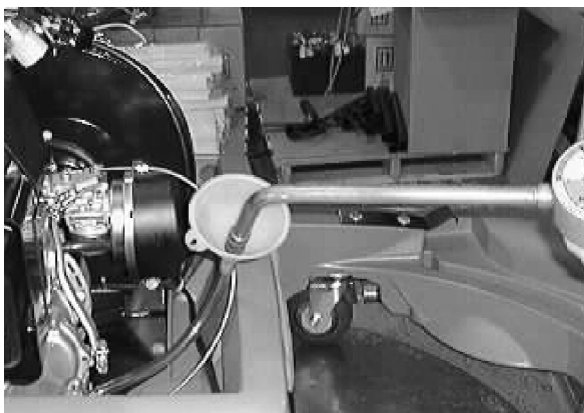

16. Start the engine and check for proper operation.







**TENNANT COMPANY**  
 Technical Publications #15  
 701 North Lilac Drive  
 P.O. Box 1452  
 Minneapolis, MN 55440-9947

POSTAGE WILL BE PAID BY ADDRESSEE

**BUSINESS REPLY MAIL**  
 FIRST CLASS MAIL PERMIT NO. 94 MINNEAPOLIS, MN



NO POSTAGE  
 NECESSARY  
 IF MAILED  
 IN THE  
 UNITED STATES

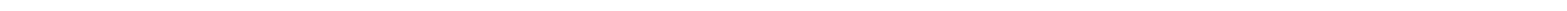

Fold along dotted lines

Tape here

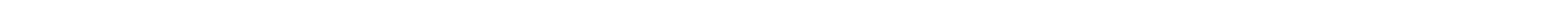





**TENNANT COMPANY**  
 Technical Publications #15  
 701 North Lilac Drive  
 P.O. Box 1452  
 Minneapolis, MN 55440-9947

POSTAGE WILL BE PAID BY ADDRESSEE

**BUSINESS REPLY MAIL**  
 FIRST CLASS MAIL PERMIT NO. 94 MINNEAPOLIS, MN



NO POSTAGE  
 NECESSARY  
 IF MAILED  
 IN THE  
 UNITED STATES



Fold along dotted lines

Tape here

