

TOMCAT®

SPORT

Operating Instructions (EN)

MODELS:

17" Disk

20" Disk

25" Cylindrical

20" EDGE

24" EDGE

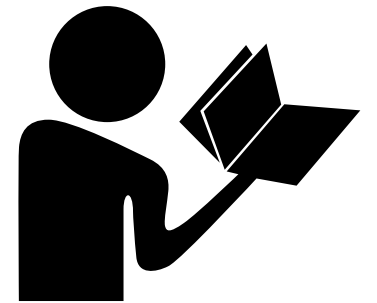
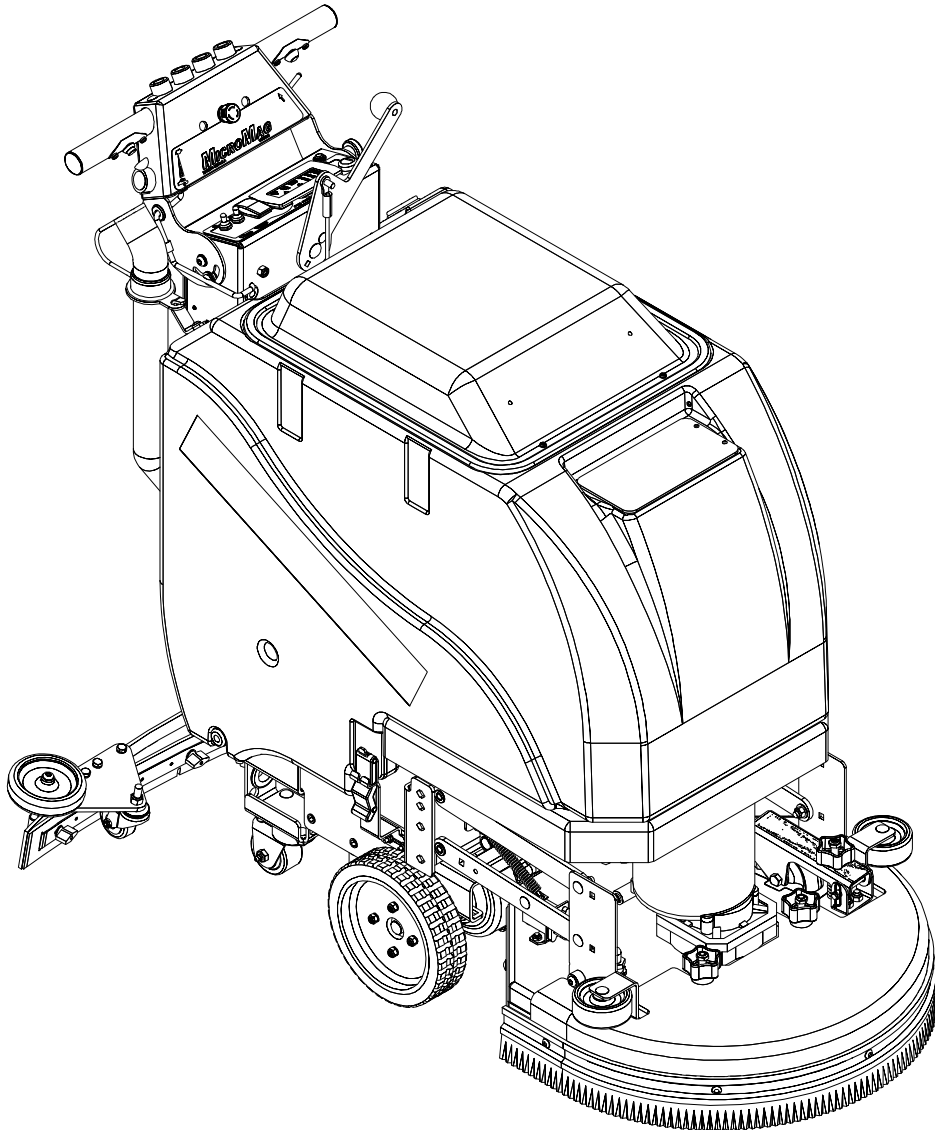

Read these Instructions before using the machine.



Read these Safety Messages before using the machine.

www.tomcatequip.com
1711 South Street
Racine, WI 53404 (USA)
(800) 450-9824 | (+001) 262-681-6470
© 2016 RPS Corporation

Scan With Phone for more Information



VERSION 16.224
TC-SPORT-OP-EN

INTRODUCTION

This manual is furnished with each new machine. This manual will allow the Operator to get the best performance out of your RPS manufactured Scrubber-Drier, Sweeper, Burnisher, or Orbital Scrubber. Read this manual thoroughly before operating or servicing the machine.

This machine will provide excellent performance, but the best results will be obtained at the most minimum costs if:

- The machine is regularly maintained - per the Authorized Local Distributor.
- The machine is operated with reasonable care and caution.
- The machine is maintained with manufacturer supplied parts.

LOCATE SERIAL NUMBER

The serial number of your machine is located on the lower half of the control panel of the machine.



AS OUR POLICY IS ONE OF CONSTANT IMPROVEMENT - ALL INFORMATION AND SPECIFICATIONS ARE SUBJECT TO CHANGE WITHOUT NOTICE.

TABLE OF CONTENTS



	Introduction.....	2
	Locate Serial Number.....	2
	Table Of Contents.....	3
	Safety Messages.....	4
	Safety Labels.....	6
	LCD Screen.....	7
	Operation Controls.....	8
	Battery Setup.....	9
	Remove Squeegee.....	10
	Adjust Squeegee.....	11
	Remove From Battery Charger.....	12
	Transportation - Forward.....	13
	Transportation - Reverse.....	14
	Fill Solution Tank.....	15
	Operation - Scrubbing.....	16
	Draining Recovery Tank.....	17
	Draining Solution Tank.....	18
	Flushing Recovery Tank.....	19
	Clean Drain Saver.....	20
	Clean Cylindrical Hopper.....	21
	Clean Vac Box System.....	22
	Remove Disk Brushes.....	23
	Remove Cylindrical Brushes.....	24
	Remove EDGE Pads.....	25
	Charge Batteries.....	26
	Battery Chargers.....	27
	Common Wear Parts.....	28
	Round Disk Brushes:.....	28
	Round Disk Pads:.....	28
	Cylindrical Brushes:.....	28
	EDGE Pads and Screens:.....	28
	EDGE Grip Face:.....	29
	Squeegee Blade Kits & Complete Squeegee Assemblies:.....	29



SAFETY MESSAGES

You will see four kinds of safety reminders in this manual:

DANGER

DANGER indicates a hazardous situation which, if not avoided, will result in death or serious injury.

CAUTION

CAUTION indicates a potentially hazardous situation which, if not avoided, could result in minor or moderate injury or damage to this machine or nearby objects. CAUTION also can be used to alert against unsafe practices.

WARNING

WARNING indicates a potentially hazardous situation which, if not avoided, could result in death or serious injury.

NOTICE

NOTICE indicates information considered important, but not hazard-related. This safety message may be related to property damage or warranty warnings.

Your safety, and that of others, is very important. Operating this machine safely is an important responsibility.

DO NOT OPERATE THIS MACHINE:

- Unless you are trained and authorized to do so by your RPS Authorized Local Distributor
- Unless you have read and understood this Operator's Manual
- On surfaces with greater than a 2% grade unless this machine is equipped with a functional parking brake
- On surfaces with greater than an 8% grade at any time
- On Loading Docks

WHEN OPERATING THIS MACHINE:

- Remove loose objects from the floor that could be projected from the rotating Brushes
- Keep your hands and feet away from the rotating Brushes
- Do not operate this machine where flammable liquids, vapors, or dust are present
- Use caution when maneuvering

BEFORE LEAVING THE MACHINE:

- Drain "clean" Solution & "dirty" Recovery solution into APPROVED drains
- Park the machine on a level surface
- Turn the machine off & remove key

BEFORE SERVICING THE MACHINE:

- Disconnect the Batteries

DANGER

Explosive hydrogen gas forms when Batteries are charging. An open flame or spark can cause this gas to explode. Serious personal injury or property damage could occur. Only charge the Batteries in this machine in a well ventilated area.

DANGER

Flammable materials can cause an explosion or fire. Do not use flammable materials in Tank or pick up.

⚠ WARNING

The Batteries in this machine produce hazardous voltage which can cause electrical shock, burns and/or electrocution. Always disconnect Batteries before servicing this machine.

⚠ WARNING

When climbing or descending ramps, always drive machine forward. To avoid overturning the machine, Do not back down ramps. Do not drive across inclines. Do not turn while ascending or descending ramps. Overturning the machine can cause serious injury or death.

⚠ WARNING

Do not use water that exceeds 135°F / 57°C. If water is above said temperature, this will void the Tank Warranty.

⚠ WARNING

Do not park this machine on ramps or slopes. Always park this machine on a level, hard surface. Do not operate this machine outdoors or on uneven surfaces.

⚠ WARNING

The Batteries in this machine contain sulfuric acid, which causes burns to skin. If battery acid contacts clothing or skin, rinse the effected area with cold water immediately. If battery acid gets on your face or in your eyes, flush the area immediately with cold water and seek medical attention.

⚠ WARNING

To avoid electrical shock, do not operate this machine over electrical floor outlets.

⚠ CAUTION

To avoid damage to this machine, use only cleaning solutions and replacement parts recommended by the manufacturer.

⚠ CAUTION

Do not operate this machine if any parts have been damaged or removed.

⚠ WARNING

Dress safely. Do not wear rings or metal wrist watches when servicing this machine, as they can cause an electrical short circuit which can cause serious burns.

⚠ WARNING

Do not remove, paint over or destroy warning decals. If warning decals become damaged, call 1-262-681-3583 for free replacements.

⚠ WARNING

Dress safely. Do not wear a neck tie, scarf, or any loose or dangling clothing while operating this machine. Loose or dangling clothing or neck-wear can tangle in rotating parts, causing serious injury or death.

⚠ WARNING

Always turn off this machine before leaving it unattended. Do not allow untrained persons to operate this machine.

⚠ WARNING

NO RIDERS. Do not carry passengers on this machine. Do not use this machine as a stepladder or work platform.

⚠ WARNING

Understand the dynamic braking system before you operate the machine on ramps. Machine may coast.

⚠ WARNING

Before you service a Battery, always wear face protection, protective gloves and protective clothing. Battery acid or battery explosion can cause serious injuries.

⚠ CAUTION

Always use the automatic battery charger provided by the manufacturer of this machine to charge the Batteries of this machine. It is designed to charge the Batteries at the appropriate rate. If you must use a different charger, disconnect the Batteries before charging to avoid damage to the electronic speed controller.

⚠ CAUTION

To avoid damage to the electronic control components of this machine, Do not store this machine outdoors. Do not pressure wash this machine.



SAFETY LABELS

Read and obey all Safety Labels on your SPORT Floor Scrubber. If you have questions about these labels, ask your supervisor.

These images indicate where on the SPORT Safety Labels are located. If ever the labels become illegible, worn off, or torn, promptly report it to your supervisor and replace it.

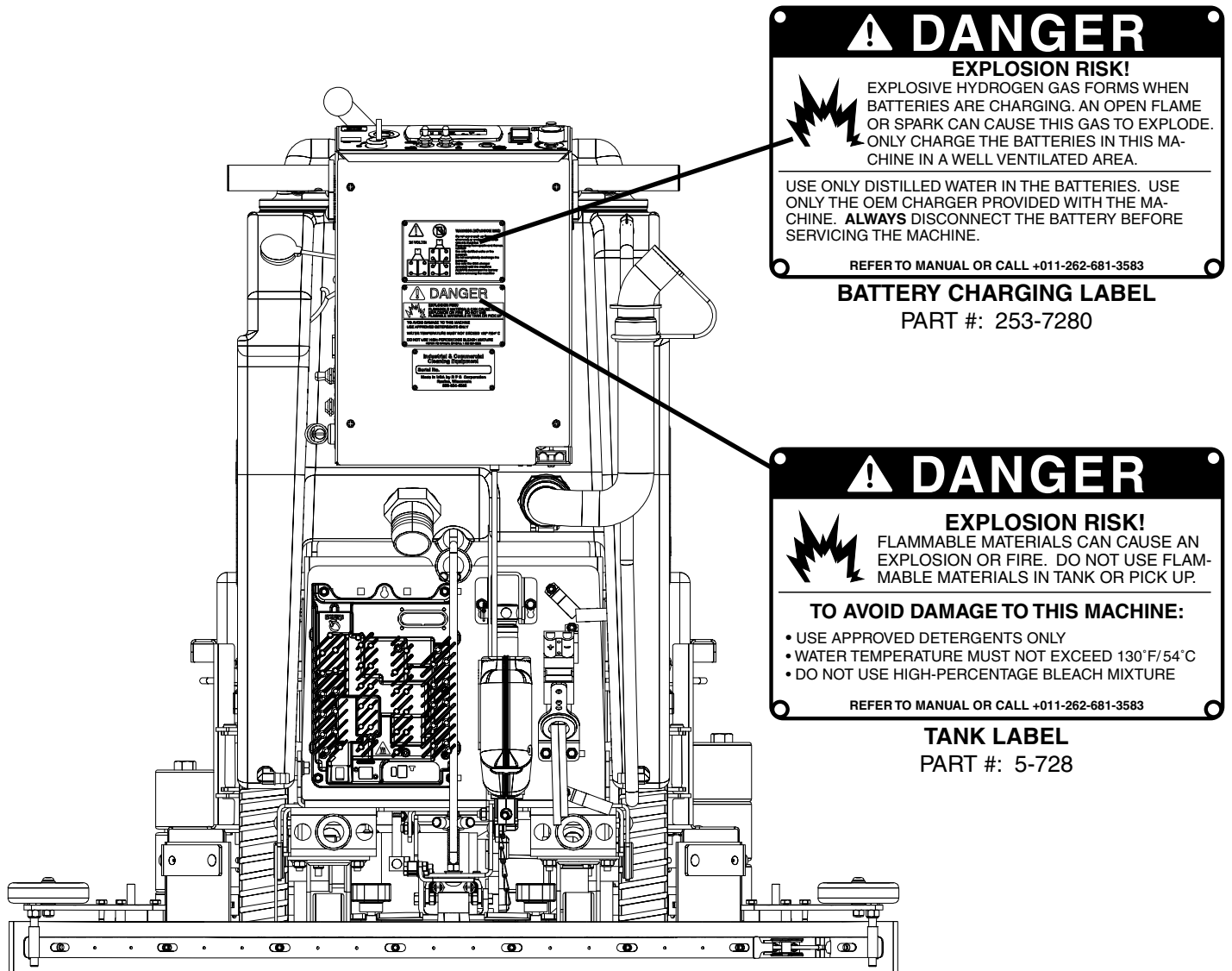

LCD SCREEN



SCREEN #1 (OPERATOR)

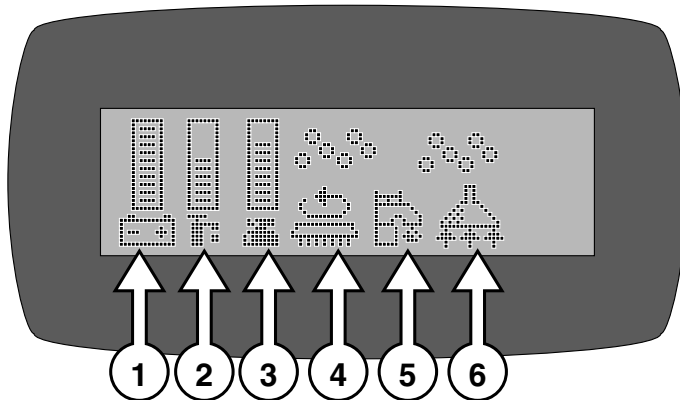

SCREEN #2 (MAINTENANCE)

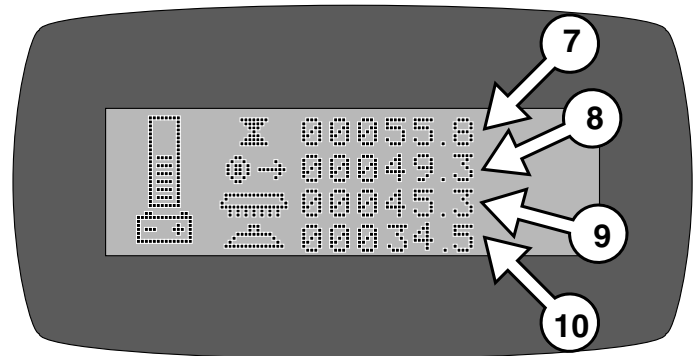

SCREEN #3 (WITH ERROR CODE)

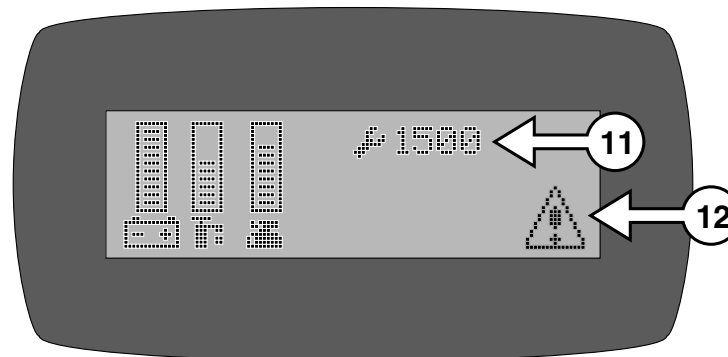

**** USE GREEN MENU SELECTION BUTTON ON CONTROL PANEL TO CHANGE SCREENS ****

1. **BATTERY LEVEL INDICATOR** - Indicates the energy level remaining in the Batteries (*Shown on all menu displays*)
2. **SOLUTION OUTPUT INDICATOR** - Indicates the gallons per minute (*GPM*) 0 - 1.0
3. **SCRUBDECK DOWN PRESSURE INDICATOR** - Sets the down pressure on the Brushes / Pads
4. **SCRUB MOTORS ON** - Indicates the Brush Motors are in operation
5. **SOLUTION ON** - Indicates the solution flow is *ON*
6. **VACUUM ON** - Indicates the Vacuum is *ON*
7. **KEY SWITCH HOUR METER** - Indicates total hours the machine has had keyswitch *ON*
8. **TRANSPORT HOUR METER** - Indicates total hours the drive system has been in operation
9. **SCRUB BRUSH HOUR METER** - Indicates total hours the brush motors have been in operation
10. **VACUUM HOUR METER** - Indicates total hours the vacuum motor has been used
11. **DIAGNOSTIC CODE** - Displays diagnostic code which helps troubleshoot issues
12. **ERROR WARNING SYMBOL** - Indicates when there has been a diagnostic code error



OPERATION CONTROLS

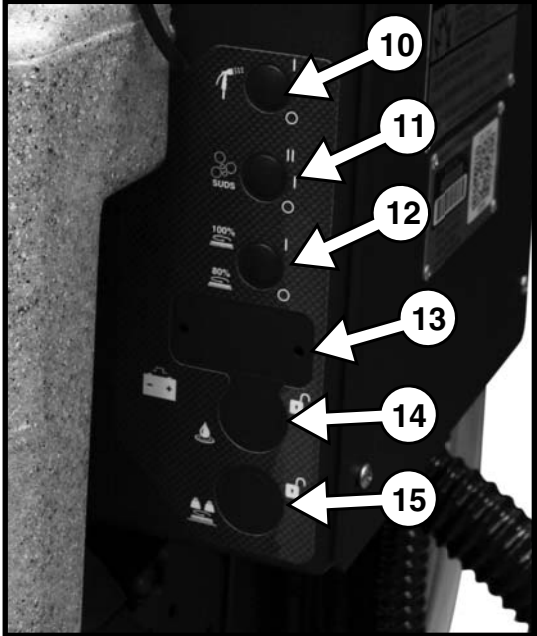
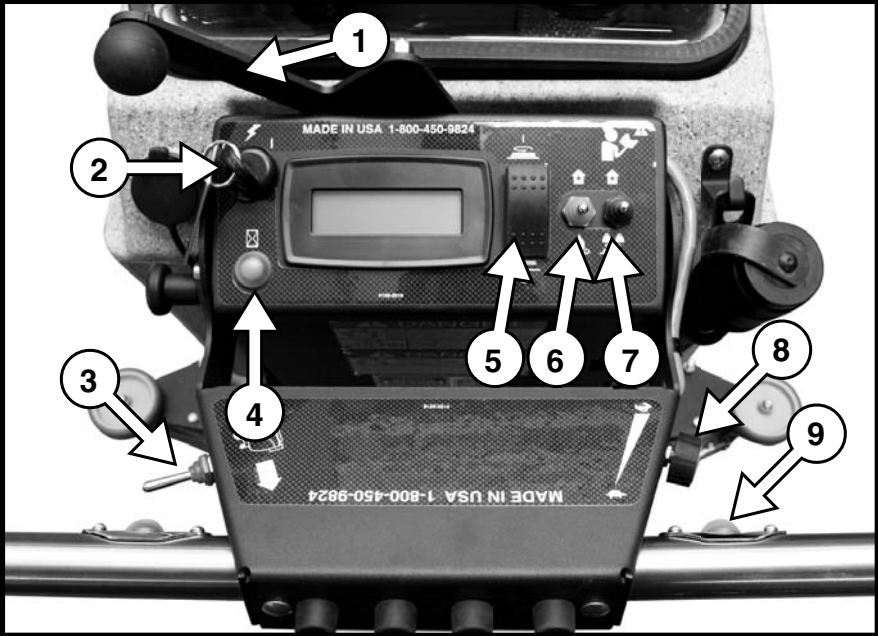

<p>1.</p>	<p>2.</p>	<p>3.</p>
<p>4.</p>	<p>5.</p>	<p>6.</p>
<p>7.</p>	<p>8.</p>	<p>9.</p>
<p>10.</p>	<p>11.</p>	<p>12.</p>
<p>13.</p>	<p>14.</p>	<p>15.</p>

BATTERY SETUP

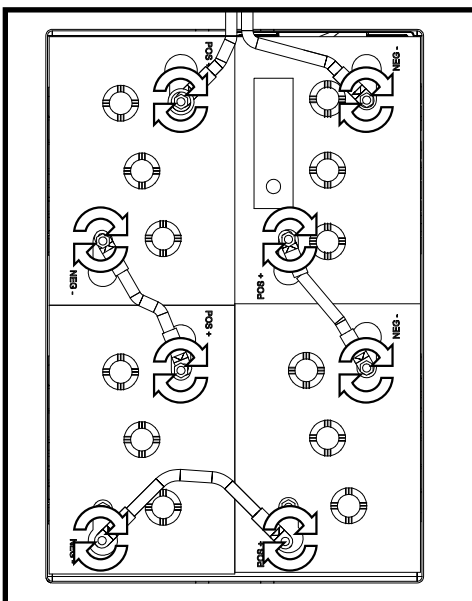
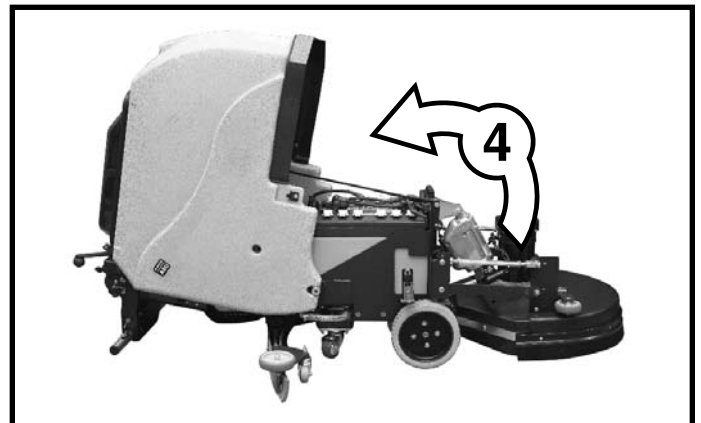
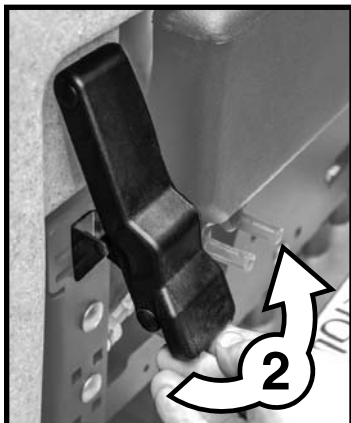
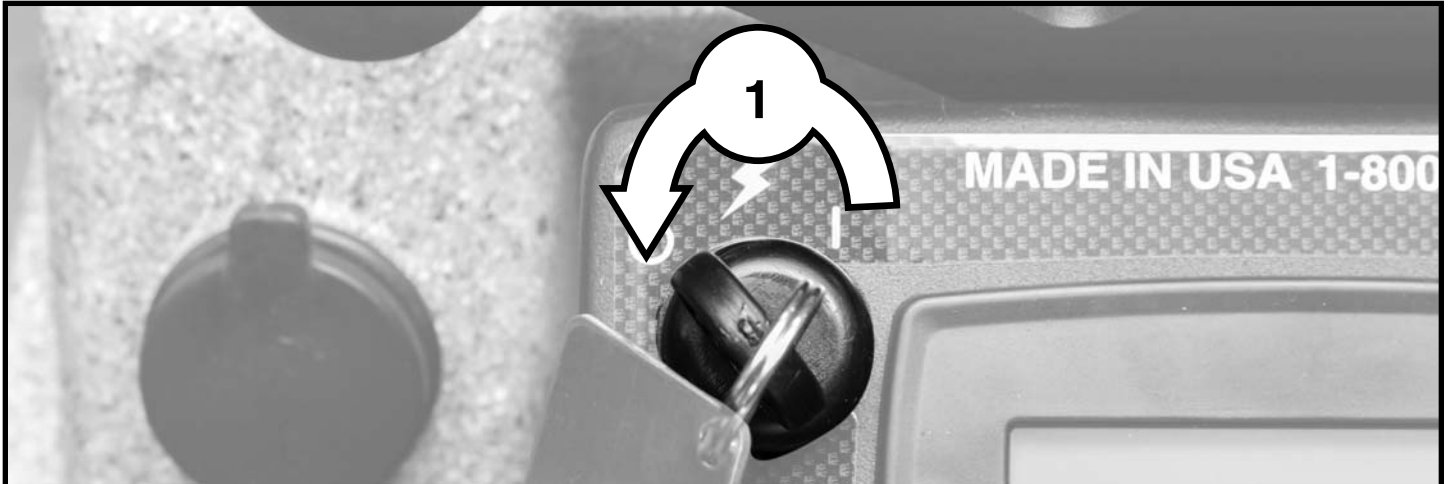
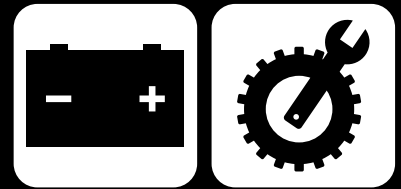

24 VOLTS

NOTICE

Batteries are a possible environmental hazard. Consult your Battery supplier for safe disposal methods.

NOTICE

Orientation of Batteries is critical for cables to reach. Ensure proper torque values when installing batteries. (Between 8 - 12 ft/lbs)



REMOVE SQUEEGEE

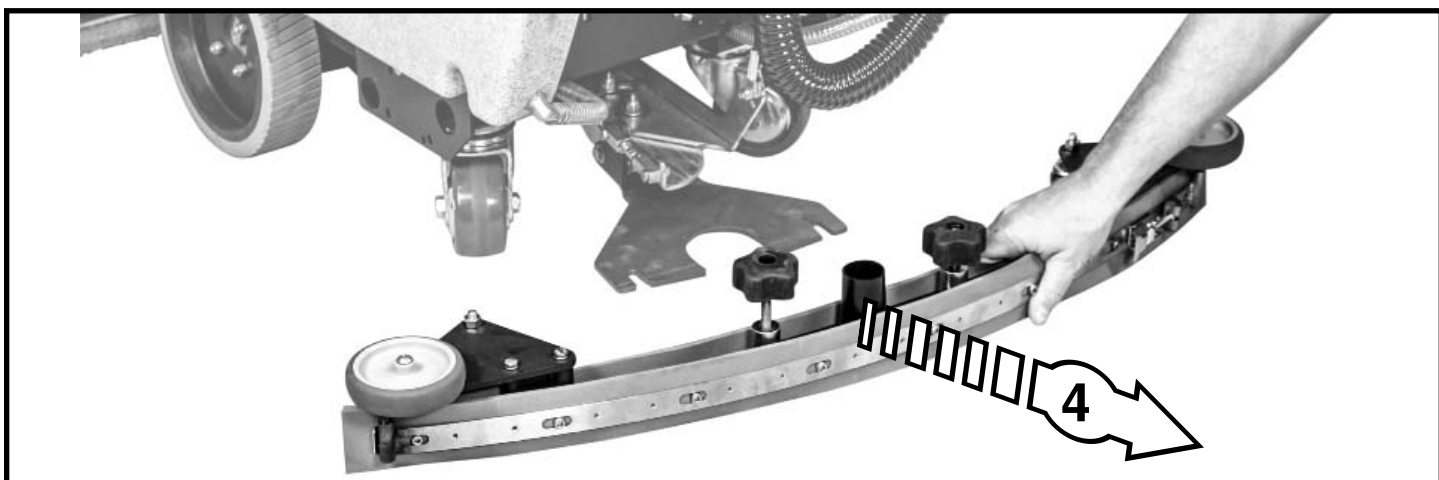
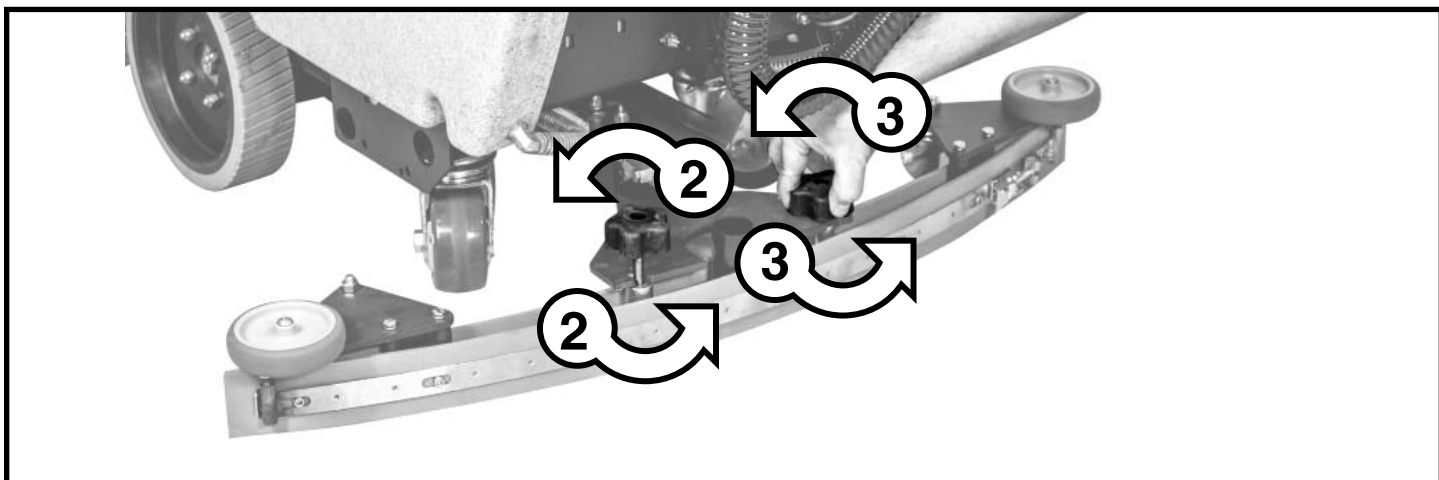
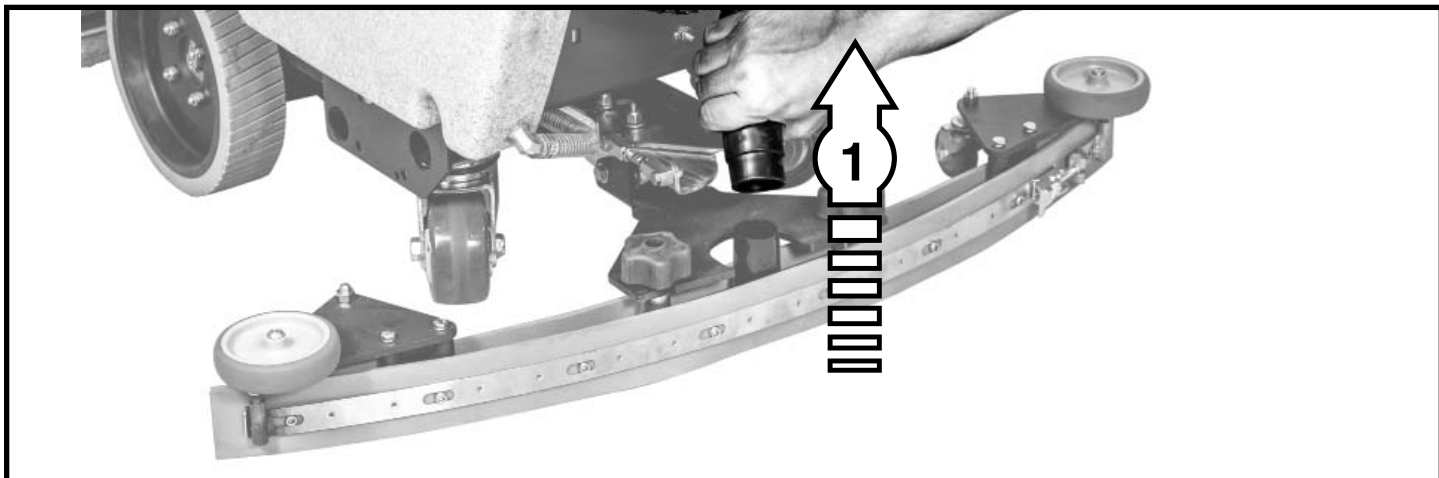

ADJUST SQUEEGEE

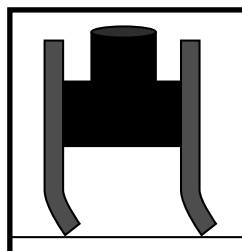
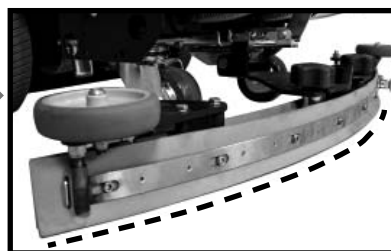
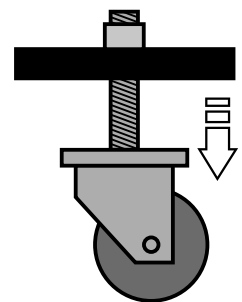
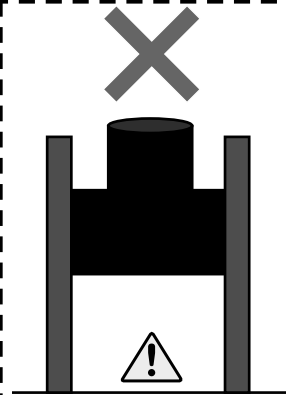
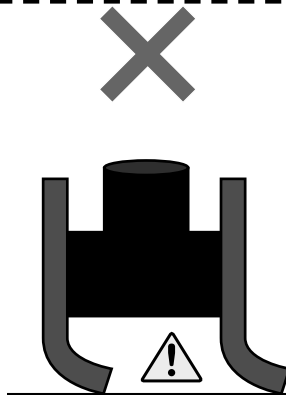
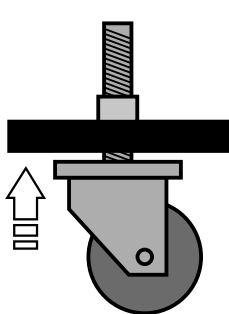
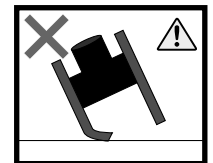
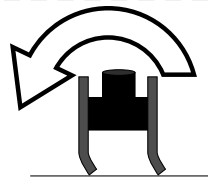
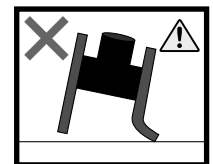
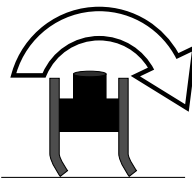
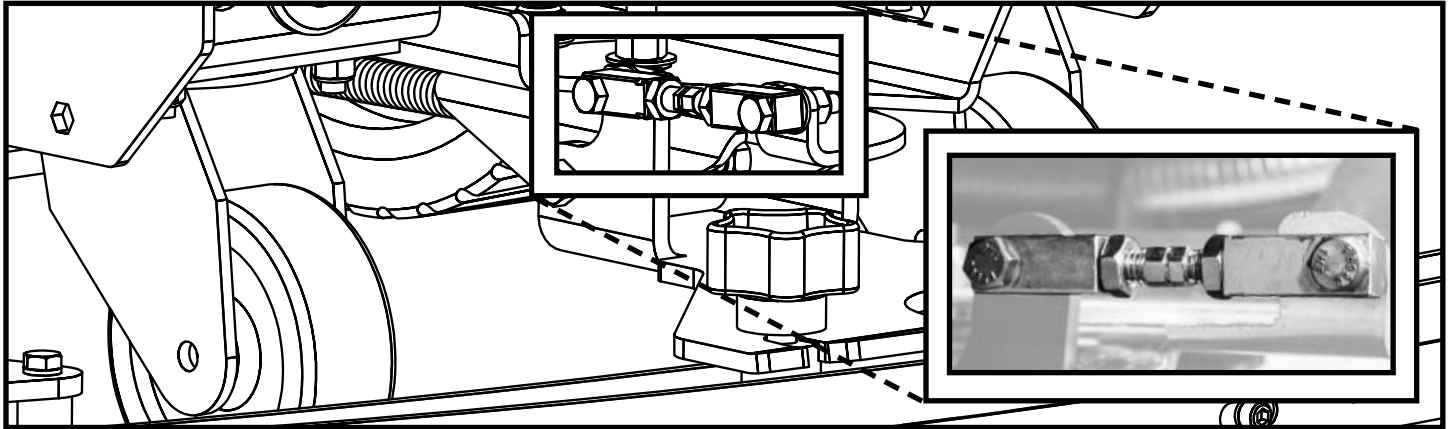
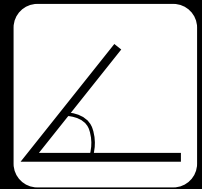
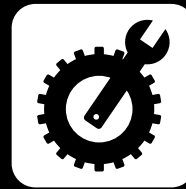

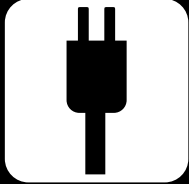
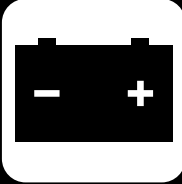

REMOVE FROM BATTERY CHARGER

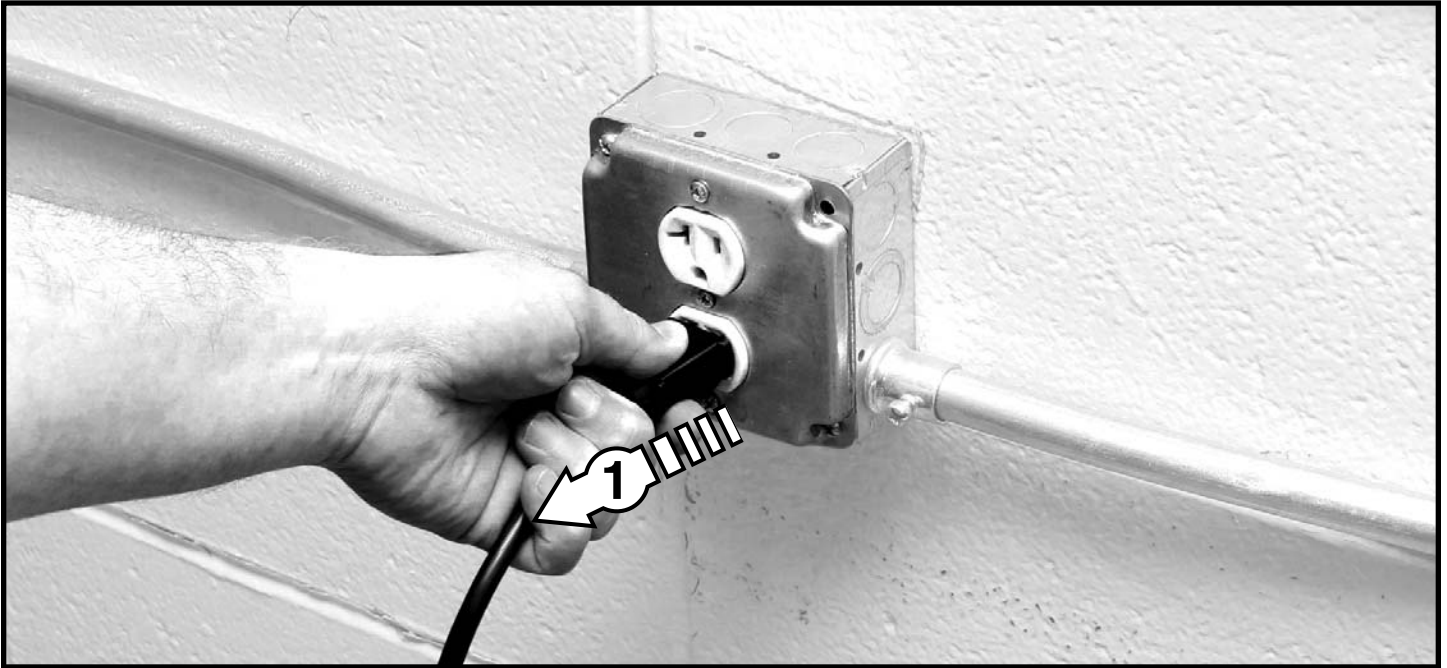

Please refer to OEM Charger Operating Instructions for more information.

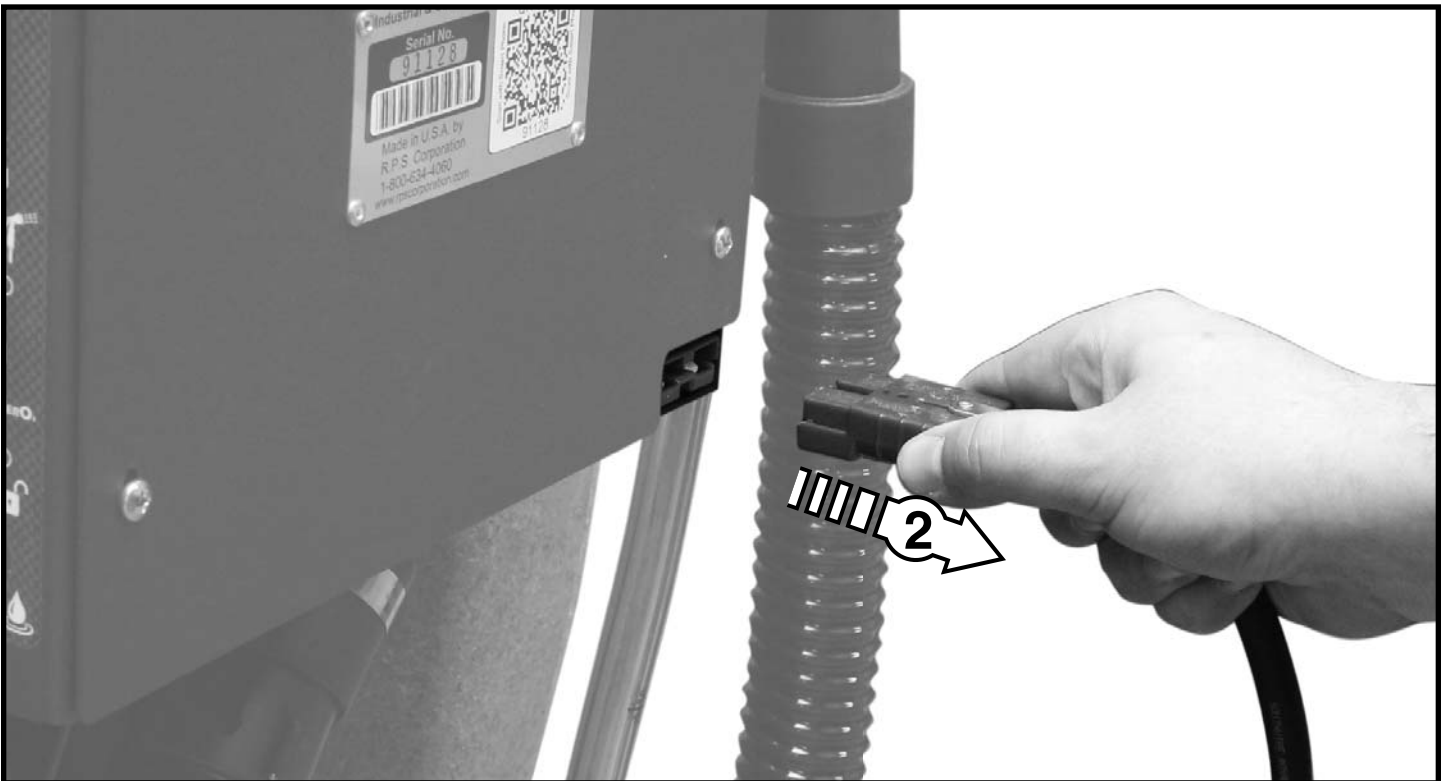

TRANSPORTATION - FORWARD





TRANSPORTATION - REVERSE

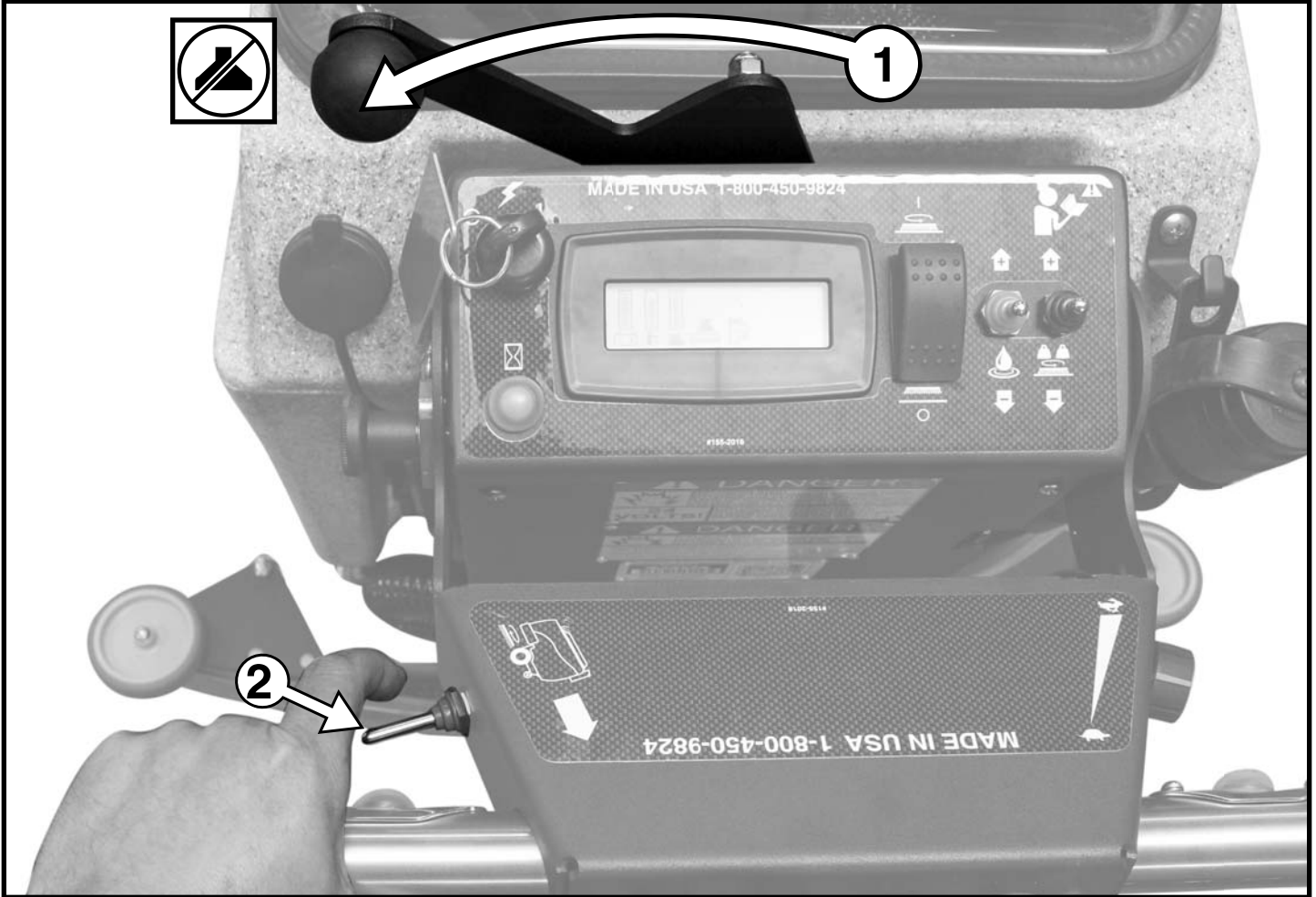

FILL SOLUTION TANK

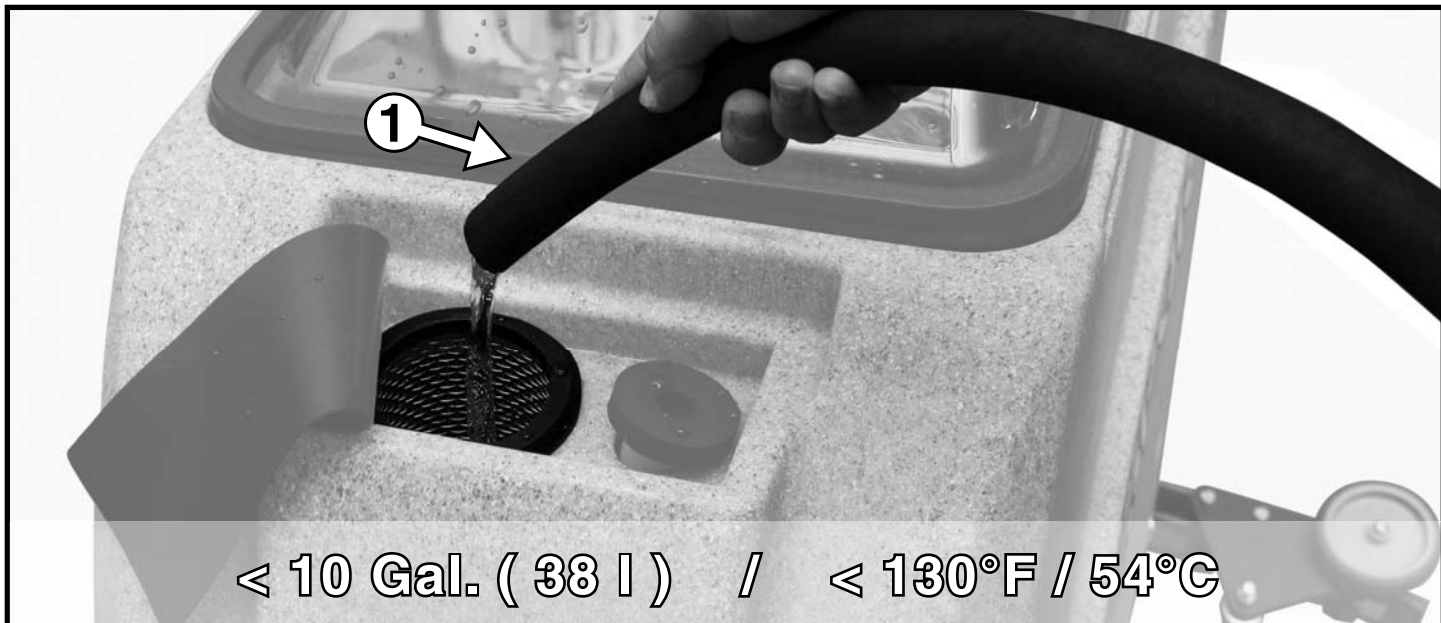

⚠ DANGER

EXPLOSION RISK! Flammable materials can cause an explosion or fire. Do NOT use flammable materials in Tank or pick up.

⚠ CAUTION

TO AVOID DAMAGE TO THIS MACHINE:

- Use APPROVED detergents only
- Water temperature must not exceed 130°F/54°C
- Do NOT use high-percentage Bleach mixture

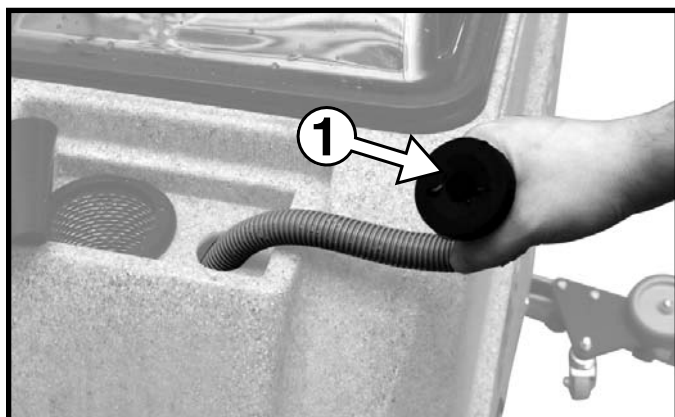



OPERATION - SCRUBbing

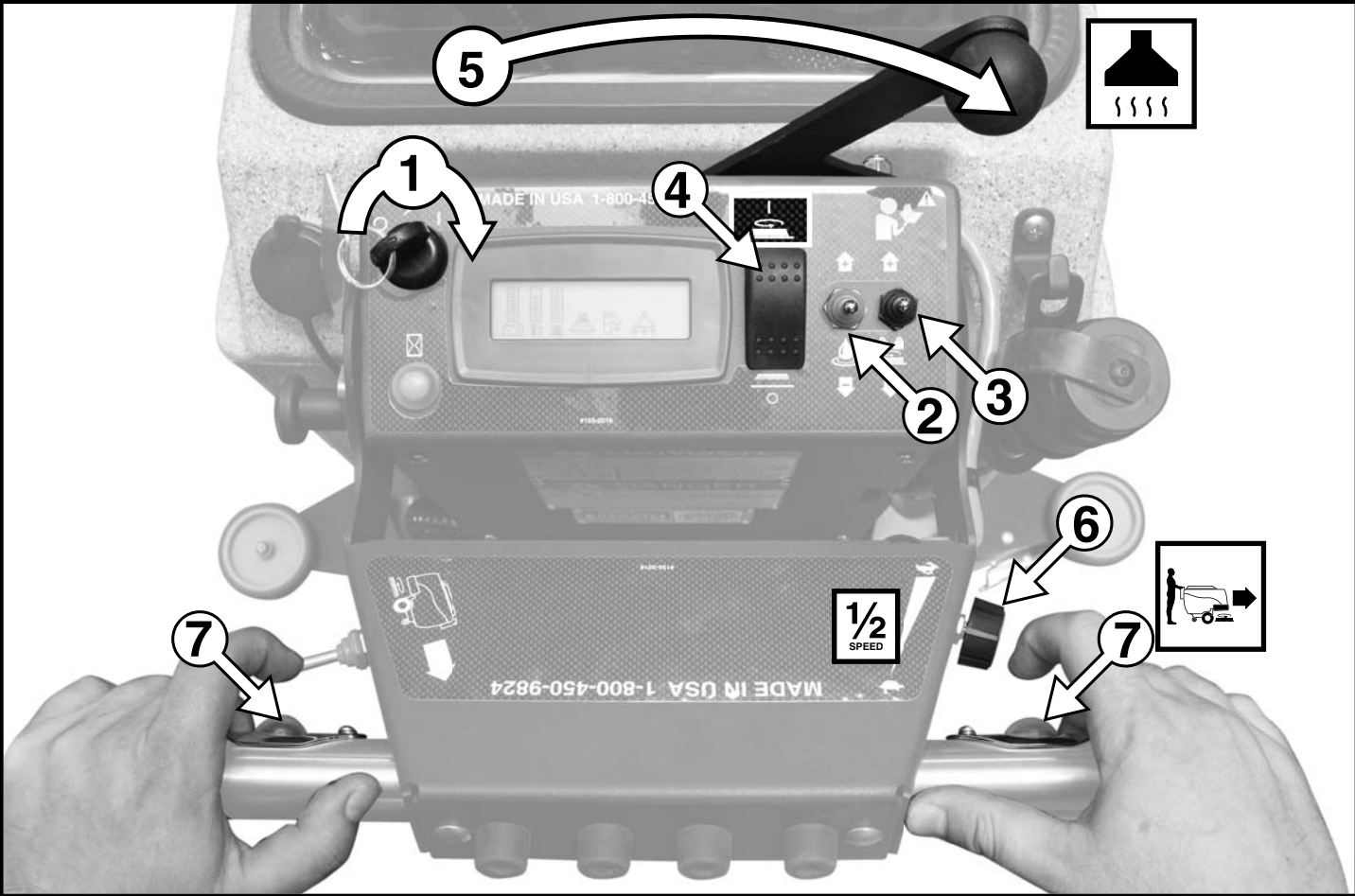

DRAINING RECOVERY TANK

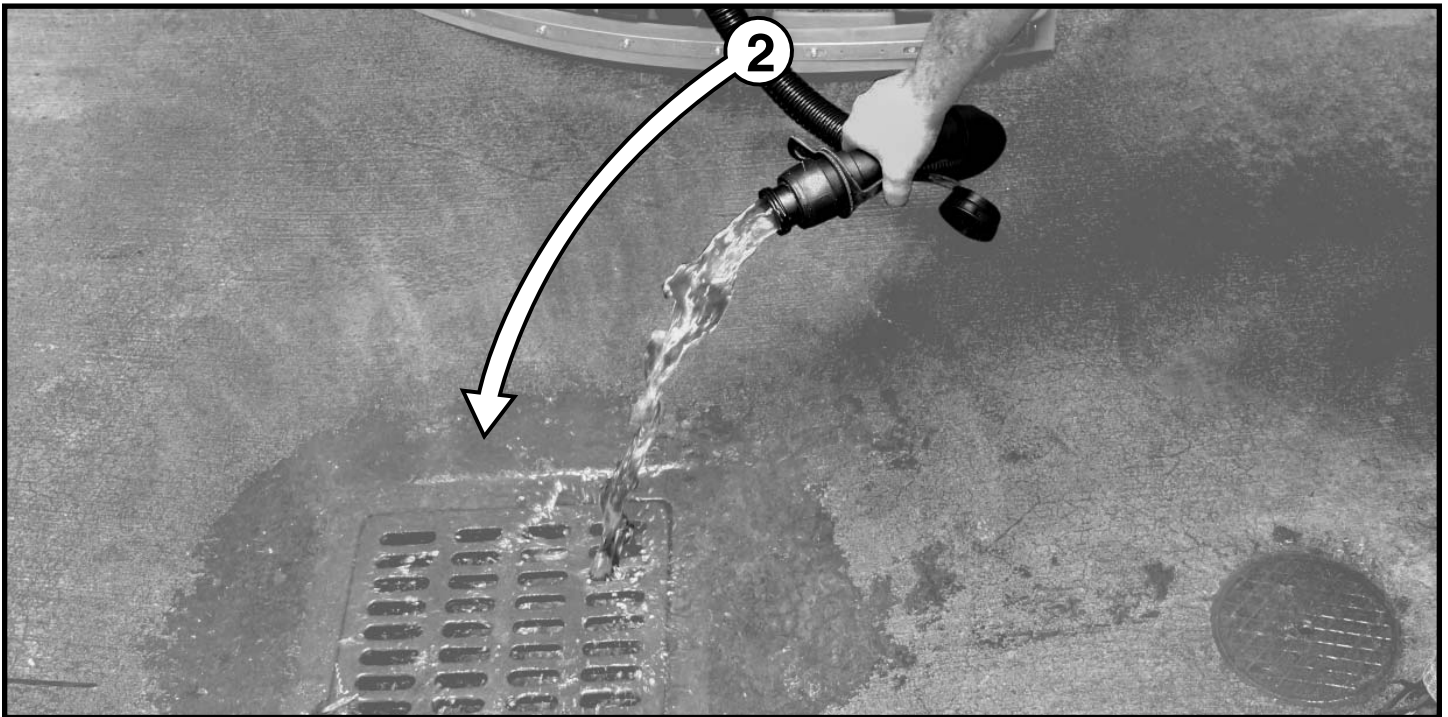
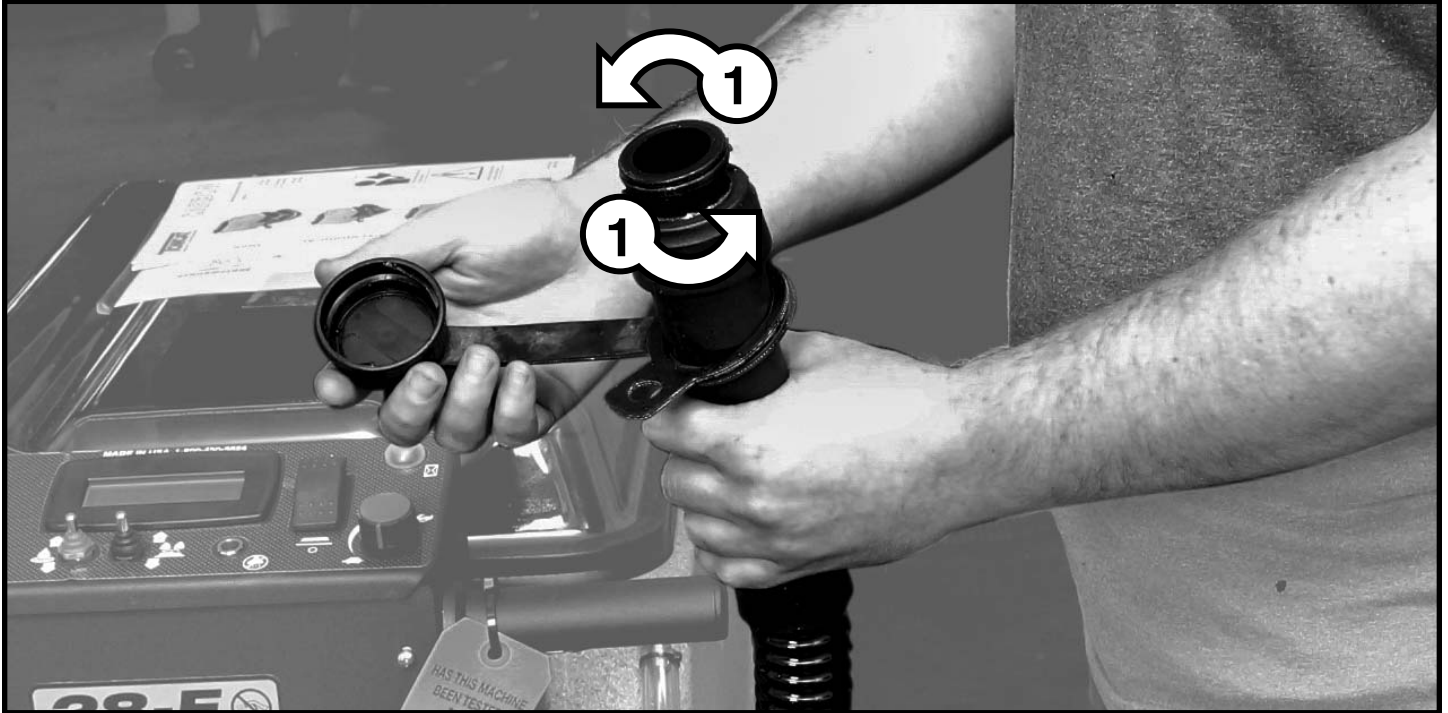
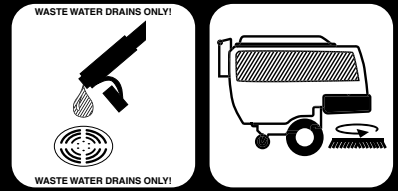

WASTE WATER DRAINS ONLY!



WASTE WATER DRAINS ONLY!



DRAINING SOLUTION TANK

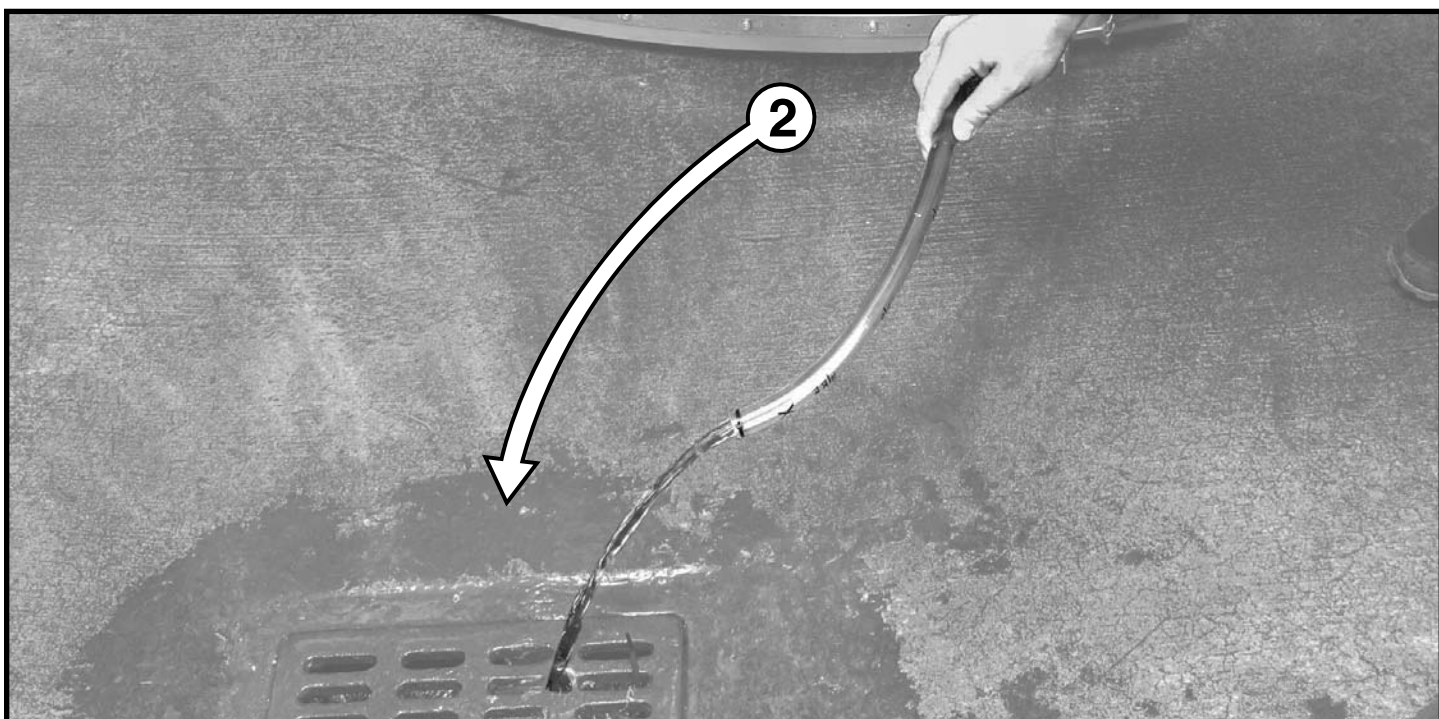

FLUSHING RECOVERY TANK

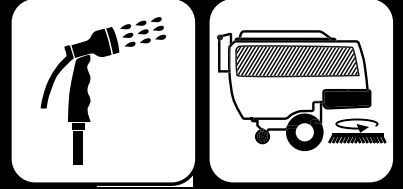



CLEAN DRAIN SAVER

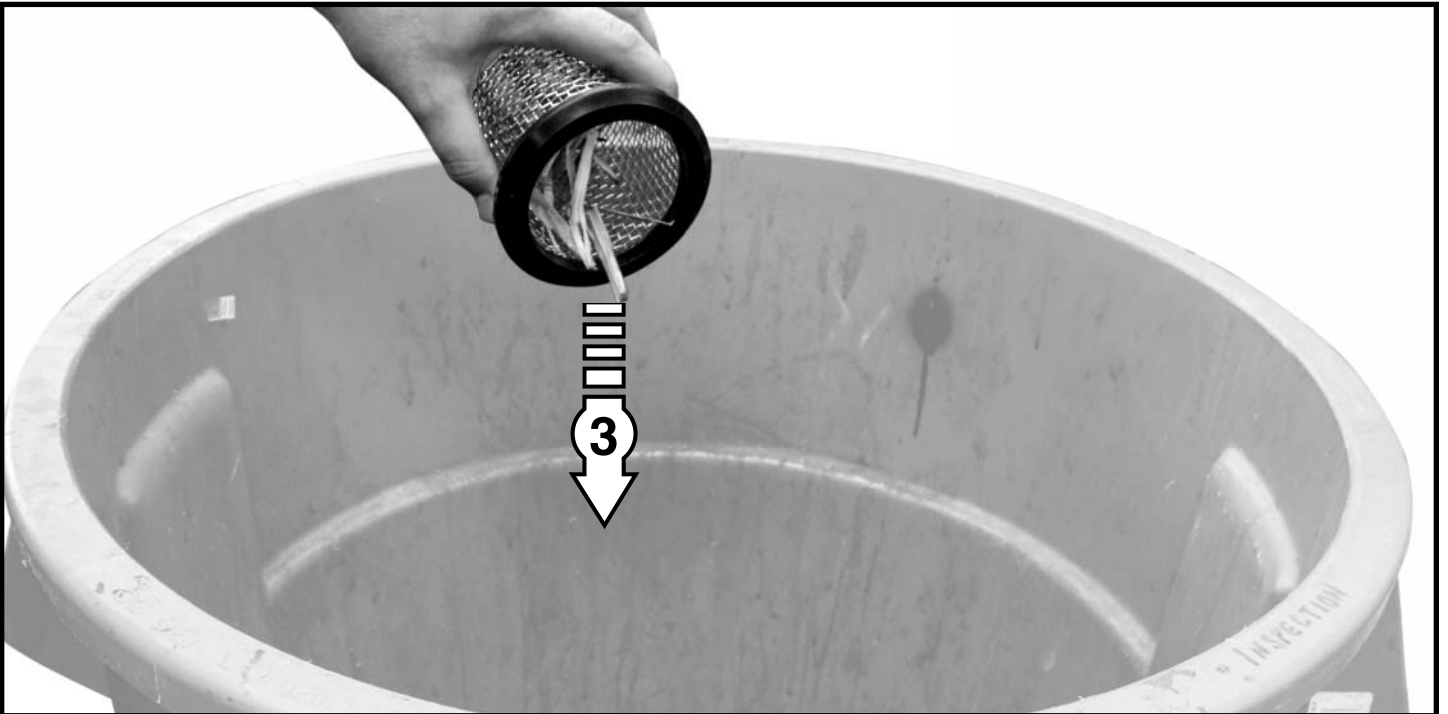

CLEAN CYLINDRICAL HOPPER

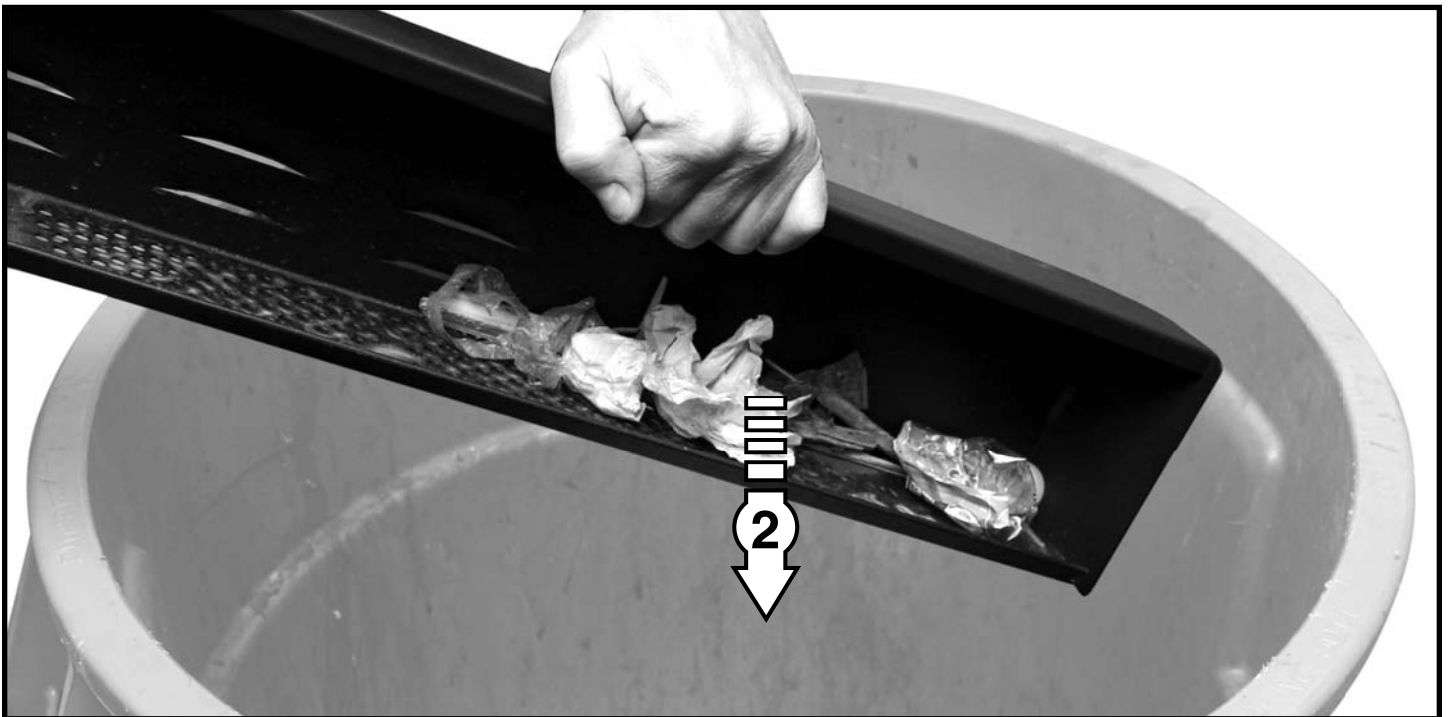
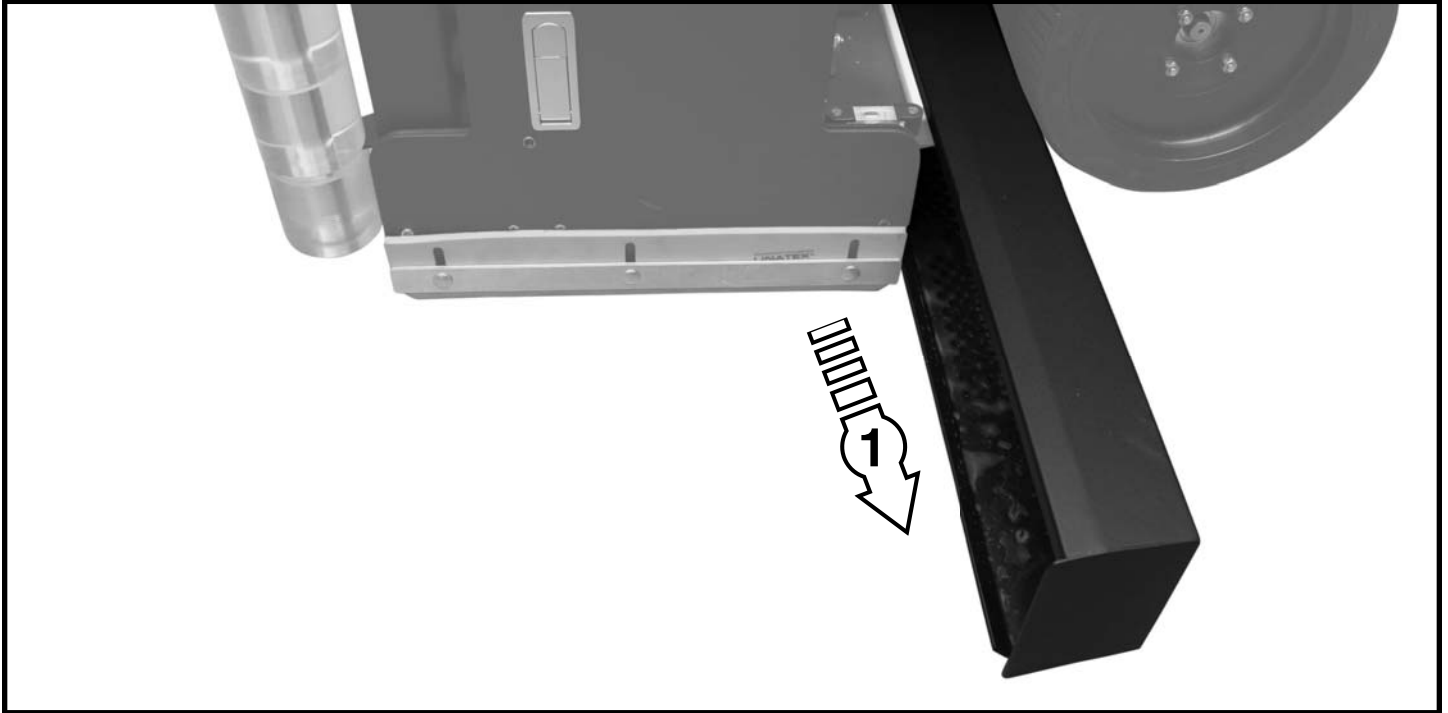

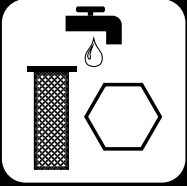

CLEAN VAC BOX SYSTEM

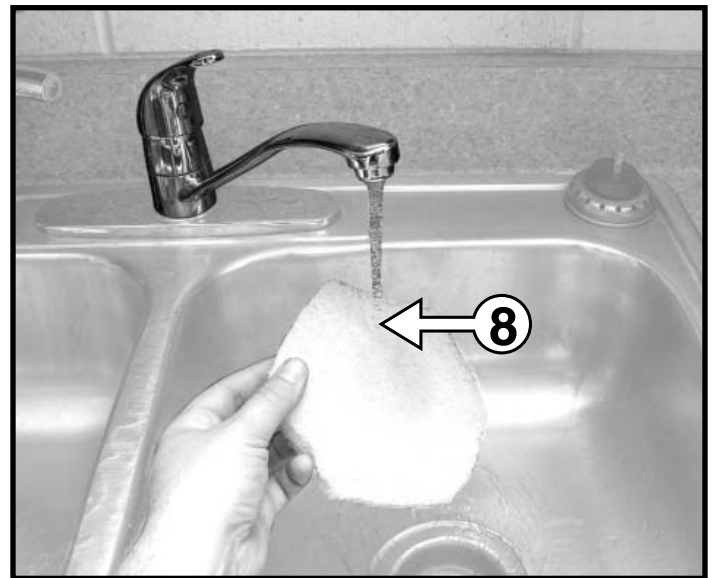
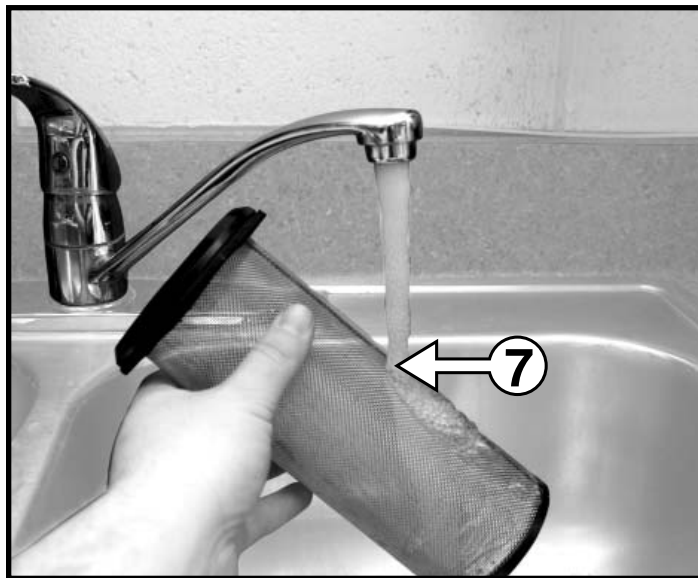
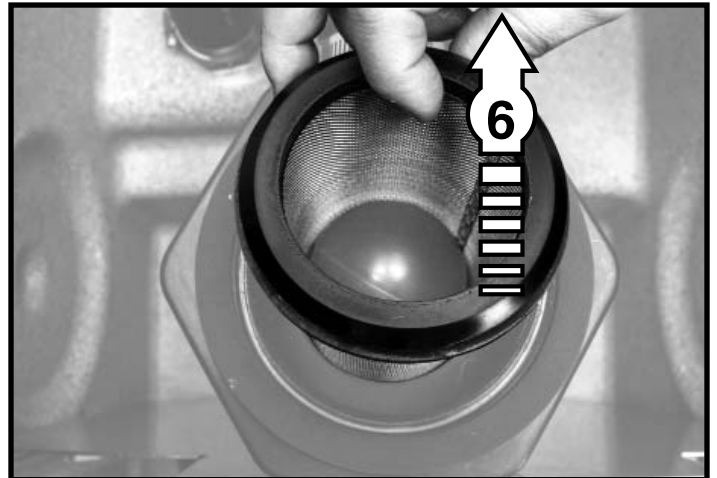
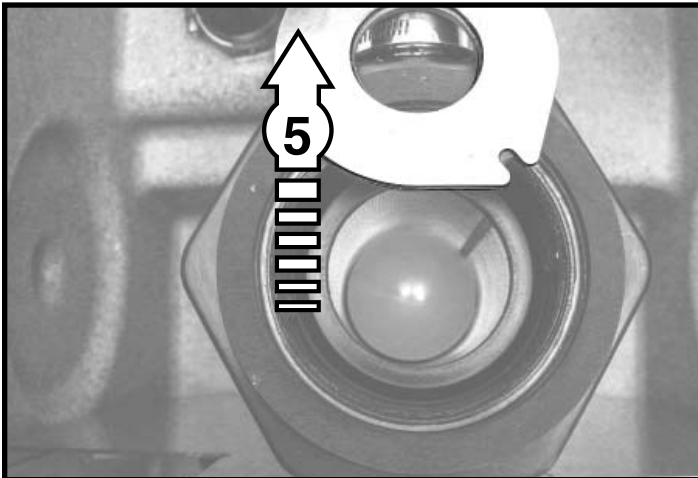
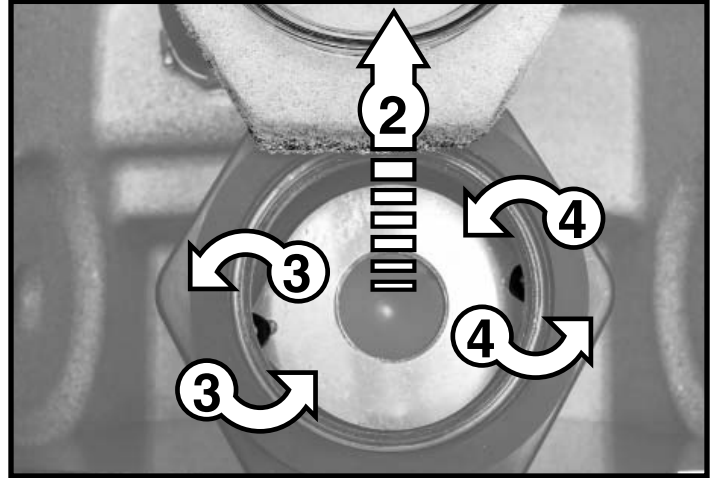
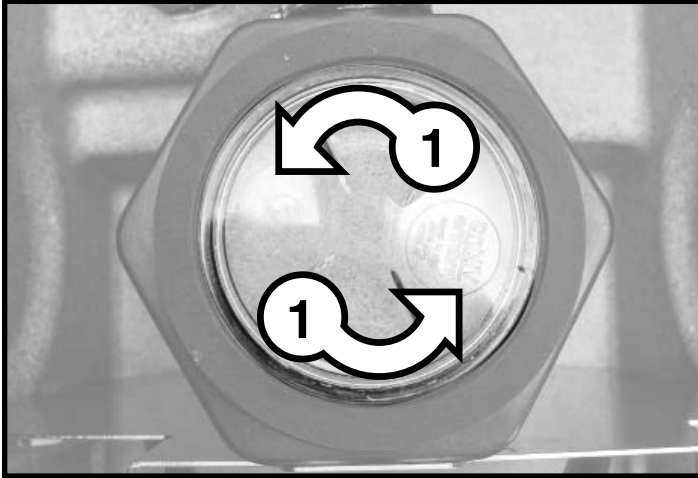

REMOVE DISK BRUSHES

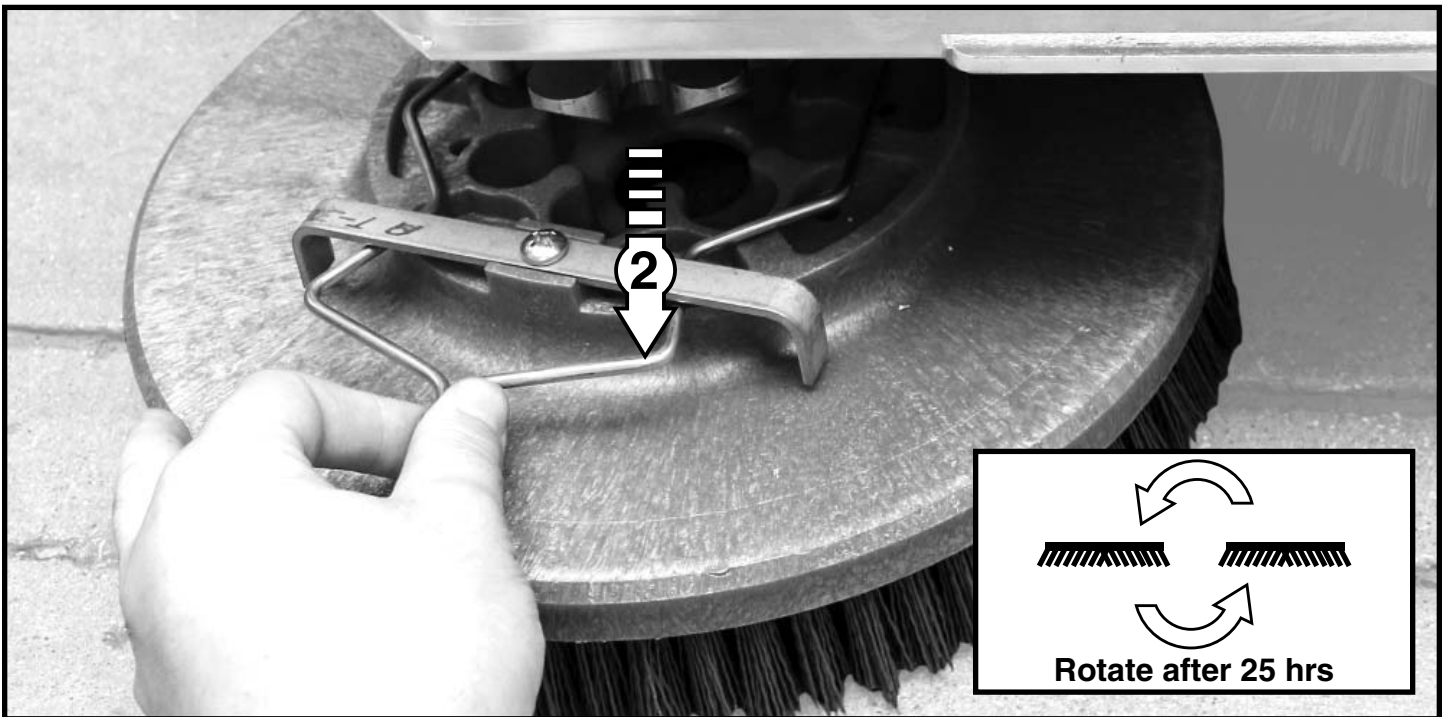

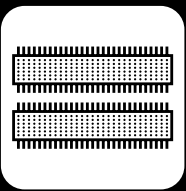

REMOVE CYLINDRICAL BRUSHES

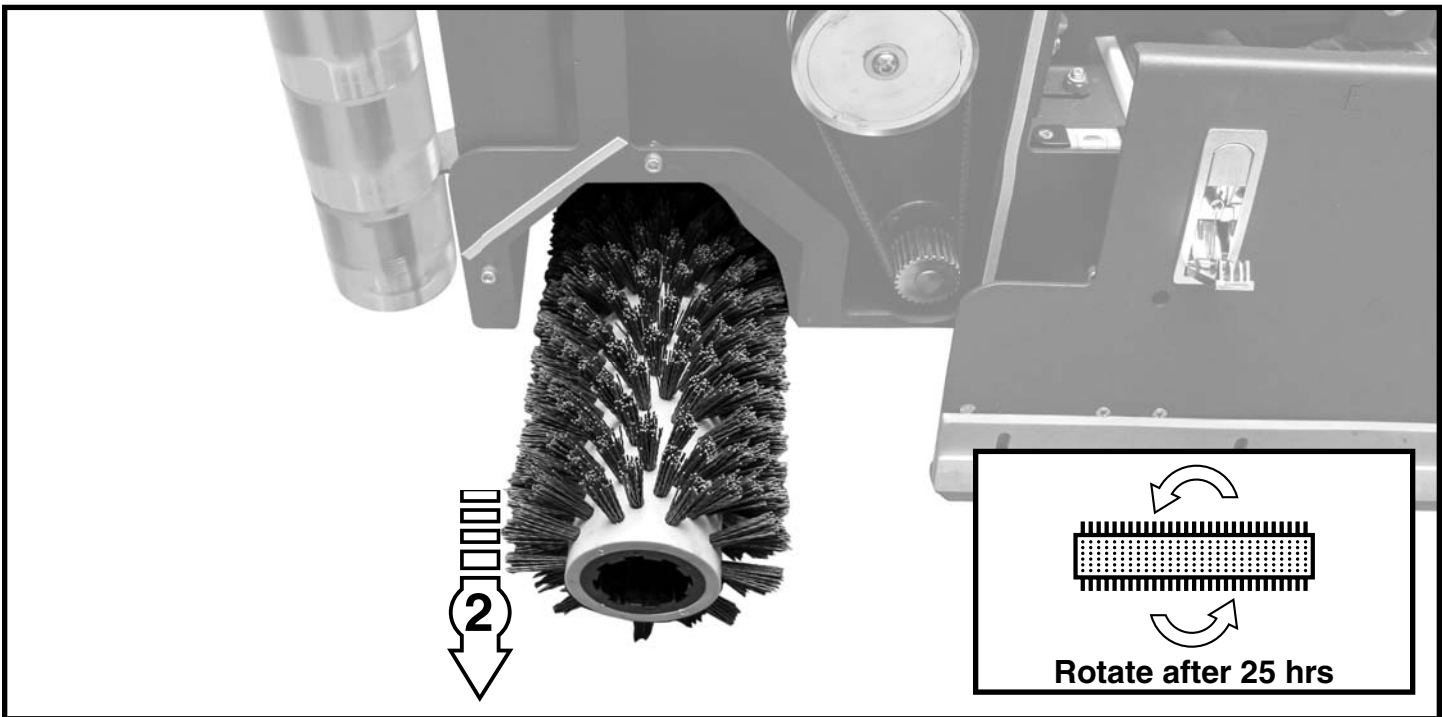
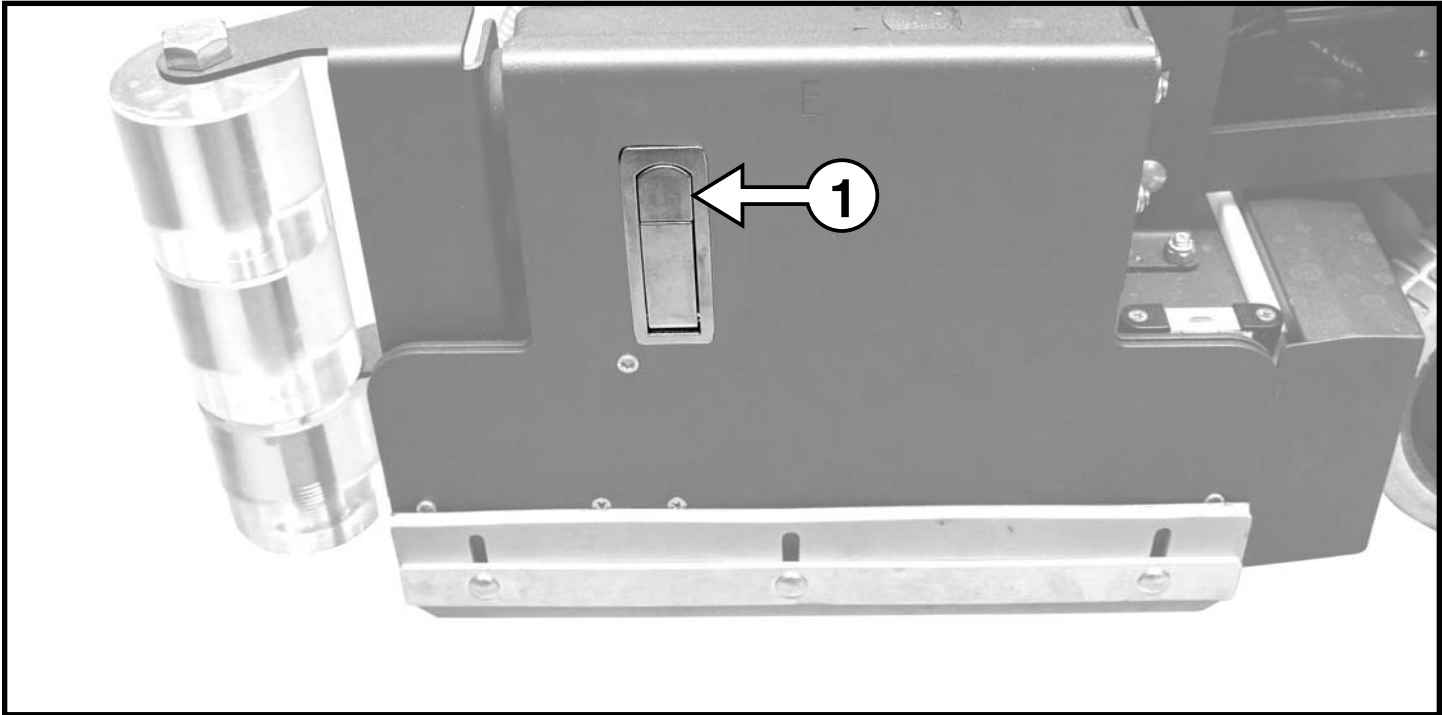

REMOVE EDGE PADS

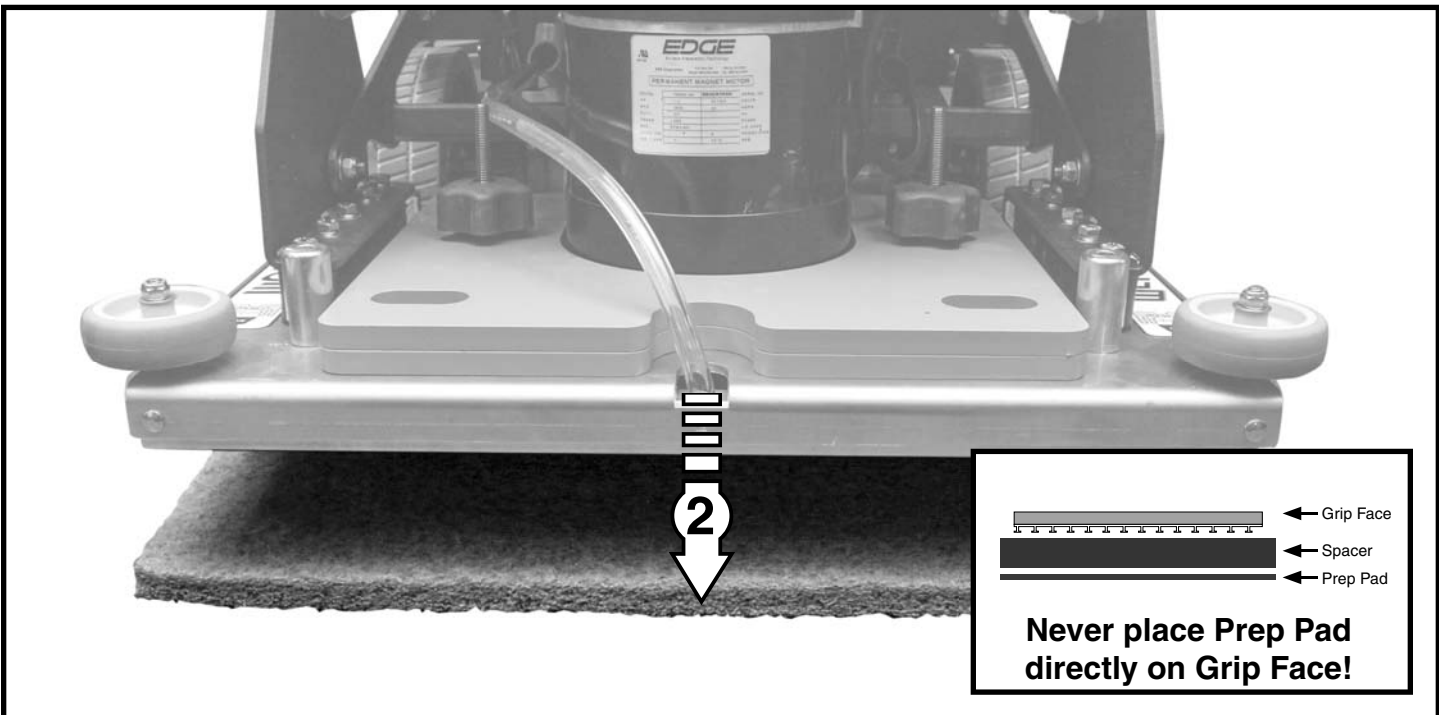
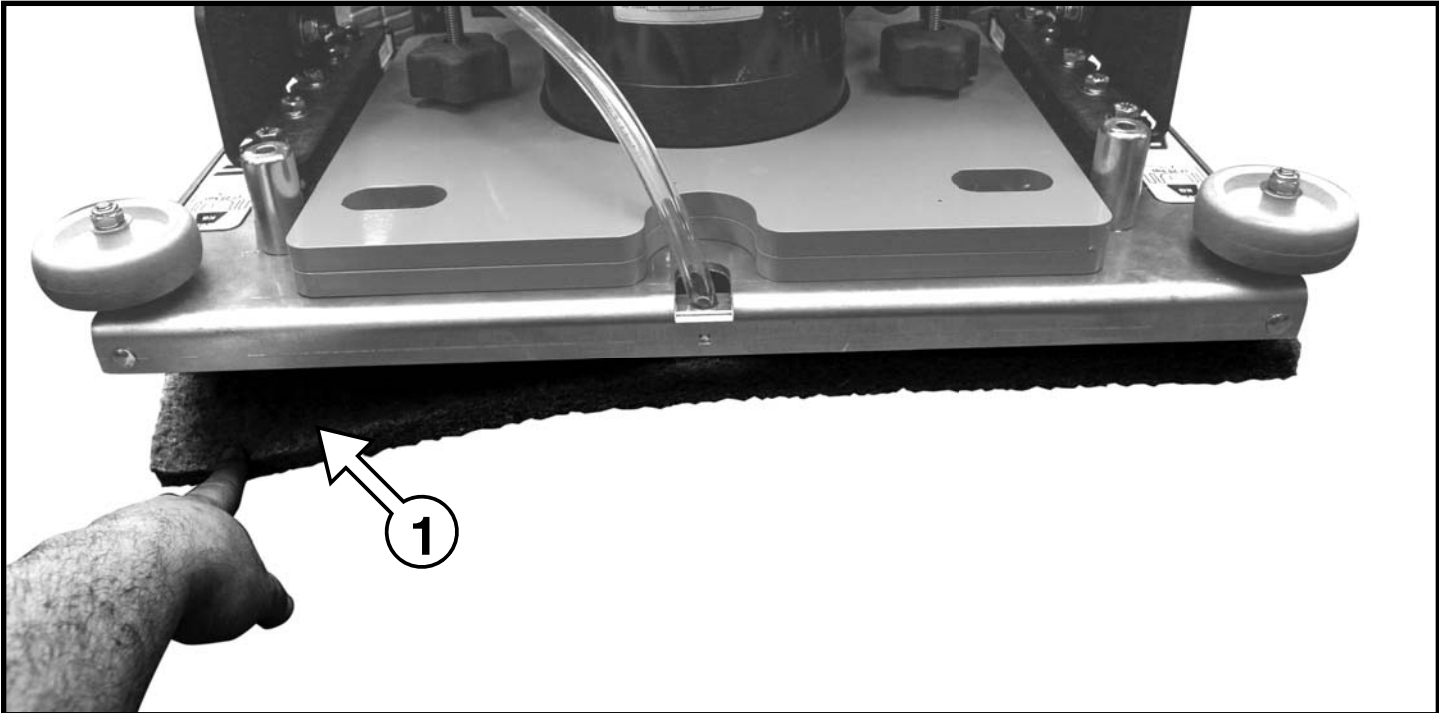
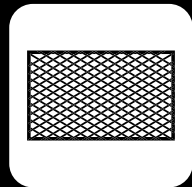

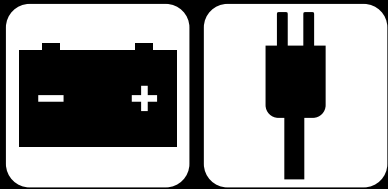

CHARGE BATTERIES



Please refer to OEM Charger Operating Instructions for more information.

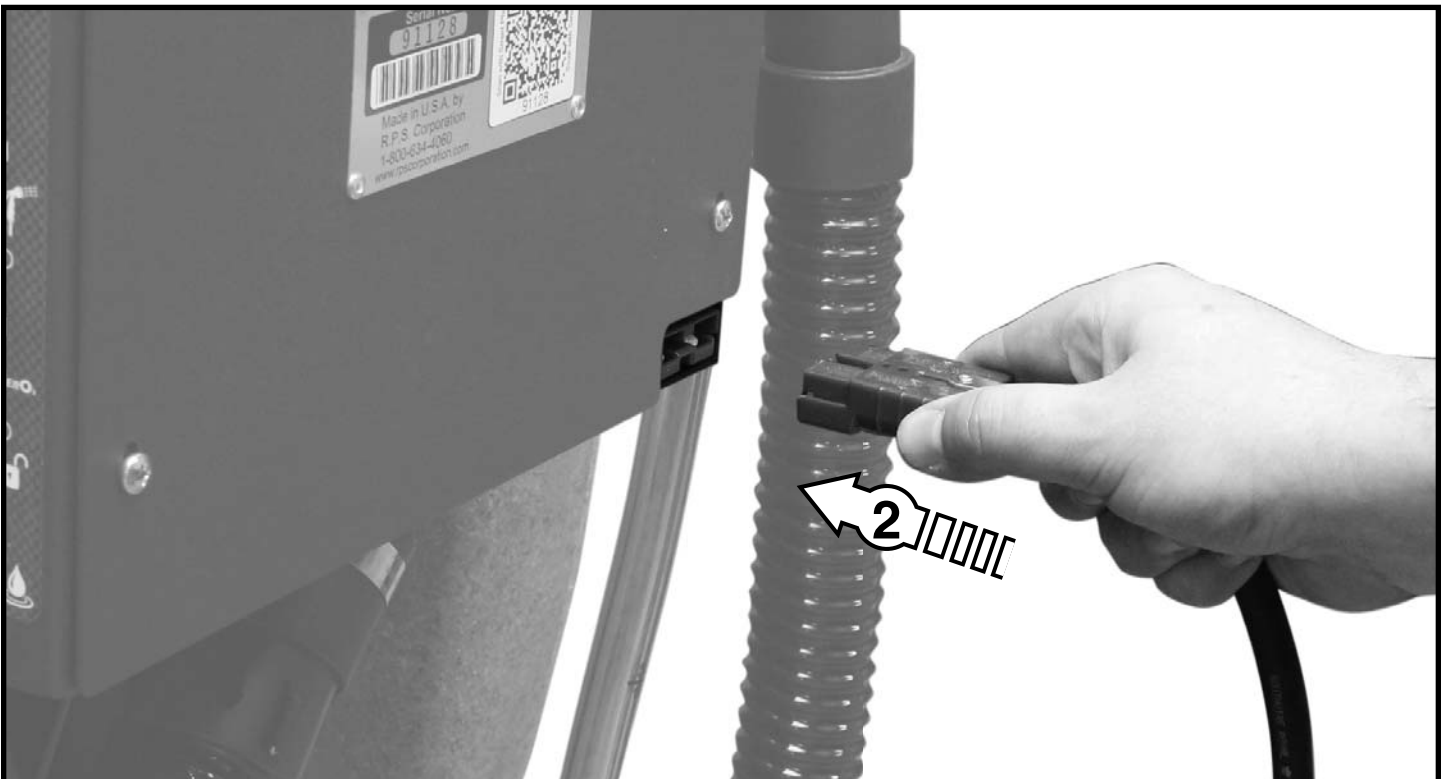

BATTERY CHARGERS

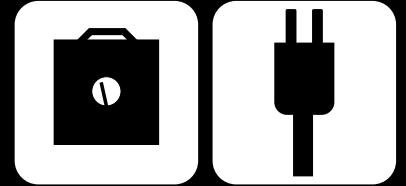

Console / WET / Domestic Chargers:

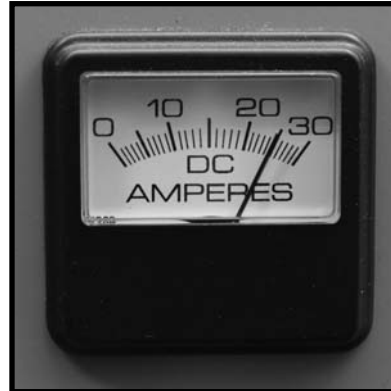

AC Power IN: 120VAC / 60Hz
DC Power OUT: 24VDC / 12A

Please refer to OEM Charger Operating Instructions for more information.



Onboard / AGM / International Chargers:



AC Power: 80-270VAC / 50-60Hz
DC Power OUT: 24VDC / 27A

Please refer to OEM Charger Operating Instructions for more information.



COMMON WEAR PARTS

ROUND DISK BRUSHES:

NOTICE

The ## in Disk Column Denotes Desk Pad Size: 13", 17" or 20"

BRUSHES	DISK	LEVEL
Super Grit	##-382SS	Very High
Tough Grit	##-382S	High
Midi Grit	##-382C	Medium
Light Grit	##-382PS	Moderate
Poly	##-382P	Light
Nylon	##-382N	Light
Tampico	##-382T	Light
Pad Driver	##-382D	
Diamond Driver	##-382DD	

ROUND DISK PADS:

NOTICE

The ## in Disk Column Denotes Desk Pad Size: 13", 17" or 20"

DISK PADS	DISK	LEVEL	COLOR
Super Black	##-422BB	Very High	Black
Black	##-422B	High	Black
Brown	##-422BR	High	Brown
Green	##-422G	Medium	Green
Blue	##-422BL	Moderate	Blue
Red	##-422R	Moderate	Red
White	##-422W	Light	White

CYLINDRICAL BRUSHES:

BRUSHES	MODEL 25" CYLINDRICAL	LEVEL
Tough Grit	236-697S	High
Midi Grit	236-697C	Medium
Light Grit	236-697PS	Moderate
Nylon	236-697N	Light
Tampico	236-697T	Light

EDGE PADS AND SCREENS:

DESCRIPTION	24"×14"	20"×14"
	SCRUBDECK	SCRUBDECK
White Pad	N / A	EDGE-4005
Red Pad	EDGE-2404	EDGE-4004
Blue Pad	EDGE-2403	EDGE-4003
Green Pad	EDGE-2402	EDGE-4002
Black Pad	EDGE-2401	EDGE-4001
White Driver Pad	N / A	EDGE-4025
Tile/Grout Renovator Pad	N / A	EDGE-4018
Microfiber Pad	N / A	EDGE-4036
Dominator HD Strip Pad	N / A	EDGE-4006
Maroon ECO Prep Pad	EDGE-2407	EDGE-4007
Remover Burnishing Pad	N / A	EDGE-4008
Porko Burnishing Pad	N / A	EDGE-4017
Velcro Pad	N / A	300-4023

EDGE GRIP FACE:

DESCRIPTION	PART#
20" Velcro Grip Face	300-1037
24" Velcro Grip Face	300-1038
20" & 24" Mighty Lok Grip Face	300-01037Z

SQUEEGEE BLADE KITS & COMPLETE SQUEEGEE ASSEMBLIES:

SQUEEGEE SIZE	17" DISK DECKS	20" DISK DECKS	26" DISK DECKS	25" CYL. DECKS	20" EDGE DECKS	24" EDGE DECKS
36" Squeegee	Standard	Standard	Standard	Standard	Standard	Standard
42" Squeegee	Optional	Optional	Optional	Optional	Optional	Optional

SQUEEGEE SIZE	LINATEX BLADE KIT	GUM RUBBER BLADE KIT	URETHANE BLADE KIT	COMPLETE SQUEEGEE ASSEMBLIES
36" Squeegee	36-770L	36-770G	36-770U	36-7180
42" Squeegee	42-770L	42-770G	42-770U	42-7180

SQUEEGEE MATERIAL:	USED FOR:
LINATEX	Provides best wear and tear resistance. Not designed for use with harsh chemicals.
URETHANE	Provides best resistance when dealing with harsh chemicals, oils, fuels, etc.
GUM	Provides best drying performance on rough/grouted floor types by sealing over irregularities. Short life.

NOTICE

Squeegee blade kits include (1) Rear Blade, (1) Front Blade, and (2) Caster Wheels with hardware.

NOTICE

Squeegee Assemblies (complete) listed above all come with Linatex blades.

NOTICE

Size is stamped into the top of the painted steel squeegee body on all squeegee's.

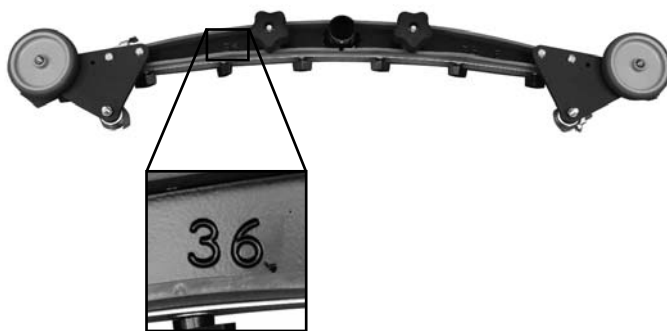

BLANK
THIS PAGE WAS INTENTIONALLY LEFT BLANK

BLANK
THIS PAGE WAS INTENTIONALLY LEFT BLANK

TOMCAT[®]

1711 South Street

Racine, WI 53404

www.tomcatequip.com

Tel. US: 800-450-9824

Tel. Int: (+001) 262-681-6470